



TW
Surgical

CARDIO



**UK
CA CE**



TW Surgical

Treasure Wright (U.K.) Ltd.



www.twrightmedical.com



info@twrightmedical.com

RAIL CLAMPS + RAIL ATTACHMENTS

RETRACTOR COMPONENTS



ELITE III RAIL CLAMPS (CURRENT)

REF	ITEM DESCRIPTION	Code
A	Elite III Rail Clamp 11" (25cm) with 1 Cam Joint	TWS 34100
	Elite III Rail Clamp 16" (41cm) with 1 Cam Joint	TWS 34101



OLDER GENERATION ELITE RAIL CLAMP

REF	ITEM DESCRIPTION	Code
c	Elite III Rail Clamp 11" (25cm) with 1 Cam Joint	TWS 34110
	Elite II Rail Clamp 16" (41cm) with 1 Cam Joint	TWS 34111
	Elite II Rail Clamp 18" (45cm) with 1 Cam Joint	TWS 34112
	Elite II Rail Clamp 11" (25cm) with one 3/8" Cam Joint	TWS 34113
	Elite II Rail Clamp 18" (45cm) with 2 Cam Joints	TWS 34114
	Elite II Rail Clamp 16" (41cm) with 2 Cam Joints	TWS 34115
	Elite II Rail Clamp 22" (55cm) with 1 Cam Joint	TWS 34116
	Elite II Rail Clamp 22" (55cm) with 2 Cam Joints	TWS 34117
	Elite II Rail Clamp 26" (65cm) with 1 Cam Joint	TWS 34118
	Elite II Rail Clamp 26" (65cm) with 2 Cam Joints	TWS 34119



ELITE III RAIL CLAMPS (CURRENT)

REF	ITEM DESCRIPTION	Code
B	Elite III Rail Clamp 18" (45cm) with 1 Cam Joint	TWS 34102
	Elite III Rail Clamp 11" (25cm) with 1 (3/8") Cam Joint	TWS 34103
	Elite III Rail Clamp 18" (45cm) with 2 Cam Joints	TWS 34104
	Elite III Rail Clamp 16" (41cm) with 2 Cam Joints	TWS 34105
	Elite III Rail Clamp 22" (55cm) with 1 Cam Joint	TWS 34106
	Elite III Rail Clamp 22" (55cm) with 2 Cam Joints	TWS 34107
	Elite III Rail Clamp 26" (65cm) with 1 Cam Joint	TWS 34108
	Elite III Rail Clamp 26" (65cm) with 2 Cam Joints	TWS 34109



INFINITE HEIGHT RAIL CLAMPS (IHRC) (CURRENT)

REF	ITEM DESCRIPTION	Code
D	IHRC with 1 Cam Joint 11" - 22" 43902IRC	TWS 34120
	IHRC with 2 Cam Joints 11" - 22" 43903IRC	TWS 34121

RAIL CLAMPS + RAIL ATTACHMENTS

RETRACTOR COMPONENTS



OLDER GENERATION IHRC'S

REF	ITEM DESCRIPTION	Code
E	IHRC with 1 Cam Joint 11" - 22"	TWS 34122
	IHRC with 2 Cam Joints 11" - 22"	TWS 34123



OLDER GENERATION RAIL CLAMPS

REF	ITEM DESCRIPTION	Code
	Power Rail Clamp	TWS 34124



TABLE ADAPTER (CURRENT)

REF	ITEM DESCRIPTION	Code
	Jackson Spine Frame Adapter	TWS 34125



RAIL EXTENDERS (CURRENT)

REF	ITEM DESCRIPTION	Code
F	Rail Extender 15" with 1 Power Rail Clamp	TWS 34126
	Rail Extender 15" with 1 Power Rail Clamp	TWS 34127
	Rail Extender 20" with 1 Power Rail Clamp	TWS 34128

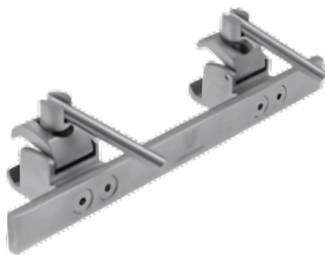

RAIL EXTENDERS (CURRENT)

REF	ITEM DESCRIPTION	Code
G	Rail Extender 14" with 2 Power Rail Clamps Offset	TWS 34129
	Rail Extender 22" with 2 Power Rail Clamps	TWS 34130

CROSSBARS + LATERAL ARMS + ABDOMINAL BARS + HINGED RING

RETRACTOR COMPONENTS



UNILATERAL CROSSBARS (CURRENT)

REF	ITEM DESCRIPTION	Code
A	Crossbar with 2 Cam III Joints 24" (11" x 13")	TWS 34131
	Crossbar with 2 Cam III Joints 24" (8" x 16")	TWS 34132



UNILATERAL CROSSBARS (CURRENT)

REF	ITEM DESCRIPTION	Code
B	Crossbar with 2 Cam III Joints (7" x 19 1/2") (in Hip System)	TWS 34133



UNILATERAL CROSSBARS (CURRENT)

REF	ITEM DESCRIPTION	Code
C	Crossbar with 1 Cam III Joint Mini-Incision (in Kidney System)	TWS 34134



OLDER GENERATION UNILATERAL CROSSBARS

REF	ITEM DESCRIPTION	Code
D	Crossbar with 2 Cam Joints 24" (11" x 13")	TWS 34135
	Crossbar with 2 Cam Joints 24" (8" x 16")	TWS 34136
	Crossbar with 2 Adjustable Cam Joints 24"	TWS 34137
	Crossbar with 2 Cam Joints (7" x 19 1/2") (in Hip System)	TWS 34138
	Crossbar with 1 Cam Joint Mini-Incision (in Kidney System)	TWS 34139



BILATERAL CROSSBARS (CURRENT)

REF	ITEM DESCRIPTION	Code
E	Bilateral Crossbar 7 1/4" x 13 1/2" x 7 1/4"	TWS 34140



OLDER GENERATION BILATERAL CROSSBARS

REF	ITEM DESCRIPTION	Code
G	34" Bilateral Crossbar Hinged 11" x 8 1/2" x 11"	TWS 34141
	41 1/2" Bilateral Crossbar Hinged 14" x 10" x 14"	TWS 34142
	Bilateral Crossbar with 2 Joints	TWS 34143



BILATERAL CROSSBARS (CURRENT)

REF	ITEM DESCRIPTION	Code
F	34" Bilateral Crossbar Hinged 11 1/2" x 8 1/2" x 11 1/2"	TWS 34144
	41 1/2" Bilateral Crossbar Hinged 14 1/2" x 10" x 14 1/2"	TWS 34145



ANGLED LATERAL ARMS (CURRENT)

REF	ITEM DESCRIPTION	Code
H	26" (6" x 20") (15cm x 50cm)	TWS 34146



ANGLED LATERAL ARMS (CURRENT)

REF	ITEM DESCRIPTION	Code
J	24" (8" x 16") (20cm x 40cm)	TWS 34148
	20" (10" x 10") (25cm x 25cm)	TWS 34149



ANGLED LATERAL ARMS (CURRENT)

REF	ITEM DESCRIPTION	Code #
L	12" (6" x 6") (15cm x 15cm)	TWS 34152
	19" (12" x 7") 3/8" Rod	TWS 34153



ANGLED LATERAL ARMS (CURRENT)

REF	ITEM DESCRIPTION	Code
N	Double Angled Arm 28" (7 1/4" x 13 1/2" x 7 1/4")	TWS 34156

OLDER GENERATION ANGLED LATERAL ARMS

ITEM DESCRIPTION	Code
12" (30cm)	TWS 34160
12" (30cm)	TWS 34161
24" (61cm)	TWS 34162



ANGLED LATERAL ARMS (CURRENT)

REF	ITEM DESCRIPTION	Code
I	24" (11" x 13") (28cm x 33cm)	TWS 34147



ANGLED LATERAL ARMS (CURRENT)

REF	ITEM DESCRIPTION	Code
K	18" (8" x 10") (20cm x 25cm)	TWS 34150
	17" (7" x 10") (25cm x 18cm)	TWS 34151



ANGLED LATERAL ARMS (CURRENT)

REF	ITEM DESCRIPTION	Code
M	17" (7" x 10") 3/8" Rod	TWS 34154
	Double Angled Arm 22" (7" x 9" x 7")	TWS 34155



LOWER ABDOMINAL BARS (CURRENT)

REF	ITEM DESCRIPTION	Code
N	Lower Abdominal Bar 14" x 6"	TWS 34157
	Lower Abdominal Bar 10" x 8"	TWS 34158
	Lower Abdominal Bar 10" x 6"	TWS 34159



EXTENSION ARMS (CURRENT)

REF	ITEM DESCRIPTION	Code
A	Extension Arm 7 1/2" x 8 1/2" x 7 1/2" (in Kidney System)	TWS 34163



EXTENSION ARMS (CURRENT)

REF	ITEM DESCRIPTION	Code
C	Extension Arm 12" with Hinge Joint	TWS 34165
	3/8" Extension Arm 12" with Hinge Joint	TWS 34166



EXTENSION ARMS (CURRENT)

REF	ITEM DESCRIPTION	Code
F	Angled Closure Arm 13" (6 1/2"x 6 1/2")	TWS 34170
	Angled Closure Arm 18" (9"x 9")	TWS 34171
	Angled Closure Arm 21" (10 1/2"x 10 1/2")	TWS 34172



EXTENSION ARMS (CURRENT)

REF	ITEM DESCRIPTION	Code
H	Extension Arm 14" with Clip Joint	TWS 34174
	Extension Arm 16" with Clip Joint	TWS 34175
	Extension Arm 20" with Clip Joint	TWS 34176
	Extension Arm with Fixed Hinge Joint	TWS 34177



EXTENSION ARMS (CURRENT)

REF	ITEM DESCRIPTION	Code
B	Extension Arm 12" with Spring Hinge Joint	TWS 34164



EXTENSION ARMS (CURRENT)

REF	ITEM DESCRIPTION	Code
D	Extension Arm 12" with Cam Latch Joint	TWS 34167



EXTENSION ARMS (CURRENT)

REF	ITEM DESCRIPTION	Code
E	Hinged Extension Arm 12" x 12" (30cm x 30cm)	TWS 34168
	Angled Closure Arm 9" (4 1/2"x 4 1/2")	TWS 34169



EXTENSION ARMS (CURRENT)

REF	ITEM DESCRIPTION	Code
G	Extension Arm 14" with Cam Latch Mount	TWS 34173

EXTENSION ARMS + STRAIGHT ARMS + 90° RODS + UPRIGHT ARMS

RETRACTOR COMPONENTS



EXTENSION ARMS (CURRENT)

REF	ITEM DESCRIPTION	Code
I	S-Lock Articulating Arm Small 15 1/2"	TWS 34178
	Quick Angle Articulating Arm 12" x 21"	TWS 34179



STRAIGHT ARMS (CURRENT)

REF	ITEM DESCRIPTION	Code
K	Straight Arm 12" (30cm)	TWS 34181



STRAIGHT ARMS (CURRENT)

REF	ITEM DESCRIPTION	Code
M	Straight Arm with 1 Cam Joint 20" (50cm)	TWS 34184

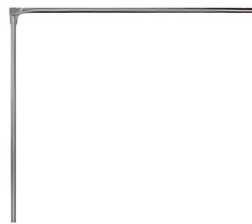

90° ROD (CURRENT) *

REF	ITEM DESCRIPTION	Code
S	90° Collapsible Rod with Grooves	TWS 34190

OLDER GENERATION 90° RODS

REF	ITEM DESCRIPTION	Code
	90° Collapsible Rod with 1 Cam Joint 14" x 19"	TWS 34191
	90° Collapsible Rod with 1 Cam Joint 17" x 19"	TWS 34192
	90° Collapsible Rod with 1 Cam Joint 21" x 21"	TWS 34193
	90° Collapsible Rod 14" x 19"	TWS 34194
	90° Collapsible Rod 17" x 19"	TWS 34195
	90° Collapsible Rod 21" x 21"	TWS 34196
	90° Rigid Rod 14" x 19"	TWS 34197
	90° Rigid Rod 17" x 19"	TWS 34198
	90° Rigid Rod 21" x 21"	TWS 34199
	90° Rigid Rod 10" x 20"	TWS 34200
	Extension Arm 90° 10" x 6"	TWS 34201



EXTENSION ARMS (CURRENT)

REF	ITEM DESCRIPTION	Code
J	Clamp Articulating Arm Straight 31"	TWS 34180



STRAIGHT ARMS (CURRENT)

REF	ITEM DESCRIPTION	Code
L	Straight Arm 20" (50cm)	TWS 34182
	Straight Arm with 1 Cam Joint 18"	TWS 34183

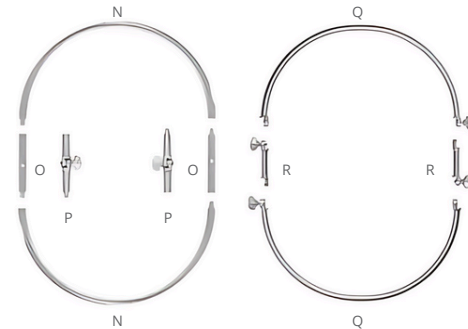

RINGS (CURRENT)

REF	ITEM DESCRIPTION	Code
N	Ring Frame Half 13 1/2" (2 required for use)	TWS 34185
O	Ring Extension 4"	TWS 34186
P	Ring Extension Hinged 4"	TWS 34187
Q	Ring Half Hinged 14 1/2" (2 required for use.)	TWS 34188
R	Ring Extension 3" (2 required for use.)	TWS 34189



OLDER GENERATION UPRIGHT ARMS

REF	ITEM DESCRIPTION	Code
T	Upright Arm 20"	TWS 34190
	Upright Arm with Universal Joint 20"	TWS 341911

BIG-BIG JOINTS

RETRACTOR COMPONENTS

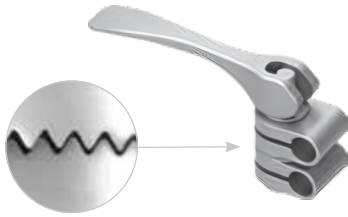

CAM III SERRATED SLIDE-ON JOINT (CURRENT) *

REF	ITEM DESCRIPTION	Code
I	Cam III Serrated Slide-on Joint ½" x ½"	TWS 34202

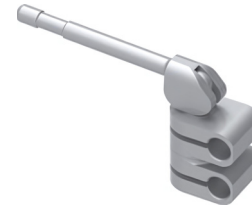

CAM I SLIDE-ON JOINT (CURRENT)

REF	ITEM DESCRIPTION	Code
I	Cam I Slide-on Joint ½" x ½"	TWS 34203



OLDER GENERATION CAM II SLIDE-ON JOINT

ITEM DESCRIPTION	Code
Cam II Slide-on Joint ½" x ½"	TWS 34204

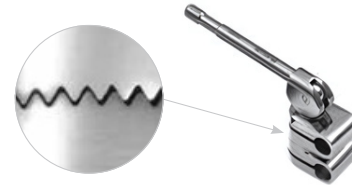

OLDER GEN. CAM I SERRATED SLIDE-ON JOINT *

ITEM DESCRIPTION	Code
Cam I Serrated Slide-on Joint ½" x ½"	TWS 34205



OLDER GENERATION LATCH CAM JOINT

ITEM DESCRIPTION	Code
Latch Cam Joint ½" x ½"	TWS 34206



OLDER GENERATION SLIDE-ON JOINT

ITEM DESCRIPTION	Code
Slide-on Joint ½" x ½"	TWS 34207



OLDER GENERATION LATCH JOINT

ITEM DESCRIPTION	Code
Latch Joint ½" x ½"	TWS 34208



OLDER GENERATION ONE PIECE UNIVERSAL JOINT

ITEM DESCRIPTION	Code
Hinged ½" x ½"	TWS 34209



OLDER GENERATION SERRATED UNIVERSAL JOINT *

ITEM DESCRIPTION	Code
Slide-on ½" x ½"	TWS 34210



UNIVERSAL SLIDE-ON JOINT (CURRENT)

ITEM DESCRIPTION	Code
Slide-On Joint ½" x ¼"	TWS 34212



UNIVERSAL CLIP-ON JOINT (CURRENT)

ITEM DESCRIPTION	Code
Clip-On Joint ½" x ¼"	TWS 34213



CAM II CLIP-ON PINCH JOINT (CURRENT)

ITEM DESCRIPTION	Code
Cam II Clip-On Pinch Joint ½" x ¼"	TWS 34214



UNIVERSAL HINGE JOINT (CURRENT)

ITEM DESCRIPTION	Code
One Piece Universal Hinge Joint ½" x ¼"	TWS 34215



UNIVERSAL LATCH JOINT (CURRENT)

ITEM DESCRIPTION	Code
Screw Down Universal Latch Joint ½" x ¼"	TWS 34216



UNIVERSAL SLIDE-ON JOINT (CURRENT)

ITEM DESCRIPTION	Code
Universal Slide-On Joint Reversed ¼" x ½"	TWS 34217



OLDER GENERATION CAM II CLIP-ON JOINT

ITEM DESCRIPTION	Code
Cam II Low Profile Clip-On Joint ½" x ¼"	TWS 34218

BIG-LITTLE JOINTS + RETRACTOR HANDLES + ACCESSORIES

RETRACTOR COMPONENTS



OLDER GENERATION CAM II SLIDE-ON JOINT

ITEM DESCRIPTION	Code
Cam II Low Profile Slide-On Joint ½" x ¼"	TWS 34219



OLDER GENERATION CAM I JOINTS

ITEM DESCRIPTION	Code
Cam I Slide-On Joint ½" x ¼"	TWS 34220
Cam I Joint ½" x 3/8"	TWS 34221
Cam I Joint ¼" x ¼"	TWS 34222

OLDER GENERATION CAM LATCH JOINT

ITEM DESCRIPTION	Code
Cam Latch Clip-On Joint ½" x ¼"	TWS 34223

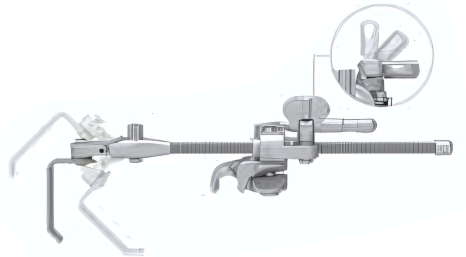
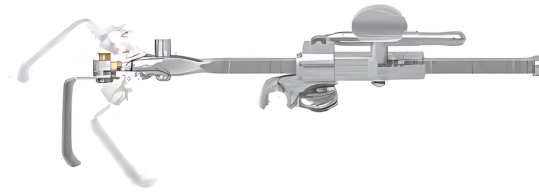

MICRO-ADJUSTABLE II HANDLES (CURRENT)

REF	ITEM DESCRIPTION	S-LOCK PART #	INTERCH. PART #
A	Clip-on Quick Angle 10"	TWS 34224	TWS 34232
	Clip-on Quick Angle 7 ¾"	TWS 34225	TWS 34233
	Clip-on Quick Angle 15"	TWS 34226	TWS 34234
	Clip-on Quick Angle 20"	TWS 34227	TWS 34235
	Clip-On 10 ¾" Bariatric		TWS 34236

MICRO-ADJUSTABLE II HANDLES (CURRENT)

REF	ITEM DESCRIPTION	S-LOCK PART #	INTERCH. PART #
B	Mini Clip-on Quick Angle 9"	TWS 34228	TWS 34237
	Clip-on 10 ¾" (non-angling)	TWS 34229	TWS 34238
	Clip-on 8 ¾" (non-angling)	TWS 34230	TWS 34239
	Slide-on Quick Angle 7 ¾"	TWS 34231	TWS 34240
	Clip-On 10 ¾" Bariatric (non-angling)		TWS 34241
	Clip-On 8 ¾" Bariatric (non-angling)		TWS 34242



OLDER GENERATION MICRO-ADJUSTABLE II HANDLES

REF	ITEM DESCRIPTION	S-LOCK PART #	INTERCH. PART #
A	Clip-On Angling 10"	TWS 34263	TWS 34243
	Clip-On Angling 7 ¾"	TWS 34264	TWS 34244
	Clip-On Angling 15"	TWS 34265	TWS 34245
	Clip-On Angling 20 ½"	TWS 34266	TWS 34246
	Clip-On 10 ¾" (non-angling)	TWS 34267	TWS 34247
	Clip-On 8 ¾" (non-angling)	TWS 34268	TWS 34248
	Slide-On Angling 10"	TWS 34269	TWS 34249
	Slide-On Angling 7 ¾"	TWS 34270	TWS 34250

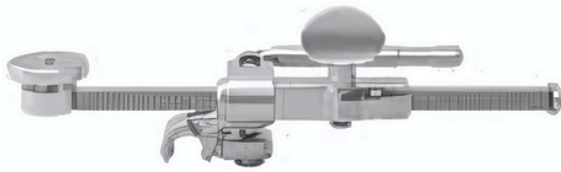

OLDER GEN. MICRO-ADJ II ROTATABLE HANDLES

REF	ITEM DESCRIPTION	Code
D	Clip-On Rotatable 10"	TWS 34272
	Latch Rotatable 10"	TWS 34273
	Slide-On Rotatable 10"	TWS 34274
	Slide-On Rotatable 10"	TWS 34275
	Clip-On Rotatable 10"	TWS 34276



CAM II CLIP-ON HANDLES (CURRENT)

REF	ITEM DESCRIPTION	S-LOCK PART #	INTERCH. PART #
E	Clip-on Quick Angle 8"	TWS 34276	TWS 34278
	Clip-on Quick Angle 10"	TWS 34277	TWS 34279



CAM II CLIP-ON DUAL ANGLE + FREE ANGLE HANDLES (CURRENT)

REF	ITEM DESCRIPTION	S-LOCK PART #	INTERCH. PART #
J	Clip-On Dual Angle 8"	TWS 34296	TWS 34283

OLDER GEN MICRO-ADJUSTABLE II HANDLES Continue

REF	ITEM DESCRIPTION	S-LOCK PART #	INTERCH. PART #
A	Mini Micro Clip-On Angling 8" (cervical use only)	TWS 34271	TWS 34251
	Clip-On 15" (non-angling)		TWS 34252
	Clip-On 10 3/4" Bariatric (non-angling)		TWS 34253
	Clip-On 8 3/4" Bariatric (non-angling)		TWS 34254
	Slide-On Angling 8"		TWS 34255
	Slide-On 8 3/4" (non-angling)		TWS 34256
	Slide-On 10 3/4" (non-angling)		TWS 34257
	10 3/4" Bariatric (non-angling)		TWS 34258
	Slide-On 10" (non-angling)		TWS 34259
	Slide-On 8 3/4" Bariatric (non-angling)		TWS 34260
	Latch Interchangeable 10"		TWS 34261
	Latch Angling 10"		TWS 34262



CAM II CLIP-ON HANDLES (CURRENT)

REF	ITEM DESCRIPTION	S-LOCK PART #	INTERCH. PART #
F	Clip-on 8" (non-angling)	TWS 34293	TWS 34280
	Clip-On 10" (non-angling)	TWS 34294	TWS 34281
	Clip-on Quick Angle 8" (3/8")	TWS 34295	TWS 34282

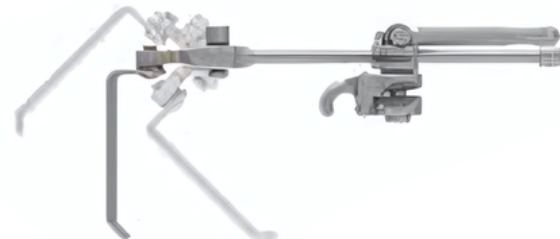

CAM II CLIP-ON DUAL ANGLE + FREE ANGLE HANDLES (CURRENT)

REF	ITEM DESCRIPTION	S-LOCK PART #	INTERCH. PART #
K	Clip-On Free Angle 8"	TWS 34297	TWS 34284

RETRACTOR HANDLES + ACCESSORIES

RETRACTOR COMPONENTS



OLDER GENERATION CAM II HANDLES

REF	ITEM DESCRIPTION	S-LOCK PART #	INTERCH. PART #
G	Clip-On Angling 8"	TWS 34298	TWS 34285
	Clip-On Angling 10"	TWS 34299	TWS 34286
	3/8" Clip-On Angling 8"	TWS 34300	TWS 34287



OLDER GENERATION CAM II HANDLES

REF	ITEM DESCRIPTION	S-LOCK PART #	INTERCH. PART #
H	Clip-On 8" (non-angling)	TWS 34301	TWS 34288
	Slide-On Angling 8"	TWS 34302	TWS 34289
	Slide-On (non-angling) 8"	TWS 34303	TWS 34290



OLDER GENERATION CAM II HANDLES

REF	ITEM DESCRIPTION	S-LOCK PART #	INTERCH. PART #
I	Cam II Angling Handle 8"	TWS 34304	TWS 34291
	Cam II Angling Handle 10"	TWS 34305	TWS 34292



CAM II CLIP-ON DUAL ANGLE + FREE ANGLE HANDLES (CURRENT)

REF	ITEM DESCRIPTION	Code
L	Hex Tool 3/16" with T-Handle	TWS 34310



OLDER GENERATION WRENCHES

REF	ITEM DESCRIPTION	Code
O	Angling Head Wrench (used with Angling Handles)	TWS 34306



OLDER GENERATION WRENCHES

REF	ITEM DESCRIPTION	Code #
p	Screw Down Wrench (used with Screw Down Joints)	TWS 34307



T-HANDLE (CURRENT)

REF	ITEM DESCRIPTION	Code
M	T-Handle (used with Quick Angle Handles)	TWS 34311



ONE-PIECE SCREW DOWN QUICK ANGLE HANDLES

REF	ITEM DESCRIPTION	S-LOCK PART #	INTERCH. PART #
N	Screw-Down Quick Angle Handle 8"	TWS 34308	TWS 34309

RETRACTOR HANDLES + ACCESSORIES

RETRACTOR COMPONENTS



UNIVERSAL JOINTS + HANDLES (CURRENT) *

REF	ITEM DESCRIPTION	S-LOCK PART #	INTERCH. PART #
A	Quick Angle Handle 8"	TWS 34316	TWS 34312
	Quick Angle Handle 10"	TWS 34317	TWS 34313



OLDER GENERATION HANDLES

REF	ITEM DESCRIPTION	S-LOCK PART #	INTERCH. PART #
E	S-Lock Angling Handle 8"	TWS 34328	
	S-Lock Angling Handle 10"	TWS 34329	
	Angling Handle 8"	TWS 34330	
	Angling Handle 10"	TWS 34331	
	S-Lock Handle 8"	TWS 34332	
	Interchangeable Blade Handle 8"	TWS 34333	
	Angling Retractor Handle	TWS 34334	
	Rotatable Handle 6"	TWS 34335	



HAND HELD ADAPTERS (CURRENT)

REF	ITEM DESCRIPTION	Code
G	Quick Angle Hand Held Adapter	TWS 34336



UNIVERSAL JOINTS + HANDLES (CURRENT) *

REF	ITEM DESCRIPTION	S-LOCK PART #	INTERCH. PART #
B	Handle 8" (non-angling)	TWS 34318	TWS 34314
	Handle 10" (non-angling)	TWS 34319	TWS 34315



UNIVERSAL JOINTS + HANDLES (CURRENT) *

REF	ITEM DESCRIPTION	S-LOCK PART #	INTERCH. PART #
C	Clip-on Joint 1/2" x 1/4"	TWS 34320	TWS 34321



UNIVERSAL JOINTS + HANDLES (CURRENT) *

REF	ITEM DESCRIPTION	S-LOCK PART #	INTERCH. PART #
D	Slide-on Joint 1/2" x 1/4"	TWS 34322	TWS 34323



UNIVERSAL JOINTS + HANDLES (CURRENT) *

REF	ITEM DESCRIPTION	S-LOCK PART #	INTERCH. PART #
F	Rotatable Handle 8"	TWS 34324	TWS 34326
	Rotatable Handle 10"	TWS 34325	TWS 34327

RETRACTOR HANDLES + ACCESSORIES

RETRACTOR COMPONENTS



HAND HELD ADAPTERS (CURRENT)

REF	ITEM DESCRIPTION	Code
H	Manipulator Handle	TWS 34337



OLDER GENERATION HAND HELD ADAPTERS

REF	ITEM DESCRIPTION	Code
I	Locking Cam Hand Held Adapter	TWS 34338



OLDER GENERATION HAND HELD ADAPTERS

REF	ITEM DESCRIPTION	Code
J	Hand Held Adapter	TWS 34339



OLDER GEN. REPLACEMENT ROTATABLE KNOB

REF	ITEM DESCRIPTION	Code
K	Replacement Knob for Rotatable Handles	TWS 34340



RATCHET RETRACTOR HANDLES (CURRENT)

REF	ITEM DESCRIPTION	S-LOCK PART #	INTERCH. PART #
M	10 ¼" (non-angling)	TWS 34341	TWS 34342



RATCHET RETRACTOR HANDLES (CURRENT)

REF	ITEM DESCRIPTION	S-LOCK PART #	INTERCH. PART #
L	Quick Angle 8"	TWS 34345	TWS 34343
	Quick Angle 10 ¼"	TWS 34346	TWS 34344

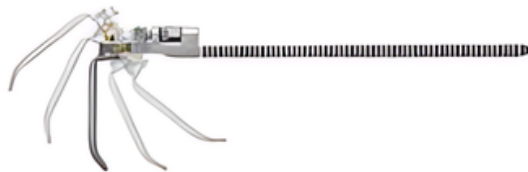

OLDER GENERATION RATCHET RETRACTOR HANDLES

REF	ITEM DESCRIPTION	S-LOCK PART #	INTERCH. PART #
N	S-Lock Angling 10 ¼"	TWS 34349	TWS 34347
	Angling 10 ¼"	TWS 34350	TWS 34348



OLDER GENERATION RATCHET RETRACTOR HANDLES

REF	ITEM DESCRIPTION	S-LOCK PART #	INTERCH. PART #
O	Rotatable	TWS 34352	TWS 34351



ADAPTER HANDLES FOR SYNFRAME®

REF	ITEM DESCRIPTION	S-LOCK PART #	INTERCH. PART #
P	Quick Angle 8 ¾"	TWS 34352	TWS 34353



ADAPTER HANDLES FOR SYNFRAME®

REF	ITEM DESCRIPTION	S-LOCK PART #	INTERCH. PART #
Q	8 ¾" (non-angling)	TWS 34354	TWS 34355

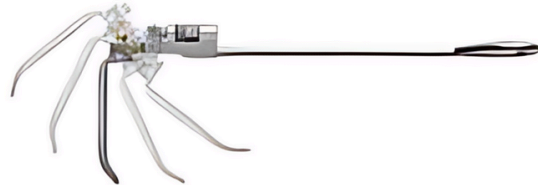

OLDER GENERATION ADAPTER

REF	ITEM DESCRIPTION	S-LOCK PART #	INTERCH. PART #
R	Angling 8 ¾"	TWS 34356	TWS 34357



ADAPTER HANDLES FOR OMNI-TRACT® (CURRENT)

REF	ITEM DESCRIPTION	S-LOCK PART #	INTERCH. PART #
S	Quick Angle 8 ¾"	TWS 34358	TWS 34360



OLDER GENERATION ADAPTER

REF	ITEM DESCRIPTION	S-LOCK PART #	INTERCH. PART #
U	S-Lock Angling 8 ¾"	TWS 34361	TWS 34364
	Angling 8 ¾"	TWS 34362	TWS 34365
	Rotatable	TWS 34363	TWS 34366



ADAPTER HANDLES FOR OMNI-TRACT® (CURRENT)

REF	ITEM DESCRIPTION	Code
T	8 ¾" (non-angling)	TWS 34367

With Lips



BALFOUR BLADES

ITEM DESCRIPTION	S-LOCK #	INTERCH. #
[with lips] 32mm x 32mm (1 ¼" x 1 ¼")	TWS 34369	TWS 34381
[with lips] 51mm x 54mm (2" x 2")	TWS 34370	TWS 34382
[with lips] 76mm x 51mm (3" x 2")	TWS 34371	TWS 34383
[with lips] 70mm x 73mm (2 ¾" x 3")	TWS 34372	TWS 34384
[with lips] 83mm x 73mm (3 ¼" x 3")	TWS 34373	TWS 34385
[with lips] 83mm x 123mm (3 ¼" x 5")	TWS 34374	TWS 34386
[with lips] 83mm x 175mm (3 ¼" x 6 7/8")	TWS 34375	TWS 34387
Radiolucent [with lips] 32mm x 32mm (1 ¼" x 1 ¼")	TWS 34376	TWS 34388
Radiolucent [with lips] 65mm x 72mm (2 ½" x 2 ¾") ANTERIOR LUMBAR USE ONLY	TWS 34377	TWS 34389
Radiolucent [with lips] 65mm x 72mm (2 ½" x 2 ¾")	TWS 34378	TWS 34390
Radiolucent [with lips] 83mm x 70mm (3 ¼" x 2 ¾") ANTERIOR LUMBAR USE ONLY	TWS 34379	TWS 34391
Radiolucent [with lips] 83mm x 127mm (3 ¼" x 5")	TWS 34380	TWS 34392
Radiolucent [with lips] 83mm x 70mm (3 ¼" x 2 ¾")	TWS 34368	



Rotatable

BALFOUR BLADES Rotatable

TYPE	ITEM DESCRIPTION	Code #
RTB	[with lips] 32mm x 32mm (1 ¼" x 1 ¼")	TWS 34415
RTB	[with lips] 51mm x 54mm (2" x 2")	TWS 34416
RTB	[with lips] 76mm x 51mm (3" x 2")	TWS 34417
RTB	[with lips] 70mm x 73mm (2 ¾" x 3")	TWS 34418
RTB	[with lips] 83mm x 73mm (3 ¼" x 3")	TWS 34419
RTB	[with lips] 83mm x 123mm (3 ¼" x 5")	TWS 34420
RTB	[with lips] 83mm x 175mm (3 ¼" x 6 7/8")	TWS 34421
RTB	[small lips] 66mm x 73mm (2 ½" x 3")	TWS 34422
RTB	[small lips] 78mm x 73mm (3" x 3")	TWS 34423

Anodized Aluminium

With Lips With Small Lips



BALFOUR BLADES

ITEM DESCRIPTION	S-LOCK #	INTERCH. #
Radiolucent [with lips] 32mm x 32mm (1 ¼" x 1 ¼") [Anodized]	TWS 34393	TWS 34398
Radiolucent [with lips] 51mm x 51mm (2" x 2") [Anodized]	TWS 34394	TWS 34399
Radiolucent [with lips] 65mm x 72mm (2 ½" x 2 ¾") [Anodized]	TWS 34395	TWS 34400
Radiolucent [small lips] 65mm x 72mm (2 ½" x 2 ¾") [Anodized]	TWS 34403	TWS 34405
Radiolucent [with lips] 83mm x 70mm (3 ¼" x 2 ¾") [Anodized]	TWS 34396	TWS 34401
Radiolucent [small lips] 83mm x 70mm (3 ¼" x 2 ¾") [Anodized]	TWS 34404	TWS 34406
Radiolucent [with lips] 83mm x 127mm (3 ¼" x 5") [Anodized]	TWS 34397	TWS 34402

With Small Lips



BALFOUR BLADES

ITEM DESCRIPTION	S-LOCK #	INTERCH. #
[small lips] 66mm x 73mm (2 ½" x 3")	TWS 34407	TWS 34411
[small lips] 78mm x 73mm (3" x 3")	TWS 34408	TWS 34412
Radiolucent [small lips] 65mm x 72mm (2 ½" x 2 ¾")	TWS 34409	TWS 34413
Radiolucent [small lips] 83mm x 70mm (3 ¼" x 2 ¾")	TWS 34410	TWS 34414

BALFOUR BLADES Rotatable CONTINUED

TYPE	ITEM DESCRIPTION	Code #
RTB	Radiolucent [with lips] 65mm x 72mm (2 ½" x 2 ¾")	TWS 34424
RTB	Radiolucent [small lips] 65mm x 72mm (2 ½" x 2 ¾")	TWS 34425
RTB	Radiolucent [with lips] 83mm x 70mm (3 ¼" x 2 ¾")	TWS 34426

Retractor blades

RETRACTOR SYSTEM BLADES



Swivel



Fixed

BALFOUR BLADES Swivel

REF	ITEM DESCRIPTION	Code #
SWL	[with lips] 32mm x 32mm (1 ¼" x 1 ¼")	TWS 34427
SWL	[with lips] 51mm x 54mm (2" x 2")	TWS 34428
SWL	[with lips] 76mm x 51mm (3" x 2")	TWS 34429
SWL	[with lips] 70mm x 73mm (2 ¾" x 3")	TWS 34430
SWL	[with lips] 83mm x 73mm (3 ¼" x 3")	TWS 34431
SWL	[with lips] 83mm x 123mm (3 ¼" x 5")	TWS 34432
SWL	[with lips] 83mm x 175mm (3 ¼" x 6 7/8")	TWS 34433
SWL	[small lips] 66mm x 73mm (2 ½" x 3")	TWS 34434
SWL	[small lips] 78mm x 73mm (3" x 3")	TWS 34435

BALFOUR BLADES Fixed

TYPE	ITEM DESCRIPTION	Code #
FXD	[with lips] 32mm x 32mm (1 ¼" x 1 ¼")	TWS 34436
FXD	[with lips] 51mm x 54mm (2" x 2")	TWS 34437
FXD	[with lips] 76mm x 51mm (3" x 2")	TWS 34438
FXD	[with lips] 70mm x 73mm (2 ¾" x 3")	TWS 34439
FXD	[with lips] 83mm x 73mm (3 ¼" x 3")	TWS 34440
FXD	[with lips] 83mm x 123mm (3 ¼" x 5")	TWS 34441
FXD	[with lips] 83mm x 175mm (3 ¼" x 6 7/8")	TWS 34442
FXD	[small lips] 66mm x 73mm (2 ½" x 3")	TWS 34443
FXD	[small lips] 78mm x 73mm (3" x 3")	TWS 34444



S Lock



Interchangeable

WIDE BALFOUR (ROCHARD) BLADES - S Lock

TYPE	ITEM DESCRIPTION	Code #
SO	83mm x 57mm (3 ¼" x 2 ¼")	TWS 34445
SO	100mm x 61mm (4" x 2 3/8")	TWS 34446
SO	114mm x 63mm (4 ½" x 2 ½")	TWS 34447
SO	Radiolucent 83mm x 57mm (3 ¼" x 2 ¼") [Anodized Aluminum]	TWS 34448
SO	Radiolucent 102mm x 57mm (4" x 2 ¼") [Anodized Aluminum]	TWS 34449
SO	Radiolucent 114mm x 57mm (4 ½" x 2 ¼") [Anodized Aluminum]	TWS 34450

WIDE BALFOUR (ROCHARD) BLADES - Interchangeable

TYPE	ITEM DESCRIPTION	Code #
INT	83mm x 57mm (3 ¼" x 2 ¼")	TWS 34451
INT	100mm x 61mm (4" x 2 3/8")	TWS 34452
INT	114mm x 63mm (4 ½" x 2 ½")	TWS 34453
INT	Radiolucent 83mm x 57mm (3 ¼" x 2 ¼") [Anodized Aluminum]	TWS 34454
INT	Radiolucent 102mm x 57mm (4" x 2 ¼") [Anodized Aluminum]	TWS 34455
INT	Radiolucent 114mm x 57mm (4 ½" x 2 ¼") [Anodized Aluminum]	TWS 34456



WIDE BALFOUR (ROCHARD) BLADES - Fixed

TYPE	ITEM DESCRIPTION	Code #
FXD	83mm x 57mm (3 ¼" x 2 ¼")	TWS 34457
FXD	100mm x 61mm (4" x 2 3/8")	TWS 34458
FXD	114mm x 63mm (4 ½" x 2 ½")	TWS 34459

NON-SLIP BALFOUR BLADES

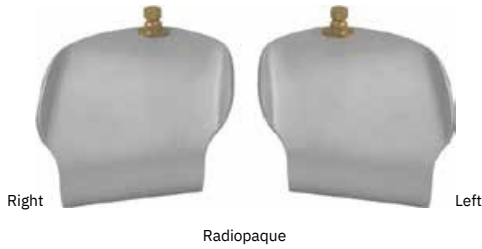

Radiopaque

BALFOUR BLADES - Right Angel

ITEM DESCRIPTION	S-LOCK #	INTERCH. #
77mm x 94mm (3" x 3 ¾")	TWS 34460	TWS 34464
77mm x 66mm (3" x 2 ½")	TWS 34461	TWS 34465
With Holes 77mm x 94mm (3" x 3 ¾")	TWS 34462	TWS 34466
With Holes 77mm x 66mm (3" x 2 ½")	TWS 34463	TWS 34467

BALFOUR BLADES - Left Angel

ITEM DESCRIPTION	S-LOCK #	INTERCH. #
77mm x 94mm (3" x 3 ¾")	TWS 34468	TWS 34472
77mm x 66mm (3" x 2 ½")	TWS 34469	TWS 34473
With Holes 77mm x 94mm (3" x 3 ¾")	TWS 34470	TWS 34474
With Holes 77mm x 66mm (3" x 2 ½")	TWS 34471	TWS 34475



Radiolucent Anodized Aluminum

BALFOUR BLADES Anodized - Right Angel

ITEM DESCRIPTION	S-LOCK #	INTERCH. #
Radiolucent 77mm x 94mm (3" x 3 ¾")	TWS 34476	TWS 34480
Radiolucent 77mm x 66mm (3" x 2 ½")	TWS 34477	TWS 34481
With Holes 77mm x 94mm (3" x 3 ¾")	TWS 34478	TWS 34482
With Holes 77mm x 66mm (3" x 2 ½")	TWS 34479	TWS 34483

BALFOUR BLADES Anodized - Left Angel

ITEM DESCRIPTION	S-LOCK #	INTERCH. #
Radiolucent 77mm x 94mm (3" x 3 ¾")	TWS 34484	TWS 34488
Radiolucent 77mm x 66mm (3" x 2 ½")	TWS 34485	TWS 34489
With Holes 77mm x 94mm (3" x 3 ¾")	TWS 34486	TWS 34490
With Holes 77mm x 66mm (3" x 2 ½")	TWS 34487	TWS 34491

Retractor Blades

RETRACTOR SYSTEM BLADES



S-Lock

Interchangeable



HARRINGTON (SWEETHEART) BLADES

TYPE	ITEM DESCRIPTION	CODES
SO	38mm x 127mm (1 1/2" x 5")	TWS 34492
SO	64mm x 102mm (2 1/2" x 4")	TWS 34493
SO	64mm x 152mm (2 1/2" x 6")	TWS 34494
SO	64mm x 203mm (2 1/2" x 8")	TWS 34495
SO	64mm x 254mm (2 1/2" x 10")	TWS 34496
SO	114mm x 254mm (4 1/2" x 10")	TWS 34497
SO	Radiolucent 64mm x 152mm (2 1/2" x 6") Titanium	TWS 34498
SO	Radiolucent 64mm x 152mm (2 1/2" x 6") Titanium	TWS 34499
SO	Radiolucent 64mm x 152mm (2 1/2" x 6") Aluminum	TWS 34500
SO	Radiolucent 64mm x 203mm (2 1/2" x 8")	TWS 34501
SO	Radiolucent 64mm x 254mm (2 1/2" x 10")	TWS 34502
SO	Radiolucent 64mm x 102mm (2 1/2" x 4")	TWS 34503

HARRINGTON (SWEETHEART) BLADES

TYPE	ITEM DESCRIPTION	CODES
INT	38mm x 127mm (1 1/2" x 5")	TWS 34504
INT	64mm x 102mm (2 1/2" x 4")	TWS 34505
INT	64mm x 152mm (2 1/2" x 6")	TWS 34506
INT	64mm x 203mm (2 1/2" x 8")	TWS 34507
INT	64mm x 254mm (2 1/2" x 10")	TWS 34508
INT	114mm x 203mm (4 1/2" x 8")	TWS 34509
INT	114mm x 254mm (4 1/2" x 10")	TWS 34510
INT	38mm x 203mm (1 1/2" x 8")	TWS 34511
INT	Radiolucent 64mm x 152mm (2 1/2" x 6") Titanium	TWS 34512
INT	Radiolucent 64mm x 152mm (2 1/2" x 6") Titanium	TWS 34513
INT	Radiolucent 64mm x 152mm (2 1/2" x 6") Aluminum	TWS 34514



Rotatable

Swivel/Fixed



HARRINGTON (SWEETHEART) BLADES

TYPE	ITEM DESCRIPTION	Code #
RTB	38mm x 127mm (1 1/2" x 5")	TWS 34515
RTB	64mm x 152mm (2 1/2" x 6")	TWS 34516
RTB	64mm x 203mm (2 1/2" x 8")	TWS 34517
RTB	64mm x 254mm (2 1/2" x 10")	TWS 34518
RTB	114mm x 254mm (4 1/2" x 10")	TWS 34519
RTB	Radiolucent 64mm x 152mm (2 1/2" x 6") Aluminum	TWS 34520

HARRINGTON (SWEETHEART) BLADES

TYPE	ITEM DESCRIPTION	Code #
SWL	38mm x 127mm (1 1/2" x 5")	TWS 34521
SWL	64mm x 152mm (2 1/2" x 6")	TWS 34522
SWL	64mm x 203mm (2 1/2" x 8")	TWS 34523
SWL	64mm x 254mm (2 1/2" x 10")	TWS 34524
SWL	114mm x 254mm (4 1/2" x 10")	TWS 34525
FXD	38mm x 127mm (1 1/2" x 5")	TWS 34526
FXD	64mm x 102mm (2 1/2" x 4")	TWS 34527
FXD	64mm x 152mm (2 1/2" x 6")	TWS 34528
FXD	64mm x 203mm (2 1/2" x 8")	TWS 34529
FXD	64mm x 254mm (2 1/2" x 10")	TWS 34530

Retractor Blades

RETRACTOR SYSTEM BLADES



Fixed



S-Lock (SO)

WEINBERG BLADES

TYPE	ITEM DESCRIPTION	Code #
FXD	102mm x 152mm (4" x 6")	TWS 34531
FXD	83mm x 133mm (3 ¼" x 5 ¼")	TWS 34532
FXD	102mm x 203mm (4" x 8")	TWS 34533



Interchangeable

KELLY BLADES - Interchangeable

TYPE	ITEM DESCRIPTION	Code #
INT	38mm x 51mm (1 ½" x 2")	TWS 34542
INT	51mm x 64mm (2" x 2 ½")	TWS 34543
INT	64mm x 76mm (2 ½" x 3")	TWS 34544
INT	76mm x 89mm (3" x 3 ½")	TWS 34545
INT	Radiolucent 38mm x 51mm (1 ½" x 2")	TWS 34546
INT	Radiolucent 51mm x 64mm (2" x 2 ½")	TWS 34547
INT	Radiolucent 64mm x 76mm (2 ½" x 3")	TWS 34548
INT	Radiolucent 76mm x 89mm (3" x 3 ½")	TWS 34549

KELLY BLADES - S-Lock (SO)

TYPE	ITEM DESCRIPTION	Code #
SO	38mm x 51mm (1 ½" x 2")	TWS 34534
SO	51mm x 64mm (2" x 2 ½")	TWS 34535
SO	64mm x 76mm (2 ½" x 3")	TWS 34536
SO	76mm x 89mm (3" x 3 ½")	TWS 34537
SO	Radiolucent 38mm x 51mm (1 ½" x 2")	TWS 34538
SO	Radiolucent 51mm x 64mm (2" x 2 ½")	TWS 34539
SO	Radiolucent 64mm x 76mm (2 ½" x 3")	TWS 34540
SO	Radiolucent 76mm x 89mm (3" x 3 ½")	TWS 34541



Rotatable

KELLY BLADES - Rotatable

TYPE	ITEM DESCRIPTION	Code #
RTB	38mm x 51mm (1 ½" x 2")	TWS 34550
RTB	51mm x 64mm (2" x 2 ½")	TWS 34551
RTB	64mm x 76mm (2 ½" x 3")	TWS 34552
RTB	76mm x 89mm (3" x 3 ½")	TWS 34553

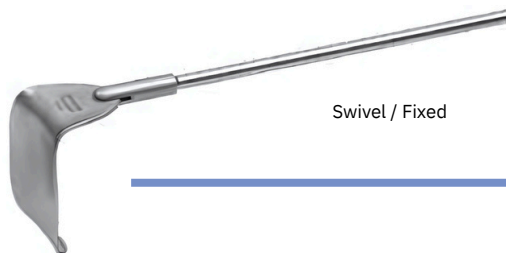

Swivel / Fixed

KELLY BLADES - Swivel / Fixed

ITEM DESCRIPTION	SWIVEL	FIXEC
38mm x 51mm (1 ½" x 2")	TWS 34554	TWS 34558
51mm x 64mm (2" x 2 ½")	TWS 34555	TWS 34559
64mm x 76mm (2 ½" x 3")	TWS 34556	TWS 34560
76mm x 89mm (3" x 3 ½")	TWS 34557	TWS 34561



S-Lock

SPLANCHNICH BLADES - S-Lock

TYPE	ITEM DESCRIPTION	Code #
SO	51mm x 114mm (2" x 4 1/2")	TWS 34562
SO	51mm x 152mm (2" x 6")	TWS 34563
SO	Radiolucent 25mm x 152mm (1" x 6")	TWS 34564
SO	Radiolucent 25mm x 203mm (1" x 8")	TWS 34565
SO	Radiolucent 51mm x 114mm (2" x 4 1/2")	TWS 34566
SO	Radiolucent 51mm x 152mm (2" x 6")	TWS 34567
SO	Radiolucent 51mm x 203mm (2" x 8")	TWS 34568



Swivel

SPLANCHNICH BLADES - Swivel

TYPE	ITEM DESCRIPTION	Code #
SWL	51mm x 114mm (2" x 4 1/2")	TWS 34576
SWL	51mm x 152mm (2" x 6")	TWS 34577
SWL	Radiolucent 51mm x 152mm (2" x 6")	TWS 34578



Rotatable

FENCE BLADES - Rotatable

TYPE	ITEM DESCRIPTION	Code #
RTB	102mm x 102mm (4" x 4")	TWS 34595
RTB	102mm x 127mm (4" x 5")	TWS 34596
RTB	102mm x 152mm (4" x 6")	TWS 34597
RTB	102mm x 203mm (4" x 8")	TWS 34598



Interchangeable

SPLANCHNICH BLADES - Interchangeable

TYPE	ITEM DESCRIPTION	Code #
INT	51mm x 114mm (2" x 4 1/2")	TWS 34569
INT	51mm x 152mm (2" x 6")	TWS 34570
INT	Radiolucent 25mm x 152mm (1" x 6")	TWS 34571
INT	Radiolucent 25mm x 203mm (1" x 8")	TWS 34572
INT	Radiolucent 51mm x 114mm (2" x 4 1/2")	TWS 34573
INT	Radiolucent 51mm x 152mm (2" x 6")	TWS 34574
INT	Radiolucent 51mm x 203mm (2" x 8")	TWS 34575



S-Lock (SO)



FENCE BLADES - S-Lock (SO) / Interchange

ITEM DESCRIPTION	S-LOCK	INTERCH
102mm x 102mm (4" x 4")	TWS 34579	TWS 34587
102mm x 127mm (4" x 5")	TWS 34580	TWS 34588
102mm x 152mm (4" x 6")	TWS 34581	TWS 34589
102mm x 203mm (4" x 8")	TWS 34582	TWS 34590
Radiolucent 102mm x 102mm (4" x 4")	TWS 34583	TWS 34591
Radiolucent 102mm x 127mm (4" x 5")	TWS 34584	TWS 34592
Radiolucent 102mm x 152mm (4" x 6")	TWS 34585	TWS 34593
Radiolucent 102mm x 203mm (4" x 8")	TWS 34586	TWS 34594



Swivel/FXD

FENCE BLADES - Swivel/FXD

ITEM DESCRIPTION	SWIVEL	FXD
102mm x 102mm (4" x 4")	TWS 34599	TWS 34602
102mm x 127mm (4" x 5")	TWS 34600	TWS 34603
102mm x 152mm (4" x 6")	TWS 34601	TWS 34604

Retractor Blades

RETRACTOR SYSTEM BLADES



S-Lock

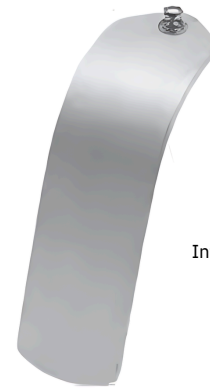

Interchange

MALLEABLE BLADES- S-Lock

TYPE	ITEM DESCRIPTION	Code #
SO	25mm x 110 mm (1" x 4 5/16")	TWS 34605
SO	13mm x 90mm (1/2" x 3 1/2")	TWS 34606
SO	13mm x 64mm (1/2" x 2 1/2")	TWS 34607
SO	13mm x 152mm (1/2" x 6")	TWS 34608
SO	13mm x 203mm (1/2" x 8")	TWS 34609
SO	25mm x 203mm (1" x 8")	TWS 34610
SO	25mm x 104mm (1" x 4")	TWS 34611
SO	25mm x 254mm (1" x 10")	TWS 34612
SO	38mm x 254mm (1 1/2" x 10")	TWS 34613
SO	25mm x 127mm (1" x 5")	TWS 34614
SO	51mm x 102mm (2" x 4")	TWS 34615
SO	51mm x 203mm (2" x 8")	TWS 34616
SO	51mm x 254mm (2" x 10")	TWS 34617
SO	38mm x 203mm (1 1/2" x 8")	TWS 34618
SO	64mm x 254mm (2 1/2" x 10")	TWS 34619
SO	76mm x 254mm (3" x 10")	TWS 34620
SO	102mm x 254mm (4" x 10")	TWS 34621
SO	Radiolucent 25mm x 110mm (1" x 4 1/2")	TWS 34622
SO	Radiolucent 13mm x 90mm (1/2" x 3 1/2")	TWS 34623
SO	Radiolucent 13mm x 64mm (1/2" x 2 1/2")	TWS 34624
SO	Radiolucent 13mm x 152mm (1/2" x 6")	TWS 34625
SO	Radiolucent 13mm x 203mm (1/2" x 8")	TWS 34626
SO	Radiolucent 25mm x 203mm (1" x 8")	TWS 34627
SO	Radiolucent 25mm x 102mm (1" x 4")	TWS 34628
SO	Radiolucent 51mm x 254mm (2" x 10")	TWS 34629

MALLEABLE BLADES- Interchangeable

TYPE	ITEM DESCRIPTION	Code #
INT	25mm x 110 mm (1" x 4 5/16")	TWS 34641
INT	13mm x 90mm (1/2" x 3 1/2")	TWS 34642
INT	13mm x 64mm (1/2" x 2 1/2")	TWS 34643
INT	13mm x 152mm (1/2" x 6")	TWS 34644
INT	13mm x 203mm (1/2" x 8")	TWS 34645
INT	25mm x 203mm (1" x 8")	TWS 34646
INT	25mm x 104mm (1" x 4")	TWS 34647
INT	25mm x 254mm (1" x 10")	TWS 34648
INT	38mm x 254mm (1 1/2" x 10")	TWS 34649
INT	25mm x 127mm (1" x 5")	TWS 34650
INT	51mm x 102mm (2" x 4")	TWS 34651
INT	51mm x 203mm (2" x 8")	TWS 34652
INT	51mm x 254mm (2" x 10")	TWS 34653
INT	38mm x 203mm (1 1/2" x 8")	TWS 34654
INT	64mm x 254mm (2 1/2" x 10")	TWS 34655
INT	76mm x 254mm (3" x 10")	TWS 34656
INT	102mm x 254mm (4" x 10")	TWS 34657
INT	Radiolucent 25mm x 110mm (1" x 4 1/2")	TWS 34658
INT	Radiolucent 13mm x 90mm (1/2" x 3 1/2")	TWS 34659
INT	Radiolucent 13mm x 64mm (1/2" x 2 1/2")	TWS 34660
INT	Radiolucent 13mm x 152mm (1/2" x 6")	TWS 34661
INT	Radiolucent 13mm x 203mm (1/2" x 8")	TWS 34662
INT	Radiolucent 25mm x 203mm (1" x 8")	TWS 34663
INT	Radiolucent 25mm x 102mm (1" x 4")	TWS 34664
INT	Radiolucent 51mm x 254mm (2" x 10")	TWS 34665

Retractor Blades

RETRACTOR SYSTEM BLADES

MALLEABLE BLADES- S-Lock Continued

TYPE	ITEM DESCRIPTION	Code #
SO	Radiolucent 51mm x 203mm (2" x 8")	TWS 34630
SO	Radiolucent 64mm x 254mm (2 ½" x 10")	TWS 34631
SO	Radiolucent 76mm x 254mm (3" x 10")	TWS 34632
SO	Radiolucent 102mm x 254mm (4" x 10")	TWS 34633
SO	38mm x 102mm (1 ½" x 4")	TWS 34634
SO	76mm x 165mm (3" x 6 ½")	TWS 34635
SO	51mm x 165mm (2" x 6 ½")	TWS 34636
SO	25mm x 152mm (1" x 6")	TWS 34637
SO	38mm x 152mm (1 ½" x 6")	TWS 34638
SO	38mm x 127mm (1 ½" x 5")	TWS 34639
SO	25mm x 76mm (1" x 3")	TWS 34640



Rotatable

MALLEABLE BLADES- Rotatable

TYPE	ITEM DESCRIPTION	Code #
RTB	13mm x 64mm (½" x 2 ½")	TWS 34677
RTB	13mm x 152mm (½" x 6")	TWS 34678
RTB	13mm x 203mm (½" x 8")	TWS 34679
RTB	25mm x 203mm (1" x 8") S	TWS 34680
RTB	25mm x 104mm (1" x 4")	TWS 34681
RTB	25mm x 254mm (1" x 10")	TWS 34682
RTB	38mm x 254mm (1 ½" x 10")	TWS 34683
RTB	25mm x 127mm (1" x 5")	TWS 34684
RTB	51mm x 102mm (2" x 4")	TWS 34685
RTB	51mm x 203mm (2" x 8")	TWS 34686
RTB	51mm x 254mm (2" x 10")	TWS 34687
RTB	38mm x 203mm (1 ½" x 8")	TWS 34688
RTB	64mm x 254mm (2 ½" x 10")	TWS 34689
RTB	76mm x 254mm (3" x 10")	TWS 34690
RTB	102mm x 254mm (4" x 10")	TWS 34691
RTB	Radiolucent 51mm x 203mm (2" x 8")	TWS 34692
RTB	38mm x 102mm (1 ½" x 4")	TWS 34693
RTB	25mm x 152mm (1" x 6")	TWS 34694

MALLEABLE BLADES- Interchangeable Continued

TYPE	ITEM DESCRIPTION	Code #
INT	Radiolucent 51mm x 203mm (2" x 8")	TWS 34666
INT	Radiolucent 64mm x 254mm (2 ½" x 10")	TWS 34667
INT	Radiolucent 76mm x 254mm (3" x 10")	TWS 34668
INT	Radiolucent 102mm x 254mm (4" x 10")	TWS 34669
INT	38mm x 102mm (1 ½" x 4")	TWS 34670
INT	76mm x 165mm (3" x 6 ½")	TWS 34671
INT	51mm x 165mm (2" x 6 ½")	TWS 34672
INT	25mm x 152mm (1" x 6")	TWS 34673
INT	38mm x 152mm (1 ½" x 6")	TWS 34674
INT	38mm x 127mm (1 ½" x 5")	TWS 34675
INT	25mm x 76mm (1" x 3")	TWS 34676



SWIVEL /Fixed

MALLEABLE BLADES- SWIVEL /Fixed

ITEM DESCRIPTION	SWIVEL	FXD
13mm x 64mm (½" x 2 ½")	TWS 34695	
13mm x 152mm (½" x 6")	TWS 34696	
13mm x 203mm (½" x 8")	TWS 34697	
25mm x 203mm (1" x 8")	TWS 34698	TWS 34709
25mm x 104mm (1" x 4")	TWS 34699	
25mm x 254mm (1" x 10")	TWS 34700	
51mm x 102mm (2" x 4")	TWS 34701	
51mm x 203mm (2" x 8")	TWS 34702	TWS 34710
51mm x 254mm (2" x 10")	TWS 34703	TWS 34711
38mm x 203mm (1 ½" x 8")	TWS 34704	
64mm x 254mm (2 ½" x 10")	TWS 34705	TWS 34712
76mm x 254mm (3" x 10")	TWS 34706	TWS 34713
102mm x 254mm (4" x 10")	TWS 34707	TWS 34714
25mm x 152mm (1" x 6")	TWS 34708	

Retractor Blades

RETRACTOR SYSTEM BLADES



S-Lock

MALLEABLE FINGER BLADES - S-Lock

TYPE	ITEM DESCRIPTION	Code #
SO	76mm (3")	TWS 34715
SO	102mm (4")	TWS 34716
SO	152mm (6")	TWS 34717
SO	203mm (8")	TWS 34718
SO	Radiolucent 152mm (6")	TWS 34719

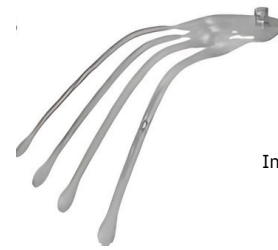

Interchange

MALLEABLE FINGER BLADES - Interchange

TYPE	ITEM DESCRIPTION	Code #
INT	76mm (3")	TWS 34720
INT	102mm (4")	TWS 34721
INT	152mm (6")	TWS 34722
INT	203mm (8")	TWS 34723
INT	Radiolucent 152mm (6")	TWS 34724

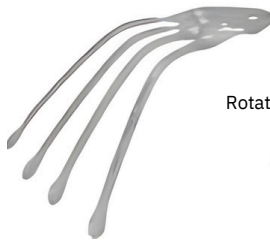

Rotatable

MALLEABLE FINGER BLADES - Rotatable

TYPE	ITEM DESCRIPTION	Code #
RTB	152mm (6")	TWS 34725

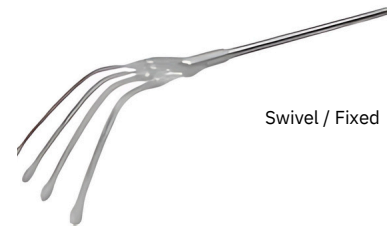

Swivel / Fixed

MALLEABLE FINGER BLADES - Swivel / Fixed

TYPE	ITEM DESCRIPTION	Code #
SWL	152mm (6")	TWS 34726
FXD	152mm (6")	



S-Lock

MALLEABLE SLOTTED BLADES - S-Lock

TYPE	ITEM DESCRIPTION	Code #
SO	51mm x 203mm (2" x 8")	TWS 34727
SO	76mm x 203mm (3" x 8")	TWS 34728
SO	51mm x 165mm (2" x 6 1/2")	TWS 34729
SO	76mm x 165mm (3" x 6 1/2")	TWS 34730



Interchange

MALLEABLE SLOTTED BLADES - Interchange

TYPE	ITEM DESCRIPTION	Code #
INT	51mm x 203mm (2" x 8")	TWS 34731
INT	76mm x 203mm (3" x 8")	TWS 34732
INT	51mm x 165mm (2" x 6 1/2")	TWS 34733
INT	76mm x 165mm (3" x 6 1/2")	TWS 34734

Retractor Blades

RETRACTOR SYSTEM BLADES

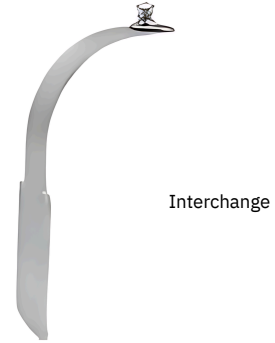

MINI-OPEN MALLEABLE BLADES S-Lock

TYPE	ITEM DESCRIPTION	Code #
SO	25mm x 75mm (1" x 3")	TWS 34735
SO	25mm x 100mm (1" x 4")	TWS 34736
SO	25mm x 125mm (1" x 5")	TWS 34737

MINI-OPEN MALLEABLE BLADES Interchange

TYPE	ITEM DESCRIPTION	Code #
INT	25mm x 75mm (1" x 3")	TWS 34738
INT	25mm x 100mm (1" x 4")	TWS 34739
INT	25mm x 125mm (1" x 5")	TWS 34740

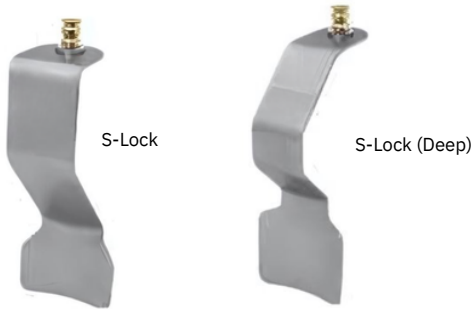

MINI-OPEN DOUBLE ANGLED BLADES

TYPE	ITEM DESCRIPTION	Code #
SO	51mm x 127mm (2" x 5")	TWS 34741
SO	51mm x 152mm (2" x 6")	TWS 34742
SO	51mm x 165mm (2" x 6 ½")	TWS 34743
SO	Deep 51mm x 127mm (2" x 5")	TWS 34744
SO(D)	51mm x 127mm (2" x 5")	TWS 34745
SO(D)	51mm x 152mm (2" x 6")	TWS 34746
SO(D)	51mm x 165mm (2" x 6 ½")	TWS 34747
SO(D)	Deep 51mm x 127mm (2" x 5")	TWS 34748

MINI-OPEN DOUBLE ANGLED BLADES -Interchange

TYPE	ITEM DESCRIPTION	Code #
INT	51mm x 127mm (2" x 5")	TWS 34749
INT	51mm x 152mm (2" x 6")	TWS 34750
INT	51mm x 165mm (2" x 6 ½")	TWS 34751
INT	Deep 51mm x 127mm (2" x 5")	TWS 34752
INT(D)	51mm x 127mm (2" x 5")	TWS 34753
INT(D)	51mm x 152mm (2" x 6")	TWS 34754
INT(D)	51mm x 165mm (2" x 6 ½")	TWS 34755
INT(D)	Deep 51mm x 127mm (2" x 5")	TWS 34756

Retractor Blades

RETRACTOR SYSTEM BLADES



S-Lock



Interchange

MINI-OPEN RICHARDSON BLADES - S-Lock

TYPE	ITEM DESCRIPTION	Code #
SO	51mm x 76mm (2" x 3")	TWS 34757
SO	51mm x 76mm (2" x 3")	TWS 34758
SO	51mm x 102mm (2" x 4")	TWS 34759
SO	51mm x 102mm (2" x 4")	TWS 34760
SO	51mm x 127mm (2" x 5")	TWS 34761
SO	51mm x 127mm (2" x 5")	TWS 34762
SO	51mm x 152mm (2" x 6")	TWS 34763
SO	51mm x 152mm (2" x 6")	TWS 34764

MINI-OPEN RICHARDSON BLADES - Interchange

TYPE	ITEM DESCRIPTION	Code #
INT	51mm x 76mm (2" x 3")	TWS 34765
INT	51mm x 102mm (2" x 4")	TWS 34766
INT	51mm x 127mm (2" x 5")	TWS 34767
INT	51mm x 152mm (2" x 6")	TWS 34768



Swivel



Rotatable

MINI-OPEN RICHARDSON BLADES - Swivel

TYPE	ITEM DESCRIPTION	Code #
SWL	51mm x 152mm (2" x 6")	TWS 34770

MINI-OPEN RICHARDSON BLADES - Rotatable

TYPE	ITEM DESCRIPTION	Code #
RTB	51mm x 76mm (2" x 3")	TWS 34769



S-Lock (SO)



RICHARDSON BLADES - S-Lock (SO)

TYPE	ITEM DESCRIPTION	Code #
SO	Radiolucent 50mm x 40mm (2" x 1 1/2")	TWS 34771
SO	Radiolucent 50mm x 60mm (2" x 2 3/8")	TWS 34772
SO	Radiolucent 50mm x 80mm (2" x 3 1/8")	TWS 34773
SO	Radiolucent 50mm x 100mm (2" x 4")	TWS 34774
SO	Radiolucent 50mm x 120mm (2" x 4 3/4")	TWS 34775
SO	Radiolucent 50mm x 140mm (2" x 5 1/2")	TWS 34776
SO	Radiolucent 50mm x 160mm (2" x 6 1/4")	TWS 34777
SO	Radiolucent 50mm x 180mm (2" x 7")	TWS 34778
SO	Radiolucent 50mm x 200mm (2" x 7 7/8")	TWS 34779
SO	Radiolucent 50mm x 210mm (2" x 8 1/4")	TWS 34780
SO	Radiolucent 50mm x 220mm (2" x 8 5/8")	TWS 34781
SO	Radiolucent 50mm x 230mm (2" x 9")	TWS 34782



Interchange

RICHARDSON BLADES - Interchange

TYPE	ITEM DESCRIPTION	Code #
INT	Radiolucent 50mm x 40mm (2" x 1 1/2")	TWS 34797
INT	Radiolucent 50mm x 60mm (2" x 2 3/8")	TWS 34798
INT	Radiolucent 50mm x 80mm (2" x 3 1/8")	TWS 34799
INT	Radiolucent 50mm x 100mm (2" x 4")	TWS 34800
INT	Radiolucent 50mm x 120mm (2" x 4 3/4")	TWS 34801
INT	Radiolucent 50mm x 140mm (2" x 5 1/2")	TWS 34802
INT	Radiolucent 50mm x 160mm (2" x 6 1/4")	TWS 34803
INT	Radiolucent 50mm x 180mm (2" x 7")	TWS 34804
INT	Radiolucent 50mm x 200mm (2" x 7 7/8")	TWS 34805
INT	Radiolucent 50mm x 210mm (2" x 8 1/4")	TWS 34806
INT	Radiolucent 50mm x 220mm (2" x 8 5/8")	TWS 34807
INT	Radiolucent 50mm x 230mm (2" x 9")	TWS 34808
INT	Radiolucent 50mm x 240mm (2" x 9 1/2")	TWS 34809
INT	Radiolucent 50mm x 250mm (2" x 9 7/8")	TWS 34810
INT	Radiolucent 51mm x 178mm (2" x 7")	TWS 34811
INT	Radiolucent 44mm x 51mm (1 3/4" x 2")	TWS 34812
INT	44mm x 51mm (1 3/4" x 2")	TWS 34813
INT	51mm x 76mm (2" x 3")	TWS 34814
INT	51mm x 102mm (2" x 4")	TWS 34815
INT	51mm x 127mm (2" x 5")	TWS 34816
INT	51mm x 152mm (2" x 6")	TWS 34817
INT	51mm x 178mm (2" x 7")	TWS 34818

RICHARDSON BLADES - S-Lock (SO) Continued

TYPE	ITEM DESCRIPTION	Code #
SO	Radiolucent 50mm x 240mm (2" x 9 1/2")	TWS 34783
SO	Radiolucent 50mm x 250mm (2" x 9 7/8")	TWS 34784
SO	Radiolucent 51mm x 76mm (2" x 3")	TWS 34785
SO	Radiolucent 51mm x 102mm (2" x 4")	TWS 34786
SO	Radiolucent 51mm x 127mm (2" x 5")	TWS 34787
SO	Radiolucent 51mm x 152mm (2" x 6")	TWS 34788
SO	Radiolucent 51mm x 178mm (2" x 7")	TWS 34789
SO	Radiolucent 44mm x 51mm (1 3/4" x 2")	TWS 34790
SO	44mm x 51mm (1 3/4" x 2")	TWS 34791
SO	51mm x 76mm (2" x 3")	TWS 34792
SO	51mm x 102mm (2" x 4")	TWS 34793
SO	51mm x 127mm (2" x 5")	TWS 34794
SO	51mm x 152mm (2" x 6")	TWS 34795
SO	51mm x 178mm (2" x 7")	TWS 34796



Rotatable

RICHARDSON BLADES - Rotatable

TYPE	ITEM DESCRIPTION	Code #
RTB	51mm x 102mm (2" x 4")	TWS 34823
RTB	51mm x 127mm (2" x 5")	TWS 34824
RTB	51mm x 152mm (2" x 6")	TWS 34825
RTB	51mm x 178mm (2" x 7")	TWS 34826

Retractor Blades

RETRACTOR SYSTEM BLADES



SWIVEL



Fixed

RICHARDSON BLADES - SWIVEL

TYPE	ITEM DESCRIPTION	Code #
SWL	51mm x 102mm (2" x 4")	TWS 34819
SWL	51mm x 127mm (2" x 5")	TWS 34820
SWL	51mm x 152mm (2" x 6")	TWS 34821
SWL	51mm x 178mm (2" x 7")	TWS 34822

RICHARDSON BLADES - Fixed

TYPE	ITEM DESCRIPTION	Code #
FXD	51mm x 102mm (2" x 4")	TWS 34827
FXD	51mm x 127mm (2" x 5")	TWS 34828
FXD	51mm x 152mm (2" x 6")	TWS 34829
FXD	51mm x 178mm (2" x 7")	TWS 34830



S-Lock



Interchangeable

MINI RICHARDSON BLADES - S-Lock

TYPE	ITEM DESCRIPTION	Code #
SO	19mm x 25mm (¾" x 1")	TWS 34831
SO	19mm x 51mm (¾" x 2")	TWS 34832
SO	25mm x 32mm (1" x 1 ¼")	TWS 34833

MINI RICHARDSON BLADES - Interchangeable

TYPE	ITEM DESCRIPTION	Code #
INT	19mm x 25mm (¾" x 1")	TWS 34834
INT	19mm x 51mm (¾" x 2")	TWS 34835
INT	25mm x 32mm (1" x 1 ¼")	TWS 34836



SWIVEL



FIXED

MINI RICHARDSON BLADES - SWIVEL

TYPE	ITEM DESCRIPTION	Code #
SWL	19mm x 25mm (¾" x 1")	TWS 34837
SWL	19mm x 51mm (¾" x 2")	TWS 34838
SWL	25mm x 32mm (1" x 1 ¼")	TWS 34839

MINI RICHARDSON BLADES - FIXED

TYPE	ITEM DESCRIPTION	Code #
FXD	19mm x 25mm (¾" x 1")	TWS 34840
FXD	19mm x 51mm (¾" x 2")	TWS 34841
FXD	25mm x 32mm (1" x 1 ¼")	TWS 34842

Retractor Blades

RETRACTOR SYSTEM BLADES



S-Lock (SO)



interchange

ST. MARKS BLADES - S-Lock (SO)

TYPE	ITEM DESCRIPTION	Code #
SO	[no lip] 64mm x 178mm (2 ½" x 7")	TWS 34843
SO	[with lip] 64mm x 178mm (2 ½" x 7")	TWS 34844
SO	[with lip] 64mm x 140mm (2 ½" x 5 ½")	TWS 34845
SO	Radiolucent [with lip] 64mm x 140mm (2 ½" x 5 ½")	TWS 34846
SO	Radiolucent [with lip] 64mm x 178mm (2 ½" x 7")	TWS 34847

ST. MARKS BLADES - interchange

TYPE	ITEM DESCRIPTION	Code #
INT	[no lip] 64mm x 178mm (2 ½" x 7")	TWS 34848
INT	[with lip] 64mm x 178mm (2 ½" x 7")	TWS 34849
INT	[with lip] 64mm x 140mm (2 ½" x 5 ½")	TWS 34850
INT	Radiolucent [with lip] 64mm x 140mm (2 ½" x 5 ½")	TWS 34851
INT	Radiolucent [with lip] 64mm x 178mm (2 ½" x 7")	TWS 34852



Rotatable



Swivel /Fixed

ST. MARKS BLADES - Rotatable

TYPE	ITEM DESCRIPTION	Code #
RTB	[no lip] 64mm x 178mm (2 ½" x 7")	TWS 34853
RTB	[with lip] 64mm x 178mm (2 ½" x 7")	TWS 34854
RTB	[with lip] 64mm x 140mm (2 ½" x 5 ½")	TWS 34855

ST. MARKS BLADES - Swivel /Fixed

TYPE	ITEM DESCRIPTION	Code #
SWL	[with lip] 64mm x 178mm (2 ½" x 7")	TWS 34856
FXD	[with lip] 64mm x 178mm (2 ½" x 7")	TWS 34857



S-Lock



Interchange

DEAVER BLADES (NON-MALLEABLE) - S-Lock

TYPE	ITEM DESCRIPTION	Code #
SO	25mm x 127mm (1" x 5")	TWS 34858
SO	38mm x 127mm (1 ½" x 5")	TWS 34859
SO	51mm x 127mm (2" x 5")	TWS 34860
SO	64mm x 127mm (2 ½" x 5")	TWS 34861
SO	76mm x 127mm (3" x 5")	TWS 34862
SO	102mm x 127mm (4" x 5")	TWS 34863

DEAVER BLADES (NON-MALLEABLE) - Interchange

TYPE	ITEM DESCRIPTION	Code #
INT	25mm x 127mm (1" x 5")	TWS 34864
INT	38mm x 127mm (1 ½" x 5")	TWS 34865
INT	51mm x 127mm (2" x 5")	TWS 34866
INT	64mm x 127mm (2 ½" x 5")	TWS 34867

Retractor Blades

RETRACTOR SYSTEM BLADES

DEAVER BLADES (NON-MALLEABLE) - S-Lock Cont

TYPE	ITEM DESCRIPTION	Code #
SO	Radiolucent 25mm x 127mm (1" x 5")	TWS 34868
SO	Radiolucent 38mm x 127mm (1 ½" x 5")	TWS 34869
SO	Radiolucent 51mm x 127mm (2" x 5")	TWS 34870
SO	Radiolucent 64mm x 127mm (2 ½" x 5")	TWS 34871
SO	Radiolucent 76mm x 127mm (3" x 5")	TWS 34872
SO	Radiolucent 76mm x 127mm (3" x 5") ANTERIOR LUMBAR USE ONLY	TWS 34873
SO	Radiolucent 102mm x 127mm (4" x 5")	TWS 34874
SO	Radiolucent 102mm x 127mm (4" x 5") ANTERIOR LUMBAR USE ONLY	TWS 34875



ROTATABLE

DEAVER BLADES (NON-MALLEABLE) - ROTATABLE

TYPE	ITEM DESCRIPTION	Code #
RTB	25mm x 127mm (1" x 5")	TWS 34884
RTB	38mm x 127mm (1 ½" x 5")	TWS 34885
RTB	51mm x 127mm (2" x 5")	TWS 34886
RTB	64mm x 127mm (2 ½" x 5")	TWS 34887
RTB	76mm x 127mm (3" x 5")	TWS 34888
RTB	51mm x 102mm (2" x 4")	TWS 34889
RTB	Radiolucent 76mm x 127mm (3" x 5")	TWS 34890



S-Lock

CONCAVE ROUND NECK RENAL BLADES

TYPE	ITEM DESCRIPTION	Code #
SO	25mm x 140mm (1" x 5 ½") Rigid	TWS 34901
SO	25mm x 191mm (1" x 7 ½") Rigid	TWS 34902

DEAVER BLADES (NON-MALLEABLE) - Interchange Cont

TYPE	ITEM DESCRIPTION	Code #
INT	Radiolucent 25mm x 127mm (1" x 5")	TWS 34876
INT	Radiolucent 38mm x 127mm (1 ½" x 5")	TWS 34877
INT	Radiolucent 51mm x 127mm (2" x 5")	TWS 34878
INT	Radiolucent 64mm x 127mm (2 ½" x 5")	TWS 34879
INT	Radiolucent 76mm x 127mm (3" x 5")	TWS 34880
INT	Radiolucent 102mm x 127mm (4" x 5")	TWS 34881
INT	76mm x 127mm (3" x 5")	TWS 34882
INT	102mm x 127mm (4" x 5")	TWS 34883



SWL/FXD

DEAVER BLADES (NON-MALLEABLE) - SWL/FXD

TYPE	ITEM DESCRIPTION	Code #
SWL	25mm x 127mm (1" x 5")	TWS 34891
SWL	38mm x 127mm (1 ½" x 5")	TWS 34892
SWL	51mm x 127mm (2" x 5")	TWS 34893
SWL	64mm x 127mm (2 ½" x 5")	TWS 34894
SWL	76mm x 127mm (3" x 5")	TWS 34895
FXD	25mm x 127mm (1" x 5")	TWS 34896
FXD	38mm x 127mm (1 ½" x 5")	TWS 34897
FXD	51mm x 127mm (2" x 5")	TWS 34898
FXD	64mm x 127mm (2 ½" x 5")	TWS 34899
FXD	76mm x 127mm (3" x 5")	TWS 34900

Retractor Blades

RETRACTOR SYSTEM BLADES



Rotatable

CONCAVE ROUND NECK RENAL BLADES Rotatable

TYPE	ITEM DESCRIPTION	Code #
RTB	25mm x 140mm (1" x 5 1/2") Rigid	TWS 34903
RTB	25mm x 191mm (1" x 7 1/2") Rigid	TWS 34904



Interchange

CONCAVE ROUND NECK RENAL BLADES

TYPE	ITEM DESCRIPTION	Code #
INT	25mm x 140mm (1" x 5 1/2") Rigid	TWS 34905
INT	25mm x 191mm (1" x 7 1/2") Rigid	TWS 34906



Fixed

CONCAVE ROUND NECK RENAL BLADES - Fixed

TYPE	ITEM DESCRIPTION	Code #
FXD	25mm x 191mm (1" x 7 1/2") Rigid	TWS 34907



S-Lock

MALLEABLE CONCAVE RENAL BLADES

TYPE	ITEM DESCRIPTION	Code #
SO	Radiolucent 25mm x 140mm (1" x 5 1/2") Malleable	TWS 34921
SO	Radiolucent 25mm x 190mm (1" x 7 1/2") Malleable	TWS 34922



Rotatable

MALLEABLE CONCAVE RENAL BLADES

TYPE	ITEM DESCRIPTION	Code #
RTB	Radiolucent 25mm x 140mm (1" x 5 1/2") Malleable	TWS 34925
RTB	Radiolucent 25mm x 190mm (1" x 7 1/2") Malleable	TWS 34926



Interchang

MALLEABLE CONCAVE RENAL BLADES

TYPE	ITEM DESCRIPTION	PART #
INT	Radiolucent 25mm x 140mm (1" x 5 1/2") Malleable	TWS 34923
INT	Radiolucent 25mm x 190mm (1" x 7 1/2") Malleable	TWS 34924



S-Lock

LONG NECK RENAL BLADES S-Lock

TYPE	ITEM DESCRIPTION	Code #
SO	Radiolucent 25mm x 203mm (1" x 8")	TWS 34916
SO	Radiolucent 25mm x 140mm (1" x 5 ½")	TWS 34917
SO	Radiolucent 25mm x 191mm (1" x 7 ½")	TWS 34918
SO	Radiolucent 25mm x 254mm (1" x 10")	TWS 34919
SO	Radiolucent 25mm x 305mm (1" x 12")	TWS 34920



Interchange

LONG NECK RENAL BLADES Interchangeable

TYPE	ITEM DESCRIPTION	Code #
INT	Radiolucent 25mm x 203mm (1" x 8")	TWS 34908
INT	Radiolucent 25mm x 140mm (1" x 5 ½")	TWS 34909
INT	Radiolucent 25mm x 191mm (1" x 7 ½")	TWS 34910
INT	Radiolucent 25mm x 254mm (1" x 10")	TWS 34911
INT	Radiolucent 25mm x 305mm (1" x 12")	TWS 34912
INT	Radiolucent 25mm x 152mm (1" x 6")	TWS 34913
INT	Radiolucent 51mm x 152mm (2" x 6")	TWS 34914
INT	Radiolucent 51mm x 203mm (2" x 8")	TWS 34915



Rotatable

LONG NECK RENAL BLADES Rotatable

TYPE	ITEM DESCRIPTION	Code #
RTB	Radiolucent 25mm x 140mm (1" x 5 ½")	TWS 34927
RTB	Radiolucent 25mm x 178mm (1" x 7")	TWS 34928
RTB	Radiolucent 25mm x 254mm (1" x 10")	TWS 34929
RTB	Radiolucent 25mm x 305mm (1" x 12")	TWS 34930
RTB	Radiolucent 25mm x 152mm (1" x 6")	TWS 34931

Retractor Blades

RETRACTOR SYSTEM BLADES

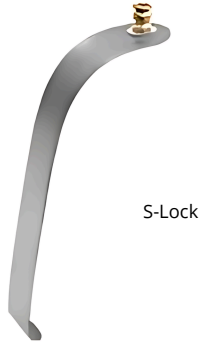

S-Lock

MALLEABLE RENAL BLADES

TYPE	ITEM DESCRIPTION	Code #
SO	25mm x 203mm (1" x 8")	TWS 34932



Interchange

MALLEABLE RENAL BLADES Interchange

TYPE	ITEM DESCRIPTION	Code #
INT	25mm x 203mm (1" x 8")	TWS 34933



Fixed

MALLEABLE RENAL BLADES - Fixed

TYPE	ITEM DESCRIPTION	Code #
FXD	25mm x 203mm (1" x 8")	TWS 34935



Rotatable

MALLEABLE RENAL BLADES Rotatable

TYPE	ITEM DESCRIPTION	Code #
RTB	25mm x 203mm (1" x 8")	TWS 34934



S-LOCK #

FENESTRATED BLADES

TYPE	ITEM DESCRIPTION	Code #
SO	44mm x 89mm (1 3/4" x 3 1/2")	TWS 34936
SO	48mm x 127mm (1 7/8" x 5")	TWS 34937

Retractor Blades

RETRACTOR SYSTEM BLADES



Interchange

FENESTRATED BLADES Interchange

TYPE	ITEM DESCRIPTION	Code #
INT	44mm x 89mm (1 ¾" x 3 ½")	TWS 34938
INT	48mm x 127mm (1 7/8" x 5")	TWS 34939



Swivel

FENESTRATED BLADES Swivel / Fixed

TYPE	ITEM DESCRIPTION	Code #
SWL	44mm x 89mm (1 ¾" x 3 ½")	TWS 34940
SWL	48mm x 127mm (1 7/8" x 5")	TWS 34941
FXD	44mm x 89mm (1 ¾" x 3 ½")	TWS 34942



S-Lock

MURPHY RAKE BLADES S-Lock

TYPE	ITEM DESCRIPTION	Code #
SO	Sharp - 3 Prong 19mm x 13mm (¾" x ½")	TWS 34943
SO	Sharp - 4 Prong 25mm x 13mm (1" x ½")	TWS 34944
SO	Blunt - 3 Prong 19mm x 13mm (¾" x ½")	TWS 34945
SO	Blunt - 4 Prong 25mm x 13mm (1" x ½")	TWS 34946



Interchange

MURPHY RAKE BLADES Interchangeable

TYPE	ITEM DESCRIPTION	Code #
INT	Sharp - 3 Prong 19mm x 13mm (¾" x ½")	TWS 34947
INT	Sharp - 4 Prong 25mm x 13mm (1" x ½")	TWS 34948
INT	Blunt - 3 Prong 19mm x 13mm (¾" x ½")	TWS 34949
INT	Blunt - 4 Prong 25mm x 13mm (1" x ½")	TWS 34950



Swivel / Fixed

MURPHY RAKE BLADES Swivel / Fixed

TYPE	ITEM DESCRIPTION	Code #
SWL	Sharp - 3 Prong 19mm x 13mm (¾" x ½")	TWS 34951
SWL	Sharp - 4 Prong 25mm x 13mm (1" x ½")	TWS 34952
SWL	Blunt - 3 Prong 19mm x 13mm (¾" x ½")	TWS 34953
SWL	Blunt - 4 Prong 25mm x 13mm (1" x ½")	TWS 34954
FXD	Sharp - 4 Prong 25mm x 13mm (1" x ½")	TWS 34955



S-Lock

VOLKMAN BLADES S-Lock

TYPE	ITEM DESCRIPTION	Code #
SO	Sharp 25mm x 13mm (1" x ½")	TWS 34956
SO	Blunt 25mm x 13mm (1" x ½")	TWS 34957
SO	Sharp 16mm x 13mm (5/8" x ½")	TWS 34958
SO	Blunt 16mm x 13mm (5/8" x ½")	TWS 34959

Retractor Blades

RETRACTOR SYSTEM BLADES



Swivel

VOLKMAN BLADES Swivel

TYPE	ITEM DESCRIPTION	Code #
SWL	Sharp 25mm x 13mm (1" x ½")	TWS 34964
SWL	Blunt 25mm x 13mm (1" x ½")	TWS 34965
SWL	Sharp 16mm x 13mm (5/8" x ½")	TWS 34966
SWL	Blunt 16mm x 13mm (5/8" x ½")	TWS 34967



Interchange

VOLKMAN BLADES Interchange

TYPE	ITEM DESCRIPTION	Code #
INT	Sharp 25mm x 13mm (1" x ½")	TWS 34960
INT	Blunt 25mm x 13mm (1" x ½")	TWS 34961
INT	Sharp 16mm x 13mm (5/8" x ½")	TWS 34962
INT	Blunt 16mm x 13mm (5/8" x ½")	TWS 34963



S-Lock

AORTIC ANUERYSM BLADES

TYPE	ITEM DESCRIPTION	Code #
SO	Large 457mm x 229mm (18" x 9")	TWS 34968
SO	Small 305mm x 216mm (12" x 8 ½")	TWS 34969



Interchange

AORTIC ANUERYSM BLADES Interchange

TYPE	ITEM DESCRIPTION	Code #
INT	Large 457mm x 229mm (18" x 9")	TWS 34970
INT	Small 305mm x 216mm (12" x 8 ½")	TWS 34971

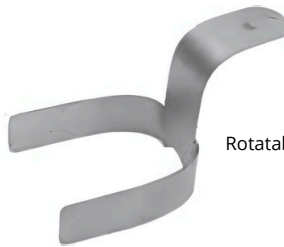

Rotatable

AORTIC ANUERYSM BLADES Rotatable

TYPE	ITEM DESCRIPTION	Code #
RTB	Large 457mm x 229mm (18" x 9")	TWS 34972
RTB	Small 305mm x 216mm (12" x 8 ½")	TWS 34973



Swivel

AORTIC ANUERYSM BLADES SWIVEL

TYPE	ITEM DESCRIPTION	Code #
SWL	Small 305mm x 216mm (12" x 8 ½")	TWS 34974

Retractor Blades

RETRACTOR SYSTEM BLADES

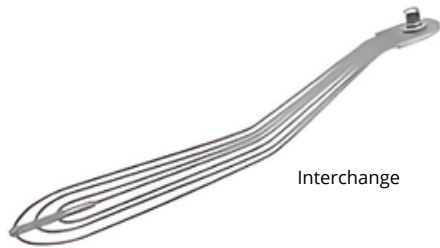

Interchange

ALLISON LUNG RETRACTORS Interchange

TYPE	ITEM DESCRIPTION	Code #
INT	229mm (9")	TWS 34975



S-Lock

ALLISON LUNG RETRACTORS S-Lock

TYPE	ITEM DESCRIPTION	Code #
SO	229mm (9")	TWS 34976



S-Lock

DOUBLE ANGLED BLADES S-Lock

TYPE	ITEM DESCRIPTION	Code #
SO	13mm x 70mm (½" x 2 ¾")	TWS 34978
SO	13mm x 76mm (½" x 3")	TWS 34979
SO	25mm x 64mm (1" x 2 ½")	TWS 34980
SO	25mm x 76mm (1" x 3")	TWS 34981

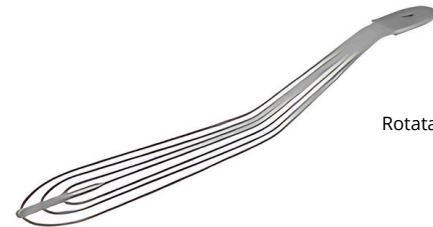

Rotatable

ALLISON LUNG RETRACTORS Rotatable

TYPE	ITEM DESCRIPTION	Code #
RTB	229mm (9")	TWS 34977



Interchange



Swivel

DOUBLE ANGLED BLADES Swivel

TYPE	ITEM DESCRIPTION	Code #
SWL	13mm x 64mm (½" x 2 ½")	TWS 34986
SWL	13mm x 76mm (½" x 3")	TWS 34987
SWL	25mm x 64mm (1" x 2 ½")	TWS 34988
SWL	25mm x 76mm (1" x 3")	TWS 34989

DOUBLE ANGLED BLADES Interchange

TYPE	ITEM DESCRIPTION	Code #
INT	13mm x 70mm (½" x 2 ¾")	TWS 34982
INT	13mm x 76mm (½" x 3")	TWS 34983
INT	25mm x 64mm (1" x 2 ½")	TWS 34984
INT	25mm x 76mm (1" x 3")	TWS 34985

Retractor Blades

RETRACTOR SYSTEM BLADES



Interchange

DOUBLE ANGLED BULB BLADES Interchange

TYPE	ITEM DESCRIPTION	Code #
INT	25mm x 64mm (1" x 2 1/2")	TWS 34990



S-Lock

DOUBLE ANGLED BULB BLADES S-Lock

TYPE	ITEM DESCRIPTION	Code #
SO	25mm x 64mm (1" x 2 1/2")	TWS 34991



Interchange

HEANY BLADES Interchange

TYPE	ITEM DESCRIPTION	Code
	25mm x 102mm (1" x 4")	TWS 34992
	25mm x 127mm (1" x 5")	TWS 34993



S-Lock

HEANY BLADES S-Lock

TYPE	ITEM DESCRIPTION	Code
SO	25mm x 102mm (1" x 4")	TWS 34994
SO	25mm x 127mm (1" x 5")	TWS 34995



Swivel / Fixed

HEANY BLADES Swivel / Fixed

TYPE	ITEM DESCRIPTION	Code
SWL	25mm x 127mm (1" x 5")	TWS 34998
FXD	25mm x 127mm (1" x 5")	TWS 34999



Rotatable

HEANY BLADES Rotatable

TYPE	ITEM DESCRIPTION	Code
RTB	25mm x 102mm (1" x 4")	TWS 34996
RTB	25mm x 127mm (1" x 5")	TWS 34997

Retractor Blades

RETRACTOR SYSTEM BLADES



Interchange

DOUBLE BLADED BLADES Interchange

TYPE	ITEM DESCRIPTION	Code
INT	76mm x 114mm (3" x 4 1/2")	TWS 35001



S-Lock

DOUBLE BLADED BLADES S-Lock

TYPE	ITEM DESCRIPTION	Code
SO	76mm x 114mm (3" x 4 1/2")	TWS 35000

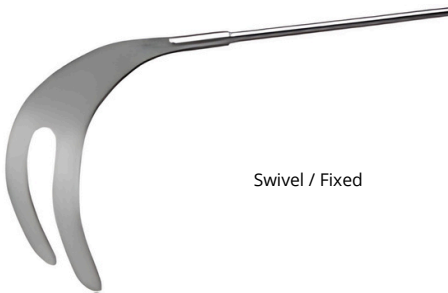

Swivel / Fixed

DOUBLE BLADED BLADES Swivel / Fixed

TYPE	ITEM DESCRIPTION	Code
SWL	76mm x 114mm (3" x 4 1/2")	TWS 35003
FXD	76mm x 114mm (3" x 4 1/2")	TWS 35004



Rotatable

DOUBLE BLADED BLADES Rotatable

TYPE	ITEM DESCRIPTION	Code
RTB	76mm x 114mm (3" x 4 1/2")	TWS 35002



Interchange

HOLTGREWE BLADES Interchange

TYPE	ITEM DESCRIPTION	Code
INT	60mm x 152mm (2 3/8" x 6") Malleable	TWS 35006



S-Lock

HOLTGREWE BLADES S-Lock

TYPE	ITEM DESCRIPTION	Code
SO	60mm x 152mm (2 3/8" x 6") Malleable	TWS 35005



Rotatable

HOLTGREWE BLADES Rotatable

TYPE	ITEM DESCRIPTION	Code
RTB	60mm x 152mm (2 3/8" x 6") Malleable	TWS 35007

Retractor Blades

RETRACTOR SYSTEM BLADES



S-Lock

"Y" BLADDER BLADES S-Lock

TYPE	ITEM DESCRIPTION	Code
SO	81mm x 216mm (3 1/8" x 8 1/2")	TWS 35009



Swivel

HOLTGREWE BLADES Swivel

TYPE	ITEM DESCRIPTION	Code
SWL	60mm x 152mm (2 3/8" x 6") Malleable	TWS 35008

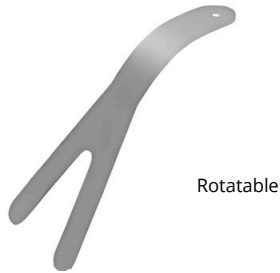

Rotatable

"Y" BLADDER BLADES Rotatable

TYPE	ITEM DESCRIPTION	Code
RTB	81mm x 216mm (3 1/8" x 8 1/2")	TWS 35010

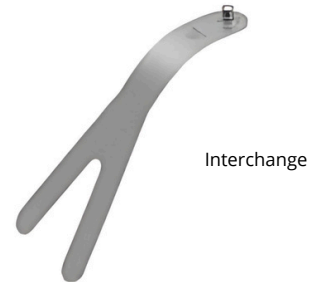

Interchange

"Y" BLADDER BLADES Interchange

TYPE	ITEM DESCRIPTION	Code
INT	81mm x 216mm (3 1/8" x 8 1/2")	TWS 35011



Swivel / Fixed

"Y" BLADDER BLADES Swivel / Fixed

TYPE	ITEM DESCRIPTION	Code
SWL	81mm x 216mm (3 1/8" x 8 1/2")	TWS 35012
FXD	81mm x 216mm (3 1/8" x 8 1/2")	TWS 35013



S-Lock

BLADDER BLADES S-Lock

TYPE	ITEM DESCRIPTION	Code
SO	35mm x 89mm (1 3/8" x 3 1/2")	TWS 35014

BLADDER BLADES Interchange

TYPE	ITEM DESCRIPTION	Code
INT	35mm x 89mm (1 3/8" x 3 1/2")	TWS 35015

Interchange



Retractor Blades

RETRACTOR SYSTEM BLADES



S-Lock

HARRIS PROSTATE RETRACTORS S-Lock

TYPE	ITEM DESCRIPTION	Code
SO	8mm (3/8")	TWS 35017



Swivel

BLADDER BLADES Swivel

TYPE	ITEM DESCRIPTION	Code
SWL	35mm x 89mm (1 3/8" x 3 1/2")	TWS 35016

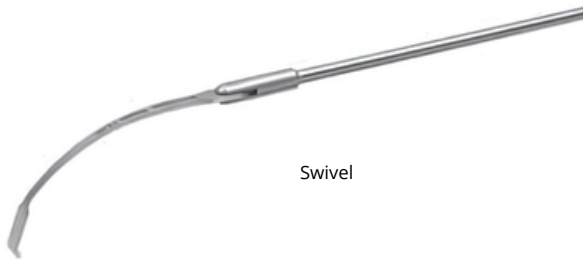

Swivel

HARRIS PROSTATE RETRACTORS Swivel

TYPE	ITEM DESCRIPTION	Code
SWL	8mm (3/8")	TWS 35019

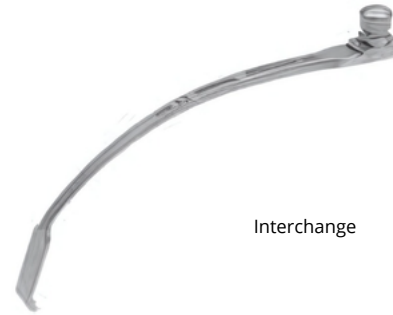

Interchange

HARRIS PROSTATE RETRACTORS Interchange

TYPE	ITEM DESCRIPTION	Code
INT	8mm (3/8")	TWS 35018



S-Lock

HILL-FERGUSON RECTAL BLADES S-Lock

TYPE	ITEM DESCRIPTION	Code
SO	32mm x 76mm (1 1/4" x 3")	TWS 35020
SO	25mm x 64mm (1" x 2 1/2")	TWS 35021



Interchange

MALLEABLE PROSTATE BLADE Interchangeable

TYPE	ITEM DESCRIPTION	Code
INT	280mm x 40mm (11" x 1 1/2")	TWS 35022

Retractor Blades

RETRACTOR SYSTEM BLADES



HILL-FERGUSON RECTAL BLADES

TYPE	ITEM DESCRIPTION	Code
INT	32mm x 76mm (1 ¼" x 3")	TWS 35023
INT	25mm x 64mm (1" x 2 ½")	TWS 35024



HILL-FERGUSON RECTAL BLADES SWIVEL

TYPE	ITEM DESCRIPTION	Code
SWL	32mm x 76mm (1 ¼" x 3")	TWS 35025
SWL	25mm x 64mm (1" x 2 ½")	TWS 35026



RECTAL BLADES

TYPE	ITEM DESCRIPTION	Code
SO	13mm x 117mm (½" x 4 ½")	TWS 35027

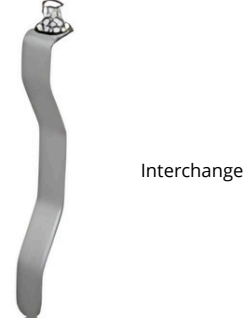
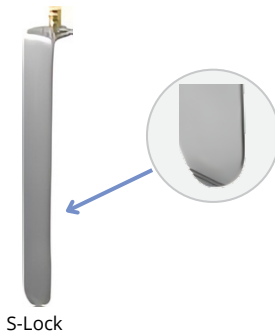

RECTAL BLADES Interchange

TYPE	ITEM DESCRIPTION	Code
INT	13mm x 117mm (½" x 4 ½")	TWS 35028

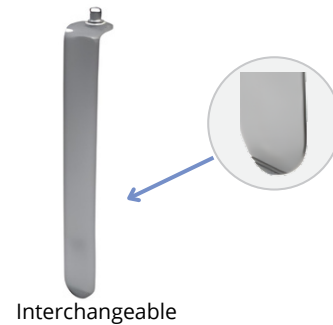

BRAU REVERSE LIP BLADES

TYPE	ITEM DESCRIPTION	Code
SO	Radiolucent Rigid 25mm x 80mm	TWS 35029
SO	Radiolucent Rigid 25mm x 90mm (1" x 3 ½")	TWS 35030
SO	Radiolucent Rigid 25mm x 100mm (1" x 4")	TWS 35031
SO	Radiolucent Rigid 25mm x 110mm (1" x 4 3/8")	TWS 35032
SO	Radiolucent Rigid 25mm x 120mm (1" x 4 ¾")	TWS 35033

BRAU REVERSE LIP BLADES Interchangeable

TYPE	ITEM DESCRIPTION	Code
INT	Radiolucent Rigid 25mm x 100mm (1" x 4")	TWS 35063
INT	Radiolucent Rigid 25mm x 110mm (1" x 4 3/8")	TWS 35064
INT	Radiolucent Rigid 25mm x 120mm (1" x 4 ¾")	TWS 35065



BRAU REVERSE LIP BLADES Continued

TYPE	ITEM DESCRIPTION	Code
SO	Radiolucent Rigid 25mm x 130mm (1" x 5 1/8")	TWS 35034
SO	Radiolucent Rigid 25mm x 140mm (1" x 5 1/2")	TWS 35035
SO	Radiolucent Rigid 25mm x 150mm (1" x 5 7/8")	TWS 35036
SO	Radiolucent Rigid 25mm x 160mm (1" x 6 1/4")	TWS 35037
SO	Radiolucent Rigid 25mm x 170mm (1" x 6 5/8")	TWS 35038
SO	Radiolucent Rigid 25mm x 180mm (1" x 7")	TWS 35039
SO	Radiolucent Rigid 25mm x 190mm (1" x 7 1/2")	TWS 35040
SO	Radiolucent Rigid 25mm x 200mm (1" x 7 7/8")	TWS 35041
SO	Radiolucent Rigid 25mm x 210mm (1" x 8 1/4")	TWS 35042
SO	Radiolucent Rigid 25mm x 220mm (1" x 8 5/8")	TWS 35043
SO	Radiolucent Rigid 25mm x 230mm (1" x 9")	TWS 35044
SO	Radiolucent Rigid 25mm x 240mm (1" x 9 1/2")	TWS 35045
SO	Radiolucent Rigid 25mm x 250mm (1" x 9 7/8")	TWS 35046
SO	Radiolucent Rigid 32mm x 100mm (1 1/4" x 4")	TWS 35047
SO	Radiolucent Rigid 32mm x 110mm (1 1/4" x 4 3/8")	TWS 35048
SO	Radiolucent Rigid 32mm x 120mm (1 1/4" x 4 3/4")	TWS 35049
SO	Radiolucent Rigid 32mm x 130mm (1 1/4" x 5 1/8")	TWS 35050
SO	Radiolucent Rigid 32mm x 140mm (1 1/4" x 5 1/2")	TWS 35051
SO	Radiolucent Rigid 32mm x 150mm (1 1/4" x 5 7/8")	TWS 35052
SO	Radiolucent Rigid 32mm x 160mm (1 1/4" x 6 1/4")	TWS 35053
SO	Radiolucent Rigid 32mm x 170mm (1 1/4" x 6 5/8")	TWS 35054
SO	Radiolucent Rigid 32mm x 180mm (1 1/4" x 7")	TWS 35055
SO	Radiolucent Rigid 32mm x 190mm (1 1/4" x 7 1/2")	TWS 35056
SO	Radiolucent Rigid 32mm x 200mm (1 1/4" x 7 7/8")	TWS 35057
SO	Radiolucent Rigid 32mm x 210mm (1 1/4" x 8 1/4")	TWS 35058
SO	Radiolucent Rigid 32mm x 220mm (1 1/4" x 8 5/8")	TWS 35059
SO	Radiolucent Rigid 32mm x 230mm (1 1/4" x 9")	TWS 35060
SO	Radiolucent Rigid 32mm x 240mm (1 1/4" x 9 1/2")	TWS 35061
SO	Radiolucent Rigid 32mm x 250mm (1 1/4" x 9 7/8")	TWS 35062

BRAU REVERSE LIP BLADES Continued

TYPE	ITEM DESCRIPTION	Code
INT	Radiolucent Rigid 25mm x 130mm (1" x 5 1/8")	TWS 35066
INT	Radiolucent Rigid 25mm x 140mm (1" x 5 1/2")	TWS 35067
INT	Radiolucent Rigid 25mm x 150mm (1" x 5 7/8")	TWS 35068
INT	Radiolucent Rigid 25mm x 160mm (1" x 6 1/4")	TWS 35069
INT	Radiolucent Rigid 25mm x 170mm (1" x 6 5/8")	TWS 35070
INT	Radiolucent Rigid 25mm x 180mm (1" x 7")	TWS 35071
INT	Radiolucent Rigid 25mm x 190mm (1" x 7 1/2")	TWS 35072
INT	Radiolucent Rigid 25mm x 200mm (1" x 7 7/8")	TWS 35073
INT	Radiolucent Rigid 25mm x 210mm (1" x 8 1/4")	TWS 35074
INT	Radiolucent Rigid 25mm x 220mm (1" x 8 5/8")	TWS 35075
INT	Radiolucent Rigid 25mm x 230mm (1" x 9")	TWS 35076
INT	Radiolucent Rigid 25mm x 240mm (1" x 9 1/2")	TWS 35077
INT	Radiolucent Rigid 25mm x 250mm (1" x 9 7/8")	TWS 35078
INT	Radiolucent Rigid 32mm x 100mm (1 1/4" x 4")	TWS 35079
INT	Radiolucent Rigid 32mm x 110mm (1 1/4" x 4 3/8")	TWS 35080
INT	Radiolucent Rigid 32mm x 120mm (1 1/4" x 4 3/4")	TWS 35081
INT	Radiolucent Rigid 32mm x 130mm (1 1/4" x 5 1/8")	TWS 35082
INT	Radiolucent Rigid 32mm x 140mm (1 1/4" x 5 1/2")	TWS 35083
INT	Radiolucent Rigid 32mm x 150mm (1 1/4" x 5 7/8")	TWS 35084
INT	Radiolucent Rigid 32mm x 160mm (1 1/4" x 6 1/4")	TWS 35085
INT	Radiolucent Rigid 32mm x 170mm (1 1/4" x 6 5/8")	TWS 35086
INT	Radiolucent Rigid 32mm x 180mm (1 1/4" x 7")	TWS 35087
INT	Radiolucent Rigid 32mm x 190mm (1 1/4" x 7 1/2")	TWS 35088
INT	Radiolucent Rigid 32mm x 200mm (1 1/4" x 7 7/8")	TWS 35089
INT	Radiolucent Rigid 32mm x 210mm (1 1/4" x 8 1/4")	TWS 35090
INT	Radiolucent Rigid 32mm x 220mm (1 1/4" x 8 5/8")	TWS 35091
INT	Radiolucent Rigid 32mm x 230mm (1 1/4" x 9")	TWS 35092
INT	Radiolucent Rigid 32mm x 240mm (1 1/4" x 9 1/2")	TWS 35093
INT	Radiolucent Rigid 32mm x 250mm (1 1/4" x 9 7/8")	TWS 35094

Retractor Blades

RETRACTOR SYSTEM BLADES

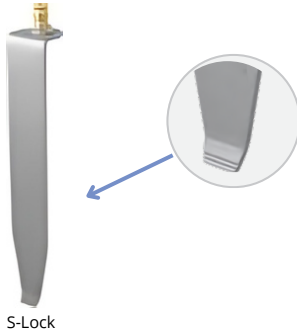

S-Lock

BRAU REVERSE LIP TAPERED BLADES

TYPE	ITEM DESCRIPTION	Code
SO	Radiolucent Tapered 25mm x 100mm (1" x 4")	TWS 35095
SO	Radiolucent Tapered 25mm x 150mm (1" x 5 7/8")	TWS 35096
SO	Radiolucent Tapered 25mm x 200mm (1" x 7 7/8")	TWS 35097
SO	Radiolucent Tapered 25mm x 250mm (1" x 9 7/8")	TWS 35098

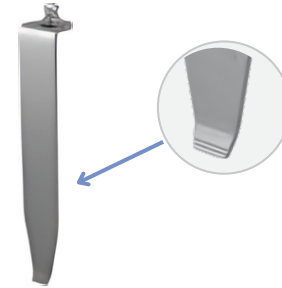

Interchangeable

BRAU REVERSE LIP TAPERED BLADES

TYPE	ITEM DESCRIPTION	Code
INT	Radiolucent Tapered 25mm x 100mm (1" x 4")	TWS 35099
INT	Radiolucent Tapered 25mm x 150mm (1" x 5 7/8")	TWS 35100
INT	Radiolucent Tapered 25mm x 200mm (1" x 7 7/8")	TWS 35101
INT	Radiolucent Tapered 25mm x 250mm (1" x 9 7/8")	TWS 35102

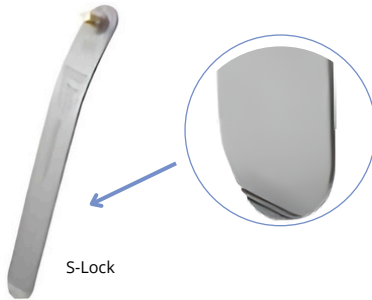

S-Lock

BRAU REVERSE LIP MALLEABLE BLADES

TYPE	ITEM DESCRIPTION	Code
SO	Radiolucent Malleable 25mm x 200mm (1" x 7 7/8")	TWS 35103
SO	Radiolucent Malleable 32mm x 200mm (1 1/4" x 7 7/8")	TWS 35104

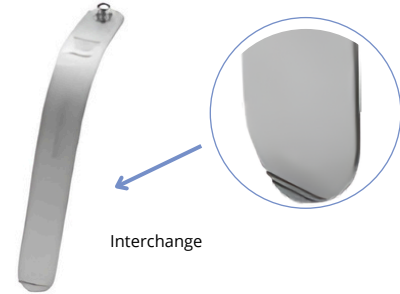

Interchange

BRAU REVERSE LIP MALLEABLE BLADES Interchange

TYPE	ITEM DESCRIPTION	Code
INT	Radiolucent Malleable 25mm x 200mm (1" x 7 7/8")	TWS 35105
INT	Radiolucent Malleable 32mm x 200mm (1 1/4" x 7 7/8")	TWS 35106

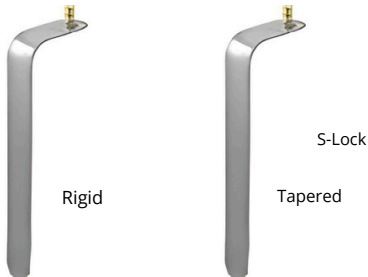

Rigid

Tapered

S-Lock

BRAU REVERSE LIP BLADES (LONG NECK) S-Lock

TYPE	ITEM DESCRIPTION	Code
SO	Radiolucent Rigid 25mm x 100mm (1" x 4")	TWS 35107
SO	Radiolucent Rigid 25mm x 150mm (1" x 5 7/8")	TWS 35108
SO	Radiolucent Rigid 25mm x 200mm (1" x 7 7/8")	TWS 35109
SO	Radiolucent Rigid 32mm x 100mm (1 1/4" x 4")	TWS 35110



Rigid

Tapered

Interchange

BRAU REVERSE LIP BLADES (LONG NECK) Interchange

TYPE	ITEM DESCRIPTION	Code
INT	Radiolucent Rigid 25mm x 100mm (1" x 4")	TWS 35111
INT	Radiolucent Rigid 25mm x 150mm (1" x 5 7/8")	TWS 35112
INT	Radiolucent Rigid 25mm x 200mm (1" x 7 7/8")	TWS 35113
INT	Radiolucent Rigid 32mm x 100mm (1 1/4" x 4")	TWS 35114

BRAU REVERSE LIP BLADES (LONG NECK) Cont

TYPE	ITEM DESCRIPTION	Code
	Radiolucent Rigid 32mm x 150mm (1 ¼" x 5 7/8")	TWS 35115
	Radiolucent Rigid 32mm x 200mm (1 ¼" x 7 7/8")	TWS 35116
	Radiolucent Rigid 25mm x 255mm (1" x 10")	TWS 35117
	Radiolucent Rigid 32mm x 255mm (1 ¼" x 10")	TWS 35118
	Radiolucent Tapered 25mm x 150mm (1" x 5 7/8")	TWS 35119
	Radiolucent Tapered 25mm x 200mm (1" x 7 7/8")	TWS 35120
	Radiolucent Rigid 25mmx100mm(1"x 4")(flat blade)	TWS 35121
	Radiolucent Rigid 25mmx150mm(1"x 5 7/8")(flat blade)	TWS 35122
	Radiolucent Rigid 25mmx200mm(1"x7 7/8")(flat blade)	TWS 35123
	Radiolucent Rigid 32mmx100mm(1¼"x4")(flat blade)	TWS 35124
	Radiolucent Rigid 32mmx150mm(1¼"x5 7/8")(flat blade)	TWS 35125
	Radiolucent Rigid 32mmx200mm(1¼"x 7 7/8")(flat blade)	TWS 35126
	Radiolucent Rigid 25mmx255mm(1"x 10")(flat blade)	TWS 35127
	Radiolucent Rigid 32mm x 255mm(1¼"x 10")(flat blade)	TWS 35128
	Radiolucent Rigid Concave 25mm x 200mm (1" x 7 7/8")	TWS 35129
	Radiolucent Rigid Concave 32mm x 200mm (1 ¼" x 7 7/8")	TWS 35130
	Radiolucent Rigid Concave 25mm x 255mm (1" x 10")	TWS 35131
	Radiolucent Rigid Concave 32mm x 255mm (1 ¼" x 10")	TWS 35132

BRAU REVERSE LIP BLADES (LONG NECK) Cont

TYPE	ITEM DESCRIPTION	Code
	Radiolucent Rigid 32mm x 150mm (1 ¼" x 5 7/8")	TWS 35133
	Radiolucent Rigid 32mm x 200mm (1 ¼" x 7 7/8")	TWS 35134
	Radiolucent Rigid 25mm x 255mm (1" x 10")	TWS 35135
	Radiolucent Rigid 32mm x 255mm (1 ¼" x 10")	TWS 35136
	Radiolucent Tapered 25mm x 150mm (1" x 5 7/8")	TWS 35137
	Radiolucent Tapered 25mm x 200mm (1" x 7 7/8")	TWS 35138
	Radiolucent Rigid 25mmx100mm(1"x4")(flat blade)	TWS 35139
	Radiolucent Rigid 25mmx150mm(1"x 5 7/8")(flat blade)	TWS 35140
	Radiolucent Rigid 25mm x200mm(1"x7 7/8")(flat blade)	TWS 35141
	Radiolucent Rigid 32mmx100mm(1¼" x 4")(flat blade)	TWS 35142
	Radiolucent Rigid 32mmx150mm(1 ¼"x5 7/8")(flat blade)	TWS 35143
	Radiolucent Rigid 32mmx200mm(1¼" x 7 7/8")(flat blade)	TWS 35144
	Radiolucent Rigid 25mmx255mm(1" x 10")(flat blade)	TWS 35145
	Radiolucent Rigid 32mmx255mm(1¼"x10")(flat blade)	TWS 35146
	Radiolucent Rigid Concave 25mm x 200mm (1" x 7 7/8")	TWS 35147
	Radiolucent Rigid Concave 32mmx200mm(1¼" x 77/8")	TWS 35148
	Radiolucent Rigid Concave 25mm x 255mm (1" x 10")	TWS 35149
	Radiolucent Rigid Concave 32mm x 255mm (1 ¼" x 10")	TWS 35150



S-Lock



Interchange

CONCAVE SHORT NECK RENAL BLADES

TYPE	ITEM DESCRIPTION	Code
SO	Radiolucent 25mm x 80mm (1" x 3 1/8")	TWS 35151
SO	Radiolucent 25mm x 90mm (1" x 3 ½")	TWS 35152
SO	Radiolucent 25mm x 100mm (1" x 4")	TWS 35153
SO	Radiolucent 25mm x 110mm (1" x 4 3/8")	TWS 35154
SO	Radiolucent 25mm x 120mm (1" x 4 ¾")	TWS 35155
SO	Radiolucent 25mm x 130mm (1" x 5 1/8")	TWS 35156
SO	Radiolucent 25mm x 140mm (1" x 5 ½")	TWS 35157
SO	Radiolucent 25mm x 150mm (1" x 5 7/8")	TWS 35158
SO	Radiolucent 25mm x 160mm (1" x 6 ¼")	TWS 35159

CONCAVE SHORT NECK RENAL BLADES INTECH

TYPE	ITEM DESCRIPTION	Code
INT	Radiolucent 25mm x 80mm (1" x 3 1/8")	TWS 35160
INT	Radiolucent 25mm x 90mm (1" x 3 ½")	TWS 35161
INT	Radiolucent 25mm x 100mm (1" x 4")	TWS 35162
INT	Radiolucent 25mm x 110mm (1" x 4 3/8")	TWS 35163
INT	Radiolucent 25mm x 120mm (1" x 4 ¾")	TWS 35164
INT	Radiolucent 25mm x 130mm (1" x 5 1/8")	TWS 35165
INT	Radiolucent 25mm x 140mm (1" x 5 ½")	TWS 35166
INT	Radiolucent 25mm x 150mm (1" x 5 7/8")	TWS 35167
INT	Radiolucent 25mm x 160mm (1" x 6 ¼")	TWS 35168

CONCAVE SHORT NECK RENAL BLADES Cont

TYPE	ITEM DESCRIPTION	Code
SO	Radiolucent 25mm x 170mm (1" x 6 5/8")	TWS 35169
SO	Radiolucent 25mm x 180mm (1" x 7")	TWS 35170
SO	Radiolucent 25mm x 190mm (1" x 7 1/2")	TWS 35171
SO	Radiolucent 25mm x 200mm (1" x 7 7/8")	TWS 35172
SO	Radiolucent 25mm x 210mm (1" x 8 1/4")	TWS 35173
SO	Radiolucent 25mm x 220mm (1" x 8 5/8")	TWS 35174
SO	Radiolucent 25mm x 230mm (1" x 9")	TWS 35175
SO	Radiolucent 25mm x 240mm (1" x 9 1/2")	TWS 35176
SO	Radiolucent 25mm x 250mm (1" x 9 7/8")	TWS 35177



S-Lock

CONCAVE SHORT NECK RENAL BLADES Cont

TYPE	ITEM DESCRIPTION	Code
INT	Radiolucent 25mm x 170mm (1" x 6 5/8")	TWS 35178
INT	Radiolucent 25mm x 180mm (1" x 7")	TWS 35179
INT	Radiolucent 25mm x 190mm (1" x 7 1/2")	TWS 35180
INT	Radiolucent 25mm x 200mm (1" x 7 7/8")	TWS 35181
INT	Radiolucent 25mm x 210mm (1" x 8 1/4")	TWS 35182
INT	Radiolucent 25mm x 220mm (1" x 8 5/8")	TWS 35183
INT	Radiolucent 25mm x 230mm (1" x 9")	TWS 35184
INT	Radiolucent 25mm x 240mm (1" x 9 1/2")	TWS 35185
INT	Radiolucent 25mm x 250mm (1" x 9 7/8")	TWS 35186



Interchange

CONCAVE SHORT NECK RENAL BLADES

TYPE	ITEM DESCRIPTION	Code
SO	Radiolucent 25mm x 80mm (1" x 3 1/8")	TWS 35187
SO	Radiolucent 25mm x 90mm (1" x 3 1/2")	TWS 35188
SO	Radiolucent 25mm x 100mm (1" x 4")	TWS 35189
SO	Radiolucent 25mm x 110mm (1" x 4 3/8")	TWS 35190
SO	Radiolucent 25mm x 120mm (1" x 4 3/4")	TWS 35191
SO	Radiolucent 25mm x 130mm (1" x 5 1/8")	TWS 35192
SO	Radiolucent 25mm x 140mm (1" x 5 1/2")	TWS 35193
SO	Radiolucent 25mm x 150mm (1" x 5 7/8")	TWS 35194
SO	Radiolucent 25mm x 160mm (1" x 6 1/4")	TWS 35195
SO	Radiolucent 25mm x 170mm (1" x 6 5/8")	TWS 35196
SO	Radiolucent 25mm x 180mm (1" x 7")	TWS 35197
SO	Radiolucent 25mm x 190mm (1" x 7 1/2")	TWS 35198
SO	Radiolucent 25mm x 200mm (1" x 7 7/8")	TWS 35199

CONCAVE SHORT NECK RENAL BLADES

TYPE	ITEM DESCRIPTION	Code
INT	Radiolucent 25mm x 80mm (1" x 3 1/8")	TWS 35200
INT	Radiolucent 25mm x 90mm (1" x 3 1/2")	TWS 35201
INT	Radiolucent 25mm x 100mm (1" x 4")	TWS 35202
INT	Radiolucent 25mm x 110mm (1" x 4 3/8")	TWS 35203
INT	Radiolucent 25mm x 120mm (1" x 4 3/4")	TWS 35204
INT	Radiolucent 25mm x 130mm (1" x 5 1/8")	TWS 35205
INT	Radiolucent 25mm x 140mm (1" x 5 1/2")	TWS 35206
INT	Radiolucent 25mm x 150mm (1" x 5 7/8")	TWS 35207
INT	Radiolucent 25mm x 160mm (1" x 6 1/4")	TWS 35208
INT	Radiolucent 25mm x 170mm (1" x 6 5/8")	TWS 35209
INT	Radiolucent 25mm x 180mm (1" x 7")	TWS 35210
INT	Radiolucent 25mm x 190mm (1" x 7 1/2")	TWS 35211
INT	Radiolucent 25mm x 200mm (1" x 7 7/8")	TWS 35212

Retractor Blades

RETRACTOR SYSTEM BLADES



S-Lock



INTERCH

ADVANCED MIS 18MM RENAL BLADES S-LOCK

TYPE	ITEM DESCRIPTION	Code
SO	Radiolucent 18mm x 80mm (¾" x 3 1/8")	TWS 35213
SO	Radiolucent 18mm x 90mm (¾" x 3 ½")	TWS 35214
SO	Radiolucent 18mm x 100mm (¾" x 4")	TWS 35215
SO	Radiolucent 18mm x 110mm (¾" x 4 3/8")	TWS 35216
SO	Radiolucent 18mm x 120mm (¾" x 4 ¾")	TWS 35217
SO	Radiolucent 18mm x 130mm (¾" x 5 1/8")	TWS 35218
SO	Radiolucent 18mm x 140mm (¾" x 5 ½")	TWS 35219
SO	Radiolucent 18mm x 150mm (¾" x 5 7/8")	TWS 35220
SO	Radiolucent 18mm x 160mm (¾" x 6 ¼")	TWS 35221
SO	Radiolucent 18mm x 170mm (¾" x 6 5/8")	TWS 35222
SO	Radiolucent 18mm x 180mm (¾" x 7")	TWS 35223
SO	Radiolucent 18mm x 190mm (¾" x 7 ½")	TWS 35224
SO	Radiolucent 18mm x 200mm (¾" x 7 7/8")	TWS 35225

ADVANCED MIS 18MM RENAL BLADES Interchange

TYPE	ITEM DESCRIPTION	Code
INT	Radiolucent 18mm x 80mm (¾" x 3 1/8")	TWS 35226
INT	Radiolucent 18mm x 90mm (¾" x 3 ½")	TWS 35227
INT	Radiolucent 18mm x 100mm (¾" x 4")	TWS 35228
INT	Radiolucent 18mm x 110mm (¾" x 4 3/8")	TWS 35229
INT	Radiolucent 18mm x 120mm (¾" x 4 ¾")	TWS 35230
INT	Radiolucent 18mm x 130mm (¾" x 5 1/8")	TWS 35231
INT	Radiolucent 18mm x 140mm (¾" x 5 ½")	TWS 35232
INT	Radiolucent 18mm x 150mm (¾" x 5 7/8")	TWS 35233
INT	Radiolucent 18mm x 160mm (¾" x 6 ¼")	TWS 35234
INT	Radiolucent 18mm x 170mm (¾" x 6 5/8")	TWS 35235
INT	Radiolucent 18mm x 180mm (¾" x 7")	TWS 35236
INT	Radiolucent 18mm x 190mm (¾" x 7 ½")	TWS 35237
INT	Radiolucent 18mm x 200mm (¾" x 7 7/8")	TWS 35238



S-Lock



Interchange

CONCAVE BLADE

TYPE	ITEM DESCRIPTION	Code
SO	Radiolucent 30mm x 60mm (1 1/8" x 2 3/8")	TWS 35239

CONCAVE BLADE

TYPE	ITEM DESCRIPTION	Code
INT	Radiolucent 30mm x 60mm (1 1/8" x 2 3/8")	TWS 35240

Retractor Blades

RETRACTOR SYSTEM BLADES



S-Lock

ADVANCED MIS REVERSE TAPERED BLADES S-Lock

TYPE	ITEM DESCRIPTION	Code
SO	Radiolucent 20mm x 100mm (3/4" x 4")	TWS 35241
SO	Radiolucent 20mm x 110mm (3/4" x 4 3/8")	TWS 35242
SO	Radiolucent 20mm x 120mm (3/4" x 4 3/4")	TWS 35243
SO	Radiolucent 20mm x 130mm (3/4" x 5 1/8")	TWS 35244
SO	Radiolucent 20mm x 140mm (3/4" x 5 1/2")	TWS 35245
SO	Radiolucent 20mm x 150mm (3/4" x 5 7/8")	TWS 35246
SO	Radiolucent 20mm x 160mm (3/4" x 6 1/4")	TWS 35247
SO	Radiolucent 20mm x 170mm (3/4" x 6 5/8")	TWS 35248
SO	Radiolucent 20mm x 180mm (3/4" x 7")	TWS 35249
SO	Radiolucent 20mm x 190mm (3/4" x 7 1/2")	TWS 35250
SO	Radiolucent 20mm x 200mm (3/4" x 7 7/8")	TWS 35251



INTERCH

ADVANCED MIS REVERSE TAPERED BLADES INTERCH

TYPE	ITEM DESCRIPTION	Code
INT	Radiolucent 20mm x 100mm (3/4" x 4")	TWS 35252
INT	Radiolucent 20mm x 110mm (3/4" x 4 3/8")	TWS 35253
INT	Radiolucent 20mm x 120mm (3/4" x 4 3/4")	TWS 35254
INT	Radiolucent 20mm x 130mm (3/4" x 5 1/8")	TWS 35255
INT	Radiolucent 20mm x 140mm (3/4" x 5 1/2")	TWS 35256
INT	Radiolucent 20mm x 150mm (3/4" x 5 7/8")	TWS 35257
INT	Radiolucent 20mm x 160mm (3/4" x 6 1/4")	TWS 35258
INT	Radiolucent 20mm x 170mm (3/4" x 6 5/8")	TWS 35259
INT	Radiolucent 20mm x 180mm (3/4" x 7")	TWS 35260
INT	Radiolucent 20mm x 190mm (3/4" x 7 1/2")	TWS 35261
INT	Radiolucent 20mm x 200mm (3/4" x 7 7/8")	TWS 35262



S-Lock

ADVANCED MIS FINE VESSEL BLADES S-Lock

TYPE	ITEM DESCRIPTION	Code
SO	Radiolucent 80mm (3 1/8")	TWS 35263
SO	Radiolucent 90mm (3 1/2")	TWS 35264
SO	Radiolucent 100mm (4")	TWS 35265
SO	Radiolucent 110mm (4 3/8")	TWS 35266
SO	Radiolucent 120mm (4 3/4")	TWS 35267
SO	Radiolucent 130mm (5 1/8")	TWS 35268
SO	Radiolucent 140mm (5 1/2")	TWS 35269
SO	Radiolucent 150mm (5 7/8")	TWS 35270
SO	Radiolucent 160mm (6 1/4")	TWS 35271
SO	Radiolucent 170mm (6 5/8")	TWS 35272
SO	Radiolucent 180mm (7")	TWS 35273
SO	Radiolucent 190mm (7 1/2")	TWS 35274
SO	Radiolucent 200mm (7 7/8")	TWS 35275



INTERCH

ADVANCED MIS FINE VESSEL BLADES INTERCH

TYPE	ITEM DESCRIPTION	Code
INT	Radiolucent 80mm (3 1/8")	TWS 35276
INT	Radiolucent 90mm (3 1/2")	TWS 35277
INT	Radiolucent 100mm (4")	TWS 35278
INT	Radiolucent 110mm (4 3/8")	TWS 35279
INT	Radiolucent 120mm (4 3/4")	TWS 35280
INT	Radiolucent 130mm (5 1/8")	TWS 35281
INT	Radiolucent 140mm (5 1/2")	TWS 35282
INT	Radiolucent 150mm (5 7/8")	TWS 35283
INT	Radiolucent 160mm (6 1/4")	TWS 35284
INT	Radiolucent 170mm (6 5/8")	TWS 35285
INT	Radiolucent 180mm (7")	TWS 35286
INT	Radiolucent 190mm (7 1/2")	TWS 35287
INT	Radiolucent 200mm (7 7/8")	TWS 35288

Retractor Blades

RETRACTOR SYSTEM BLADES



Anodized Aluminum S-Lock

RADIOLUCENT ODONTOID BLADES

TYPE	ITEM DESCRIPTION	Code
A.A/SO	Radiolucent 20mm x 90mm (¾" x 3 ½")	TWS 35289



S-Lock

RADIOLUCENT ODONTOID BLADES S-Lock

TYPE	ITEM DESCRIPTION	Code
SO	Radiolucent 20mm x 90mm (¾" x 3 ½")	TWS 35291



A.A Interchange

RADIOLUCENT ODONTOID BLADES

TYPE	REF	Code
A.A/INT	Radiolucent 20mm x 90mm (¾" x 3 ½")	TWS 35290



RADIOLUCENT ODONTOID BLADES

TYPE	REF	Code
INT	Radiolucent 20mm x 90mm (¾" x 3 ½")	TWS 35292



new Anodized Aluminum A.A S-Lock

RADIOLUCENT MIDLINE BLADES

TYPE	ITEM DESCRIPTION	Code
A.A/SO	Radiolucent Right 70mm x 83mm (2 ¾" x 3 ¼")	TWS 35293
A.A/SO	Radiolucent Left 70mm x 83mm (2 ¾" x 3 ¼")	TWS 35294



S-lock

RADIOLUCENT MIDLINE BLADES

TYPE	ITEM DESCRIPTION	Code
SO	Radiolucent Right 70mm x 83mm (2 ¾" x 3 ¼")	TWS 35299
SO	Radiolucent Left 70mm x 83mm (2 ¾" x 3 ¼")	TWS 35300

Retractor Blades



new Anodized Aluminum A.A Interchange

RADIOLOGENT MIDLINE BLADES

TYPE	ITEM DESCRIPTION	Code
A.A/INT	Radiolucent Right 70mm x 83mm (2 ¾" x 3 ¼")	TWS 35295
A.A/INT	Radiolucent Left 70mm x 83mm (2 ¾" x 3 ¼")	TWS 35296



ARMY-NAVY BLADES

TYPE	ITEM DESCRIPTION	Code
SO	13mm x 55mm (½" x 2 1/8")	TWS 35309
SO	13mm x 65mm (½" x 2 5/8")	TWS 35310
SO	13mm x 75mm (½" x 3 1/16")	TWS 35311



ARMY-NAVY BLADES Swivel

TYPE	ITEM DESCRIPTION	Code
SWL	13mm x 55mm (½" x 2 1/8")	TWS 35315
SWL	13mm x 75mm (½" x 3 1/16")	TWS 35316

RETRACTOR SYSTEM BLADES



left

RADIOLOGENT MIDLINE BLADES

TYPE	ITEM DESCRIPTION	Code
INT	Radiolucent Right 70mm x 83mm (2 ¾" x 3 ¼")	TWS 35297
INT	Radiolucent Left 70mm x 83mm (2 ¾" x 3 ¼")	TWS 35298

MIDLINE BLADES (RADIOPAQUE) Interchange

TYPE	ITEM DESCRIPTION	Code
INT	Right 70mm x 83mm (2 ¾" x 3 ¼")	TWS 35301
INT	Left 70mm x 83mm (2 ¾" x 3 ¼")	TWS 35302
INT	Left 57mm x 83mm (2 ¼" x 3 ¼")	TWS 35303
INT	Right 57mm x 83mm (2 ¼" x 3 ¼")	TWS 35304

MIDLINE BLADES (RADIOPAQUE) S Lock

TYPE	ITEM DESCRIPTION	Code
SO	Right 70mm x 83mm (2 ¾" x 3 ¼")	TWS 35305
SO	Left 70mm x 83mm (2 ¾" x 3 ¼")	TWS 35306
SO	Left 57mm x 83mm (2 ¼" x 3 ¼")	TWS 35307
SO	Right 57mm x 83mm (2 ¼" x 3 ¼")	TWS 35308



ARMY-NAVY BLADES Interchange

REF	ITEM DESCRIPTION	Code
SO	13mm x 55mm (½" x 2 1/8")	TWS 35312
SO	13mm x 65mm (½" x 2 5/8")	TWS 35313
SO	13mm x 75mm (½" x 3 1/16")	TWS 35314

Retractor Blades

RETRACTOR SYSTEM BLADES



Interchange



S-Lock

CONCAVE MEDIAL BLADES

TYPE	ITEM DESCRIPTION	Code
INT	13mm x 51mm (½" x 2")	TWS 35329
INT	13mm x 75mm (½" x 3")	TWS 35330
INT	13mm x 100mm (½" x 4")	TWS 35331
INT	19mm x 51mm (¾" x 2")	TWS 35332
INT	19mm x 75mm (¾" x 3")	TWS 35333
INT	19mm x 100mm (¾" x 4")	TWS 35334
INT	25mm x 51mm (1" x 2")	TWS 35335
INT	25mm x 75mm (1" x 3")	TWS 35336
INT	25mm x 100mm (1" x 4")	TWS 35337
INT	32mm x 70mm (1 ¼" x 2 ¾")	TWS 35338
INT	38mm x 70mm (1 ½" x 2 ¾")	TWS 35339
INT	38mm x 85mm (1 ½" x 3 ⅜")	TWS 35340

CONCAVE MEDIAL BLADES

TYPE	ITEM DESCRIPTION	Code
SO	13mm x 51mm (½" x 2")	TWS 35317
SO	13mm x 75mm (½" x 3")	TWS 35318
SO	13mm x 100mm (½" x 4")	TWS 35319
SO	19mm x 51mm (¾" x 2")	TWS 35320
SO	19mm x 75mm (¾" x 3")	TWS 35321
SO	19mm x 100mm (¾" x 4")	TWS 35322
SO	25mm x 51mm (1" x 2")	TWS 35323
SO	25mm x 75mm (1" x 3")	TWS 35324
SO	25mm x 100mm (1" x 4")	TWS 35325
SO	32mm x 70mm (1 ¼" x 2 ¾")	TWS 35326
SO	38mm x 70mm (1 ½" x 2 ¾")	TWS 35327
SO	38mm x 85mm (1 ½" x 3 ⅜")	TWS 35328



Interchange with teeth



Interchange



S-Lock

MEYERDING BLADES

TYPE	ITEM DESCRIPTION	Code
INT	16mm x 51mm (5/8" x 2")	TWS 35367
INT	16mm x 75mm (5/8" x 3")	TWS 35368
INT	16mm x 100mm (5/8" x 4")	TWS 35369
INT	25mm x 60mm (1" x 2 3/8")	TWS 35370
INT	25mm x 75mm (1" x 3")	TWS 35371
INT	25mm x 100mm (1" x 4")	TWS 35372
INT	51mm x 60mm (2" x 2 3/8")	TWS 35373
INT	25mm x 125mm (1" x 5")	TWS 35374

MEYERDING BLADES

TYPE	ITEM DESCRIPTION	Code
SO	16mm x 51mm (5/8" x 2")	TWS 35341
SO	16mm x 75mm (5/8" x 3")	TWS 35342
SO	16mm x 100mm (5/8" x 4")	TWS 35343
SO	25mm x 60mm (1" x 2 3/8")	TWS 35344
SO	25mm x 75mm (1" x 3")	TWS 35345
SO	25mm x 100mm (1" x 4")	TWS 35346
SO	25mm x 125mm (1" x 5")	TWS 35347
SO	51mm x 60mm (2" x 2 3/8")	TWS 35348

Retractor Blades

RETRACTOR SYSTEM BLADES

MEYERDING BLADES Cont

TYPE	ITEM DESCRIPTION	Code
INT	51mm x 75mm (2" x 3")	TWS 35375
INT	51mm x 125mm (2" x 5")	TWS 35376
INT	Radiolucent 51mm x 60mm (2" x 2 3/8")	TWS 35377
INT	With Teeth 16mm x 51mm (5/8" x 2")	TWS 35378
INT	With Teeth 16mm x 75mm (5/8" x 3")	TWS 35379
INT	With Teeth 16mm x 100mm (5/8" x 4")	TWS 35380
INT	With Teeth 25mm x 60mm (1" x 2 3/8")	TWS 35381
INT	With Teeth 25mm x 75mm (1" x 3")	TWS 35382
INT	With Teeth 25mm x 100mm (1" x 4") S	TWS 35383
INT	With Teeth 25mm x 115mm (1" x 4 1/2")	TWS 35384
INT	With Teeth 25mm x 125mm (1" x 5")	TWS 35385
INT	With Teeth 38mm x 165mm (1 1/2" x 6 1/2")	TWS 35386
INT	With Teeth 51mm x 75mm (2" x 3")	TWS 35387



S-Lock

CONCAVE POSTERIOR LUMBAR BLADES S-Lock (SO)

TYPE	ITEM DESCRIPTION	Code
SO	Radiolucent 23mm x 80mm (7/8" x 3 1/8")	TWS 35388
SO	Radiolucent 45mm x 80mm (1 3/4" x 3 1/8")	TWS 35389
SO	Radiolucent 60mm x 80mm (2 3/8" x 3 1/8")	TWS 35390
SO	Radiolucent 23mm x 100mm (7/8" x 4")	TWS 35391
SO	Radiolucent 45mm x 100mm (1 3/4" x 4")	TWS 35392
SO	Radiolucent 60mm x 100mm (2 3/8" x 4")	TWS 35393
SO	Radiolucent 23mm x 120mm (7/8" x 4 3/4")	TWS 35394
SO	Radiolucent 45mm x 120mm (1 3/4" x 4 3/4")	TWS 35395
SO	Radiolucent 60mm x 120mm (2 3/8" x 4 3/4")	TWS 35396
SO	Radiolucent 23mm x 150mm (7/8" x 5 7/8")	TWS 35397
SO	Radiolucent 45mm x 150mm (1 3/4" x 5 7/8")	TWS 35398
SO	Radiolucent 60mm x 150mm (2 3/8" x 5 7/8")	TWS 35399



MEYERDING BLADES Cont

TYPE	ITEM DESCRIPTION	Code
SO	51mm x 75mm (2" x 3")	TWS 35349
SO	51mm x 100mm (2" x 4")	TWS 35350
SO	51mm x 125mm (2" x 5")	TWS 35351
SO	Radiolucent 51mm x 60mm (2" x 2 3/8")	TWS 35352
SO	With Teeth 16mm x 51mm (5/8" x 2")	TWS 35353
SO	With Teeth 16mm x 75mm (5/8" x 3")	TWS 35354
SO	With Teeth 16mm x 100mm (5/8" x 4")	TWS 35355
SO	With Teeth 25mm x 60mm (1" x 2 3/8")	TWS 35356
SO	With Teeth 25mm x 75mm (1" x 3")	TWS 35357
SO	With Teeth 25mm x 100mm (1" x 4") S	TWS 35358
SO	With Teeth 25mm x 115mm (1" x 4 1/2")	TWS 35359
SO	With Teeth 25mm x 125mm (1" x 5")	TWS 35360
SO	With Teeth 38mm x 165mm (1 1/2" x 6 1/2")	TWS 35361
SO	With Teeth 51mm x 60mm (2" x 2 3/8")	TWS 35362
SO	With Teeth 51mm x 75mm (2" x 3")	TWS 35363
SO	With Teeth 51mm x 100mm (2" x 4")	TWS 35364
SO	With Teeth 51mm x 125mm (2" x 5")	TWS 35365
SO	Radiolucent with Teeth 51mm x 60mm (2" x 2 3/8")	TWS 35366



SWIVEL

MEYERDING BLADES

TYPE	ITEM DESCRIPTION	Code
SWL	16mm x 100mm (5/8" x 4")	TWS 35400
SWL	51mm x 125mm (2" x 5")	TWS 35401

CONCAVE POSTERIOR LUMBAR BLADES S-Lock (SO)

TYPE	ITEM DESCRIPTION	Code
SO	Radiolucent 23mm x 180mm (7/8" x 7")	TWS 35402
SO	Radiolucent 45mm x 180mm (1 3/4" x 7")	TWS 35403
SO	Radiolucent 60mm x 180mm (2 3/8" x 7")	TWS 35404



S-Lock

PRONG RETRACTORS

TYPE	ITEM DESCRIPTION	Code
SO	75mm (3")	TWS 35405
SO	100mm (4")	TWS 35406



Interchange

PRONG RETRACTORS

TYPE	ITEM DESCRIPTION	Code
INT	75mm (3")	TWS 35422
INT	100mm (4")	TWS 35423



45°

90°

Interchangeable

NERVE ROOT RETRACTORS

TYPE	ITEM DESCRIPTION	Code
INT	90° 5mm x 123mm (¼" x 4 7/8")	TWS 35424
INT	45° 8mm x 145mm (3/8" x 5 ¾")	TWS 35425
INT	Interchangeable 9mm x 114mm (3/8" x 4 ½")	TWS 35426
INT	Interchangeable 13mm x 114mm (½" x 4 ½")	TWS 35427



Interchange

CONCAVE POSTERIOR LUMBAR BLADES Interchang

TYPE	ITEM DESCRIPTION	Code
INT	Radiolucent 23mm x 80mm (7/8" x 3 1/8")	TWS 35407
INT	Radiolucent 45mm x 80mm (1 ¾" x 3 1/8")	TWS 35408
INT	Radiolucent 60mm x 80mm (2 3/8" x 3 1/8")	TWS 35409
INT	Radiolucent 23mm x 100mm (7/8" x 4")	TWS 35410
INT	Radiolucent 45mm x 100mm (1 ¾" x 4")	TWS 35411
INT	Radiolucent 60mm x 100mm (2 3/8" x 4")	TWS 35412
INT	Radiolucent 23mm x 120mm (7/8" x 4 ¾")	TWS 35413
INT	Radiolucent 45mm x 120mm (1 ¾" x 4 ¾")	TWS 35414
INT	Radiolucent 60mm x 120mm (2 3/8" x 4 ¾")	TWS 35415
INT	Radiolucent 23mm x 150mm (7/8" x 5 7/8")	TWS 35416
INT	Radiolucent 45mm x 150mm (1 ¾" x 5 7/8")	TWS 35417
INT	Radiolucent 60mm x 150mm (2 3/8" x 5 7/8")	TWS 35418
INT	Radiolucent 23mm x 180mm (7/8" x 7")	TWS 35419
INT	Radiolucent 45mm x 180mm (1 ¾" x 7")	TWS 35420
INT	Radiolucent 60mm x 180mm (2 3/8" x 7")	TWS 35421



FLEXIBLE BLADE HOLDER

TYPE	ITEM DESCRIPTION	Code
	Flexible Blade Holder with Cam Joint (used to hold Nerve Root Retractors)	TWS 35428

Retractor Blades

RETRACTOR SYSTEM BLADES



PERESS BLADES ** Interchange

TYPE	ITEM DESCRIPTION	Code
INT	35mm x 102mm (1 3/8" x 4")	TWS 35449
INT	35mm x 127mm (1 3/8" x 5")	TWS 35450
INT	35mm x 152mm (1 3/8" x 6")	TWS 35451
INT	60mm x 102mm (2 3/8" x 4")	TWS 35452
INT	60mm x 127mm (2 3/8" x 5")	TWS 35453
INT	60mm x 152mm (2 3/8" x 6")	TWS 35454

PERESS BLADES ** S-Lock

TYPE	ITEM DESCRIPTION	Code
SO	35mm x 102mm (1 3/8" x 4")	TWS 35443
SO	35mm x 127mm (1 3/8" x 5")	TWS 35444
SO	35mm x 152mm (1 3/8" x 6")	TWS 35445
SO	60mm x 102mm (2 3/8" x 4")	TWS 35446
SO	60mm x 127mm (2 3/8" x 5")	TWS 35447
SO	60mm x 152mm (2 3/8" x 6")	TWS 35448



RADIOLOGENT CONCAVE TAPERED BLADES

TYPE	ITEM DESCRIPTION	Code
AA/SO	Radiolucent 23mm x 30mm (1" x 1 1/8")	TWS 35455
AA/SO	Radiolucent 23mm x 35mm (1" x 1 3/8")	TWS 35456
AA/SO	Radiolucent 23mm x 40mm (1" x 1 1/2")	TWS 35457
AA/SO	Radiolucent 23mm x 45mm (1" x 1 3/4")	TWS 35458
AA/SO	Radiolucent 23mm x 50mm (1" x 2")	TWS 35459
AA/SO	Radiolucent 23mm x 55mm (1" x 2 1/8")	TWS 35460
AA/SO	Radiolucent 23mm x 60mm (1" x 2 3/8")	TWS 35461
AA/SO	Radiolucent 23mm x 65mm (1" x 2 1/2")	TWS 35462
AA/SO	Radiolucent 23mm x 70mm (1" x 2 3/4")	TWS 35463
AA/SO	Radiolucent 23mm x 75mm (1" x 3")	TWS 35464
AA/SO	Radiolucent 23mm x 80mm (1" x 3 1/8")	TWS 35465
AA/SO	Radiolucent with Teeth 23mm x 30mm (1" x 1 1/8")	TWS 35466
AA/SO	Radiolucent with Teeth 23mm x 35mm (1" x 1 3/8")	TWS 35467
AA/SO	Radiolucent with Teeth 23mm x 40mm (1" x 1 1/2")	TWS 35468
AA/SO	Radiolucent with Teeth 23mm x 45mm (1" x 1 3/4")	TWS 35469

RADIOLOGENT CONCAVE TAPERED BLADES

TYPE	ITEM DESCRIPTION	REF
AA/SO	Radiolucent with Teeth 23mm x 50mm (1" x 2")	TWS 35470
AA/SO	Radiolucent with Teeth 23mm x 55mm (1" x 2 1/8")	TWS 35471
AA/SO	Radiolucent with Teeth 23mm x 60mm (1" x 2 3/8")	TWS 35472
AA/SO	Radiolucent with Teeth 23mm x 65mm (1" x 2 1/2")	TWS 35473
AA/SO	Radiolucent with Teeth 23mm x 70mm (1" x 2 3/4")	TWS 35474
AA/SO	Radiolucent with Teeth 23mm x 75mm (1" x 3")	TWS 35475
AA/SO	Radiolucent with Teeth 23mm x 80mm (1" x 3 1/8")	TWS 35476

CONCAVE TAPERED BLADES (RADIOPAQUE)

TYPE	ITEM DESCRIPTION	Code
SO	19mm x 35mm (3/4" x 1 3/8")	TWS 35499
SO	19mm x 45mm (3/4" x 1 3/4")	TWS 35500
SO	19mm x 50mm (3/4" x 2")	TWS 35501
SO	45mm x 50mm (1 3/4" x 2")	TWS 35502
SO	45mm x 65mm (1 3/4" x 2 3/4")	TWS 35503
SWL	19mm x 45mm (3/4" x 1 3/4")	TWS 35509

Retractor Blades

RETRACTOR SYSTEM BLADES



new Color Coded (Anodized Aluminum) Interchange

RADIOLUCENT CONCAVE TAPERED BLADES

TYPE	ITEM DESCRIPTION	Code
A.A/INT	Radiolucent 23mm x 30mm (1" x 1 1/8")	TWS 35477
A.A/INT	Radiolucent 23mm x 35mm (1" x 1 3/8")	TWS 35478
A.A/INT	Radiolucent 23mm x 40mm (1" x 1 1/2")	TWS 35479
A.A/INT	Radiolucent 23mm x 45mm (1" x 1 3/4")	TWS 35480
A.A/INT	Radiolucent 23mm x 50mm (1" x 2")	TWS 35481
A.A/INT	Radiolucent 23mm x 55mm (1" x 2 1/8")	TWS 35482
A.A/INT	Radiolucent 23mm x 60mm (1" x 2 3/8")	TWS 35483
A.A/INT	Radiolucent 23mm x 65mm (1" x 2 1/2")	TWS 35484
A.A/INT	Radiolucent 23mm x 70mm (1" x 2 3/4")	TWS 35485
A.A/INT	Radiolucent 23mm x 75mm (1" x 3")	TWS 35486
A.A/INT	Radiolucent 23mm x 80mm (1" x 3 1/8")	TWS 35487
A.A/INT	Radiolucent 51mm x 50mm (2" x 2")	TWS 35488
A.A/INT	Radiolucent 51mm x 65mm (2" x 2 1/2")	TWS 35489
A.A/INT	Radiolucent with Teeth 23mm x 35mm (1" x 1 3/8")	TWS 35490
A.A/INT	Radiolucent with Teeth 23mm x 40mm (1" x 1 1/2")	TWS 35491
A.A/INT	Radiolucent with Teeth 23mm x 45mm (1" x 1 3/4")	TWS 35492

RADIOLUCENT CONCAVE TAPERED BLADES

TYPE	ITEM DESCRIPTION	Code
A.A/INT	Radiolucent with Teeth 23mm x 50mm (1" x 2")	TWS 35493
A.A/INT	Radiolucent with Teeth 23mm x 55mm (1" x 2 1/8")	TWS 35494
A.A/INT	Radiolucent with Teeth 23mm x 60mm (1" x 2 3/8")	TWS 35495
A.A/INT	Radiolucent with Teeth 23mm x 65mm (1" x 2 1/2")	TWS 35496
A.A/INT	Radiolucent with Teeth 23mm x 70mm (1" x 2 3/4")	TWS 35497
A.A/INT	Radiolucent with Teeth 23mm x 75mm (1" x 3")	TWS 35498
A.A/INT	Radiolucent with Teeth 23mm x 80mm (1" x 3 1/8")	TWS 35499

CONCAVE TAPERED BLADES (RADIOPAQUE)

TYPE	ITEM DESCRIPTION	Code
INT	19mm x 35mm (3/4" x 1 3/8")	TWS 35504
INT	19mm x 45mm (3/4" x 1 3/4")	TWS 35505
INT	19mm x 50mm (3/4" x 2")	TWS 35506
INT	45mm x 50mm (1 3/4" x 2")	TWS 35507
INT	45mm x 65mm (1 3/4" x 2 3/4")	TWS 35508



RADIOLUCENT CONCAVE LATERAL BLADES

TYPE	ITEM DESCRIPTION	Code
AA/SO	Radiolucent with Teeth 23mm x 30mm (1" x 1 1/8")	TWS 35510
AA/SO	Radiolucent with Teeth 23mm x 35mm (1" x 1 3/8")	TWS 35511
AA/SO	Radiolucent with Teeth 23mm x 40mm (1" x 1 1/2")	TWS 35512
AA/SO	Radiolucent with Teeth 23mm x 45mm (1" x 1 3/4")	TWS 35513
AA/SO	Radiolucent with Teeth 23mm x 50mm (1" x 2")	TWS 35514
AA/SO	Radiolucent with Teeth 23mm x 55mm (1" x 2 1/8")	TWS 35515

RADIOLUCENT CONCAVE LATERAL BLADES

TYPE	ITEM DESCRIPTION	Code
AA/SO	Radiolucent with Teeth 23mm x 60mm (1" x 2 3/8")	TWS 35516
AA/SO	Radiolucent with Teeth 23mm x 65mm (1" x 2 1/2")	TWS 35517
AA/SO	Radiolucent with Teeth 23mm x 70mm (1" x 2 3/4")	TWS 35518
AA/SO	Radiolucent with Teeth 23mm x 75mm (1" x 3")	TWS 35519
AA/SO	Radiolucent with Teeth 23mm x 80mm (1" x 3 1/8")	TWS 35520

Retractor Blades

RETRACTOR SYSTEM BLADES

RADIOLUCENT CONCAVE LATERAL BLADES WITH TEETH

TYPE	ITEM DESCRIPTION	Code
AA/SO	Radiolucent with Teeth 23mm x 30mm (1" x 1 1/8")	TWS 35548
AA/SO	Radiolucent with Teeth 23mm x 35mm (1" x 1 3/8")	TWS 35549
AA/SO	Radiolucent with Teeth 23mm x 40mm (1" x 1 1/2")	TWS 35550
AA/SO	Radiolucent with Teeth 23mm x 45mm (1" x 1 3/4")	TWS 35551
AA/SO	Radiolucent with Teeth 23mm x 50mm (1" x 2")	TWS 35552
AA/SO	Radiolucent with Teeth 23mm x 55mm (1" x 2 1/8")	TWS 35553
AA/SO	Radiolucent with Teeth 23mm x 60mm (1" x 2 3/8")	TWS 35554
AA/SO	Radiolucent with Teeth 23mm x 65mm (1" x 2 1/2")	TWS 35555
AA/SO	Radiolucent with Teeth 23mm x 70mm (1" x 2 3/4")	TWS 35556
AA/SO	Radiolucent with Teeth 23mm x 75mm (1" x 3")	TWS 35557
AA/SO	Radiolucent with Teeth 23mm x 80mm (1" x 3 1/8")	TWS 35558



RADIOLUCENT CONCAVE LATERAL BLADES

TYPE	ITEM DESCRIPTION	Code
A.A/INT	Radiolucent 23mm x 30mm (1" x 1 1/8")	TWS 35521
A.A/INT	Radiolucent 23mm x 35mm (1" x 1 3/8")	TWS 35522
A.A/INT	Radiolucent 23mm x 40mm (1" x 1 1/2")	TWS 35523
A.A/INT	Radiolucent 23mm x 45mm (1" x 1 3/4")	TWS 35524
A.A/INT	Radiolucent 23mm x 50mm (1" x 2")	TWS 35525
A.A/INT	Radiolucent 23mm x 55mm (1" x 2 1/8")	TWS 35526
A.A/INT	Radiolucent 23mm x 60mm (1" x 2 3/8")	TWS 35527
A.A/INT	Radiolucent 23mm x 65mm (1" x 2 1/2")	TWS 35528
A.A/INT	Radiolucent 23mm x 70mm (1" x 2 3/4")	TWS 35529
A.A/INT	Radiolucent 23mm x 75mm (1" x 3")	TWS 35530
A.A/INT	Radiolucent 23mm x 80mm (1" x 3 1/8")	TWS 35531

CONCAVE LATERAL BLADES (RADIOPAQUE)

TYPE	ITEM DESCRIPTION	Code
SO	18mm x 70mm (5/8" x 2 3/4")	TWS 35532
SO	19mm x 55mm (3/4" x 2 1/4")	TWS 35533
SO	25mm x 30mm (1" x 1 1/4")	TWS 35534
SO	25mm x 35mm (1" x 1 1/2")	TWS 35535
SO	25mm x 50mm (1" x 2")	TWS 35536
SO	25mm x 60mm (1" x 2 3/8")	TWS 35537
SO	25mm x 70mm (1" x 2 3/4")	TWS 35538
SO	25mm x 85mm (1" x 3 3/8")	TWS 35539

RADIOLUCENT CONCAVE LATERAL BLADES WITH TEETH

TYPE	ITEM DESCRIPTION	Code
A.A/INT	Radiolucent with Teeth 23mm x 30mm (1" x 1 1/8")	TWS 35559
A.A/INT	Radiolucent with Teeth 23mm x 35mm (1" x 1 3/8")	TWS 35560
A.A/INT	Radiolucent with Teeth 23mm x 40mm (1" x 1 1/2")	TWS 35561
A.A/INT	Radiolucent with Teeth 23mm x 45mm (1" x 1 3/4")	TWS 35562
A.A/INT	Radiolucent with Teeth 23mm x 50mm (1" x 2")	TWS 35563
A.A/INT	Radiolucent with Teeth 23mm x 55mm (1" x 2 1/8")	TWS 35564
A.A/INT	Radiolucent with Teeth 23mm x 60mm (1" x 2 3/8")	TWS 35565
A.A/INT	Radiolucent with Teeth 23mm x 65mm (1" x 2 1/2")	TWS 35566
A.A/INT	Radiolucent with Teeth 23mm x 70mm (1" x 2 3/4")	TWS 35567
A.A/INT	Radiolucent with Teeth 23mm x 75mm (1" x 3")	TWS 35568
A.A/INT	Radiolucent with Teeth 23mm x 80mm (1" x 3 1/8")	TWS 35569

CONCAVE LATERAL BLADES (RADIOPAQUE)

TYPE	ITEM DESCRIPTION	Code
INT	18mm x 70mm (5/8" x 2 3/4")	TWS 35540
INT	19mm x 55mm (3/4" x 2 1/4")	TWS 35541
INT	25mm x 30mm (1" x 1 1/4")	TWS 35542
INT	25mm x 35mm (1" x 1 1/2")	TWS 35543
INT	25mm x 50mm (1" x 2")	TWS 35544
INT	25mm x 60mm (1" x 2 3/8")	TWS 35545
INT	25mm x 70mm (1" x 2 3/4")	TWS 35546
INT	25mm x 85mm (1" x 3 3/8")	TWS 35547



RADIOLUCENT CONCAVE LONGITUDINAL BLADES

TYPE	ITEM DESCRIPTION	Code
SO	Radiolucent 23mm x 30mm (1" x 1 1/4")	TWS 35570
SO	Radiolucent 23mm x 40mm (1" x 2")	TWS 35571
SO	Radiolucent 23mm x 50mm (1" x 2 3/4")	TWS 35572
SO	Radiolucent 23mm x 60mm (1" x 2 3/8")	TWS 35573
SO	Radiolucent 23mm x 70mm (1" x 2 3/4")	TWS 35574
SO	Radiolucent 23mm x 80mm (1" x 3 1/8")	TWS 35575

CONCAVE LONGITUDINAL BLADES (RADIOPAQUE)

TYPE	ITEM DESCRIPTION	Code
INT	23mm x 30mm (1" x 1 1/4")	TWS 35585
INT	23mm x 50mm (1" x 2")	TWS 35586
INT	23mm x 70mm (1" x 2 3/4")	TWS 35587

CONCAVE LONGITUDINAL BLADES (RADIOPAQUE)

TYPE	ITEM DESCRIPTION	Code
SO	23mm x 30mm (1" x 1 1/4")	TWS 35582
SO	23mm x 50mm (1" x 2")	TWS 355-83
SO	23mm x 70mm (1" x 2 3/4")	TWS 35584

RADIOLUCENT CONCAVE LONGITUDINAL BLADES

TYPE	ITEM DESCRIPTION	Code
INT	Radiolucent 23mm x 30mm (1" x 1 1/4")	TWS 35576
INT	Radiolucent 23mm x 40mm (1" x 2")	TWS 35577
INT	Radiolucent 23mm x 50mm (1" x 2 3/4")	TWS 35578
INT	Radiolucent 23mm x 60mm (1" x 2 3/8")	TWS 35579
INT	Radiolucent 23mm x 70mm (1" x 2 3/4")	TWS 35580
INT	Radiolucent 23mm x 80mm (1" x 3 1/8")	TWS 35581

Retractor Blades

RETRACTOR SYSTEM BLADES



RADIOLUCENT CONCAVE MICRO BLADES AA S Lock

TYPE	ITEM DESCRIPTION	Code
AA/SO	Radiolucent 14mm x 30mm	TWS 35588
AA/SO	Radiolucent 14mm x 35mm (½" x 1 3/8")	TWS 35589
AA/SO	Radiolucent 14mm x 40mm (½" x 1 ½")	TWS 35590
AA/SO	Radiolucent 14mm x 45mm (½" x 1 ¾")	TWS 35591
AA/SO	Radiolucent 14mm x 50mm (½" x 2") S	TWS 35592
AA/SO	Radiolucent 14mm x 55mm (½" x 2 1/8")	TWS 35593
AA/SO	Radiolucent 14mm x 60mm (½" x 2 3/8")	TWS 35594
AA/SO	Radiolucent 14mm x 65mm (½" x 2 ½")	TWS 35595
AA/SO	Radiolucent 14mm x 70mm (½" x 2 ¾")	TWS 35596
AA/SO	Radiolucent 14mm x 75mm (½" x 3")	TWS 35597
AA/SO	Radiolucent 14mm x 80mm (½" x 3 1/8")	TWS 35598
AA/SO	Radiolucent with Teeth 14mm x 30mm (½" x 1 1/8")	TWS 35599
AA/SO	Radiolucent with Teeth 14mm x 35mm (½" x 1 3/8")	TWS 35600
AA/SO	Radiolucent with Teeth 14mm x 40mm (½" x 1 ½")	TWS 35601
AA/SO	Radiolucent with Teeth 14mm x 45mm (½" x 1 ¾")	TWS 35602
AA/SO	Radiolucent with Teeth 14mm x 50mm (½" x 2")	TWS 35603
AA/SO	Radiolucent with Teeth 14mm x 55mm (½" x 2 1/8")	TWS 35604
AA/SO	Radiolucent with Teeth 14mm x 60mm (½" x 2 3/8")	TWS 35605
AA/SO	Radiolucent with Teeth 14mm x 65mm (½" x 2 ½")	TWS 35606
AA/SO	Radiolucent with Teeth 14mm x 70mm (½" x 2 ¾")	TWS 35607
AA/SO	Radiolucent with Teeth 14mm x 75mm (½" x 3")	TWS 35608
AA/SO	Radiolucent with Teeth 14mm x 80mm (½" x 3 1/8")	TWS 35609

RADIOLUCENT CONCAVE MICRO BLADES AA Inter

TYPE	ITEM DESCRIPTION	Code
A.A/INT	Radiolucent 14mm x 35mm (½" x 1 3/8")	TWS 35610
A.A/INT	Radiolucent 14mm x 40mm (½" x 1 ½")	TWS 35611
A.A/INT	Radiolucent 14mm x 45mm (½" x 1 ¾")	TWS 35612
A.A/INT	Radiolucent 14mm x 50mm (½" x 2") S	TWS 35613
A.A/INT	Radiolucent 14mm x 55mm (½" x 2 1/8")	TWS 35614
A.A/INT	Radiolucent 14mm x 60mm (½" x 2 3/8")	TWS 35615
A.A/INT	Radiolucent 14mm x 65mm (½" x 2 ½")	TWS 35616
A.A/INT	Radiolucent 14mm x 70mm (½" x 2 ¾")	TWS 35617
A.A/INT	Radiolucent 14mm x 75mm (½" x 3")	TWS 35618
A.A/INT	Radiolucent 14mm x 80mm (½" x 3 1/8")	TWS 35619
A.A/INT	Radiolucent with Teeth 14mm x 35mm (½" x 1 3/8")	TWS 35620
A.A/INT	Radiolucent with Teeth 14mm x 40mm (½" x 1 ½")	TWS 35621
A.A/INT	Radiolucent with Teeth 14mm x 45mm (½" x 1 ¾")	TWS 35622
A.A/INT	Radiolucent with Teeth 14mm x 50mm (½" x 2")	TWS 35623
A.A/INT	Radiolucent with Teeth 14mm x 55mm (½" x 2 1/8")	TWS 35624
A.A/INT	Radiolucent with Teeth 14mm x 60mm (½" x 2 3/8")	TWS 35625
A.A/INT	Radiolucent with Teeth 14mm x 65mm (½" x 2 ½")	TWS 35626
A.A/INT	Radiolucent with Teeth 14mm x 70mm (½" x 2 ¾")	TWS 35627
A.A/INT	Radiolucent with Teeth 14mm x 75mm (½" x 3")	TWS 35628
A.A/INT	Radiolucent with Teeth 14mm x 80mm (½" x 3 1/8")	TWS 35629

ANTERIOR LUMBAR RING

UNIQUE SYSTEM COMPONENTS



EXTENSION ARM (CURRENT)

ITEM DESCRIPTION	Code #
Extension Arm with Fixed Hinge Joint	TWS 35630



RAIL CLAMP WITH EXTENSION ARM (CURRENT)

ITEM DESCRIPTION	Code #
Elite III Rail Clamp with Extension Arm Fixed Hinge Joint	TWS 35632



FREE ANGLE HANDLE (CURRENT)

TYPE	ITEM DESCRIPTION	REF
S Lock	Free Angle Handle 8"	TWS 35634

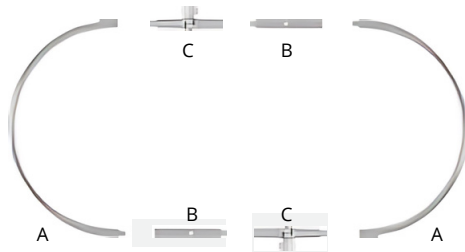

RING FRAME (CURRENT)

REF	ITEM DESCRIPTION	Code #
A	Ring Frame Half 13 1/2" (2 required for use)	TWS 35638
B	Ring Extension 4"	TWS 35639
C	Ring Extension Hinged 4"	TWS 35640



DUAL ANGLE HANDLE (CURRENT)

TYPE	ITEM DESCRIPTION	REF
SO	Dual Angle Handle 8"	TWS 35631



DUAL ANGLE HANDLE (CURRENT)

TYPE	ITEM DESCRIPTION	Code #
INT	Dual Angle Handle 8"	TWS 35633



FREE ANGLE HANDLE (CURRENT)

TYPE	ITEM DESCRIPTION	Code #
INT	Free Angle Handle 8"	TWS 35635



CIRCLE JOINT (CURRENT)

ITEM DESCRIPTION	Code #
Circle Joint 1/2" x 1/4"	TWS 35636



HEX TOOL WITH T-HANDLE (CURRENT)

ITEM DESCRIPTION	Code #
Hex Tool 3/16" with T-Handle	TWS 35637

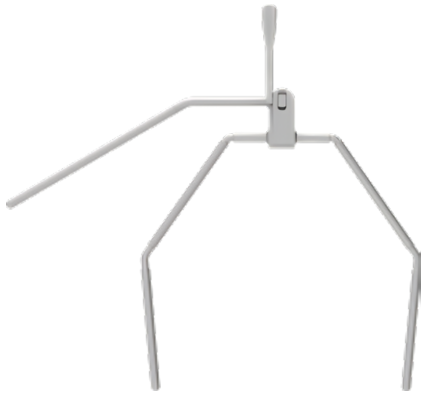

ONEFRAME®

ITEM DESCRIPTION	Code #
TWS OneFrame®	TWS 35641



RINGTRACK® ELITE III RAIL CLAMPS

REF	ITEM DESCRIPTION	Code #
A	RingTrack Elite III Rail Clamp 11" with 1 Cam Joint	TWS 35646
	RingTrack Elite III Rail Clamp 16" with 1 Cam Joint	TWS 35647
B	RingTrack Elite III Rail Clamp 18" with 1 Cam Joint	TWS 35648
	RingTrack Elite III Rail Clamp 22" with 1 Cam Joint	TWS 35649
	RingTrack Elite III Rail Clamp 26" with 1 Cam Joint	TWS 35650

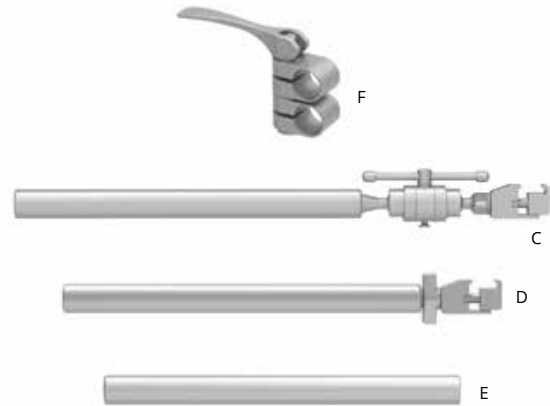

RINGTRACK® HORIZONTAL BARS

TYPE	ITEM DESCRIPTION	Code #
C	RingTrack Articulating Horizontal Bar 18 ½"	TWS 35642
D	RingTrack Horizontal Bar 14 ¼"	TWS 35643
E	RingTrack Extension Bar 12"	TWS 35644
F	RingTrack Cam III Joint 1" x 1"	TWS 35645

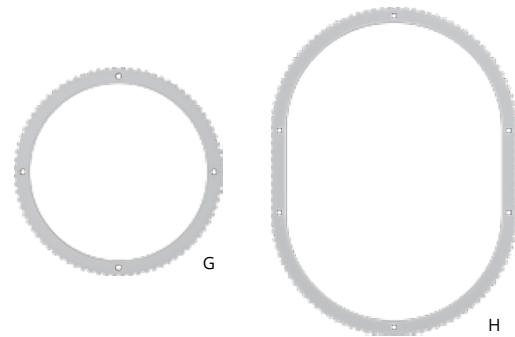

RINGTRACK® RINGS

REF	ITEM DESCRIPTION	PART #
G	RingTrack Round Ring Small 8 ½"	TWS 35651
	RingTrack Round Ring Medium 10 ½"	TWS 35652
	RingTrack Round Ring Large 12 ½"	TWS 35653
	RingTrack Oval Ring Small 8" x 12 ¼"	TWS 35654
H	RingTrack Oval Ring Medium 10 ½" x 14 ½"	TWS 35655
	RingTrack Oval Ring Large 12" x 18 ½"	TWS 35656

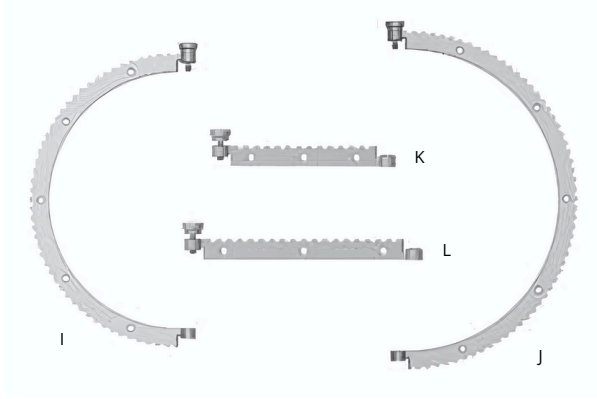

RINGTRACK® SEGMENTED RINGS

REF	ITEM DESCRIPTION	Code #
	RingTrack Round Ring Small Half 8 ½"	TWS 35657
I	RingTrack Round Ring Medium Half 10 ½"	TWS 35658
J	RingTrack Round Ring Large Half 12 ½"	TWS 35659
	RingTrack Straight Segment 4 ½"	TWS 35660
K	RingTrack Straight Segment 6"	TWS 35661
L	RingTrack Straight Segment 8"	TWS 35662



RINGTRACK® RATCHETS

REF	ITEM DESCRIPTION	Code #
M	RingTrack Ratchet	TWS 35663
N	RingTrack Ratchet with Clip	TWS 35664
O	RingTrack Angling Ratchet	TWS 35665
P	RingTrack Angling Ratchet with Clip	TWS 35666

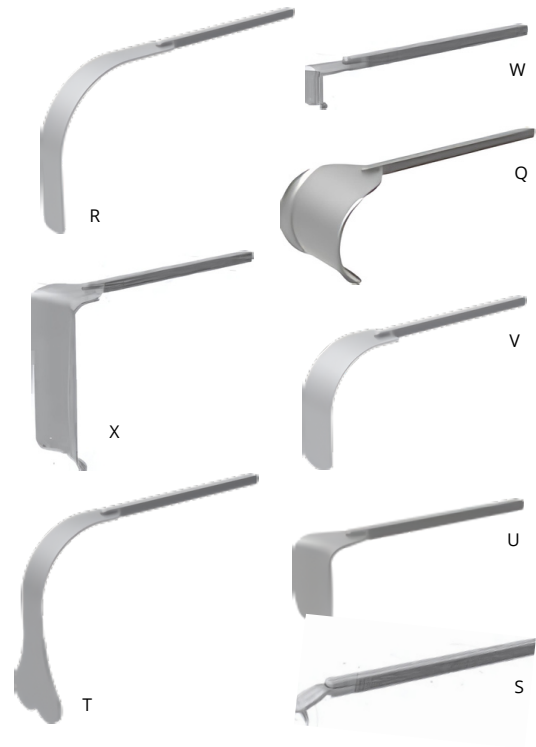

RINGTRACK® FIXED BLADES

REF	ITEM DESCRIPTION	Code #
Q	RingTrack Balfour [small lips] 83mm x 73mm (3 ¼" x 3")	TWS 35667
R	RingTrack Deaver 25mm x 127mm (1" x 5")z	TWS 35668
S	RingTrack Gelpi ½"	TWS 35669
T	RingTrack Harrington 64mm x 152mm (2 ½" x 6")	TWS 35670
U	RingTrack Kelly 51mm x 64mm (2" x 2 ½")z	TWS 35671
V	RingTrack Malleable 38mm x 152mm (1 ½" x 6")z	TWS 35672
	RingTrack Malleable 51mm x 165mm (2" x 6 ½")z	TWS 35673
	RingTrack Malleable 76mm x 165mm (3" x 6 ½")z	TWS 35674
W	RingTrack Richardson 19mm x 25mm (¾" x 1")z	TWS 35675
	RingTrack Richardson 19mm x 51mm (¾" x 2")z	TWS 35676
	RingTrack Richardson 44mm x 51mm (1 ¾" x 2")z	TWS 35677
	RingTrack Richardson 51mm x 76mm (2" x 3")z	TWS 35678
	RingTrack Richardson 51mm x 102mm (2" x 4")z	TWS 35679
X	RingTrack Richardson 51mm x 127mm (2" x 5")	TWS 35680
	RingTrack Richardson 51mm x 152mm (2" x 6")	TWS 35681

LAPAROSCOPIC

UNIQUE SYSTEM COMPONENTS

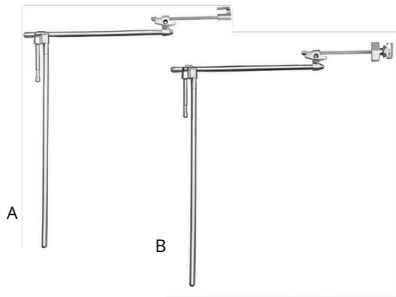

RIGID LAP HOLDERS FOR PRC (CURRENT)

REF	ITEM DESCRIPTION	Code #
A	Universal Rigid Lap Holder for Power Rail Clamp	TWS 35682
B	Rigid Laparoscopic Holder for Power Rail Clamp	TWS 35683

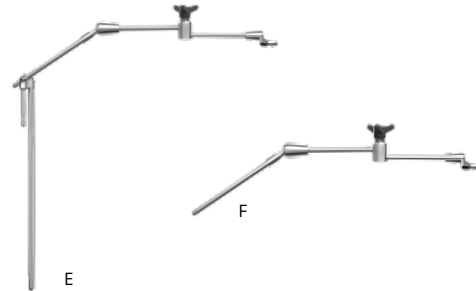

LAPAROSCOPIC ARTICULATING ARMS (CURRENT)

REF	ITEM DESCRIPTION	Code #
E	Laparoscopic Articulating Arm for Power Rail Clamp	TWS 35689
F	Laparoscopic Articulating Arm for Elite (or IHRC)	TWS 35690

OLDER GEN. RIGID LAPAROSCOPIC HOLDERS

ITEM DESCRIPTION	Code #
Laparoscopic Instrument Holder	TWS 35684
Instrument Holder	TWS 35685
Laparoscopic Instrument Holder	TWS 35686

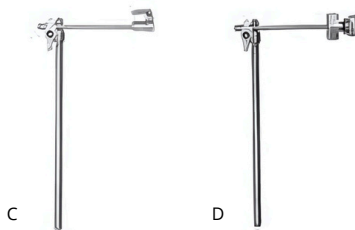

RIGID LAP HOLDERS FOR ELITE (CURRENT)

REF	ITEM DESCRIPTION	Code #
C	Universal Rigid Lap Holder for Elite (or IHRC)	TWS 35687
D	Rigid Laparoscopic Holder for Elite (or IHRC)	TWS 35688



FLEXIBLE LAPAROSCOPIC HOLDERS (CURRENT)

REF	ITEM DESCRIPTION	Code #
G	Flexible Laparoscopic Holder for Power Rail Clamp	TWS 35691
H	Flexible Laparoscopic Holder for Elite (or IHRC)	TWS 35692

LAPAROSCOPIC

UNIQUE SYSTEM COMPONENTS

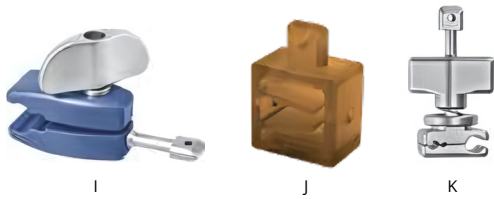

LAPAROSCOPIC ATTACHMENTS (CURRENT)

REF	ITEM DESCRIPTION	Code #
I	Adjustable Scope Grip	TWS 35693
J	Scope Clip 5mm *	TWS 35694
	Scope Clip 7mm *	TWS 35695
	Scope Clip 10mm *	TWS 35696
	Scope Clip 11mm *	TWS 35697
K	Duo Head with Tool Grasp Knob 3/5/10mm	TWS 35696

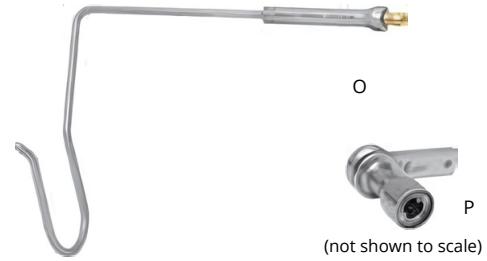

S-LOCK® NATHANSON HOOKS (CURRENT)

REF	ITEM DESCRIPTION	Code #
	S-Lock Small 5mm (169mm x 125mm x 12mm)	TWS 35701
O	S-Lock Medium 5mm (203mm x 167mm x 16mm)	TWS 35702
	S-Lock Large 5mm (240mm x 222mm x 21mm)	TWS 35703
	S-Lock Small 6 ½mm (169mm x 125mm x 12mm)	TWS 35704
	S-Lock Medium 6 ½mm (203mm x 167mm x 16mm)	TWS 35705
	S-Lock Large 6 ½mm (240mm x 222mm x 21mm)	TWS 35706
P	S-Lock Nathanson Adapter	TWS 35707

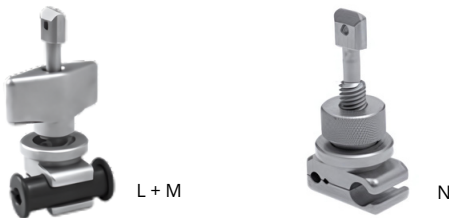

OLDER GEN. LAPAROSCOPIC ATTACHMENTS

REF	ITEM DESCRIPTION	Code #
L	Scope Grip	TWS 35697
M	Scope Grip Bushing 5mm **	TWS 35698
	Scope Grip Bushing 10mm	TWS 35699
N	Duo Head 3/5/10mm	TWS 35700



NATHANSON HOOKS (CURRENT)

REF	ITEM DESCRIPTION	Code #
	Small 5mm (169mm x 125mm x 12mm)	TWS 35708
Q	Medium 5mm (203mm x 167mm x 16mm)	TWS 35709
	Large 5mm (240mm x 222mm x 21mm)	TWS 35710
	Small 6 ½mm (169mm x 125mm x 12mm)	TWS 35711
	Medium 6 ½mm (203mm x 167mm x 16mm)	TWS 35712
	Large 6 ½mm (240mm x 222mm x 21mm)	TWS 35713

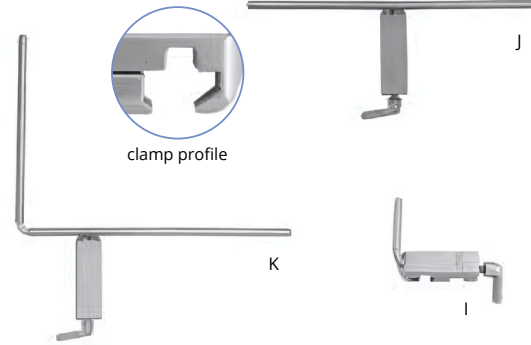
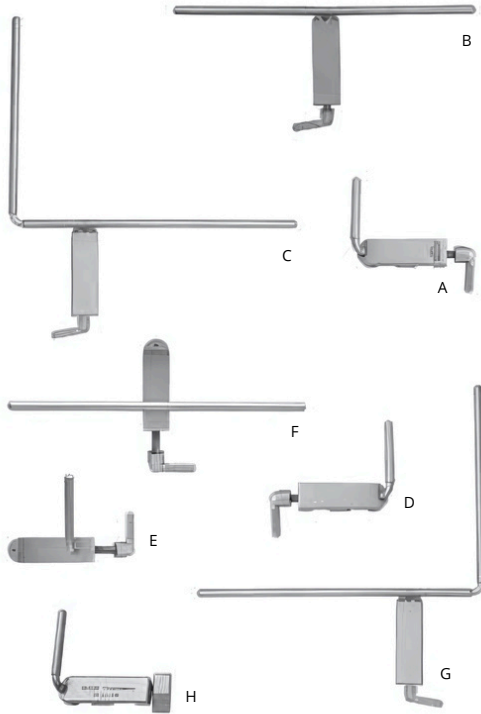

RECESSED ATTACHMENTS (CURRENT) *

REF	ITEM DESCRIPTION	Code #
I	CV Clamp L-Bar Recess 2" (51mm)	TWS 35724
J	CV Clamp T-Bar Recess 8" (203mm)	TWS 35725
K	CV Clamp L-Bar Recess 6" x 8" (152mm x 203mm)	TWS 35726
	CV Clamp Mini L-Bar Recess Reversed 2" (51mm)	TWS 35727
	CV Clamp Mini L-Bar Recess Offset 2" (51mm)	TWS 35728
	CV Clamp T-Bar Recess Offset 8" (203mm)	TWS 35729
	CV Clamp L-Bar Recess Reversed 6" x 8" (152mm x 203mm)	TWS 35730

ATTACHMENTS (CURRENT)

REF	ITEM DESCRIPTION	Code #
A	CV Clamp L-Bar 2" (51mm)	TWS 35714
B	CV Clamp T-Bar 8" (203mm)	TWS 35715
C	CV Clamp L-Bar 6" x 8" (152mm x 203mm)	TWS 35716
D	CV Clamp Mini L-Bar Reversed 2" (51mm)	TWS 35717
E	CV Clamp Mini L-Bar Offset 2" (51mm)	TWS 35718
F	CV Clamp T-Bar Offset 8" (203mm)	TWS 35719
G	CV Clamp L-Bar Reversed 6" x 8" (152mm x 203mm)	TWS 35720

OLDER GENERATION ATTACHMENTS

REF	ITEM DESCRIPTION	Code #
H	CV Clamp L-Bar 2" (51mm)	TWS 35721
	CV Clamp T-Bar 8" (203mm)	TWS 35722
	CV Clamp L-Bar 6" x 8" (152mm x 203mm)	TWS 35723



STERNAL SPREADERS (CURRENT)

ITEM DESCRIPTION	Code #
Morse Sternal Spreader Blades 28mm (w) x 22mm (d) (1 1/8" x 7/8")	TWS 35731
Morse Sternal Spreader-Large Blades 28mm (w) x 38mm (d) (1 1/8" x 1 1/2")	TWS 35732

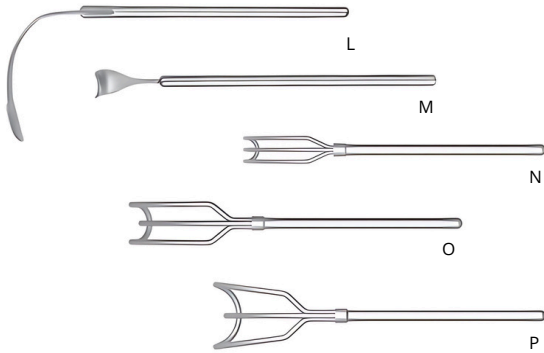

RETRACTORS (CURRENT)

REF	ITEM DESCRIPTION	Code #
	Malleable Paddle 5" (127mm)	TWS 35733
L	Malleable Paddle 6 ½" (165mm)	TWS 35734
	Malleable Paddle 8" (203mm)	TWS 35735
	Cushing 5" (127mm)	TWS 35736
M	Cushing 6 ½" (165mm)	TWS 35737
	Cushing 8" (203mm)	TWS 35738
	Basket Small 5" (127mm)	TWS 35739
N	Basket Small 6 ½" (165mm)	TWS 35740
	Basket Small 8" (203mm)	TWS 35741
	Basket Medium 5" (127mm)	TWS 35742
O	Basket Medium 6 ½" (165mm)	TWS 35743
	Basket Medium 8" (203mm)	TWS 35744
	Basket Large 5" (127mm)	TWS 35745
P	Basket Large 6 ½" (165mm)	TWS 35746
	Basket Large 8" (203mm)	TWS 35747



DRAKE HOOK (CURRENT)

ITEM DESCRIPTION	Code #
Drake Hook 258mm (10")	TWS 35751



UNIVERSAL JOINT (CURRENT)

ITEM DESCRIPTION	Code #
Universal Joint	TWS 35748

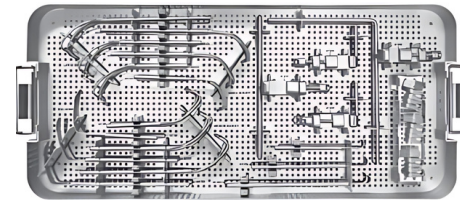

ORGANIZED INSTRUMENT TRAY - BOLLING MITRAL VALVE (CURRENT)

ITEM DESCRIPTION	Code #
Bolling	TWS 35749

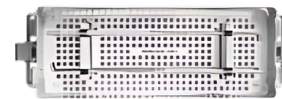

INSTRUMENT TRAY - DRAKE HOOK (CURRENT)

ITEM DESCRIPTION	Code #
Drake Hook	TWS 35750

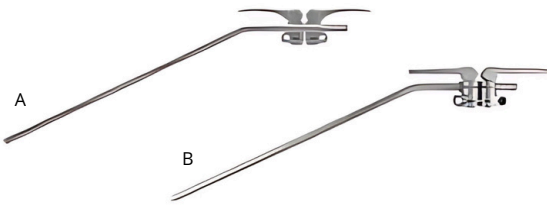

HIP CROSSBAR (CURRENT)

REF	ITEM DESCRIPTION	Code #
A	26" Crossbar w/ 2 Cam III Joints	TWS 35752
	22" Crossbar w/ 2 Cam III Joints	TWS 35753

OLDER GENERATION HIP CROSSBAR

REF	ITEM DESCRIPTION	Code #
B	Crossbar w/ 2 Cam Joints 7" x 19 1/2"	TWS 35754

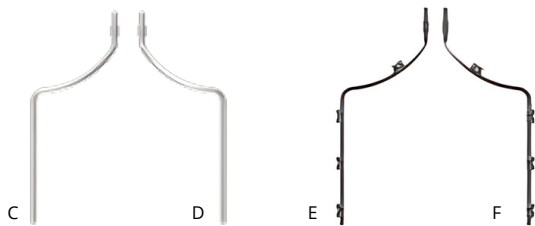

CURVED ARMS (CURRENT)

REF	ITEM DESCRIPTION	Code #
C	20" Curved Arm 1	TWS 35755
D	20" Curved Arm 2	TWS 35756
E	20" Curved Arm 1 with Cleats	TWS 35757
F	20" Curved Arm 2 with Cleats	TWS 35758



CLIP-ON HIP CLEAT (CURRENT)

ITEM DESCRIPTION	Code #
Clip-on Joint with Cleat	TWS 35770

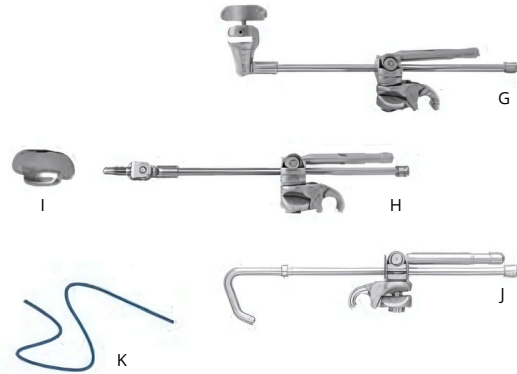

HIP HANDLES + TETHERS (CURRENT)

REF	ITEM DESCRIPTION	Code #
G	Cam II Clip-On Blade Adapter 8 1/2"	TWS 35759
H	Orthopedic Cam II Clip-On 8 1/2"	TWS 35760
I	Orthopedic Retractor Handle Knob	TWS 35761
J	Orthopedic Cam II Clip-On Hook 8 1/2"	TWS 35762
K	Hip Tethers (5 Pack)	TWS 35763

OLDER GENERATION HIP HANDLES

ITEM DESCRIPTION	Code #
Cam II Clip-On Blade Adapter 8 1/2"	TWS 35764
Orthopedic Cam II Clip-On 8 1/2"	TWS 35765

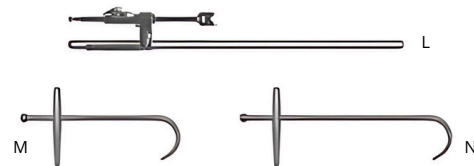

FEMUR ELEVATORS (CURRENT)

REF	ITEM DESCRIPTION	Code #
L	20" Straight Arm with Elevator Handle	TWS 35766
	25" Straight Arm with Elevator Handle	TWS 35767
M	Femur Hook 9"	TWS 35768
N	Femur Hook 12"	TWS 35769

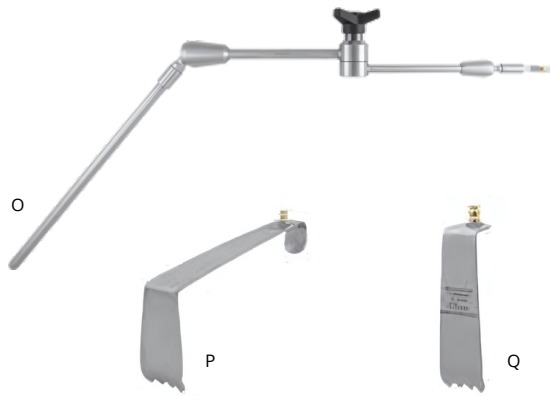

SL ARTICULATING ARM + HIBBS BLADES (CURRENT)

REF	ITEM DESCRIPTION	Code #
O	S-Lock Articulating Arm	TWS 35771
P	Hibbs with Teeth Long 25mm x 75mm	TWS 35772
	Hibbs with Teeth 25mm x 75mm (1" x 3")	TWS 35773
Q	Hibbs with Teeth 25mm x 115mm (1" x 4 1/2")	TWS 35774
	Hibbs with Teeth 25mm x 165mm (1" x 6 1/2")	TWS 35775

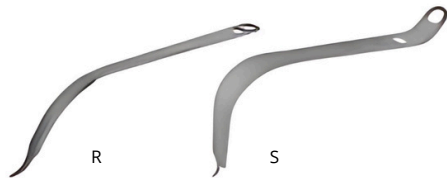

HOHMANN BLADES (CURRENT)

REF	ITEM DESCRIPTION	Code #
R	Hohmann Hip Blade 11"	TWS 35776
	Curved Hohmann Narrow Hip Blade 12"	TWS 35777
S	Curved Hohmann Wide Hip Blade 12"	TWS 35778

OLDER GENERATION MIS SPINE ARTICULATING ARM

REF	ITEM DESCRIPTION	Code #
B	MIS Spine Articulating Arm	TWS 35784



COBRA BLADES (CURRENT)

REF	ITEM DESCRIPTION	Code #
T	Cobra Hip Blade 11"	TWS 35779
	Curved Cobra Hip Blade 12 1/2"	TWS 35780

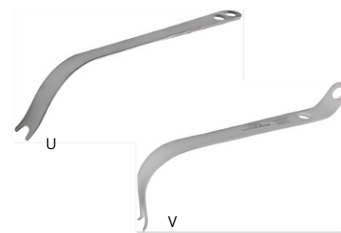

DUAL PRONG BLADES (CURRENT)

REF	ITEM DESCRIPTION	Code #
U	Dual Prong Hip Blade 11"	TWS 35781
V	Curved Dual Prong Hip Blade 12"	TWS 35782



MIS SPINE ARTICULATING ARM (CURRENT)

REF	ITEM DESCRIPTION	Code #
A	MIS Spine Articulating Arm	TWS 35783



FEMORAL NECK ELEVATOR (CURRENT)

ITEM DESCRIPTION	Code #
Femoral Neck Elevator 14"	



MIS SPINE FRAME RACKS (CURRENT)

REF	ITEM DESCRIPTION	Code #
C	MIS Spine Frame Rack 200mm (7 7/8")	TWS 35785
	MIS Spine Frame Rack 150mm (5 7/8")	TWS 35786
	MIS Spine Frame Rack 250mm (9 7/8")	TWS 35787

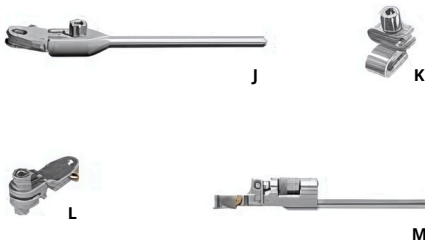

MIS SPINE FRAME ATTACHMENTS (CURRENT)

REF	ITEM DESCRIPTION	Code #
J	S-Lock Quick Angle Handle 6"	TWS 35794
K	1/4" Side Clip x 1/4" Slide with Thumb Screw	TWS 35795
L	S-Lock Interchangeable Head with 1/4" Scissor	TWS 35796

OLDER GEN. MIS SPINE FRAME ATTACHMENT

REF	ITEM DESCRIPTION	Code #
M	S-Lock Angling Handle 6"	TWS 35797



MIS PLA SEQUENTIAL DILATORS (CURRENT)

REF	ITEM DESCRIPTION	Code #
O	Dilator #1 - 7mm (1/4")	TWS 35805
P	Dilator #2 - 12mm (1/2")	TWS 35806
Q	Dilator #3 - 17mm (3/4")	TWS 35807
R	Dilator #4 - 21mm (7/8")	TWS 35808

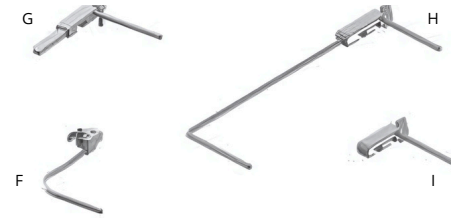

MIS SPINE FRAME ADD-ONS (CURRENT)

REF	ITEM DESCRIPTION	Code #
F	MIS Spine Frame U-Bar Add-On	TWS 35790
G	MIS Spine Frame L-Bar Add-On	TWS 35791

OLDER GENERATION MIS SPINE FRAME ADD-ONS

REF	ITEM DESCRIPTION	Code #
H	MIS Spine Frame U-Bar Add-On	TWS 35792
I	MIS Spine Frame L-Bar Add-On	TWS 35793

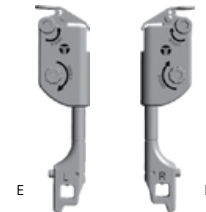

MIS SPINE FRAME ARMS (CURRENT)

REF	ITEM DESCRIPTION	Code #
D	MIS Spine Frame Right Arm	TWS 35788
E	MIS Spine Frame Left Arm	TWS 35789

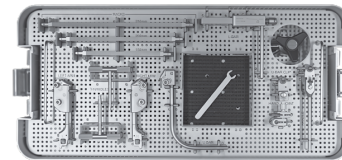

MIS PLA® INSTRUMENT TRAYS (CURRENT)

REF	ITEM DESCRIPTION	Code #
	MIS Spine Lid	TWS 35798
N	MIS Spine Tray	TWS 35799
	MIS Spine Bottom	TWS 35800
	PLA Lid	TWS 35801
	PLA Tray	TWS 35802
	PLA Dilator Tray	TWS 35803
	PLA Bottom	TWS 35804



CAUDAL / CEPHALAD BLADES

ITEM DESCRIPTION	LEFT Code #
Radiolucent R 22mm x 40mm (7/8" x 1 1/2")	TWS 35801
Radiolucent L 22mm x 40mm (7/8" x 1 1/2")	TWS 35809
Radiolucent R 22mm x 50mm (7/8" x 2")	TWS 35810
Radiolucent L 22mm x 50mm (7/8" x 2")	TWS 35811
Radiolucent R 22mm x 60mm (7/8" x 2 3/8")	TWS 35812
Radiolucent L 22mm x 60mm (7/8" x 2 3/8")	TWS 35813
Radiolucent R 22mm x 70mm (7/8" x 2 3/4")	TWS 35814
Radiolucent L 22mm x 70mm (7/8" x 2 3/4")	TWS 35815
Radiolucent R 22mm x 80mm (7/8" x 3 1/8")	TWS 35816
Radiolucent L 22mm x 80mm (7/8" x 3 1/8")	TWS 35817
Radiolucent R 22mm x 90mm (7/8" x 3 1/2")	TWS 35818
Radiolucent L 22mm x 90mm (7/8" x 3 1/2")	TWS 35819
Radiolucent R 22mm x 100mm (7/8" x 4")	TWS 35820
Radiolucent L 22mm x 100mm (7/8" x 4")	TWS 35821
Radiolucent R 22mm x 110mm (7/8" x 4 3/8")	TWS 35822
Radiolucent L 22mm x 110mm (7/8" x 4 3/8")	TWS 35823
Radiolucent R 22mm x 120mm (7/8" x 4 3/4")	TWS 35824
Radiolucent L 22mm x 120mm (7/8" x 4 3/4")	TWS 35825



MEDIAL / LATERAL BLADES W/LIP

ITEM DESCRIPTION	Code #
Radiolucent 13.5mm x 40mm (1/2" x 1 1/2")	TWS 35826
Radiolucent 13.5mm x 50mm (1/2" x 2")	TWS 35827
Radiolucent 13.5mm x 60mm (1/2" x 2 3/8")	TWS 35828
Radiolucent 13.5mm x 70mm (1/2" x 2 3/4")	TWS 35829
Radiolucent 13.5mm x 80mm (1/2" x 3 1/8")	TWS 35830
Radiolucent 13.5mm x 90mm (1/2" x 3 1/2")	TWS 35831
Radiolucent 13.5mm x 100mm (1/2" x 4")	TWS 35832
Radiolucent 13.5mm x 110mm (1/2" x 4 3/8")	TWS 35833
Radiolucent 13.5mm x 120mm (1/2" x 4 3/4")	TWS 35834

MEDIAL / LATERAL BLADES W/FINE TEETH

ITEM DESCRIPTION	Code #
Radiolucent 13.5mm x 40mm (1/2" x 1 1/2")	TWS 35835
Radiolucent 13.5mm x 50mm (1/2" x 2")	TWS 35836
Radiolucent 13.5mm x 60mm (1/2" x 2 3/8")	TWS 35837
Radiolucent 13.5mm x 70mm (1/2" x 2 3/4")	TWS 35838
Radiolucent 13.5mm x 80mm (1/2" x 3 1/8")	TWS 35839
Radiolucent 13.5mm x 90mm (1/2" x 3 1/2")	TWS 35840
Radiolucent 13.5mm x 100mm (1/2" x 4")	TWS 35841
Radiolucent 13.5mm x 110mm (1/2" x 4 3/8")	TWS 35842
Radiolucent 13.5mm x 120mm (1/2" x 4 3/4")	TWS 35843

**HOOK BLADES**

ITEM DESCRIPTION	Code #
40mm (1 ½")	TWS 35844
50mm (2")	TWS 35845
60mm (2 ¾")	TWS 35846
70mm (2 ¾")	TWS 35847
80mm (3 ⅛")	TWS 35848
90mm (3 ½")	TWS 35849
100mm (4")	TWS 35850
110mm (4 ⅜")	TWS 35851
120mm (4 ¾")	TWS 35852

CENTRAL CERVICAL ACCESS (CCA)

UNIQUE SYSTEM COMPONENTS

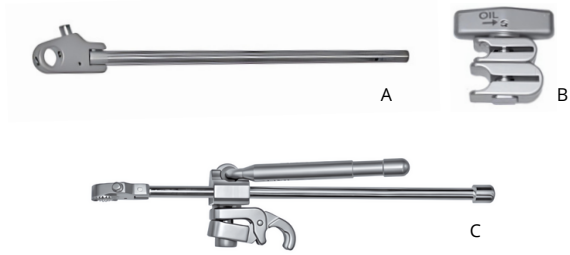

CCA HANDLES + CLIP-CLIP JOINT (CURRENT)

REF	ITEM DESCRIPTION	Code #
A	S-Lock Hinged Handle 8" (Clip-Clip Joint Required for use)	TWS 35853
B	Clip-Clip Joint 3/8" x 1/4"	TWS 35854
C	S-Lock Clip-On Hinged Handle 8" (to use CCA Bone Lever Blades with 1/2" frame components)	TWS 35855



MANIPULATOR HANDLE (CURRENT)

ITEM DESCRIPTION	Code #
Manipulator Handle	TWS 35861



TOWEL CLIP MICRO-ADJUSTABLE (CURRENT)

ITEM DESCRIPTION	Code #
Towel Clip Micro-Adjustable	TWS 35862



Interchange

SALDANHA ARCHED BLADES (CURRENT)

REF	ITEM DESCRIPTION	Code #
E	76mm x 140mm (3" x 5 1/2")	TWS 35865



CCA BONE LEVER BLADES (CURRENT)

ITEM DESCRIPTION	Code #
Bone Lever 14mm x 40mm (1/2" x 1 1/2")	TWS 35856
Bone Lever 14mm x 50mm (1/2" x 2")	TWS 35857
Bone Lever 14mm x 60mm (1/2" x 2 3/8")	TWS 35858
Bone Lever 14mm x 70mm (1/2" x 2 3/4")	TWS 35859
Bone Lever 14mm x 80mm (1/2" x 3 1/8")	TWS 35860

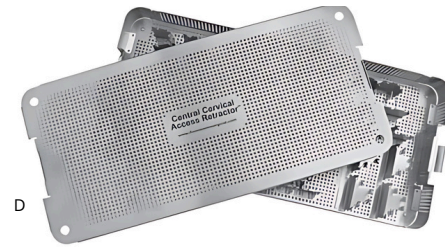

CCA INSTRUMENT TRAYS (CURRENT)

REF	ITEM DESCRIPTION	Code #
	CCA Blades	TWS 35863
	CCA Frame	TWS 35864

BODY CONTOURING

UNIQUE SYSTEM COMPONENTS

S lock

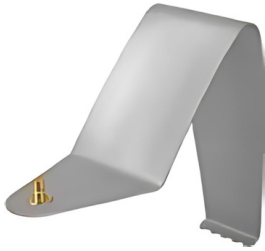

TUMMY TUCK BLADES (CURRENT)

REF	ITEM DESCRIPTION	Code #
SO	76mm x 140mm (3" x 5 1/2")	TWS 35866
SO	102mm x 140mm (4" x 5 1/2")	TWS 35867

Interchange

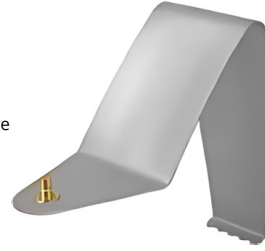

TUMMY TUCK BLADES (CURRENT)

REF	ITEM DESCRIPTION	Code #
INT	76mm x 140mm (3" x 5 1/2")	TWS 35868
INT	102mm x 140mm (4" x 5 1/2")	TWS 35869

Interchange



CAT'S PAW BLADES (CURRENT)

REF	ITEM DESCRIPTION	Code #
INT	6mm x 38mm (1/4" x 1 1/2")	TWS 35871

S-lock



CAT'S PAW BLADES (CURRENT)

REF	ITEM DESCRIPTION	Code #
SO	6mm x 38mm (1/4" x 1 1/2")	TWS 35870

Interchange



TOWEL CLIP HOOKS (CURRENT)

REF	ITEM DESCRIPTION	Code #
INT	45mm x 64mm (1 3/4" x 2 1/2")	TWS 35873

S-lock



TOWEL CLIP HOOKS (CURRENT)

REF	ITEM DESCRIPTION	Code #
SO	45mm x 64mm (1 3/4" x 2 1/2")	TWS 35872

PECTUSASSIST™ + BRAIN RETRACTOR SYSTEMS

ADDITIONAL SPECIALTY COMPONENTS



PECTUSASSIST™

ITEM DESCRIPTION	Code #
PectusAssist™	TWS 35875

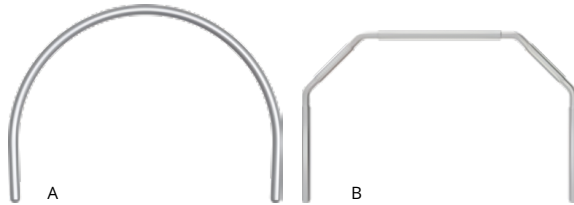

BRAIN FRAMES

REF	ITEM DESCRIPTION	Code #
A	C-Frame 13 ½" U-	TWS 35888
B	Frame 10" x 15 ½"	TWS 35889



BLADE HOLDERS

ITEM DESCRIPTION	Code #
Fix Holder Clip-On Screwdown	TWS 35886



BRAIN RAIL EXTENDER

ITEM DESCRIPTION	Code #
Rail Extender 15" with Jog	TWS 35887

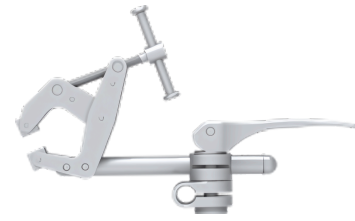

SKULL CLAMP MOUNT

ITEM DESCRIPTION	Code #
Skull Clamp Mount with Cam Joint	TWS 35874



BRAIN RETRACTOR BLADES

ITEM DESCRIPTION	Code #
Brain Retractor 6mm x 102mm	TWS 35876
Brain Retractor 9mm x 102mm	TWS 35877
Brain Retractor 16mm x 102mm	TWS 35878
Brain Retractor 19mm x 102mm	TWS 35879
Brain Retractor 25mm x 102mm	TWS 35880



BRAIN RETRACTOR BLADES – MALLEABLE

ITEM DESCRIPTION	Code #
Malleable Tapered Blade ¾" x ¾"	TWS 35881
Malleable Tapered Blade 5/32" x 5/8"	TWS 35882
Malleable Tapered Blade 1/8" x 1/2"	TWS 35883
Malleable Tapered Blade 3/32" x 3/8"	TWS 35884
Malleable Tapered Blade 1/16" x 1/2"	TWS 35885



TW
Surgical

Treasure Wright (U.K.) Ltd.

**Address: 128-160 , City Road,
London EC1V 2NX. United Kingdom**

www.twrightmedical.com

info@twrightmedical.com



TW Surgical



**UK
CA CE**