



TW
Surgical

LAPAROSCOPY



**UK
CA** **CE**



TW Surgical

Treasure Wright (U.K.) Ltd.



www.twrightmedical.com



info@twrightmedical.com

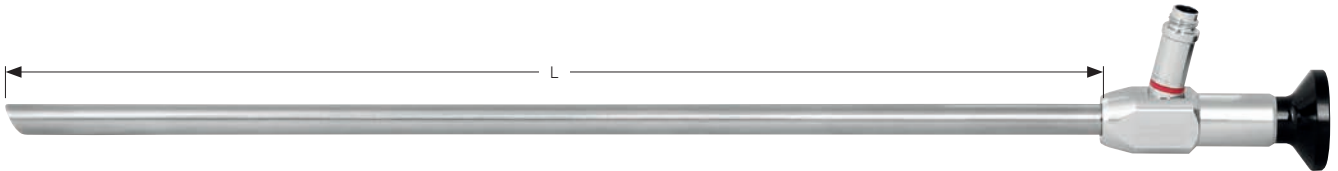

HD LAP

Length	Ø	0°			30°		45°	
300,0 mm	2,0 mm	TWS 29721	■	TWS 29727	■			
300,0 mm	3,0 mm	TWS 29722	■	TWS 29728	■			
240,0 mm	5,0 mm	TWS 29723	■	TWS 29729	■			
300,0 mm	5,0 mm	TWS 29724	■	TWS 29730	■			
339,0 mm	10,0 mm	TWS 29725	■					
341,0 mm	10,0 mm			TWS 29731	■	TWS 29732	■	
425,0 mm	10,0 mm	TWS 29726 XL	■	TWS 29733 XL	■	TWS 29734 XL	■	

4K
ULTRAHD



4K LAP

Length	Ø	0°			30°		45°	
300,0 mm	5,5 mm	TWS 29735 UHD		TWS 29739 UHD		TWS 29743 UHD		
424,0 mm	5,5 mm	TWS 29736 UHDXL		TWS 29740 UHDXL		TWS 29744 UHDXL		
330,0 mm	10,0 mm	TWS 29737 UHD		TWS 29741 UHD		TWS 29745 UHD		
450,0 mm	10,0 mm	TWS 29738 UHDXL		TWS 29742 UHDXL		TWS 29746 UHDXL		



3-Shaft Endoscope

XL = for adipose patients

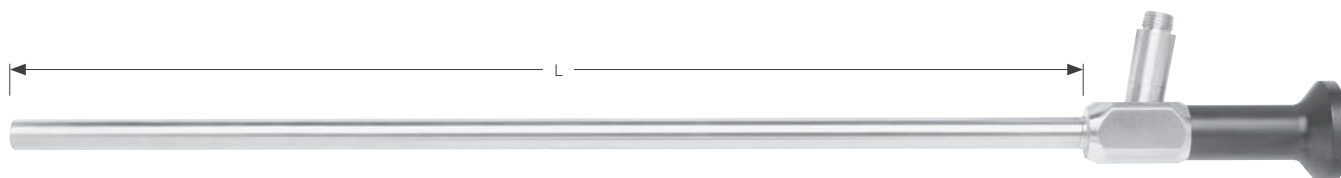
4K
ULTRAHD



4K VEQTRON ICG/NIR

Length	Ø	0°	30°
			
300.0 mm	5.5 mm	TWS 29747 NIR	TWS 29749 NIR
330.0 mm	10.0 mm	TWS 29748 NIR	TWS 29750 NIR

3-Shaft Endoscope



TWS 29751 Ø 6,1 mm

Adapter for OP-Laparoscope

HD LAP

Länge
Length

Ø

0°

266,3 mm

10,0 mm

TWS 29752



OP-Laparoscope, 90° double angled, instrument channel
Ø 6.0 mm, including adapter (72-423-01)



TWS 29753 Ø 6,1 mm

Adapter for OP-Laparoscope

HD LAP

Length

Ø

0°

266,3 mm

10,0 mm

TWS 29754



OP-Laparoscope, 45° angled, instrument channel
Ø 6.0 mm, including adapter (72-423-01)



VERESS

Working length Ø 2,0 mm

100 mm	TWS 29757
120 mm	TWS 29758
130 mm	TWS 29759
150 mm	TWS 29760
180 mm	TWS 29761
200 mm	TWS 29762

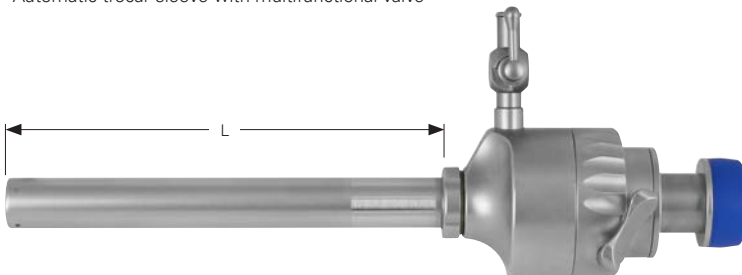

Automatic trocar sleeve with multifunctional valve



Complete with sleeve and conical trocar



Complete with sleeve and pyramidal trocar

Working length	Ø	Sleeve, only	Complete	Complete
			A 	B 
70,0 mm	3,5 mm	TWS 29763	TWS 29774	TWS 29784
92,0 mm	5,0 mm	TWS 29764	TWS 29775	TWS 29785
95,0 mm	5,5 mm	TWS 29745	TWS 29776	TWS 29786
150,0 mm	5,5 mm	TWS 29766 XL	TWS 29776 XL	TWS 29787 XL
95,0 mm	7,0 mm	TWS 29767	TWS 29777	TWS 29788
97,0 mm	10,0 mm	TWS 29768	TWS 29778	TWS 29789
101,0 mm	11,0 mm	TWS 29769	TWS 29779	TWS 29780
150,0 mm	11,0 mm	TWS 29770 XL	TWS 29780 XL	TWS 29781 XL
98,0 mm	12,5 mm	TWS 29771	TWS 29781	TWS 29782
150,0 mm	12,5 mm	TWS 29772 XL	TWS 29782 XL	TWS 29784 XL
102,0 mm	13,0 mm	TWS 29773	TWS 29783	TWS 29783

XL = for adipose patients

Automatic trocar sleeves

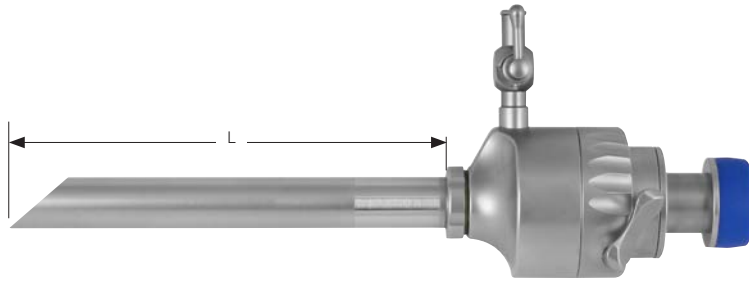

Automatic trocar sleeve with multifunctional valve



Complete with sleeve and conical trocar



Complete with sleeve and pyramidal trocar

Working length	Ø	Sleeve, only	Complete	
			A 	B 
109,9 mm	15,0 mm	TWS 29785	TWS 29787	TWS 29789
118,7 mm	20,0 mm	TWS 29786	TWS 29788	TWS 29790

Automatic trocar sleeve with multifunctional valve

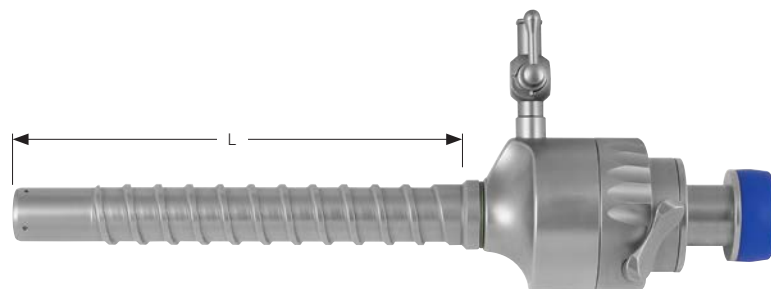

With metal shaft tube, threaded



With plastic shaft tube (X-Ray translucent), smooth



With plastic shaft tube (X-Ray translucent), threaded

Working length	Ø	Sleeve, only		
		A	B	C
95,0 mm	5,5 mm	TWS 29791	TWS 29794	TWS 29797
101,0 mm	11,0 mm	TWS 29793	TWS 29795	TWS 29798
98,0 mm	12,5 mm	TWS 29792	TWS 29796	TWS 29799

COMPACT trocar sleeves with silicone valve

COMPACT trocar sleeve with metal shaft tube, smooth



Complete with sleeve and conical trocar



Complete with sleeve and pyramidal trocar

Working length	Ø	Sleeve, only	Complete	Complete
			A	B
95,0 mm	5,5 mm	TWS 29800	TWS 29809	TWS 29819
150,0 mm	5,5 mm	TWS 29801 XL	TWS 29810 XL	TWS 29818 XL
95,0 mm	7,0 mm	TWS 29802	TWS 29811	TWS 29819
105,0 mm	8,0 mm	TWS 29803	TWS 29812	TWS 29820
97,0 mm	10,0 mm	TWS 29804	TWS 29813	TWS 29821
101,0 mm	11,0 mm	TWS 29805	TWS 29814	TWS 29822
150,0 mm	11,0 mm	TWS 29806 XL	TWS 29815 XL	TWS 29823 XL
98,0 mm	12,5 mm	TWS 29807	TWS 29816	TWS 29824
100,0 mm	15,0 mm	TWS 29808	TWS 29817	TWS 29825

XL = for adipose patients

COMPACT trocar sleeve with metal shaft tube, threaded

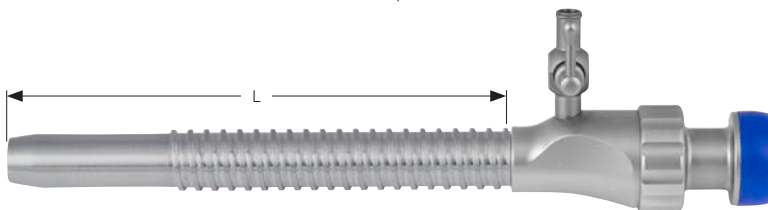

Spare silicone valve for COMPACT trocar sleeves



Working length	Ø	Sleeve, only
95,0 mm	5,5 mm	TWS 29826
101,0 mm	11,0 mm	TWS 29827
98,0 mm	12,5 mm	

Ø	Trocar sleeves
5,5 - 12,5 mm	TWS 29828
15,0 mm	TWS 29829

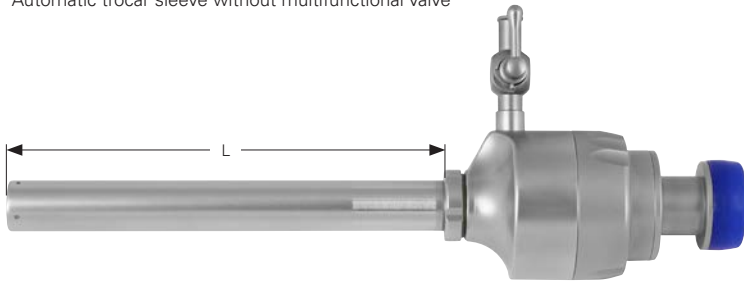

Automatic trocar sleeve without multifunctional valve



Complete with sleeve and conical trocar



Complete with sleeve and pyramidal trocar

Working length	Ø	Sleeve, only	Complete	
			A 	B 
70,0 mm	3,5 mm	TWS 29830	TWS 29835	TWS 29840
95,0 mm	5,5 mm	TWS 29831	TWS 29836	TWS 29841
95,0 mm	7,0 mm	TWS 29832	TWS 29837	TWS 29842
101,0 mm	11,0 mm	TWS 29833	TWS 29838	TWS 29843
98,0 mm	12,5 mm	TWS 29834	TWS 29839	TWS 29844



TWS 29846

Spare sealing caps

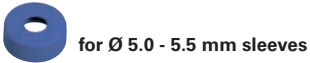

TWS 29847

Spare sealing caps



TWS 29850

Spare sealing caps



TWS 29851

Spare sealing caps



TWS 29845

Spare sealing caps



TWS 29848

Spare sealing caps



TWS 29849

Spare sealing caps



TWS 29852

Spare sealing caps



TWS 29853

Spare sealing caps



TWS 29854

Spare inner sealing

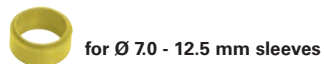

TWS 29855

Spare inner sealing

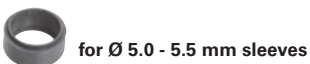

TWS 29857

Spare inner sealing



TWS 29856

Spare inner sealing



TWS 29858

O-Rings for automatic trocar sleeves

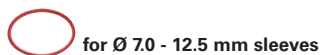

TWS 29859

O-Rings for automatic trocar sleeves

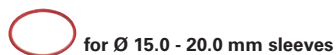

TWS 29860

O-Rings for automatic trocar sleeves

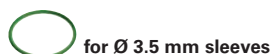

TWS 29861

O-Rings for tubes of automatic trocar sleeves



TWS 29862

O-Rings for tubes of automatic trocar sleeves



TWS 29863

O-Rings for tubes of automatic trocar sleeves



TWS 29864

O-Rings for tubes of automatic trocar sleeves



TWS 29865

O-Rings for tubes of automatic trocar sleeves

Trocars for automatic trocar sleeve



TW Surgical



Trocar, conical

Trocar, pyramidal

Trocar, blunt

Ø



3,5 mm	TWS 29866	TWS 29880	TWS 29894
5,0 mm	TWS 29867	TWS 29881	TWS 29895
5,5 mm	TWS 29868	TWS 29882	TWS 29896
5,5 mm	TWS 29869 XL	TWS 29883 XL	TWS 29897 XL
7,0 mm	TWS 29870	TWS 29884	
8,0 mm	TWS 29871	TWS 29885	
10,0 mm	TWS 29872	TWS 29886	TWS 29898
11,0 mm	TWS 29873	TWS 29887	TWS 29899
11,0 mm	TWS 29874 XL	TWS 29888 XL	TWS 29900 XL
12,5 mm	TWS 29875	TWS 29889	TWS 29901
12,5 mm	TWS 29876 XL	TWS 29890 XL	
13,0 mm	TWS 29877	TWS 29891	
15,0 mm	TWS 29878	TWS 29892	
20,0 mm	TWS 29879	TWS 29893	

XL = for adipose patients

Treasure Wright (U.K.) Ltd.

128-160 City Road, London, EC1V 2NX, United Kingdom
info@twrightmedical.com

Safety trocar with automatic locking mechanism, detachable



Working length	Ø	Pyramidal tip	Halfmoon tip	Knife tip
160,0 mm	5,5 mm	TWS 29902	TWS 29910	TWS 29915
215,0 mm	5,5 mm	TWS 29903 XL		
171,0 mm	8,0 mm	TWS 29904	TWS 29911	
171,0 mm	11,0 mm	TWS 29905	TWS 29912	TWS 29916
220,0 mm	11,0 mm	TWS 29906 XL		
171,0 mm	12,5 mm	TWS 29907	TWS 29913	TWS 29917
223,0 mm	12,5 mm	TWS 29908 XL		
170,0 mm	13,0 mm	TWS 29909	TWS 29914	TWS 29918

XL = for adipose patients



TWS 29919 Ø 3,5 mm

Protection trocar, blunt, WL 132 mm

Protection trocar, halfmoon tip

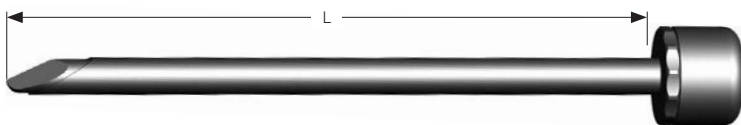

Working length	Ø	V-shape tip	oblique
160,0 mm	5,5 mm	TWS 29920	TWS 29924
171,0 mm	8,0 mm	TWS 29921	
171,0 mm	11,0 mm	TWS 29922	TWS 29925
171,0 mm	12,5 mm	TWS 29923	TWS 29926

Spare shaft tubes for automatic trocar sleeves



Metal shaft tube, smooth



Plastic shaft tube (X-Ray translucent), smooth



Metal shaft tube, threaded



Plastic shaft tube (X-Ray translucent), threaded

Working length	Ø	Smooth	Threaded	Smooth	Threaded
		A	B	C	D
70,0 mm	3,5 mm	TWS 29927			
95,0 mm	5,5 mm	TWS 29928	TWS 29936	TWS 29939	TWS 29942
150,0 mm	5,5 mm	TWS 29929 XL			
101,0 mm	11,0 mm	TWS 29930	TWS 29937	TWS 29940	TWS 29943
150,0 mm	11,0 mm	TWS 29931 XL			
98,0 mm	12,5 mm	TWS 29932	TWS 29938	TWS 29941	TWS 29944
150,0 mm	12,5 mm	TWS 29933 XL			
109,9 mm	15,0 mm	TWS 29934			
118,7 mm	20,0 mm	TWS 29935			

XL = for adipose patients

Cone, adjustable, with sutureholder



HASSON

Ø	Item number
5,5 mm	TWS 29945
10,0 mm	TWS 29946
11,0 mm	TWS 29947
12,5 mm	TWS 29948

Cone with thread



HASSON

Ø	Item number
11,0 mm	TWS 29949

Spare sealing caps for Hasson cone



Ø	Item number
5,5 mm	TWS 29950
10,0 mm	TWS 29951
11,0 mm	TWS 29952
12,5 mm	TWS 29953

Accessories for trocar sleeves

Distance holder with fixation thread

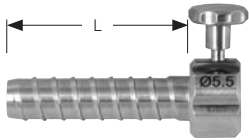

Working length	Ø	Item number
35,0 mm	5,5 mm	TWS 29954
35,0 mm	10,0 mm	TWS 29955
35,0 mm	11,0 mm	TWS 29956
35,0 mm	12,5 mm	TWS 29957

Slide reducer for trocar sleeves



Outer Ø	Inner Ø	Item number
10,0	5,5 mm	TWS 29958
11,0	5,5 mm	TWS 29959
12,5	5,5 mm	TWS 29960
13,0	5,5 mm	TWS 29961
12,5	10,0 mm	TWS 29962
13,0	10,0 mm	TWS 29963

Reducer for trocar sleeves



Outer Ø	Inner Ø	Item number
10,0	5,0 mm	TWS 29964
11,0	5,5 mm	TWS 29965
12,5	5,5 mm	TWS 29966
15,0	5,5 mm	TWS 29967
15,0	11,0 mm	TWS 29968

Reducer with silicone holder for trocar sleeves



Outer Ø	Inner Ø	Item number
10,0	5,5 mm	TWS 29969
11,0	5,5 mm	TWS 29970
12,5	5,5 mm	TWS 29971
12,5	10,0 mm	TWS 29972
8,0	5,5 mm	TWS 29973
11,0	8,0 mm	TWS 29974
12,5	8,0 mm	TWS 29975

Reducing sleeve for trocar sleeves



Working length	Outer Ø	Inner	Item number
180,0 mm	5,0	4,0 mm	TWS 29976
180,0 mm	10,0	5,5 mm	TWS 29977
180,0 mm	11,0	5,5 mm	TWS 29978
180,0 mm	12,5	5,5 mm	TWS 29979
180,0 mm	12,5	10,0 mm	TWS 29980
190,0 mm	15,0	5,5 mm	TWS 29981
190,0 mm	15,0	10,0 mm	TWS 29982
190,0 mm	20,0	10,0 mm	TWS 29983
190,0 mm	20,0	15,0 mm	TWS 29984

Dilation set

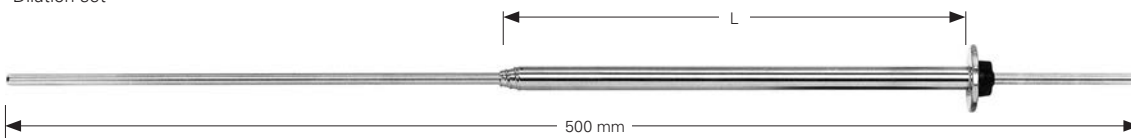

Working length from to

Working length	from	to	Ø	Item number
180,0 mm	5,0	10,0 mm		TWS 29985
180,0 mm	5,0	11,0 mm		TWS 29986
190,0 mm	10,0	15,0 mm		TWS 29987
190,0 mm	10,0	20,0 mm		TWS 29988

TWS 29989 Ø 5,0 mm
TWS 29990 Ø 10,0 mm

Guide rod, only

Palpation probes, graduated



Working length	Ø	Item number
250,0 mm	2,8 mm	TWS 29991
330,0 mm	2,8 mm	TWS 29992
330,0 mm	5,0 mm	TWS 29993
360,0 mm	5,0 mm	TWS 29996
450,0 mm	5,0 mm	TWS 29995

needle with LUER-LOCK connection, curved

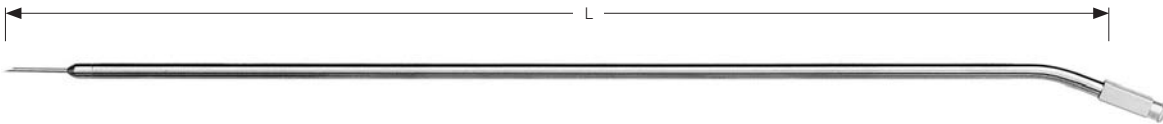

Working length	Needle		Item number
	Ø	Ø	
450,0 mm	5,0 mm	0,7 mm	TWS 29994

Suction and irrigation cannulas

Punction- and injection cannula with small LUER-LOCK connection, Needle length 20 mm



Needle

Working length	Ø	Ø	Item number
250,0 mm	2,8 mm	1,2 mm 18,0 G	TWS 29997
330,0 mm	2,8 mm	1,2 mm 18,0 G	TWS 29998
330,0 mm	5,0 mm	0,7 mm 22,0 G	TWS 29999
450,0 mm	5,0 mm	0,7 mm 22,0 G	TWS 30000
330,0 mm	5,0 mm	0,9 mm 20,0 G	TWS 30001
450,0 mm	5,0 mm	0,9 mm 20,0 G	TWS 30003
330,0 mm	5,0 mm	1,2 mm 18,0 G	TWS 30002
450,0 mm	5,0 mm	1,2 mm 18,0 G	TWS 30004
330,0 mm	5,0 mm	1,4 mm 17,0 G	TWS 30005
450,0 mm	5,0 mm	1,4 mm 17,0 G	TWS 30006
330,0 mm	5,0 mm	1,5 mm 16,5 G	TWS 30007
450,0 mm	5,0 mm	1,5 mm 16,5 G	TWS 30008
330,0 mm	5,0 mm	1,8 mm 15,0 G	TWS 30009
450,0 mm	5,0 mm	1,8 mm 15,0 G	TWS 30010



TWS 30011 Ø 5,0 x 330 mm

Suction and irrigation tube, 4 holes, small LUER-LOCK connection



TWS 30013

Two-way-stopcock for contrast medium, small LUER-LOCK connection

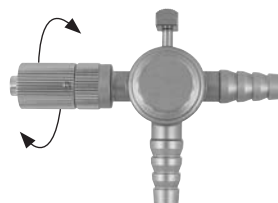

TWS 30012

Suction and irrigation handle, sliding valve, rotatable, small LUER-LOCK connection

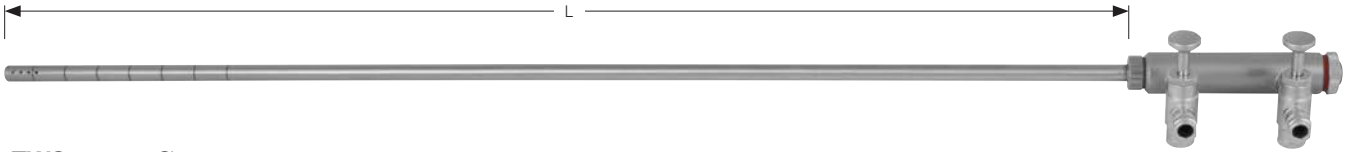

TWS 30014 Ø 5,0 x 350 mm

Suction and irrigation cannula, with round handle, 2 trumpet valves, LUER-LOCK connection, **with laser guide**

TWS 30015 Ø 5,0 x 350 mm

Suction and irrigation cannula, with round handle, 2 trumpet valves, LUER-LOCK connection



TWS 30016

O-Rings for suction and irrigation tubes



TWS 30017

Laser guide with LUER-LOCK connection



TWS 30018 Ø 2,8 x 250 mm

TWS 30019 Ø 2,8 x 330 mm

Suction and irrigation cannula, with square handle, 2 trumpet valves, LUER-LOCK connection



TWS 30020 Ø 5,0 x 330 mm

TWS 30021 Ø 5,0 x 450 mm

Suction and irrigation cannula, graduated, 16 holes, LUER-LOCK connection with stopcock

Suction and irrigation cannulas, thread M 6 x 0.5

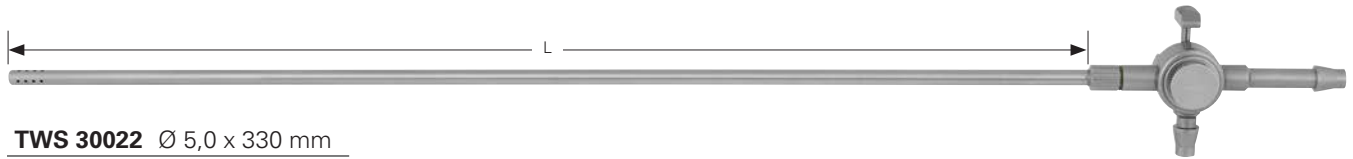

TWS 30022 Ø 5,0 x 330 mm

Suction and irrigation cannula, roundhole sucker, 16 holes, complete with sliding valve



TWS 30023

Suction and irrigation handle, sliding valve, tube connection



TWS 30024

O-Rings for suction

Suction and irrigation tubes with round holes

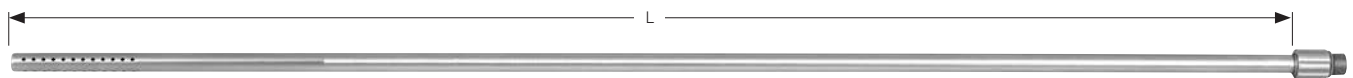

Working length	Ø	Holes	Item number
250,0 mm	2,8 mm	8	TWS 30025
330,0 mm	2,8 mm	8	TWS 30026
330,0 mm	5,0 mm	4	TWS 30027
327,5 mm	5,0 mm	16	TWS 30028
330,0 mm	10,0 mm	24	TWS 30029



TWS 30030 Ø 5,0 x 330 mm

TWS 30031 Ø 5,0 x 500 mm

Suction and irrigation tube, blunt with round holes, 48 holes

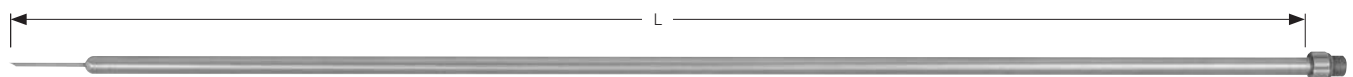

TWS 30032 Ø 5,0 x 330 mm

Punction needle sucker, needle Ø 1.2 mm



TWS 30033



TWS 30034

Suction and irrigation handle, 2 trumpet valves, **large** tube connection („Suction“) and lateral LL tube connection („Irrigation“)

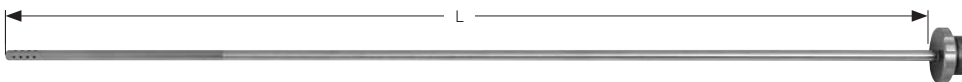

TWS 30035 Ø 3,5 x 240 mm

Suction and irrigation tube

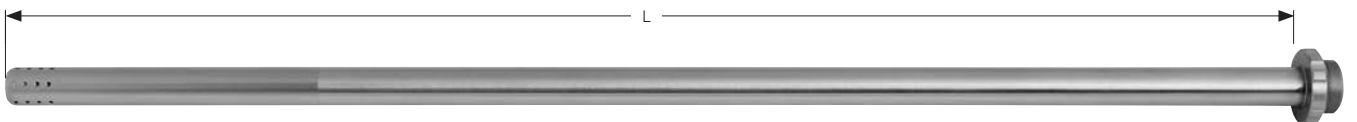

TWS 30036 Ø 5,0 x 330 mm

TWS 30037 XL Ø 5,0 x 450 mm

TWS 30038 Ø 10,0 x 330 mm

TWS 30039 XL Ø 10,0 x 450 mm

Suction and irrigation tube



TWS 30040

O-Rings for suction

Suction and irrigation cannulas, thread M 8 x 1



TWS 30041

Suction and irrigation handle, trumpet valve, combined LUER-LOCK / tube connector



TWS 30042

Suction and irrigation pistol handle, sliding valve, 2 combined LUER-LOCK / tube connectors

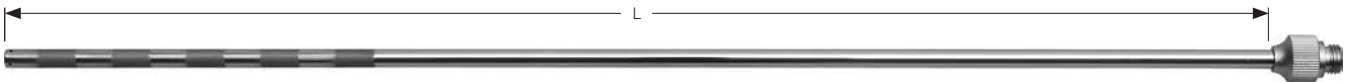

- TWS 30043** Ø 3,0 x 340 mm
- TWS 30045** Ø 5,0 x 340 mm
- TWS 30044** Ø 10,0 x 340 mm

Suction and irrigation tube, 4 holes

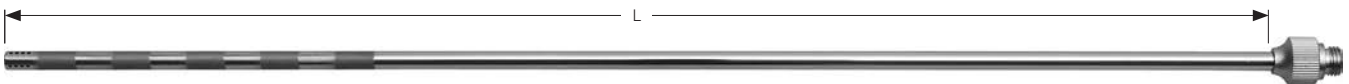

- TWS 30046** Ø 3,0 x 340 mm
- TWS 30047** Ø 5,0 x 340 mm
- TWS 30048** Ø 10,0 x 340 mm

Suction and irrigation tube, 16 holes

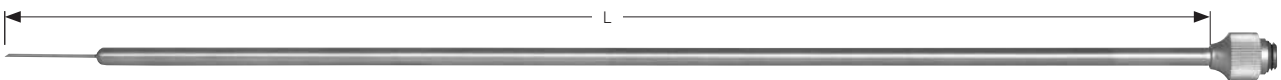

TWS 30049 Ø 5,0 x 330 mm

Punction needle sucker, needle Ø 1,5 mm



TWS 30050

Suction and irrigation pistol handle, 2-way sliding valve, 2 tube connectors, ergonomical handle design

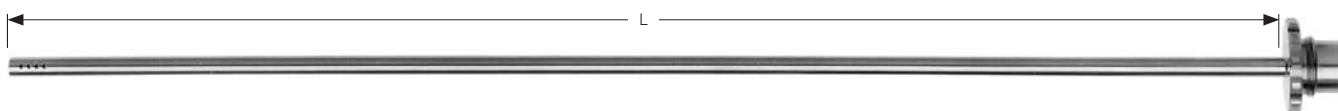

TWS 30051	Ø 3,0 x 330 mm
TWS 30052	Ø 5,0 x 330 mm
TWS 30053	Ø 10,0 x 330 mm
TWS 30054 XL	Ø 10,0 x 450 mm

Suction and irrigation tube

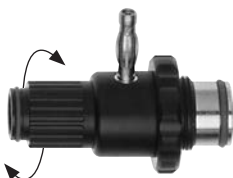

TWS 30055

Electrode adapter, 360° rotatable for Suction

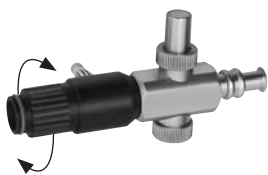

TWS 30056

Suction and irrigation handle, trumpet valve, combined LUER-LOCK / tube connector, rotatable adapter for exchangeable electrodes



TWS 30057

Suction and irrigation handle, sliding valve, combined LUER-LOCK / tube connector, rotatable adapter for exchangeable electrodes



TWS 30058 Ø 5,0 x 330 mm

Ball point electrode, LUER-LOCK connection



TWS 30059 Ø 5,0 x 330 mm

J-Hook electrode, LUER-LOCK connection



TWS 30060 Ø 5,0 x 330 mm

Hook electrode 90°, LUER-LOCK connection



TWS 30061 Ø 5,0 x 330 mm

Spatula electrode, LUER-LOCK connection



TWS 30062 Ø 5,0 x 330 mm

Needle electrode, LUER-LOCK connection

Monopolar suction electrodes with LUER-LOCK connection



Ø 5,0 mm

Length

Length

Version

330,0 mm

450,0 mm



Button tip electrode

TWS 30063

TWS 30071



J-Hook electrode

TWS 30064

TWS 30072



Hook electrode 90°

TWS 30065

TWS 30070



Spatula electrode

TWS 30066

TWS 30069



Needle electrode

TWS 30067

TWS 30068

Treasure Wright (U.K.) Ltd.

Monopolar suction electrodes with trumpet valve



Ø 5,0 mm

	Length	Length
Version	330,0 mm	450,0 mm
 Button tip electrode	TWS 30069	TWS 30070
 J-Hook electrode	TWS 30071	TWS 30075
 Hook electrode 90°	TWS 30072	TWS 30076
 Spatula electrode	TWS 30073	TWS 30077
 Needle electrode	TWS 30074	TWS 30078

Monopolar connecting cables with round plug



Plug instrument side

	Length	Item number
 Ø 4 mm	3,0 m	TWS 30079
	5,0 m	TWS 30080
 Ø 5 mm	3,0 m	TWS 30081
	5,0 m	TWS 30082
 Ø 8 mm	3,0 m	TWS 30083
	5,0 m	TWS 30084

with HF-connection



TWS 30085

without ratchet

with HF-connection



TWS 30086

with ratchet

with HF-connection



TWS 30087

with shiftable ratchet

! 360 mm length upon request



Total length

Ø 5,0 mm

Ø 10,0 mm

220 mm	TWS 30088	TWS 30092
330 mm	TWS 30089	TWS 30093
450 mm	TWS 30090	TWS 30091

insulated



73-205-99

High-pressure rinsing adapter with Luer-Lock connection, for rinsing of outer sheaths

! 360 mm length upon request



Total length

Ø 5,0 mm

Ø 10,0 mm

220 mm	TWS 30094 LL	TWS 30097 LL
330 mm	TWS 30096 LL	TWS 30098 LL
450 mm	TWS 30095 LL	TWS 30099 LL

insulated, with Luer-Lock rinsing channel



TWS 30100 Ø 5,0 mm
TWS 30101 Ø 10,0 mm

Screw cap black, for Laparoscopy sheaths



TWS 30102

without ratchet





TWS 30103

with
ratchet

Monopolar connecting cables with round plug



Plug instrument side

	Length	Item number
Ø 4 mm 	3,0 m	TWS 30104
	5,0 m	TWS 30105
Ø 5 mm 	3,0 m	TWS 30106
	5,0 m	TWS 30107
Ø 8 mm 	3,0 m	TWS 30108
	5,0 m	TWS 30109

Treasure Wright (U.K.) Ltd.

128-160 City Road, London, EC1V 2NX, United Kingdom
 info@twrightmedical.com

Monopolar Laparoscopy instruments, shaft Ø 3.0 mm



TW Surgical

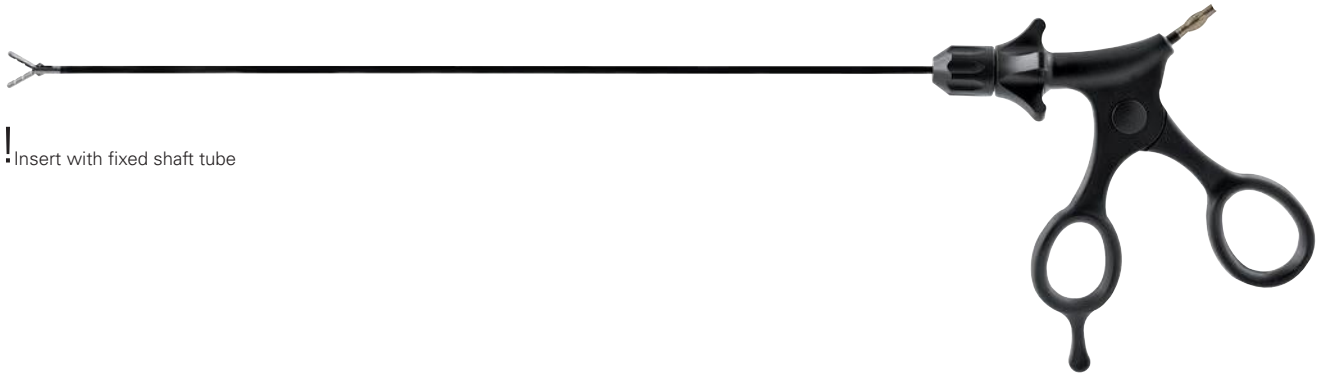











Insert with fixed shaft tube

rotatable, detachable with HF-connection

Ø 3,0 mm



Version	Length	Insert, only	without ratchet	with ratchet
	220 mm	TWS 30110	TWS 30114 C	
	330 mm	TWS 30112	TWS 30113 C	
	220 mm	TWS 30115	TWS 30119 C	
	330 mm	TWS 30116	TWS 30120 C	
	220 mm	TWS 30117	TWS 30121 C	
	330 mm	TWS 30118	TWS 30122 C	
	220 mm	TWS 30149	TWS 30123 C	
	330 mm	TWS 30150	TWS 30124 C	
	220 mm	TWS 30151	TWS 30125 C	TWS 30137 CR
	330 mm	TWS 30152	TWS 30126 C	TWS 30138 CR
	220 mm	TWS 30153	TWS 30127 C	TWS 30139 CR
	330 mm	TWS 30154	TWS 30128 C	TWS 30140 CR
	220 mm	TWS 30155	TWS 30129 C	TWS 30141 CR
	330 mm	TWS 30156	TWS 30130 C	TWS 30142 CR
	220 mm	TWS 30157	TWS 30131 C	TWS 30143 CR
	330 mm	TWS 30158	TWS 30132 C	TWS 30144 CR
	220 mm	TWS 30159	TWS 30133 C	TWS 30145 CR
	330 mm	TWS 30160	TWS 30134 C	TWS 30146 CR
	220 mm	TWS 30161	TWS 30135 C	TWS 30147 CR
	330 mm	TWS 30162	TWS 30136 C	TWS 30148 CR

Treasure Wright (U.K.) Ltd.

128-160 City Road, London, EC1V 2NX, United Kingdom
info@twrightmedical.com











! 360 mm length upon request

rotatable, detachable with HF-connection

Ø 5,0 mm



Version	Length	Insert, only	without ratchet	with ratchet
 METZENBAUM scissors, serrated, curved, blade length 11 mm	220 mm	TWS 30149	TWS 30152 C	
	330 mm	TWS 30150	TWS 30153 C	
	450 mm	TWS 30151	TWS 30154 C	
 METZENBAUM scissors, serrated, curved, blade length 15 mm	220 mm	TWS 30155	TWS 30158 C	
	330 mm	TWS 30156	TWS 30159 C	
	450 mm	TWS 30157	TWS 30160 C	
 METZENBAUM scissors, serrated, straight, blade length 11 mm	220 mm	TWS 30161	TWS 30164 C	
	330 mm	TWS 30162	TWS 30165 C	
	450 mm	TWS 30163	TWS 30166 C	
 METZENBAUM scissors, serrated, straight, blade length 15 mm	220 mm	TWS 30167	TWS 30170 C	
	330 mm	TWS 30168	TWS 30171 C	
	450 mm	TWS 30169	TWS 30172 C	
 Hook scissors, straight	220 mm	TWS 30173	TWS 30176 C	
	330 mm	TWS 30174	TWS 30177 C	
	450 mm	TWS 30175	TWS 30178 C	
 scissors, straight	220 mm	TWS 30179	TWS 30182 C	
	330 mm	TWS 30180	TWS 30183 C	
	450 mm	TWS 30181	TWS 30184 C	
 Micro scissors, curved	220 mm	73-306-22	73-306-22 C	
	330 mm	73-306-33	73-306-33 C	
	450 mm	73-306-45	73-306-45 C	
 Peritoneal scissors, serrated, straight	220 mm	TWS 30186	TWS 30189 C	
	330 mm	TWS 30187	TWS 30190 C	
	450 mm	TWS 30188	TWS 30191 C	
 Endo scissors, serrated, curved, blade length 17 mm	220 mm	TWS 30192	TWS 30195 C	
	330 mm	TWS 30193	TWS 30196 C	
	450 mm	TWS 30194	TWS 30197 C	

Monopolar Laparoscopy instruments, shaft Ø 5.0 mm



TW Surgical

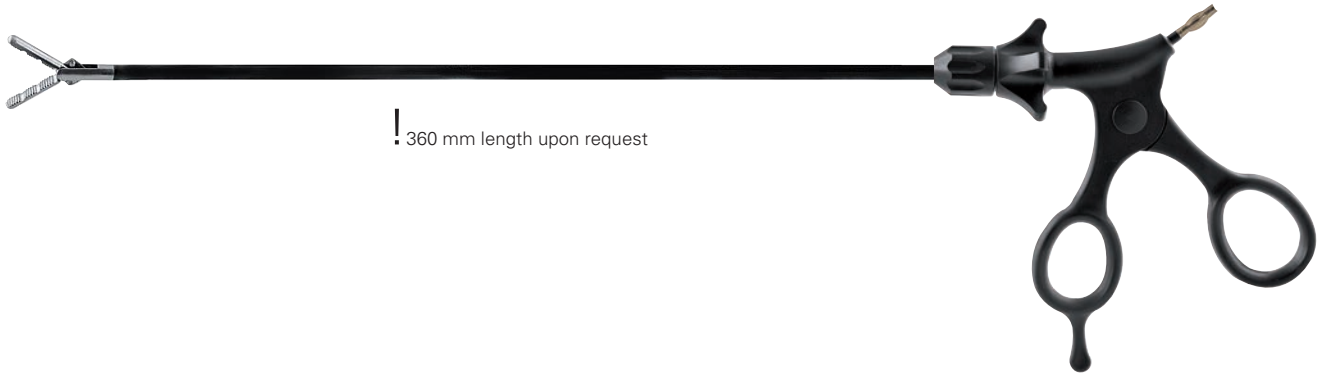









! 360 mm length upon request

rotatable, detachable with HF-connection

Ø 5,0 mm



Version	Length	Insert, only	without ratchet	with ratchet
 BLAKESLEY biopsy forceps	220 mm	TWS 30198	TWS 30201 C	
	330 mm	TWS 30199	TWS 30202 C	
	450 mm	TWS 30200	TWS 30203 C	
 Biopsy forceps, spoon oval	220 mm	TWS 30204	TWS 30207 C	
	330 mm	TWS 30205	TWS 30208 C	
	450 mm	TWS 30206	TWS 30209 C	
 Biopsy forceps, spoon oval with spike	220 mm	TWS 30210	TWS 30213 C	
	330 mm	TWS 30211	TWS 30214 C	
	450 mm	TWS 30212	TWS 30215 C	
 Biopsy forceps, spoon oval	220 mm	TWS 30216	TWS 30219 C	
	330 mm	TWS 30217	TWS 30220 C	
	450 mm	TWS 30218	TWS 30221 C	
 Biopsy forceps, spoon oval with spike	220 mm	TWS 30222	TWS 30225 C	
	330 mm	TWS 30223	TWS 30226 C	
	450 mm	TWS 30224	TWS 30227 C	
 Biopsy punch with basket, through cutting	220 mm	TWS 30228	TWS 30231 C	
	330 mm	TWS 30229	TWS 30232 C	
	450 mm	TWS 30230	TWS 30233 C	
 Alligator grasping forceps, spoon toothed	220 mm	TWS 30234	TWS 30237 C	
	330 mm	TWS 30235	TWS 30238 C	
	450 mm	TWS 30236	TWS 30239 C	
 FUNDUS grasping forceps	220 mm	TWS 30240	TWS 30243 C	TWS 30246 CR
	330 mm	TWS 30241	TWS 30244 C	TWS 30247 CR
	450 mm	TWS 30242	TWS 30245 C	TWS 30248 CR

Treasure Wright (U.K.) Ltd.

128-160 City Road, London, EC1V 2NX, United Kingdom
 info@twrightmedical.com

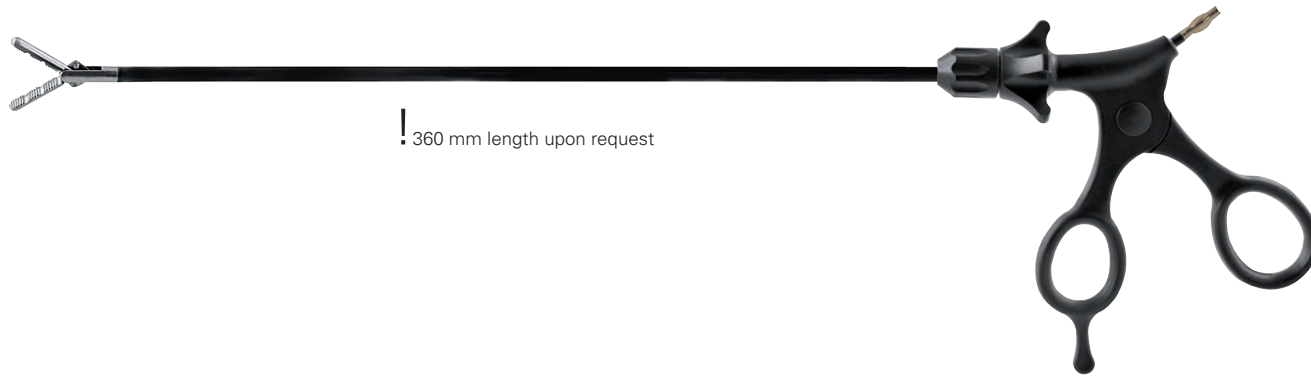









! 360 mm length upon request

rotatable, detachable with HF-connection

Ø 5,0 mm



Version	Length	Insert, only	without ratchet	with ratchet
 FUNDUS grasping forceps, fenestrated	220 mm	TWS 30249	TWS 30252 C	TWS 30255 CR
	330 mm	TWS 30250	TWS 30253 C	TWS 30256 CR
	450 mm	TWS 30251	TWS 30254 C	TWS 30257 CR
 TC grasping forceps, heavy pattern	220 mm	TWS 30258	TWS 30261 C	TWS 30264 CR
	330 mm	TWS 30259	TWS 30262 C	TWS 30265 CR
	450 mm	TWS 30260	TWS 30263 C	TWS 30266 CR
 Grasping & dissecting forceps, serrated	220 mm	TWS 30267	TWS 30270 C	TWS 30273 CR
	330 mm	TWS 30268	TWS 30271 C	TWS 30274 CR
	450 mm	TWS 30269	TWS 30272 C	TWS 30275 CR
 Dolphin grasping & dissecting forceps, serrated	220 mm	TWS 30276	TWS 30279 C	TWS 30282 CR
	330 mm	TWS 30277	TWS 30280 C	TWS 30283 CR
	450 mm	TWS 30278	TWS 30281 C	TWS 30284 CR
 DUCKBILL grasping & dissecting forceps, flat	220 mm	TWS 30285	TWS 30288 C	TWS 30291 CR
	330 mm	TWS 30286	TWS 30289 C	TWS 30292 CR
	450 mm	TWS 30287	TWS 30290 C	TWS 30293 CR
 Grasping & dissecting forceps, straight, serrated	220 mm	TWS 30294	TWS 30297 C	TWS 30300 CR
	330 mm	TWS 30295	TWS 30298 C	TWS 30301 CR
	450 mm	TWS 30296	TWS 30299 C	TWS 30302 CR
 Grasping & dissecting forceps, fenestrated 12 mm	220 mm	TWS 30303	TWS 30306 C	TWS 30309 CR
	330 mm	TWS 30304	TWS 30307 C	TWS 30310 CR
	450 mm	TWS 30305	TWS 30308 C	TWS 30311 CR
 Micro grasping & dissecting forceps, oval, fenestrated	220 mm	TWS 30312	TWS 30315 C	TWS 30318 CR
	330 mm	TWS 30313	TWS 30316 C	TWS 30319 CR
	450 mm	TWS 30314	TWS 30317 C	TWS 30320 CR

Monopolar Laparoscopy instruments, shaft Ø 5.0 mm



TW Surgical

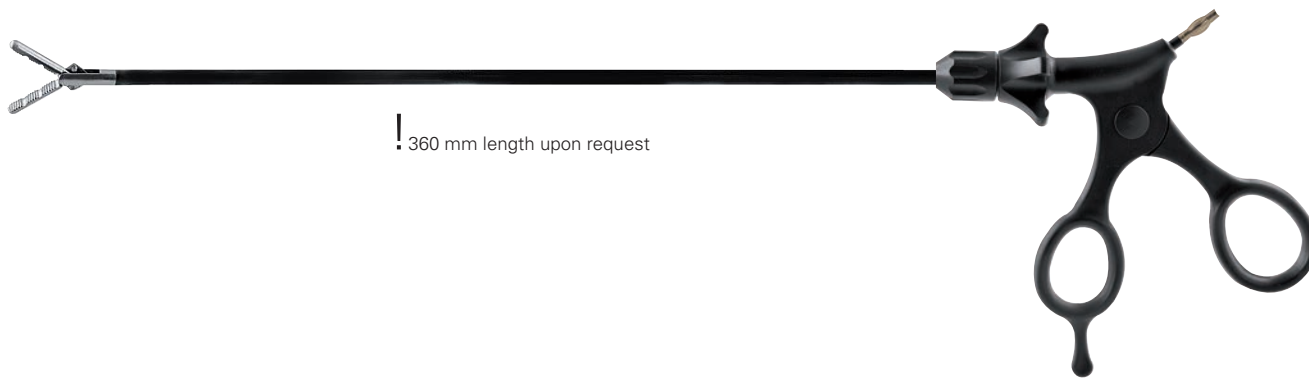









! 360 mm length upon request

rotatable, detachable with HF-connection

Ø 5,0 mm



Version	Length	Insert, only	without ratchet	with ratchet
 Grasping & dissecting forceps, fenestrated	220 mm	TWS 30321	TWS 30324 C	TWS 30326 CR
	330 mm	TWS 30322	TWS 30326 C	TWS 30327 CR
	450 mm	TWS 30323	TWS 30325 C	TWS 30328 CR
 Grasping & dissecting forceps, conical, cross serrated	220 mm	TWS 30329	TWS 30332 C	TWS 30335 CR
	330 mm	TWS 30330	TWS 30333 C	TWS 30336 CR
	450 mm	TWS 30331	TWS 30334 C	TWS 30337 CR
 Grasping & dissecting forceps, conical, cross serrated	220 mm	TWS 30338	TWS 30341 C	TWS 30344 CR
	330 mm	TWS 30339	TWS 30342 C	TWS 30345 CR
	450 mm	TWS 30340	TWS 30343 C	TWS 30346 CR
 Grasping & dissecting forceps, serrated with spoon, pointed	220 mm	TWS 30347	TWS 30350 C	TWS 30354 CR
	330 mm	TWS 30348	TWS 30351 C	TWS 30353 CR
	450 mm	TWS 30349	TWS 30352 C	TWS 30355 CR
 Grasping & dissecting forceps, serrated with spoon	220 mm	TWS 30356	TWS 30359 C	TWS 30362 CR
	330 mm	TWS 30357	TWS 30360 C	TWS 30363 CR
	450 mm	TWS 30358	TWS 30361 C	TWS 30364 CR
 Dolphin grasping & dissecting forceps, short spoon	220 mm	TWS 30365	TWS 30368 C	TWS 30370 CR
	330 mm	TWS 30366	TWS 30368 C	TWS 30371 CR
	450 mm	TWS 30367	TWS 30369 C	TWS 30372 CR
 Dolphin grasping & dissecting forceps, long spoon	220 mm	TWS 30374	TWS 30376 C	TWS 30379 CR
	330 mm	TWS 30373	TWS 30377 C	TWS 30380 CR
	450 mm	TWS 30375	TWS 30378 C	TWS 30381 CR
 Grasping & dissecting forceps, long delicate jaw, serrated	220 mm	TWS 30382	TWS 30385 C	TWS 30388 CR
	330 mm	TWS 30383	TWS 30386 C	TWS 30389 CR
	450 mm	TWS 30384	TWS 30387 C	TWS 30390 CR

Treasure Wright (U.K.) Ltd.

128-160 City Road, London, EC1V 2NX, United Kingdom
 info@twrightmedical.com

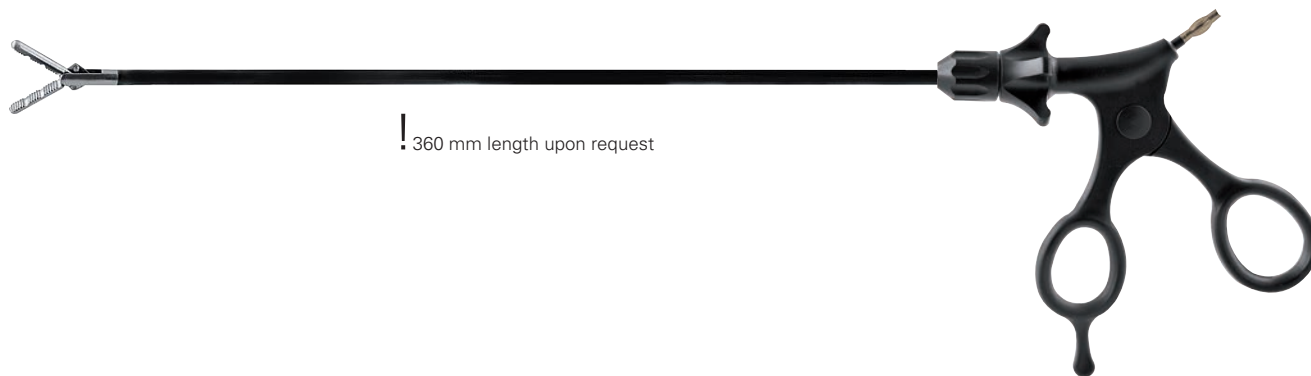

! 360 mm length upon request

rotatable, detachable with HF-connection



Ø 5,0 mm

	Version	Length	Insert, only	without ratchet	with ratchet
		220 mm	TWS 30391	TWS 30394 C	TWS 30397 CR
		330 mm	TWS 30392	TWS 30395 C	TWS 30398 CR
		450 mm	TWS 30393	TWS 30396 C	TWS 30399 CR
		220 mm	TWS 30400	TWS 30404 C	TWS 30406 CR
		330 mm	TWS 30401	TWS 30403 C	TWS 30407 CR
		450 mm	TWS 30402	TWS 30405 C	TWS 30408 CR
		220 mm	TWS 30409	TWS 30412 C	TWS 30414 CR
		330 mm	TWS 30410	TWS 30413 C	TWS 30416 CR
		450 mm	TWS 30411	TWS 30415 C	TWS 30417 CR
		220 mm	TWS 30418	TWS 30422 C	TWS 30425 CR
		330 mm	TWS 30419	TWS 30423 C	TWS 30426 CR
		450 mm	TWS 30420	TWS 30424 C	TWS 30427 CR
		220 mm	TWS 30428	TWS 30431 C	TWS 30434 CR
		330 mm	TWS 30429	TWS 30432 C	TWS 30436 CR
		450 mm	TWS 30430	TWS 30433 C	TWS 30435 CR
		220 mm	TWS 30437	TWS 30440 C	TWS 30444 CR
		330 mm	TWS 30438	TWS 30441 C	TWS 30443 CR
		450 mm	TWS 30439	TWS 30442 C	TWS 30445 CR
		220 mm	TWS 30446	TWS 30449 C	TWS 30452 CR
		330 mm	TWS 30447	TWS 30450 C	TWS 30453 CR
		450 mm	TWS 30448	TWS 30451 C	TWS 30454 CR
		220 mm	TWS 30455	TWS 30458 C	TWS 30461 CR
		330 mm	TWS 30456	TWS 30459 C	TWS 30462 CR
		450 mm	TWS 30457	TWS 30460 C	TWS 30463 CR
		220 mm	TWS 30464	TWS 30467 C	TWS 30470 CR
		330 mm	TWS 30465	TWS 30468 C	TWS 30471 CR
		450 mm	TWS 30466	TWS 30469 C	TWS 30472 CR

Monopolar Laparoscopy instruments, shaft Ø 5.0 mm



TW Surgical

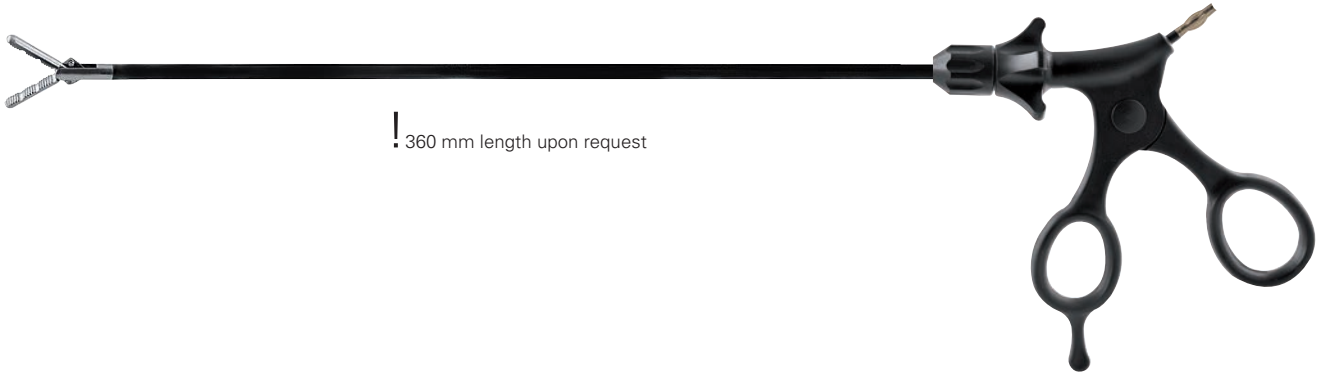









! 360 mm length upon request

rotatable, detachable with HF-connection

Ø 5,0 mm



Version	Length	Insert, only	without ratchet	with ratchet
 MIXTER grasping & dissecting fcps., 60° angled, cross serrated	220 mm	TWS 30473	7TWS 30521 C	TWS 30522 CR
	330 mm	TWS 30474	TWS 30520 C	TWS 30523 CR
	450 mm	TWS 30475	TWS 30519 C	TWS 30524 CR
 MIXTER grasping & dissecting fcps., 90° angled, cross serrated	220 mm	TWS 30476	TWS 30518 C	TWS 30526 CR
	330 mm	TWS 30477	TWS 30517 C	TWS 30527 CR
	450 mm	TWS 30478	TWS 30516 C	TWS 30525 CR
 KELLY grasping & dissecting forceps, short, cross serrated	220 mm	TWS 30479	TWS 30517 C	TWS 30528 CR
	330 mm	TWS 30480	TWS 30515 C	TWS 30529 CR
	450 mm	TWS 30481	TWS 30514 C	TWS 30530 CR
 KELLY grasping & dissecting forceps, cross serrated	220 mm	TWS 30482	TWS 30512 C	TWS 30531 CR
	330 mm	TWS 30483	TWS 30513 C	TWS 30532 CR
	450 mm	TWS 30484	TWS 30510 C	TWS 30533 CR
 KELLY grasping & dissecting forceps, short, cross serrated	220 mm	TWS 30486	TWS 30509 C	TWS 30534 CR
	330 mm	TWS 30487	TWS 30508 C	TWS 30535 CR
	450 mm	TWS 30488	TWS 30507 C	TWS 30536 CR
 Micro grasping forceps, fenestrated	220 mm	TWS 30489	TWS 30504 C	TWS 30537 CR
	330 mm	TWS 30490	TWS 30505 C	TWS 30538 CR
	450 mm	TWS 30491	TWS 30506 C	TWS 30539 CR
 PRESTIGE grasping forceps, wavy serrated with spoon	220 mm	TWS 30492	TWS 30501 C	TWS 30540 CR
	330 mm	TWS 30493	TWS 30502 C	TWS 30541 CR
	450 mm	TWS 30494	TWS 30503 C	TWS 30552 CR
 Adhesion forceps	220 mm	TWS 30495	TWS 30500 C	TWS 30554 CR
	330 mm	TWS 30496	TWS 30499 C	TWS 30553 CR
	450 mm	TWS 30497	TWS 30498 C	TWS 30555 CR

Treasure Wright (U.K.) Ltd.

128-160 City Road, London, EC1V 2NX, United Kingdom
info@twrightmedical.com

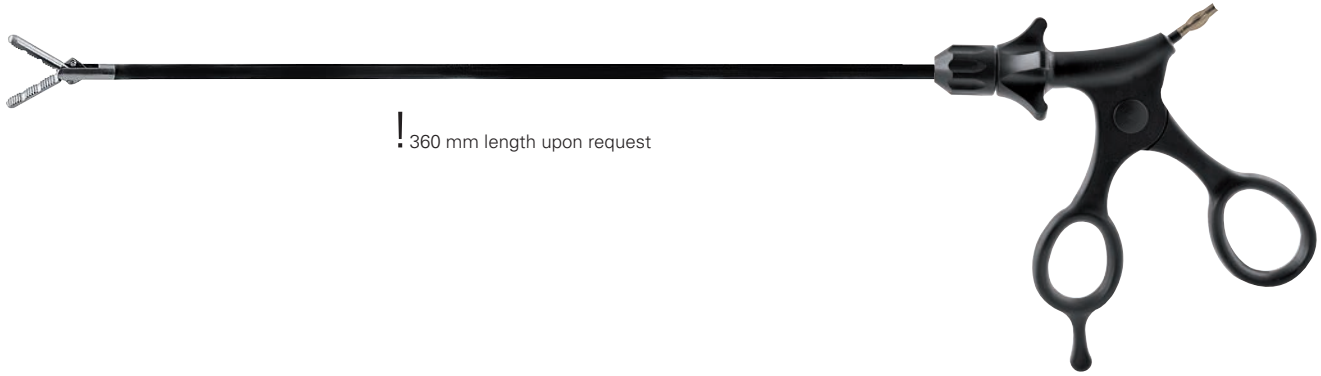









! 360 mm length upon request

rotatable, detachable with HF-connection

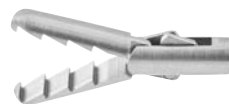
Ø 5,0 mm



Version	Length	Insert, only	without ratchet	with ratchet
 Ovarian grasping & dissecting forceps	220 mm	TWS 30556	TWS 30562 C	TWS 30565 CR
	330 mm	TWS 30557	TWS 30563 C	TWS 30566 CR
	450 mm	TWS 30558	TWS 30564 C	TWS 30567 CR
 TC Grasping forceps, long jaw	220 mm	TWS 30559	TWS 30561 C	TWS 30568 CR
	330 mm	TWS 30560	TWS 30562 C	TWS 30569 CR
	450 mm	TWS 30561	TWS 30563 C	TWS 30560 CR
 Alligator grasping & extraction forceps with spoon	220 mm	TWS 30564	TWS 30567 C	TWS 30570 CR
	330 mm	TWS 30565	TWS 30568 C	TWS 30571 CR
	450 mm	TWS 30566	TWS 30569 C	TWS 30572 CR
 Alligator grasping & extraction forceps	220 mm	TWS 30576	TWS 30579 C	TWS 30575 CR
	330 mm	TWS 30577	TWS 30580 C	TWS 30573 CR
	450 mm	TWS 30578	TWS 30581 C	TWS 30574 CR
 Alligator grasping & extraction forceps, retrograde serration	220 mm	TWS 30582	TWS 30588 C	TWS 30592 CR
	330 mm	TWS 30583	TWS 30589 C	TWS 30593 CR
	450 mm	TWS 30584	TWS 30590 C	TWS 30591 CR
 DAVIS grasping forceps, 2 x 3 blunt teeth	220 mm	TWS 30585	TWS 30594 C	TWS 30597 CR
	330 mm	TWS 30586	TWS 30595 C	TWS 30598 CR
	450 mm	TWS 30587	TWS 30596 C	TWS 30599 CR
 Grasping forceps with teeth row	220 mm	TWS 30600	TWS 30606 C	TWS 30609 CR
	330 mm	TWS 30601	TWS 30607 C	TWS 30610 CR
	450 mm	TWS 30602	TWS 30608 C	TWS 30611 CR
 ALLIS grasping forceps, 2 x 4 teeth	220 mm	TWS 30603	TWS 30615 C	TWS 30612 CR
	330 mm	TWS 30604	TWS 30616 C	TWS 30613 CR
	450 mm	TWS 30605	TWS 30617 C	TWS 30614 CR

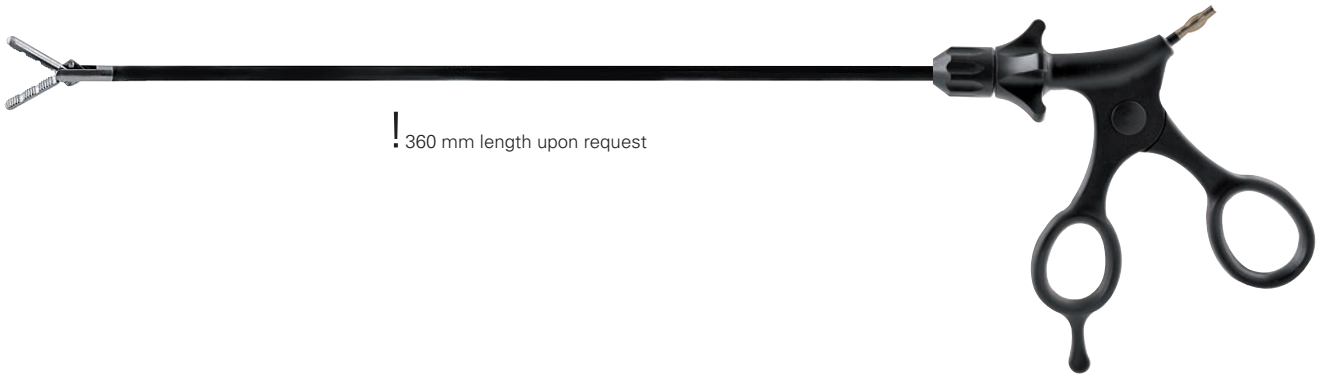

! 360 mm length upon request

rotatable, detachable with HF-connection

Ø 5,0 mm

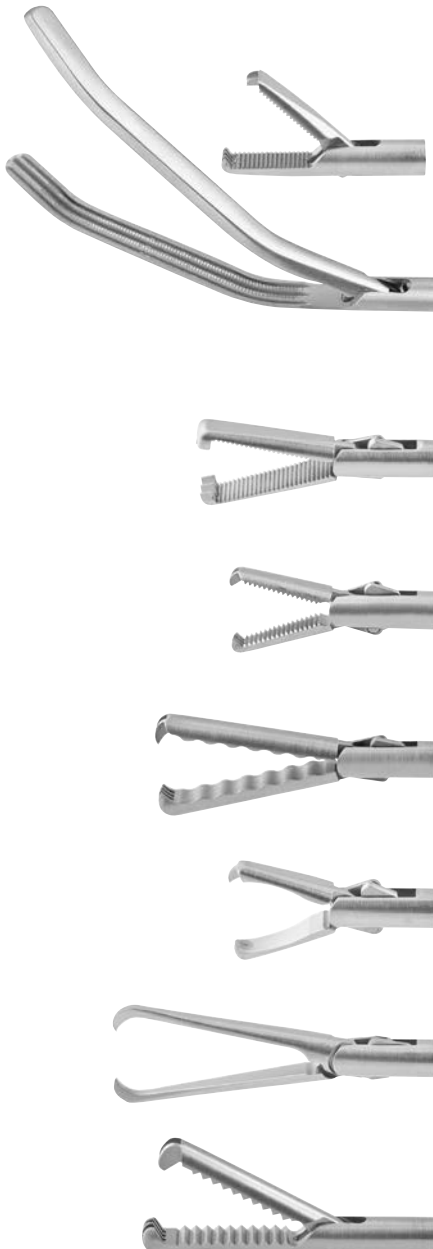

Version	Length	Insert, only	without ratchet	with ratchet
Kocher grasping forceps, 2 x 4 teeth, serrated	220 mm	TWS 30618	TWS 30622 C	TWS 30624 CR
	330 mm	TWS 30619	TWS 30623 C	TWS 30626 CR
	450 mm	TWS 30620	TWS 30621 C	TWS 30625 CR
SATINSKY atraumatic grasping forceps, right curved, 50 mm	220 mm	TWS 30632	TWS 30630 C	TWS 30627 CR
	330 mm	TWS 30633	TWS 30634 C	TWS 30628 CR
	450 mm	TWS 30631	TWS 30635 C	TWS 30629CR
Kocher grasping forceps, 2 x 3 teeth, serrated	220 mm	TWS 30636	TWS 30639 C	TWS 30632 CR
	330 mm	TWS 30637	TWS 30640 C	TWS 30633 CR
	450 mm	TWS 30638	TWS 30631 C	TWS 30634 CR
Grasping forceps, 2 x 4 teeth, delicate, flat, serrated	220 mm	TWS 30652	TWS 30650 C	TWS 30647 CR
	330 mm	TWS 30653	TWS 30649 C	TWS 30646 CR
	450 mm	TWS 30651	TWS 30648 C	TWS 30645 CR
Grasping forceps, 2 x 4 teeth, wavy serrated	220 mm	TWS 30654	TWS 30660 C	TWS 30657 CR
	330 mm	TWS 30661	TWS 30659 C	TWS 30656 CR
	450 mm	TWS 30662	TWS 30658 C	TWS 30655 CR
Grasping forceps, 1 x 2 pointed teeth	220 mm	TWS 30666	TWS 30669 C	TWS 30664 CR
	330 mm	TWS 30667	TWS 30670 C	TWS 30663 CR
	450 mm	TWS 30668	TWS 30671 C	TWS 30665 CR
Tenaculum forceps	220 mm	TWS 30678	TWS 30677 C	TWS 30672 CR
	330 mm	TWS 30679	TWS 30676 C	TWS 30673 CR
	450 mm	TWS 30680	TWS 30675 C	TWS 30674 CR
Retraction forceps	220 mm	TWS 30689	TWS 30687 C	TWS 30682 CR
	330 mm	TWS 30688	TWS 30686 C	TWS 30683 CR
	450 mm	TWS 30685	TWS 30681 C	TWS 30684 CR

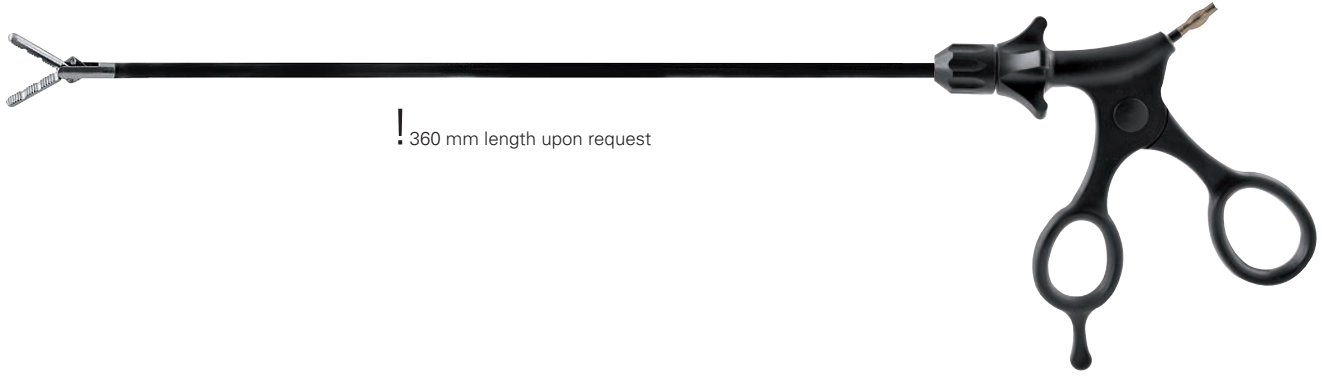









! 360 mm length upon request

rotatable, detachable with HF-connection

Ø 5,0 mm



Version	Length	Insert, only	without ratchet	with ratchet
 Claw grasping forceps, 2 x 3 teeth	220 mm	TWS 30690	TWS 30697 C	TWS 30692 CR
	330 mm	TWS 30698	TWS 30696 C	TWS 30693 CR
	450 mm	TWS 30699	TWS 30695 C	TWS 30694 CR
 Claw grasping forceps, 2 x 3 teeth	220 mm	TWS 30670	TWS 30674 C	TWS 30672 CR
	330 mm	TWS 30671	TWS 30676 C	TWS 30673 CR
	450 mm	TWS 30678	TWS 30677 C	TWS 30675 CR
 Claw grasping forceps, 1 x 2 teeth	220 mm	TWS 30679	TWS 30682 C	TWS 30684 CR
	330 mm	TWS 30680	TWS 30683 C	TWS 30686 CR
	450 mm	TWS 30681	TWS 30685 C	TWS 30687 CR
 BABCOCK grasping forceps	220 mm	TWS 30688	TWS 30692 C	TWS 30691 CR
	330 mm	TWS 30689	TWS 30693 C	TWS 30696 CR
	450 mm	TWS 30690	TWS 30694 C	TWS 30695 CR
 BABCOCK-PADDLE grasping forceps	220 mm	TWS 30697	TWS 30700 C	TWS 30702 CR
	330 mm	TWS 30698	TWS 30703 C	TWS 30701CR
	450 mm	TWS 30699	TWS 30705 C	TWS 30704 CR
 BABCOCK grasping forceps	220 mm	TWS 30706	TWS 30712 C	TWS 30714 CR
	330 mm	TWS 30707	TWS 30713 C	TWS 30716 CR
	450 mm	TWS 30708	TWS 30715 C	TWS 30717 CR
 Atraumatic intestinal grasping forceps, long jaw, fenestrated	220 mm	TWS 30709	TWS 30718 C	TWS 30721 CR
	330 mm	TWS 30710	TWS 30719 C	TWS 30723 CR
	450 mm	TWS 30711	TWS 30720 C	TWS 30722 CR
 ALLIS grasping forceps	220 mm	TWS 30724	TWS 30727 C	TWS 30730 CR
	330 mm	TWS 30726	TWS 30728 C	TWS 30731 CR
	450 mm	TWS 30725	TWS 30729 C	TWS 30732 CR

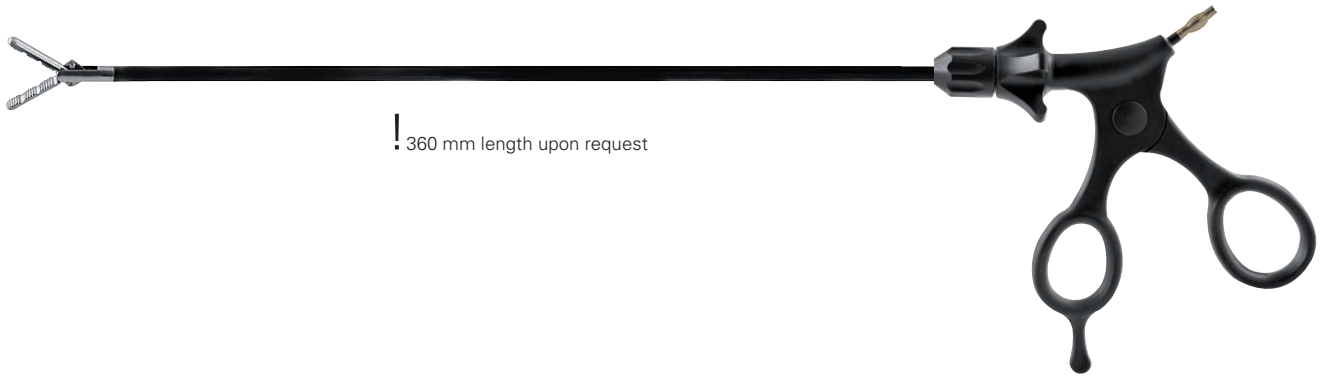

! 360 mm length upon request

rotatable, detachable with HF-connection



Ø 5,0 mm

Version	Length	Insert, only	without ratchet	with ratchet
 <p>grasping forceps, atraumatic serration, fenestrated</p>	220 mm	TWS 30733	TWS 30740 C	TWS 30744 CR
	330 mm	TWS 30734	TWS 30742 C	TWS 30746 CR
	450 mm	TWS 30735	TWS 30743 C	TWS 30745 CR
 <p>Grasping forceps, heavy toothed, perforated</p>	220 mm	TWS 30736	TWS 30747 C	TWS 30750 CR
	330 mm	TWS 30737	TWS 30748 C	TWS 30751 CR
	450 mm	TWS 30738	TWS 30749 C	TWS 30752 CR
 <p>DE BAKEY atraumatic pick-up grasping forceps</p>	220 mm	TWS 30759	TWS 30756 C	TWS 30755 CR
	330 mm	TWS 30760	TWS 30757 C	TWS 30753 CR
	450 mm	TWS 30761	TWS 30758 C	TWS 30754 CR
 <p>DE BAKEY atraumatic grasping forceps, jaw length 25 mm</p>	220 mm	TWS 30762	TWS 30765 C	TWS 30768 CR
	330 mm	TWS 30763	TWS 30766 C	TWS 30769 CR
	450 mm	TWS 30764	TWS 30767 C	TWS 30770 CR
 <p>DE BAKEY atraumatic grasping forceps, jaw length 40 mm</p>	220 mm	TWS 30771	TWS 30780 C	TWS 30783 CR
	330 mm	TWS 30772	TWS 30781 C	TWS 30784 CR
	450 mm	TWS 30773	TWS 30782 C	TWS 30785 CR
 <p>DE BAKEY atraumatic grasping forceps, jaw length 60 mm</p>	220 mm	TWS 30774	TWS 30789 C	TWS 30786 CR
	330 mm	TWS 30775	TWS 30790 C	TWS 30787 CR
	450 mm	TWS 30779	TWS 30791 C	TWS 30788 CR
 <p>grasping forceps</p>	220 mm	TWS 30777	TWS 30792 C	TWS 30797 CR
	330 mm	TWS 30778	TWS 30793 C	TWS 30796 CR
	450 mm	TWS 30779	TWS 30794 C	TWS 30795 CR
 <p>Tube grasping forceps, smooth</p>	220 mm	TWS 30798	TWS 30802 C	TWS 30801 CR
	330 mm	TWS 30799	TWS 30803 C	TWS 30804 CR
	450 mm	TWS 30800	TWS 30805 C	TWS 30806 CR

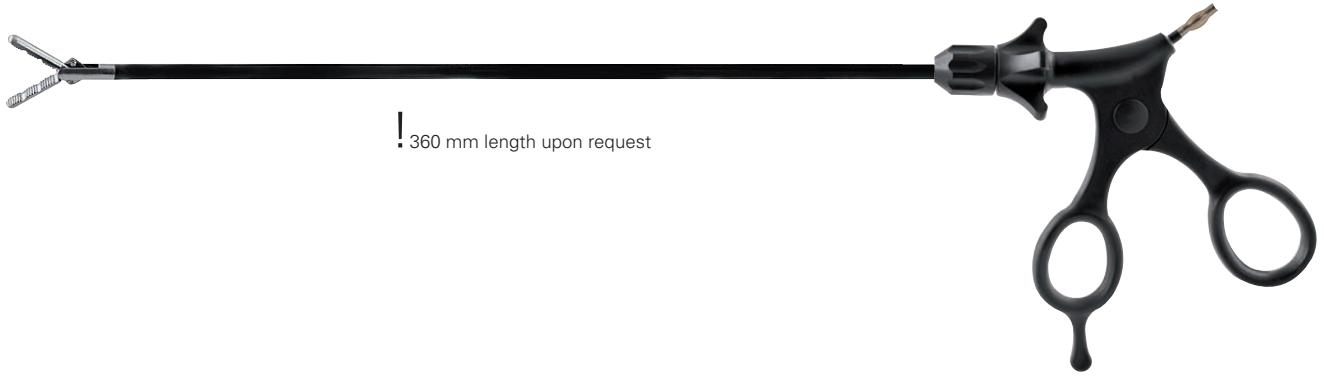







! 360 mm length upon request

rotatable, detachable with HF-connection

Ø 5,0 mm



Version	Length	Insert, only	without ratchet	with ratchet
 Grasping forceps, double fenestrated	220 mm	TWS 30807	TWS 30810 C	TWS 30814 CR
	330 mm	TWS 30808	TWS 30812 C	TWS 30815 CR
	450 mm	TWS 30809	TWS 30813 C	TWS 30816 CR
 Grasping forceps, double fenestrated, slightly curved up	220 mm	TWS 30825	TWS 30824 C	TWS 30817 CR
	330 mm	TWS 30826	TWS 30822 C	TWS 30818 CR
	450 mm	TWS 30827	TWS 30820 C	TWS 30819 CR
 Grasping forceps, triple fenestrated	220 mm	TWS 30828	TWS 30831 C	TWS 30834 CR
	330 mm	TWS 30829	TWS 30832 C	TWS 30835 CR
	450 mm	TWS 30830	TWS 30833 C	TWS 30836 CR
 Grasping forceps, double fenestrated	220 mm	TWS 30837	TWS 30840 C	TWS 30843 CR
	330 mm	TWS 30838	TWS 30841 C	TWS 30844 CR
	450 mm	TWS 30839	TWS 30842 C	TWS 30845 CR
 Grasping forceps, triple fenestrated	220 mm	TWS 30846	TWS 30849C	TWS 30852 CR
	330 mm	TWS 30848	TWS 30850 C	TWS 30853 CR
	450 mm	TWS 30847	TWS 30851 C	TWS 30855 CR
 Grasping forceps, concave curved, cross serrated	220 mm	TWS 30854	TWS 30858 C	TWS 30862 CR
	330 mm	TWS 30856	TWS 30859 C	TWS 30863 CR
	450 mm	TWS 30857	TWS 30860 C	TWS 30865 CR

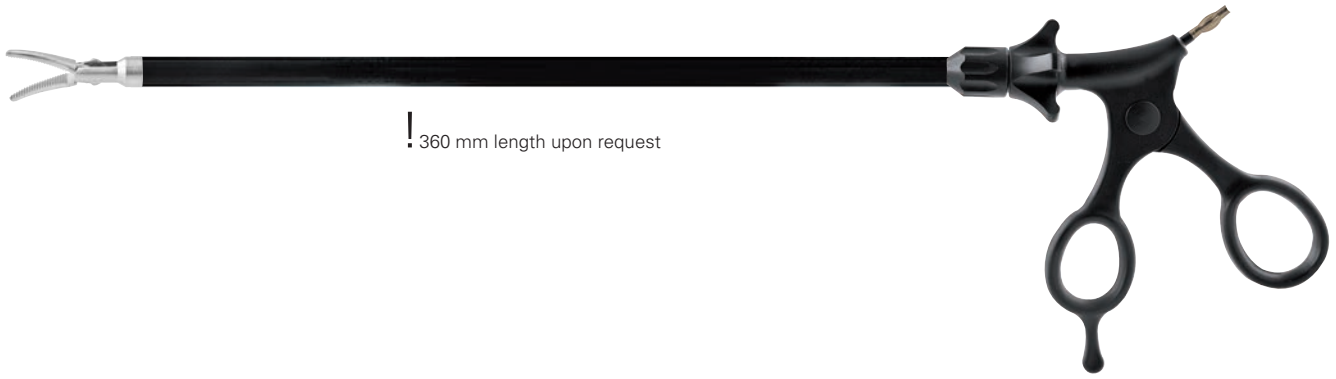

! 360 mm length upon request

rotatable, detachable with HF-connection

Ø 10,0 mm



Version	Length	Insert, only	without ratchet	with ratchet
Biopsy forceps, spoon oval	330 mm	TWS 30866	TWS 30868 C	
	450 mm	TWS 30867	TWS 30869 C	



MARYLAND grasping & dissecting forceps, serrated	330 mm	TWS 30870	TWS 30873 C	TWS 30874 CR
	450 mm	TWS 30871	TWS 30872 C	TWS 30875 CR



MIXTER grasping & dissecting forceps., 90° angled, serrated	330 mm	TWS 30876	TWS 30880 C	TWS 30883 CR
	450 mm	TWS 30877	TWS 30881 C	TWS 30885 CR



MIXTER grasping & dissecting forceps., 90° angled, fine serrated	330 mm	TWS 30878	TWS 30884 C	TWS 30886 CR
	450 mm	TWS 30879	TWS 30882 C	TWS 30887 CR



OVERHOLT grasping & dissecting forceps	330 mm	TWS 30888	TWS 30890 C	TWS 30892 CR
	450 mm	TWS 30889	TWS 30891 C	TWS 30893 CR



Overholt Mixer grasping & dissecting forceps, slim jaw, serrated	330 mm	TWS 30894	TWS 30896 C	TWS 30898 CR
	450 mm	TWS 30895	TWS 30897 C	TWS 30899 CR



Tenaculum forceps, 1 x 1 teeth	330 mm	TWS 30900	TWS 30902 C	TWS 30904 CR
	450 mm	TWS 30901	TWS 30903 C	TWS 30905 CR

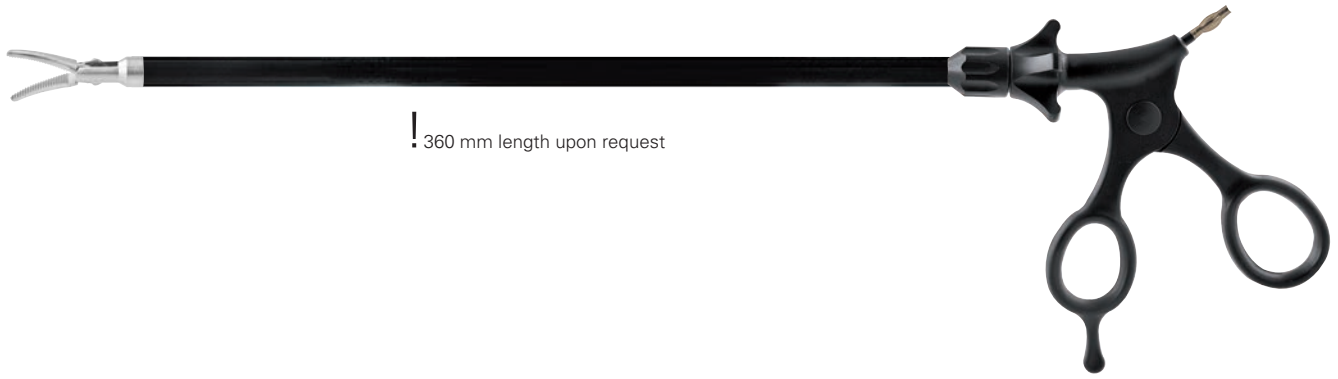

! 360 mm length upon request

rotatable, detachable with HF-connection

Ø 10,0 mm



Version	Length	Insert, only		
		without ratchet	with ratchet	
 Claw grasping forceps, 2 x 3 teeth	330 mm	TWS 30906	73-479-33 C	73-479-33 CR
	450 mm	TWS 30907	73-479-45 C	73-479-45 CR
 Claw grasping forceps, 2 x 3 teeth	330 mm	TWS 30908	TWS 30912 C	TWS 30916 CR
	450 mm	TWS 30909	TWS 30913 C	TWS 30917 CR
 BABCOCK grasping forceps	330 mm	TWS 30910	TWS 30914 C	TWS 30918 CR
	450 mm	TWS 30911	TWS 30915 C	TWS 30919 CR
 BABCOCK atraumatic grasping forceps, round fenestrated	330 mm	TWS 30920	TWS 30924 C	TWS 30928 CR
	450 mm	TWS 30921	TWS 30925 C	TWS 30929 CR
 ALLIS grasping forceps	330 mm	TWS 30922	TWS 30926 C	TWS 30930 CR
	450 mm	TWS 30923	TWS 30927 C	TWS 30931 CR
 DORSEY grasping forceps, serrated	330 mm	TWS 30932	TWS 30936 C	TWS 30938 CR
	450 mm	TWS 30933	TWS 30937 C	TWS 30939 CR
 DE BAKEY atraumatic grasping forceps, jaw length 25 mm	330 mm	TWS 30934	TWS 30940 C	TWS 30942 CR
	450 mm	TWS 30935	TWS 30941 C	TWS 30943 CR

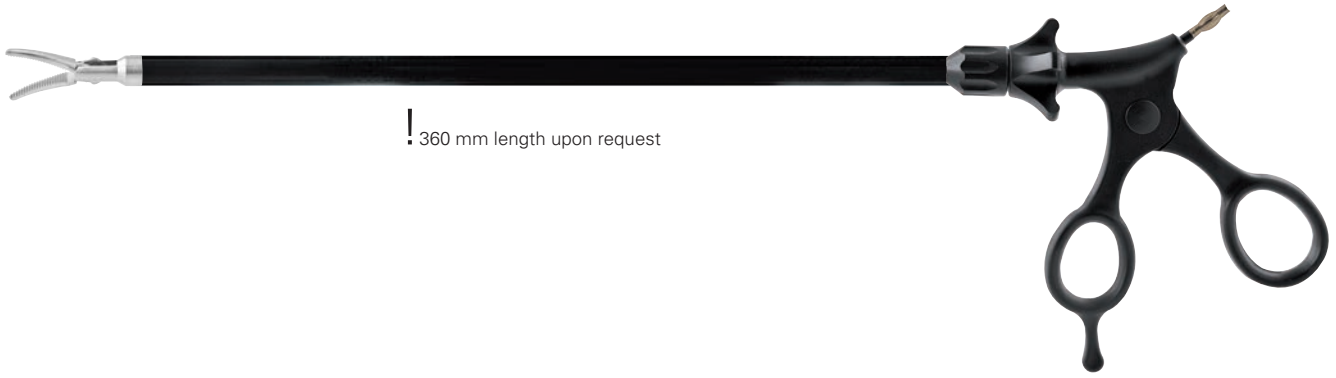

! 360 mm length upon request

rotatable, detachable with HF-connection



Ø 10,0 mm

Version	Length	Insert, only	without ratchet	with ratchet
 DE BAKEY atraumatic grasping forceps, jaw length 40 mm	330 mm	TWS 30944	TWS 30946 C	TWS 30949 CR
	450 mm	TWS 30945	TWS 30947 C	TWS 30950 CR
 DUVAL grasping forceps, fenestrated	330 mm	TWS 30951	TWS 30953 C	TWS 30956 CR
	450 mm	TWS 30952	TWS 30954 C	TWS 30955 CR
 COLLIN grasping forceps, serrated	330 mm	TWS 30957	TWS 30959 C	TWS 30961 CR
	450 mm	TWS 30958	TWS 30960 C	TWS 30962 CR
 Dissecting forceps, curved, delicate, cross serrated	330 mm	TWS 30963	TWS 30964 C	TWS 30967 CR
	450 mm	TWS 30965	TWS 30966 C	TWS 30968 CR
 DE BAKEY atraumatic grasping forceps, jaw length 60 mm	330 mm	TWS 30969	TWS 30973 C	TWS 30975 CR
	450 mm	TWS 30970	TWS 30974 C	TWS 30976 CR
 grasping forceps	330 mm	TWS 30971	TWS 30980 C	TWS 30977 CR
	450 mm	TWS 30972	TWS 30979 C	TWS 30978 CR
 Grasping forceps, horizontal serrated, hollow jaw	330 mm	TWS 30981	TWS 30983 C	TWS 30986 CR
	450 mm	TWS 30982	TWS 30984 C	TWS 30985 CR



TW Surgical

Endo needle holders, Compact Endo needle holders

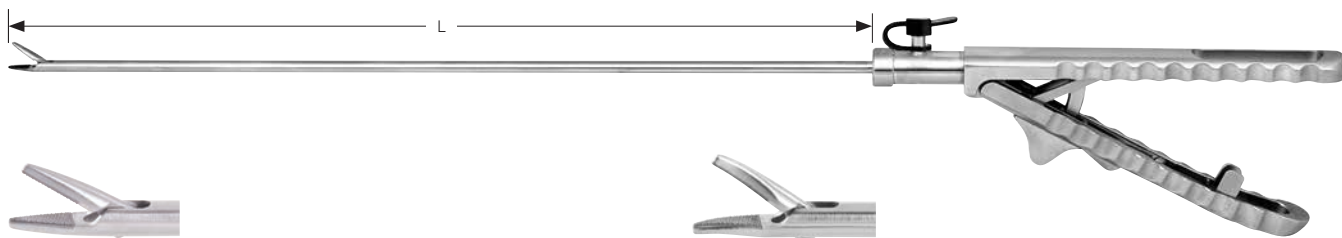

TWS 30987 Ø 3,0 x 330 mm

TWS 30988 Ø 5,0 x 330 mm

TWS 30989 XL Ø 5,0 x 450 mm



TWS 30990 Ø 3,0 x 330 mm

TWS 30991 Ø 5,0 x 330 mm

TWS 30992 XL Ø 5,0 x 450 mm

Endo TC needle holder, straight, LUER-LOCK irrigation port, massive axial handle

Endo TC needle holder, left curved, LUER-LOCK irrigation port, massive axial handle



TWS 30993 Ø 3,0 x 330 mm

TWS 30994 Ø 5,0 x 330 mm

TWS 30995 XL Ø 5,0 x 450 mm



TWSFLAM

TWS 30996 Ø 5,0 x 330 mm

TWS 30997 XL Ø 5,0 x 450 mm

Endo TC needle holder, right curved, LUER-LOCK irrigation port, ergonomic axial handle

Endo counter needle holder, curved up, LUER-LOCK irrigation port, ergonomic axial handle, self adjusting

Compact Endo needle holder



TWS 30998 Ø 5,0 x 330 mm



TWS 30999 Ø 5,0 x 330 mm

Endo TC needle holder, straight, LUER-LOCK irrigation port, ring handle

Endo TC needle holder, left curved, LUER-LOCK irrigation port, ring handle



TWS 31000 Ø 5,0 x 330 mm

Endo TC needle holder, right curved, LUER-LOCK irrigation port, ring handle

Treasure Wright (U.K.) Ltd.

128-160 City Road, London, EC1V 2NX, United Kingdom
info@twrightmedical.com

TWS Light Endo needle holders



TWS 31001	Ø 3,0 x 330 mm
TWS 31002	Ø 5,0 x 330 mm
TWS 31003 XL	Ø 5,0 x 450 mm

TWS 31004	Ø 3,0 x 330 mm
TWS 31005	Ø 5,0 x 330 mm
TWS 31006 XL	Ø 5,0 x 450 mm

Endo TC needle holder, straight, LUER-LOCK irrigation port, straight aluminium handle

Endo TC needle holder, left curved, LUER-LOCK irrigation port, straight aluminium handle



TWS 31007	Ø 3,0 x 330 mm
TWS 31008	Ø 5,0 x 330 mm
TWS 31009 XL	Ø 5,0 x 450 mm

TWSFLAM

TWS 31010	Ø 5,0 x 330 mm
TWS 31011 XL	Ø 5,0 x 450 mm

Endo TC needle holder, right curved, LUER-LOCK irrigation port, straight aluminium handle

Endo counter needle holder, curved up, LUER-LOCK irrigation port, straight aluminium handle, self adjusting



TWS 31012	Ø 3,0 x 330 mm
TWS 31013	Ø 5,0 x 330 mm
TWS 31014 XL	Ø 5,0 x 450 mm

TWS 31015	Ø 3,0 x 330 mm
TWS 31016	Ø 5,0 x 330 mm
TWS 31017 XL	Ø 5,0 x 450 mm

Endo TC needle holder, straight, LUER-LOCK irrigation port, angled aluminium handle

Endo TC needle holder, left curved, LUER-LOCK irrigation port, angled aluminium handle



TWS 31018	Ø 3,0 x 330 mm
TWS 31019	Ø 5,0 x 330 mm
TWS 31020 XL	Ø 5,0 x 450 mm

TWSFLAM

TWS 31021	Ø 5,0 x 330 mm
TWS 31022 XL	Ø 5,0 x 450 mm

Endo TC needle holder, right curved, LUER-LOCK irrigation port, angled aluminium handle

Endo counter needle holder, curved up, LUER-LOCK irrigation port, straight aluminium handle, self adjusting

Treasure Wright (U.K.) Ltd.

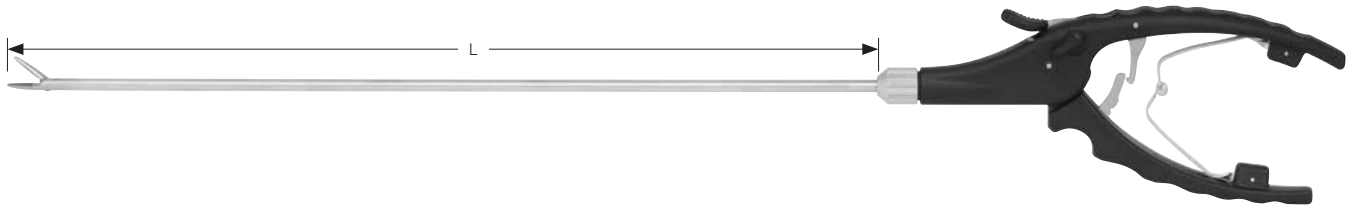

TWS 31023 Ø 5,0 x 330 mm

Endo TC needle holder, straight, axial plastic handle



TWS 31024 Ø 5,0 x 330 mm

Endo TC needle holder, left curved, axial plastic handle



TWS 31025 Ø 5,0 x 330 mm

Endo TC needle holder, right curved, axial plastic handle

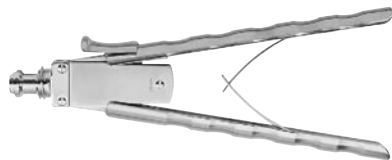

TWS 31026

handle, straight with ratchet



TWS 31027

handle, angled with ratchet



Länge
Length Ø 5,0 mm

330 mm	TWS 31028
360 mm	TWS 31029
450 mm	TWS 31030

insulated



- TWS 31031** Ø 5,0 x 330 mm
- TWS 31032** Ø 5,0 x 360 mm
- TWS 31033** Ø 5,0 x 450 mm

Endo TC needle holder, straight, insert only



- TWS 31034** Ø 5,0 x 330 mm
- TWS 31035** Ø 5,0 x 360 mm
- TWS 31036** Ø 5,0 x 450 mm

Endo TC needle holder, left curved, insert only



- TWS 31037** Ø 5,0 x 330 mm
- TWS 31038** Ø 5,0 x 360 mm
- TWS 31039** Ø 5,0 x 450 mm

Endo TC needle holder, right curved, insert only



TWS 31040 Ø 5,0 x 330 mm

Suture instrument for intracorporeal suture and knot technique with LUER-LOCK rinsing channel

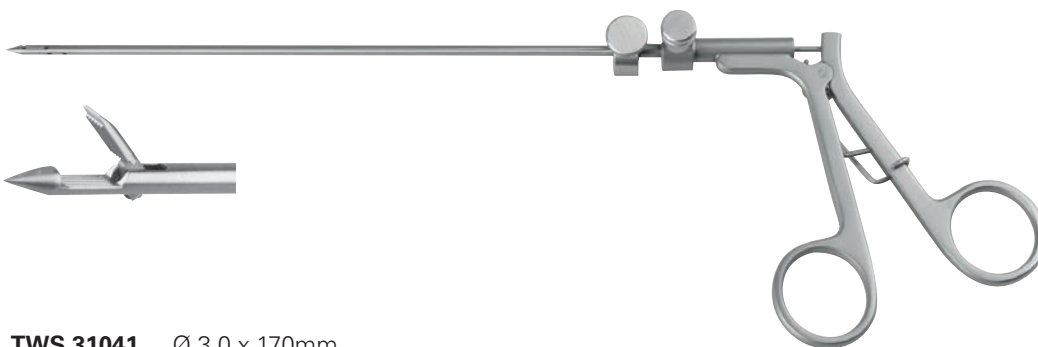

TWS 31041 Ø 3,0 x 170mm

Suture instrument for subcutaneous fascial closure, ring handle and LUER-LOCK rinsing channel

Advantages:

- Reduces or eliminates the possibility of trocar site hernia, wound dehiscence or bleeding
- Multiple applications with controlled entry and depth safety stopper
- Easy to use, especially on adipose patients
- Quality reusable instrument

Technique:

Place suture in jaw near the middle of the suture length. Surgeon will place instrument (with suture) beneath level of skin full thickness incorporating posterior fascia directly adjacent to trocar cannula. This technique should be performed under laparoscopic vision. It is necessary to have an adequate length of suture in the peritoneal cavity so it can be easily retrieved and extracted when the instrument is reintroduced on the opposite side of trocar site.

Once the suture is introduced satisfactorily it is dropped (1) and instrument is extracted and reintroduced on opposite side (2). Suture is re-grasped and extracted with instrument incorporating all tissue layers. Abdominal wall is then closed in normal fashion (3).

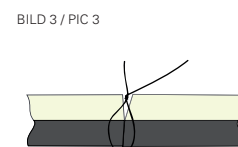
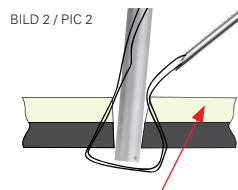
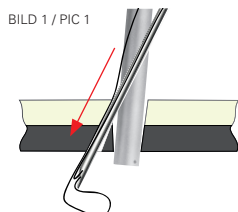

Suture and ligature instruments



TWS 31042 Ø 4,0 x 330 mm

TWS 31043 Ø 4,0 x 450 mm

Knot guide with open eye



TWS 31044 Ø 4,0 x 330 mm

TWS 31045 Ø 4,0 x 450 mm

Knot guide with closed eye



TWS 31046 Ø 4,5 x 330 mm

Knot guide with slot



TWS 31047 Ø 2,3 x 140 mm

Suture instrument for subcutaneous fascial closure

BILD 1 / PIC 1



Thread the suture into the fascia-suture assisting device and see that the suture is positioned in the middle.

BILD 2 / PIC 2

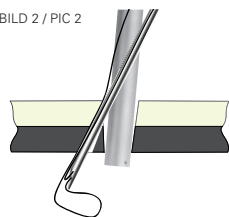

Place the fascia suture needle through the subcutaneous tissue (using the incision for the trocar) in the abdominal wall.

BILD 3 / PIC 3

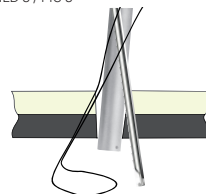

Release the suture from the fascial-suture assisting device and pull back the assisting device. Repeat step 2 (pic.2) on the other side of the trocar and take the loose end of the thread by making use of the catcher of the fascial-suture assisting device.

BILD 4 / PIC 4

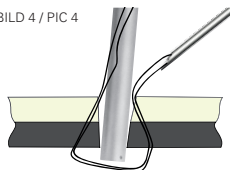

Remove the fascial-suture assisting device with the suture followed by the extraction of the trocar sheath.

BILD 5 / PIC 5

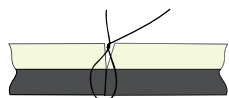

Knot the thread tightly in the subcutaneous tissue. This ensures an easy and safe handling of the abdominal wall closure.

Clip applying forceps Ø 5.0 mm

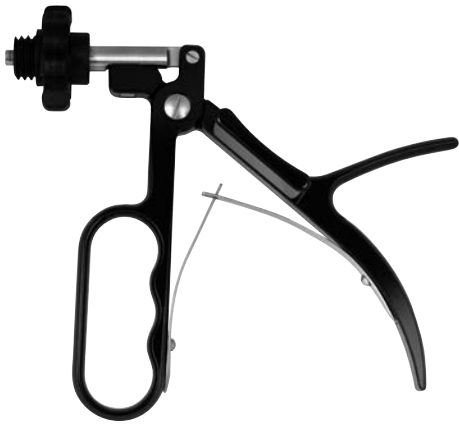

TWS 31048 Ø 5,0 mm

Ergonomical handle for detachable clip applying forceps

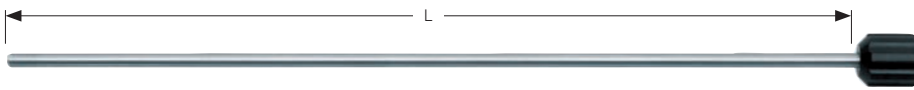

TWS 31049 Ø 5,0 x 330 mm

Shaft for detachable clip applying forceps

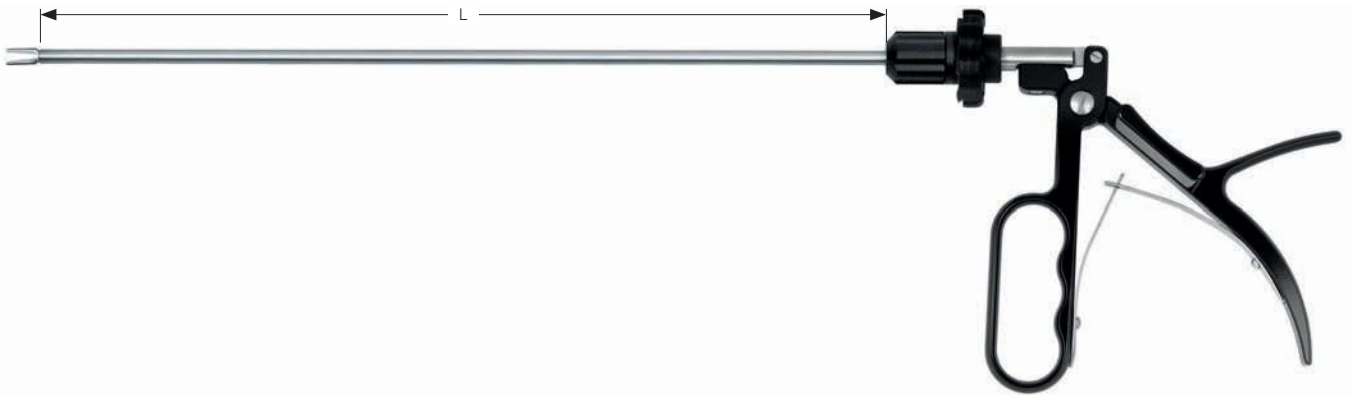



360° rotatable, detachable

Ø 5,0 mm

Insert, only

Complete

Version		Length		
ETHICON	small	330 mm	TWS 31050	TWS 31054C
ETHICON	medium	330 mm	TWS 310522	TWS 31055 C
PILLING, WECK, SLS, HORIZON	small	330 mm	TWS 31051	TWS 31056 C
PILLING, WECK, SLS, HORIZON	medium	330 mm	TWS 31053	TWS 31057 C

Treasure Wright (U.K.) Ltd.

Clip applying forceps Ø 10.0 mm



TW Surgical



TWS 31058 Ø 10,0 mm

Ergonomical handle for detachable clip applying forceps

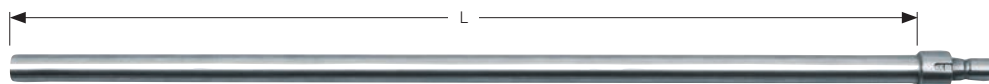

TWS 31059 Ø 10,0 x 330 mm

Shaft for detachable clip applying forceps



for trocars Ø 10.0 mm (Clips: small, medium, medium-large) | Ø 12.5 mm (Clips: large)

360° rotatable, detachable

Ø 10,0 mm

Insert, only

Complete

Version

Length



Version		Length	Insert, only	Complete
ETHICON	small	330 mm	TWS 31060	TWS 31068 C
ETHICON	medium	330 mm	TWS 31061	TWS 31069 C
ETHICON	medium-large	330 mm	TWS 31062	TWS 31070 C
ETHICON	large	330 mm	TWS 31063	TWS 31071 C
PILLING, WECK, SLS, HORIZON	small	330 mm	TWS 31064	TWS 31072 C
PILLING, WECK, SLS, HORIZON	medium	330 mm	TWS 31065	TWS 31073 C
PILLING, WECK, SLS, HORIZON	medium-large	330 mm	TWS 31066	TWS 31074 C
PILLING, WECK, SLS, HORIZON	large	330 mm	TWS 31067	TWS 31075 C

Treasure Wright (U.K.) Ltd.

128-160 City Road, London, EC1V 2NX, United Kingdom
info@twrightmedical.com

Clip applying forceps Ø 10.0 mm, Ligating clips

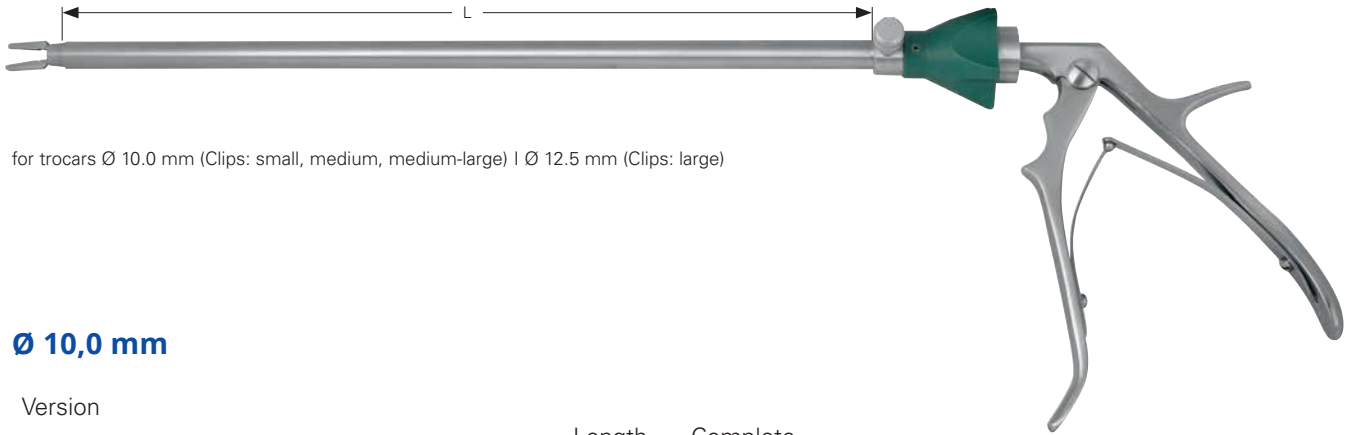

for trocars Ø 10.0 mm (Clips: small, medium, medium-large) | Ø 12.5 mm (Clips: large)

Ø 10,0 mm

Version

Version		Length	Complete
ETHICON	small	330 mm	TWS 31076
ETHICON	medium	330 mm	TWS 31077
ETHICON	medium-large	330 mm	TWS 31078
ETHICON	large	330 mm	TWS 31079
PILLING, WECK, SLS, HORIZON	small	330 mm	TWS 31080
PILLING, WECK, SLS, HORIZON	medium	330 mm	TWS 31081
PILLING, WECK, SLS, HORIZON	medium-large	330 mm	TWS 31082
PILLING, WECK, SLS, HORIZON	large	330 mm	TWS 31083

360° rotatable, LUER-LOCK connection

Ligating clips, Titanium

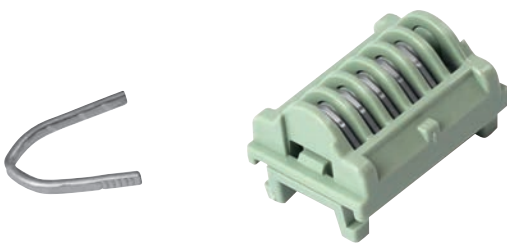

Version	Packaging with	Packaging with
	36 x 6 Stk. pcs.	18 x 6 Stk. pcs.
ETHICON small	TWS 31084 (LT100)	
ETHICON medium	TWS 31085 (LT200)	
ETHICON medium-large		TWS 31086 (LT300)
ETHICON large		TWS 31087 (LT400)

further clips upon request

Treasure Wright (U.K.) Ltd.

128-160 City Road, London, EC1V 2NX, United Kingdom
info@twrightmedical.com

Clip applying forceps, Ligating clips

Clip applying forceps Hem-o-lok®

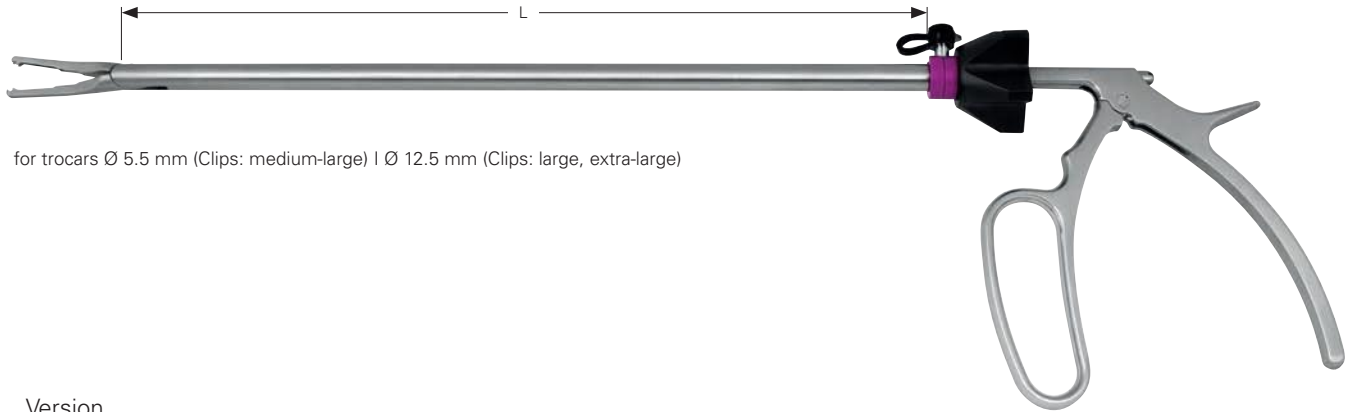

for trocars Ø 5.5 mm (Clips: medium-large) | Ø 12.5 mm (Clips: large, extra-large)

360° rotatable, LUER-LOCK connection

Version

Version	Length	Ø	Item number
Hem-o-lok® Clips medium-large	330 mm	5 mm	TWS 31088
Hem-o-lok® Clips large	330 mm	10 mm	TWS 31089
Hem-o-lok® Clips extra-large	330 mm	10 mm	TWS 31090

Ligating clips, Polymer

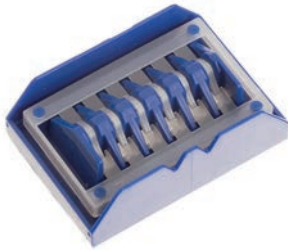

Version

Packaging with
14 x 6 Stk. | pcs.

Hem-o-lok® medium-large	TWS 31091
Hem-o-lok® large	TWS 31092
Hem-o-lok® extra-large	TWS 31093



TW Surgical

Clip applying forceps Ø 10.0 mm for Bulldog clamps

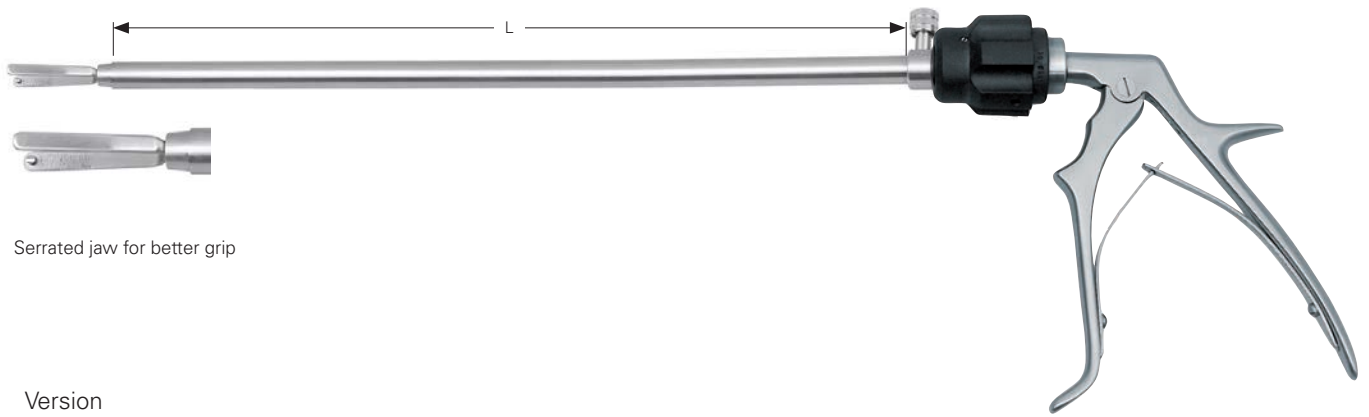

Serrated jaw for better grip

Version	Length	Ø	Item number
Bulldog clamps	330 mm	10 mm	TWS 31094

360° rotatable, LUER-LOCK connection

Bulldog clamps



2 x 3 rows of teeth

DE BAKEY



Item number	Jaw length
TWS 31095	17 mm
TWS 31096	25 mm
TWS 31097	45 mm
TWS 31098	60 mm

straight

DE BAKEY



Item number	Jaw length
TWS 31099	17 mm
TWS 31100	25 mm
TWS 31101	45 mm
TWS 31102	60 mm

curved

DE BAKEY-SATINSKY



Item number	Jaw length
TWS 31103	60 mm

left curved

TWS 31104	60 mm
------------------	-------

right curved

Treasure Wright (U.K.) Ltd.

128-160 City Road, London, EC1V 2NX, United Kingdom
info@twrightmedical.com

Grasping forceps with spring handle



TWS 31105 Ø 5,0 x 330 mm

Grasping forceps, 1 x 2 teeth

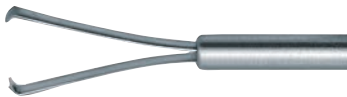

TWS 31106 Ø 5,0 x 330 mm

Grasping forceps, rat tooth



TWS 31107 Ø 5,0 x 330 mm

Grasping forceps, triple jaw



TWS 31108 Ø 5,0 x 330 mm

Grasping forceps, atraumatic

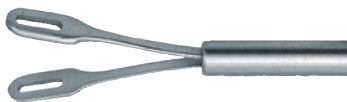

TWS 31109 Ø 5,0 x 330 mm

Grasping forceps, atraumatic, fenestrated



TWS 31120 Ø 5,0 x 330 mm

Grasping forceps, atraumatic, long



TWS 31121 Ø 5,0 x 330 mm

Grasping forceps, atraumatic



TWS 31122 Ø 5,0 x 330 mm

Tissue grasping forceps

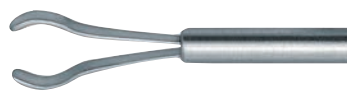

TWS 31123 Ø 5,0 x 330 mm

Tube grasping forceps

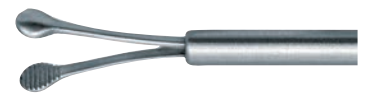

TWS 31124 Ø 5,0 x 330 mm

Bowel grasping forceps



TWS 31127 Ø 5,0 x 330 mm

Grasping forceps, square



TWS 31126 Ø 5,0 x 330 mm

Grasping forceps, T-shape



TWS 31125 Ø 5,0 x 330 mm

Grasping forceps, ball and socket

Grasping forceps with Luer-Lock rinsing channel

Tenaculum forceps, 1 x 1 teeth, double action, handle with french ratchet

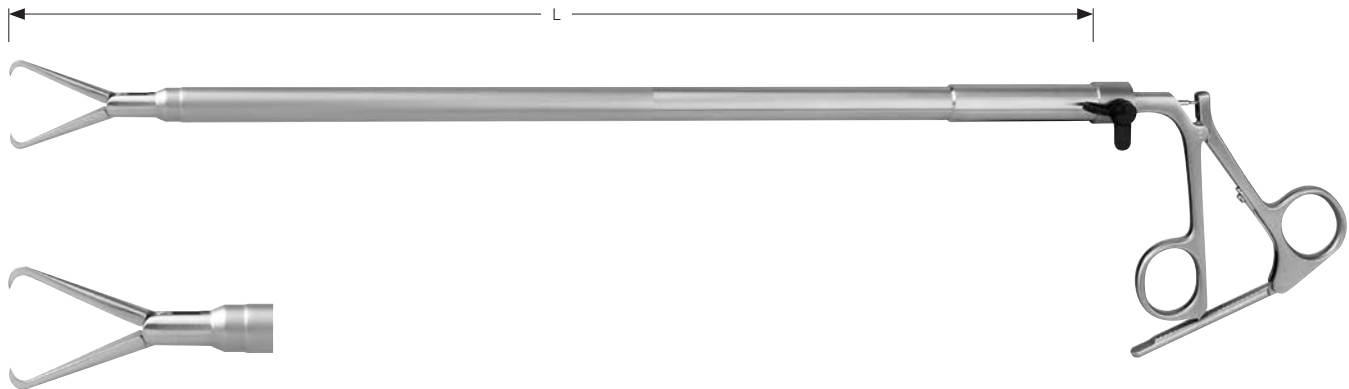

Working length	Ø	Item number
----------------	---	-------------

420 mm	5,0 mm	TWS 31128
420 mm	10,0 mm	TWS 31129
420 mm	13,5 mm	TWS 31130

Claw forceps, 2 x 3 teeth, single action, handle with french ratchet

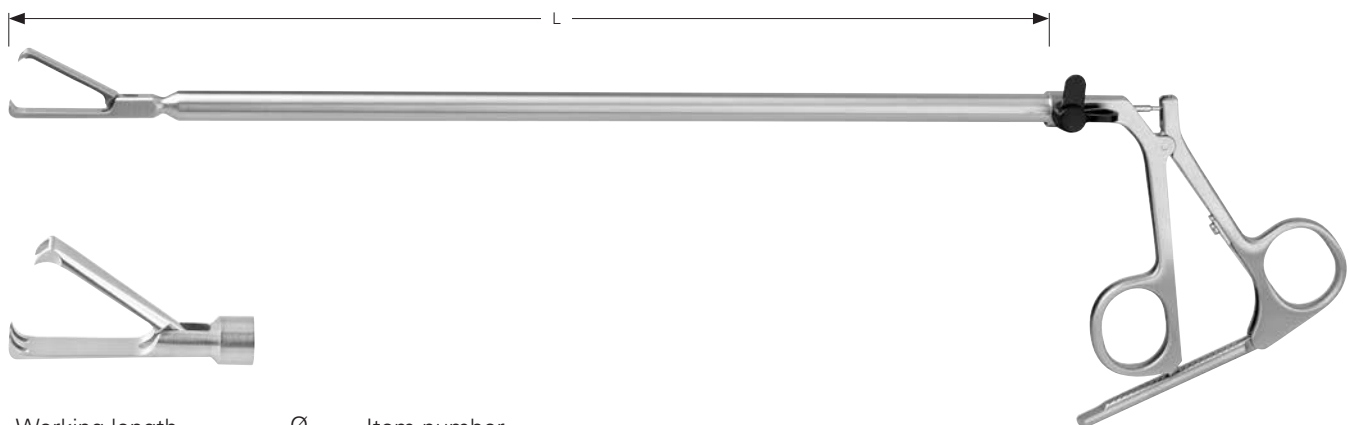

Working length	Ø	Item number
----------------	---	-------------

330 mm	10,0 mm	TWS 31131
420 mm	10,0 mm	TWS 31132

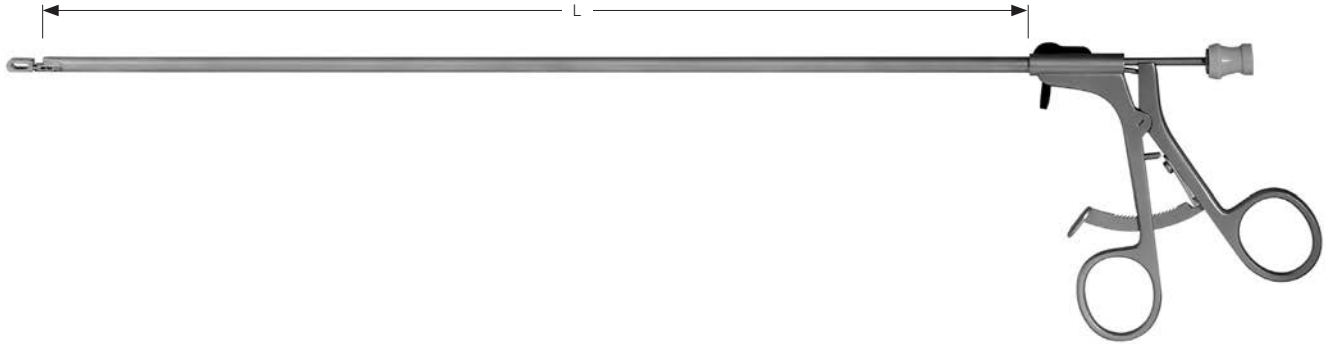

TWS 31133 Ø 5,0 x 330 mm

Cholangiography fixation forceps, instrument channel for 6 Charr. catheter, Luer-Lock-rinsing channel

Bipolar micro coagulation forceps Ø 3.4 mm

Technical advantages of Bipolar coagulation forceps

- 360° rotatable
- Comfortable handling
- Completely detachable, therefore easy to clean
- There is no receding of the jaw when closing. This allows precise grasping and coagulation of the tissue
- Ergonomic design due to new developed ring handle
- Modular design, all parts and electrode inserts are interchangeable
- Autoclavable 134°C / 273°F, 2.3 bar

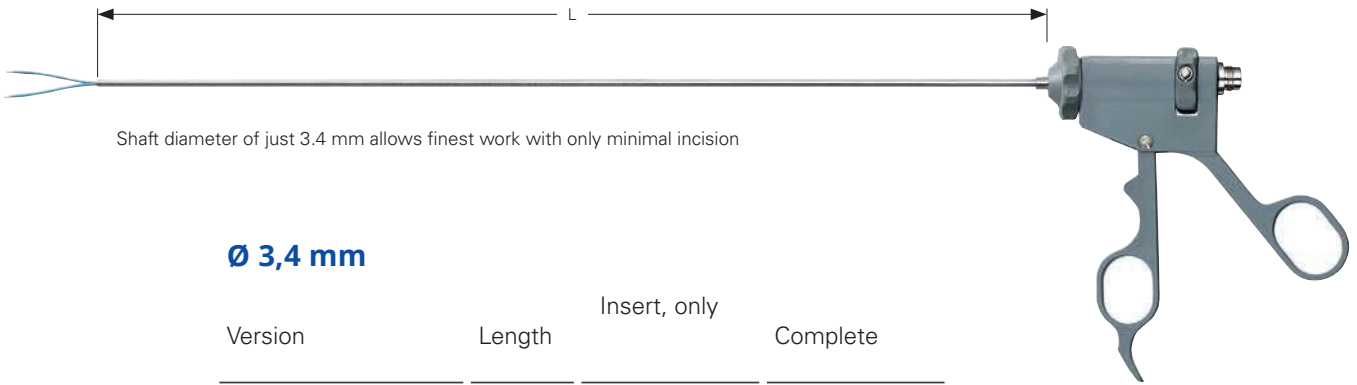

Shaft diameter of just 3.4 mm allows finest work with only minimal incision

Ø 3,4 mm

Version	Length	Insert, only	Complete
 Micro electrode, rippled bar	340 mm	TWS 31134	TWS 31135 C
 Micro electrode, fluted tip 1 mm	340 mm	TWS 31136	TWS 31137 C



TWS 31138

Ring handle for bipolar micro coagulation forceps



TWS 31139 Ø 3,4 x 340 mm





Double shaft for bipolar micro coagulation forceps

Bipolar connecting cables

Bipolar connecting cables for micro coagulation forceps

Plug instrument side



	Length	Item number
	3,0 m	TWS 31140
28,2 mm 	3,0 m	TWS 31141
Ø 7,8 mm 	3,0 m	TWS 31142
Ø 12,3 mm 	3,0 m	TWS 31143

Treasure Wright (U.K.) Ltd.

128-160 City Road, London, EC1V 2NX, United Kingdom
info@twrightmedical.com

Bipolar coagulation forceps Ø 5.0 mm



TW Surgical

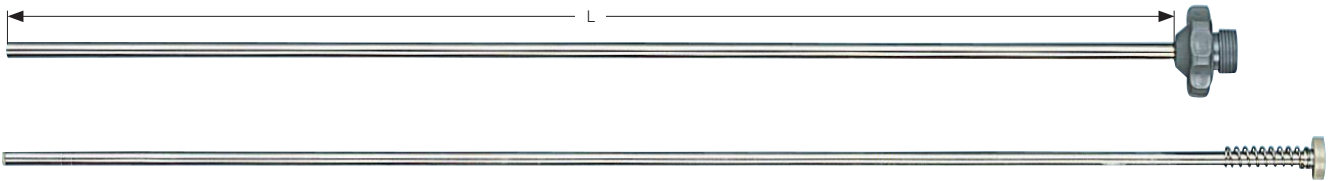

TWS 31144	Ø 5,0 x 200 mm
TWS 31145	Ø 5,0 x 340 mm
TWS 31146	Ø 5,0 x 450 mm

Outer tube for bipolar coagulation forceps

TWS 31147	200 mm
TWS 31148	340 mm
TWS 31149	450 mm

Inner tube for bipolar coagulation forceps



TWS 31151

Ring handle for bipolar coagulation forceps



TWS 31150





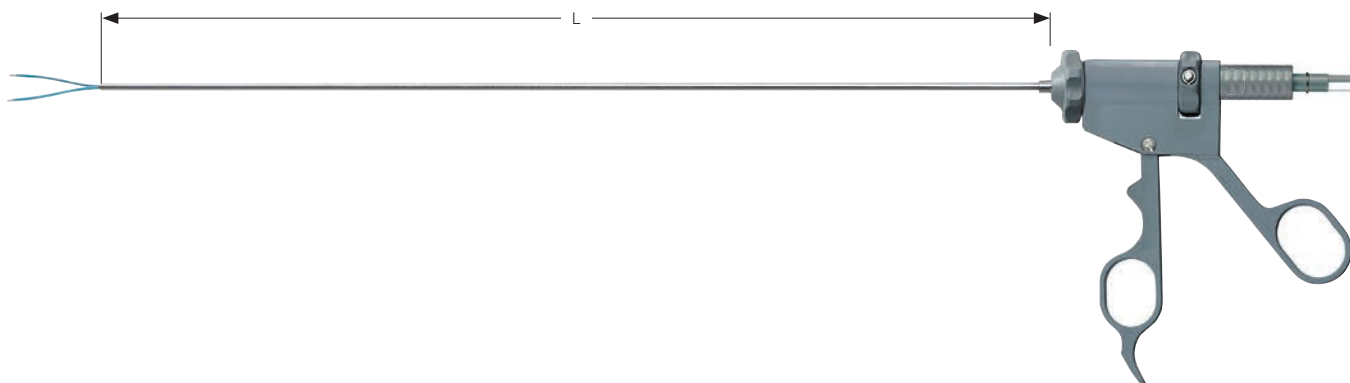

Bipolar adapter with flat plug

Treasure Wright (U.K.) Ltd.

128-160 City Road, London, EC1V 2NX, United Kingdom
info@twrightmedical.com



Ø 5,0 mm

Version	Length	Insert, only	Complete
 Electrode, rippled bar	200 mm	TWS 31153	TWS 31156 C
	340 mm	TWS 31154	TWS 31157 C
	450 mm	TWS 31155	TWS 31158 C
 Electrode, fluted tip 1 mm	200 mm	TWS 31159	TWS 31162 C
	340 mm	TWS 31160	TWS 31163 C
	450 mm	TWS 31161	TWS 31164 C
 KLEPPINGER electrode, serrated	200 mm	TWS 31168	TWS 31165 C
	340 mm	TWS 31169	TWS 31166 C
	450 mm	TWS 31170	TWS 31167 C
 Electrode, tong-type jaw 3 mm	200 mm	TWS 31171	TWS 31181 C
	340 mm	TWS 31172	TWS 31182 C
	450 mm	TWS 31173	TWS 31180 C
 Electrode, scissors, curved	200 mm	TWS 31174	TWS 31179 C
	340 mm	TWS 31175	TWS 31178 C
	450 mm	TWS 31176	TWS 31177 C
 Electrode, TC scissors, curved	200 mm	TWS 31183	TWS 31186 C
	340 mm	TWS 31184	TWS 31187 C
	450 mm	TWS 31185	TWS 31188 C
 Electrode MARYLAND dissector, curved	200 mm	TWS 31189	TWS 31192 C
	340 mm	TWS 31190	TWS 31193 C
	450 mm	TWS 31191	TWS 31194 C

Bipolar connecting cables





Bipolar connecting cables with flat plug

Plug instrument side



Flat plug, square

Flat plug, round

	Length	Item number	
	3,0 m	TWS 31195	TWS 31203
	5,0 m	TWS 31196	TWS 31204
 28,2 mm	3,0 m	TWS 31197	TWS 31205
	5,0 m	TWS 31198	TWS 31206
 Ø 7,8 mm	3,0 m	TWS 31199	TWS 31208
	5,0 m	TWS 31200	TWS 31209
 Ø 12,3 mm	3,0 m	TWS 31201	TWS 31210
	5,0 m	TWS 31202	TWS 31211

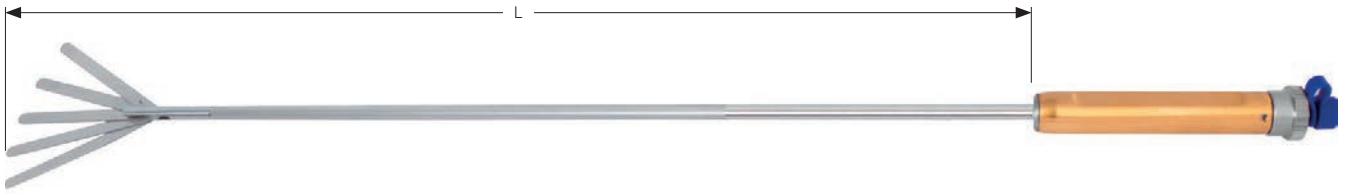

TWS 31214 Ø 5,0 x 340 mm

Fan retractor, 5 fingers, irrigation channel

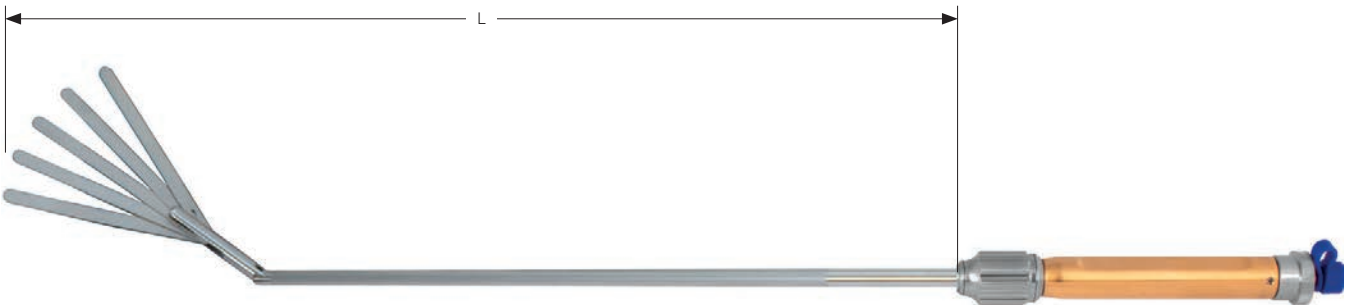

TWS 31211 Ø 5,0 x 340 mm

Fan retractor, 5 fingers, 50° angleable, irrigation channel

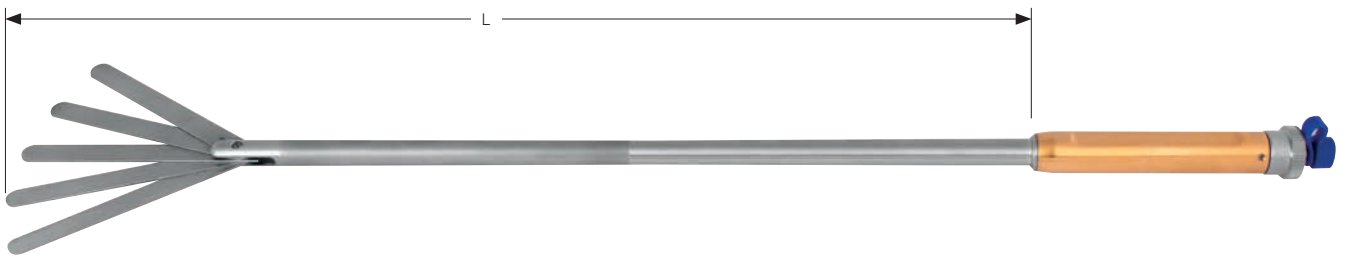

TWS 31213 Ø 10,0 x 340 mm

Fan retractor, 5 fingers, irrigation channel

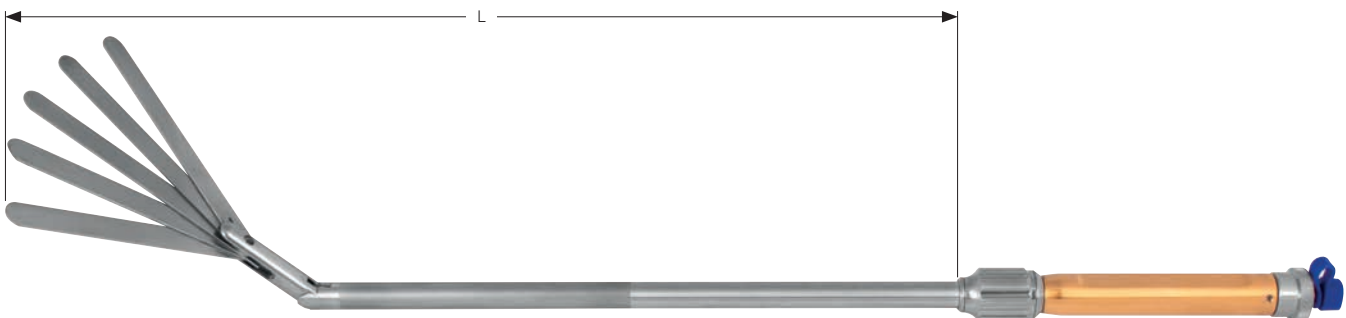

TWS 31215 Ø 10,0 x 340 mm

Fan retractor, 5 fingers, 50° angleable, irrigation channel

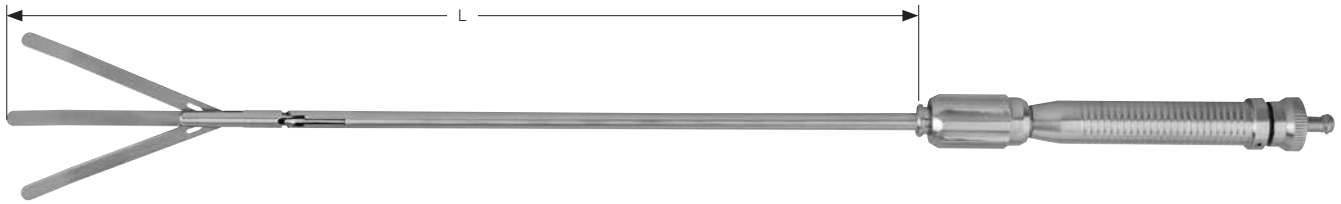

TWS 31216 Ø 5,0 x 330 mm
TWS 31217 Ø 5,0 x 450 mm

Fan retractor, 3 fingers, 60° angleable, irrigation channel, detachable

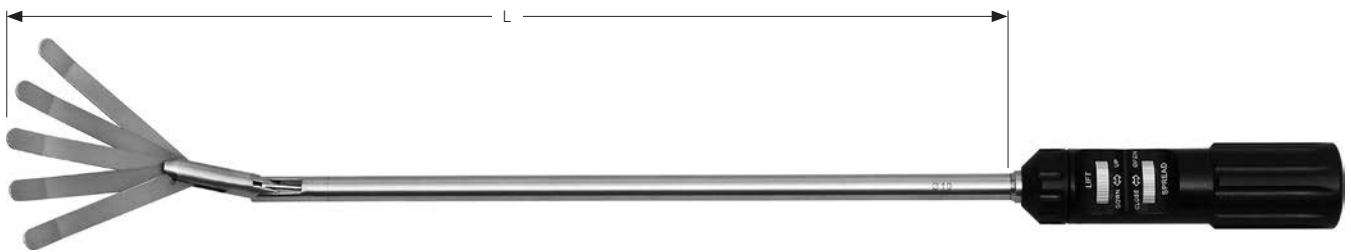

TWS 31218 Ø 10,0 x 380 mm
TWS 31219 Ø 10,0 x 450 mm

Fan retractor, 5 fingers, 80° angleable, detachable

Endo retractors

Endo retractors, angleable, with Luer-Lock irrigation channel

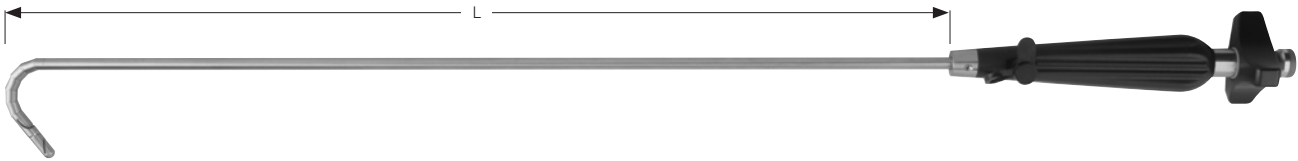

Ø 5,0 mm

TWS 31220 X = 40 mm, L = 380 mm

Finger retractor, 60° angleable



Ø 5,0 mm

TWS 31221 XL X = 40 mm, L = 430 mm

Finger retractor, 90° angleable

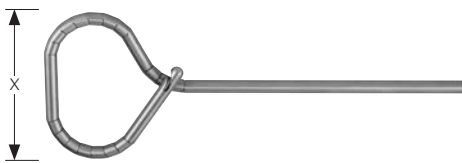

Ø 5,0 mm

TWS 31222 X = 60 mm, L = 380 mm

TWS 31223XL X = 60 mm, L = 450 mm

Triangular retractor

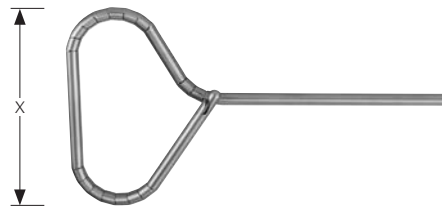

Ø 5,0 mm

TWS 31224 X = 80 mm, L = 380 mm

TWS 31225 XL X = 80 mm, L = 450 mm

Triangular retractor

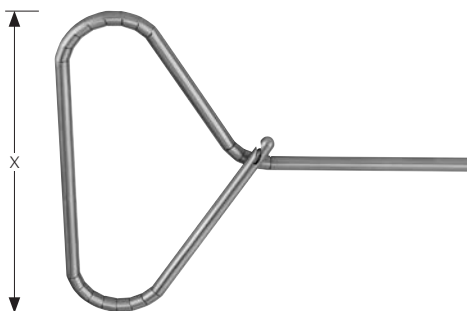

Ø 5,0 mm

TWS 31226 X = 120 mm, L = 380 mm

TWS 31227 XL X = 120 mm, L = 450 mm

Triangular retractor



Ø 5,0 mm

TWS 31228 X = 60 mm, L = 380 mm
TWS 31229 XL X = 60 mm, L = 450 mm

retractor, angled

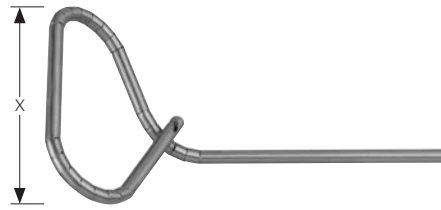

Ø 5,0 mm

TWS 31230 X = 80 mm, L = 380 mm
TWS 31231 XL X = 80 mm, L = 450 mm

retractor, angled



Ø 5,0 mm

TWS 31232 X = 40 mm, L = 380 mm
TWS 31233 XL X = 40 mm, L = 450 mm

Endo retractor, circular



Ø 5,0 mm

TWS 31234 X = 40 mm, L = 380 mm
TWS 31235 XL X = 40 mm, L = 450 mm

retractor, circular, angled



Ø 5,0 mm

TWS 31236 L = 380 mm
TWS 31237 XL L = 450 mm

retractor, hook shaped left, 45° angled downwards



Ø 5,0 mm

TWS 31238 L = 380 mm
TWS 31239 XL L = 450 mm

retractor, hook shaped right, 45° angled downwards



Ø 5,0 mm

TWS 31240 L = 380 mm
TWS 31241 XL L = 450 mm

retractor, hook shaped left, 90° angled downwards



Ø 5,0 mm

TWS 31242 L = 380 mm
TWS 31243 XL L = 450 mm

retractor, hook shaped right, 90° angled downwards



Ø 5,0 mm

Working length

350,0 mm	TWS 31244
450,0 mm	TWS 31245

Esophageal retractor for gastric banding



Ø 10,0 mm

Working length

350,0 mm	TWS 31246
450,0 mm	TWS 31247

Esophageal retractor for gastric banding



TWS 31250

Gallbladder extractor, 3 blades, blade length 70 mm,
90° angled with ratchet, 195 mm

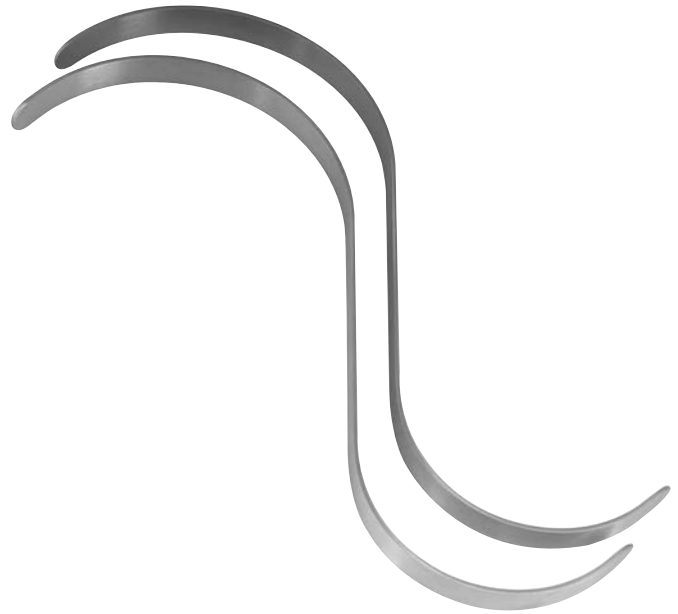

HASSON

TWS 31248 10 mm x 160 mm

TWS 31249 13 mm x 175 mm

„S“ abdominal retractor, malleable, set of 2 pieces

Extraction bags

Tissue extraction bag, sterile, self-opening, latex-free



Volume	Ø-Opening	for trocar	Item number
300,0 ml	70,0 mm	Ø ≥ 10 mm	TWS 31251
550,0 ml	110,0 mm	Ø ≥ 10 mm	TWS 31252
800,0 ml	125,0 mm	Ø ≥ 10 mm	TWS 31253

Volume	Ø-Opening	for trocar	Item number
200,0 ml	50,0 mm	Ø ≥ 10 mm	TWS 31254
400,0 ml	90,0 mm	Ø ≥ 10 mm	TWS 31255
800,0 ml	100,0 mm	Ø ≥ 10 mm	TWS 31256

Controllable, droppable

Clamps with ring handle



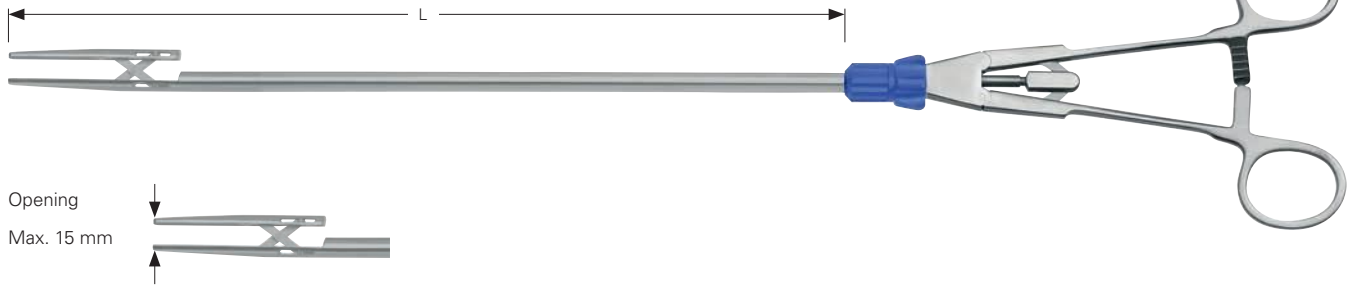

TW Surgical

Laparoscopy clamps, detachable



Ø 10,0 mm

Version	Length	Insert, only	Complete
 DE BAKEY atraumatic clamp	230 mm	TWS 31257	TWS 31258 C
 Atraumatic clamp, cross serrated	230 mm	TWS 31259	TWS 31261 C
 Atraumatic clamp, fenestrated	230 mm	TWS 31260	TWS 31262 C



TWS 31263

Ring handle for laparoscopy clamps



TWS 31264 Ø 10,0

Outer tube for laparoscopy clamps

Treasure Wright (U.K.) Ltd.

128-160 City Road, London, EC1V 2NX, United Kingdom
info@twrightmedical.com



Monopolar electrodes



Monopolar electrodes







Ø 2,8 mm

	Length	Length
Version	250 mm	330 mm
 Button tip electrode	TWS 31266	TWS 31274
 J-Hook electrode	TWS 31265	TWS 31273
 Hook electrode 90°	TWS 31267	TWS 31272
 Spatula electrode	TWS 31268	TWS 31271
 Needle electrode	TWS 31269	TWS 31270

Monopolar electrodes with ergonomic handle



Ø 5,0 mm

	Length	Length
Version	330 mm	450 mm
 Button tip electrode	TWS 31275	TWS 31280
 J-Hook electrode	TWS 31276	TWS 31281
 Hook electrode 90°	TWS 31277	TWS 31282
 Spatula electrode	TWS 31278	TWS 31283
 Needle electrode	TWS 31279	TWS 31284

Treasure Wright (U.K.) Ltd.

128-160 City Road, London, EC1V 2NX, United Kingdom
 info@twrightmedical.com



TWS 31285

J-Hook electrode insert



TWS 31287

Hook electrode insert 90°



TWS 31286

Spatula electrode insert



TWS 31288

Needle electrode insert



TWS 31289

Ball electrode insert



TWS 31290

Knife electrode insert



TWS 31291 Ø 5,0 x 320 mm

TWS 31292 Ø 5,0 x 400 mm

TWS 31293 Ø 5,0 x 450 mm

Handle with shaft for exchangeable electrodes

Monopolar electrodes, Connecting cables

Monopolar electrodes with ceramic insulation, handle Ø 12 mm



TWS 31294 Ø 5,0 x 330 mm

Button electrode



TWS 31296 Ø 5,0 x 330 mm

J-Hook electrode



TWS 31295 Ø 5,0 x 330 mm

Hook electrode 90°



TWS 31297 Ø 5,0 x 330 mm

Spatula electrode

The **dark ceramic** does not reflect light and is therefore optimised for endoscopic applications.

Monopolar connecting cables with round plug



Plug instrument side

	Length	Item number
Ø 4 mm	3,0 m	TWS 31298
	5,0 m	TWS 31299
Ø 5 mm	3,0 m	TWS 31300
	5,0 m	TWS 31301
Ø 8 mm	3,0 m	TWS 31302
	5,0 m	TWS 31303



Treasure Wright (U.K.) Ltd.

128-160 City Road, London, EC1V 2NX, United Kingdom
info@twrightmedical.com

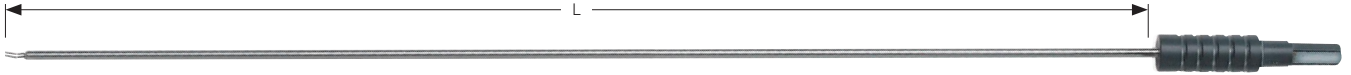
Bipolar electrodes with flat plug connection







Ø 3,0 mm

Version	Length
	340,0 mm
 L-Hook electrode	TWS 31305
 V-Hook electrode	TWS 31305
 Needle electrode	TWS 31306

Bipolar electrodes with flat plug connection



Ø 5,0 mm

Version	Length
	340,0 mm
 J-Hook electrode	TWS 31307
 Hook electrode 90°	TWS 31308
 Spatula electrode	TWS 31309
 Button electrode	TWS 31310

Bipolar connecting cables with flat plug

Plug instrument side



Flat plug, square

Flat plug, round

Length

Item number

		3,0 m	TWS 31311	TWS 31319
		5,0 m	TWS 31312	TWS 31320
28,2 mm		3,0 m	TWS 31313	TWS 31321
		5,0 m	TWS 31314	TWS 31322
Ø 7,8 mm		3,0 m	TWS 31315	TWS 31323
		5,0 m	TWS 31316	TWS 31324
Ø 12,3 mm		3,0 m	TWS 31317	TWS 31325
		5,0 m	TWS 31318	TWS 31326

Uterus manipulator

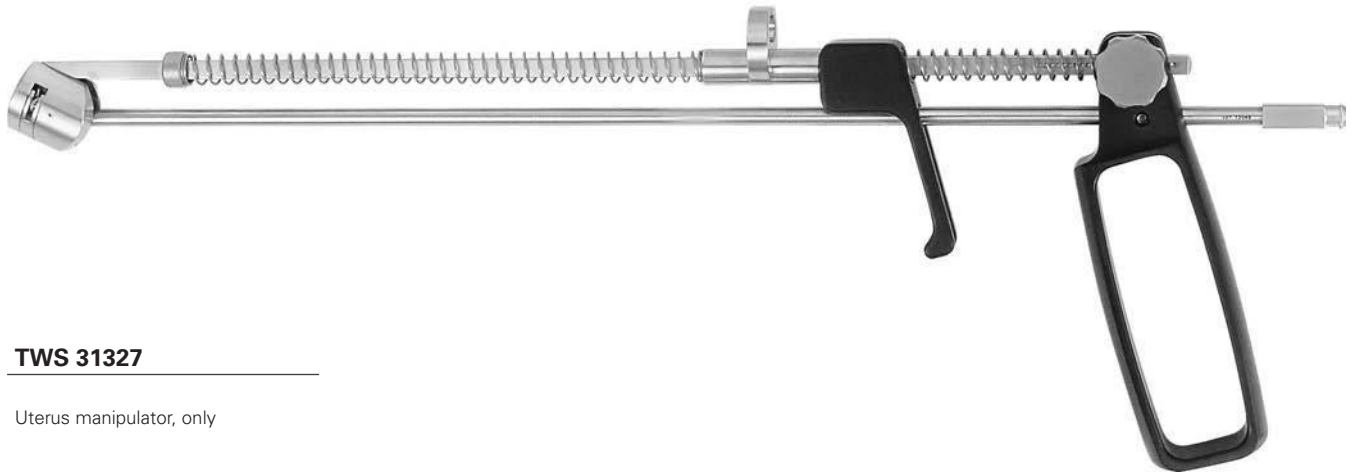

TWS 31327

Uterus manipulator, only

TWS 31328 SET

Uterus manipulator



TWS 31329 Ø 8 x 80 mm

Adapter



TWS 31330 Ø 3 x 45 mm

Adapter



TWS 31331

Adapter with cone, short



TWS 31332 Ø 10 x 100 mm

Adapter



TWS 31333 Ø 3 x 55 mm

Adapter



TWS 31334

Adapter with cone, long

Treasure Wright (U.K.) Ltd.

128-160 City Road, London, EC1V 2NX, United Kingdom
info@twrightmedical.com



TWS 31335 SET

Uterus manipulator



TWS 31336

Universal handle, rotatable



TWS 31337

Shaft with fixation nut



TWS 31338

Inner shaft with locking pin



TWS 31339

Sliding and fixation shaft



TWS 31340

Cervical tenaculum insert



TWS 31341 Ø 4 x 40 mm

TWS 31342 Ø 5 x 50 mm

TWS 31343 Ø 6 x 60 mm

TWS 31344 Ø 7 x 70 mm

TWS 31345 Ø 8 x 80 mm

Intrauterine element with thread



TWS 31346 35 mm

TWS 31347 40 mm

TWS 31348 45 mm

Tube with insulating ring



TWS 31349 Ø 6,1 mm

Adapter for OP-Laparoscope

HD LAP

Länge
Length

Ø

0°

266,3 mm

10,0 mm

TWS 31350

OP-Laparoscope, 90° double angled, instrument channel
Ø 6.0 m



TWS 31351 Ø 6,1 mm

Adapter for OP-Laparoscope

HD LAP

Länge
Length

Ø

0°

266,3 mm

10,0 mm

TWS 31352

OP-Laparoscope, 45° angled, instrument channel
Ø 6.0 m



TWS 31353

Spare sealing cap



TWS 31354

Spare sealing cap for OP-Laparoscopes and Nephroscopes

Ring applicators, Automatic trocar sleeves

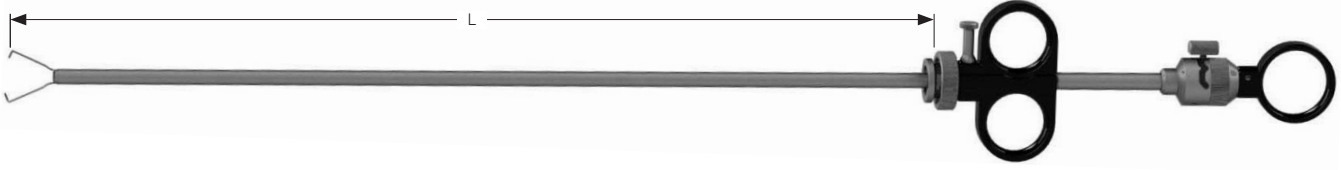

TWS 31355 Ø 6 x 344,5 mm

Ring applicator for single puncture for use with OP-Laparoscope, complete with loading device and cone part



TWS 31356 Ø 6,5 x 300 mm

Ring applicator for double puncture for use with Ø 7.0 mm trocar sleeve, complete with loading device and cone part



TWS 31357

Loading device for ring applicator



TWS 31358

Cone part for ring applicator

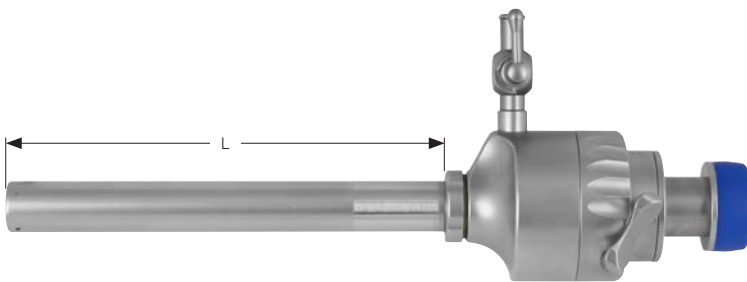

Automatic trocar sleeve with multifunctional valve



Complete with sleeve and conical trocar



Complete with sleeve and pyramidal trocar

Working length	Ø	Sleeve, only	Complete A 	Complete B 
95,0 mm	7,0 mm	TWS 31359	TWS 31363	TWS 31368
97,0 mm	10,0 mm	TWS 31360	TWS 31364	TWS 31369
101,0 mm	11,0 mm	TWS 31361	TWS 31365	TWS 31370
150,0 mm	11,0 mm	TWS 31362 XL	TWS 31366 XL	TWS 31367 XL

XL = for adipose patients



TWS 31371 **TWS 31372**

Adapter, small Adapter, large

COHEN
TWS 31373 SET

Uterine cannula

TWS 31374 Ø 5 x 330 mm
TWS 31375 Ø 5 x 420 mm

Myoma drill

TWS 31376 Ø 10 x 330 mm
TWS 31377 Ø 10 x 420 mm

Myoma drill



TW
Surgical

Treasure Wright (U.K.) Ltd.

**Address: 128-160 , City Road,
London EC1V 2NX. United Kingdom**

www.twrightmedical.com

info@twrightmedical.com



TW Surgical



**UK
CA CE**