



TW
Surgical

MICRO KERRISONS RONGEUR



**UK
CA** **CE**



TW Surgical

Treasure Wright (U.K.) Ltd.











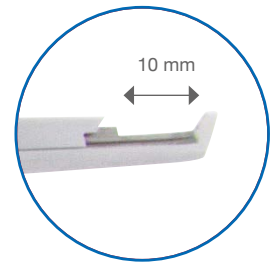





















www.twrightmedical.com



info@twrightmedical.com

KERRISON



	Width of bite	Length of shaft		
		18,0 cm; 7,2"	20,0 cm; 8"	23,0 cm; 9,2"
40°	1 mm	TWS 84-2522/21  	TWS 84-2522/22  	TWS 84-2522/23  
	without ejector			
40°	2 mm	TWS 84-2522/24  	TWS 84-2522/25  	TWS 84-2522/26  
40°	3 mm	TWS 84-2522/27  	TWS 84-2522/28  	TWS 84-2522/29  
40°	4 mm	TWS 84-2522/30  	TWS 84-2522/31  	TWS 84-2522/32  
40°	5 mm	TWS 84-2522/33  	TWS 84-2522/34  	TWS 84-2522/35  
with ejector				

LOVE KERRISON

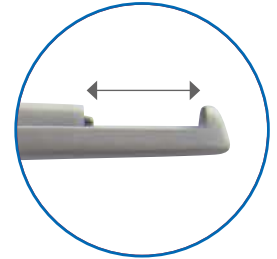

	Width of bite	Length of shaft	
		18,0 cm; 7,2"	20,0 cm; 8"
90°	2 mm	TWS 84-2522/36	TWS 84-2522/37
90°	3 mm	TWS 84-2522/38	TWS 84-2522/39
90°	4 mm	TWS 84-2522/41	TWS 84-2522/40
90°	5 mm	TWS 84-2522/42	TWS 84-2522/43
90°	6 mm	TWS 84-2522/44	TWS 84-2522/45

with ejector

LOVE KERRISON

	Width of bite	Length of shaft		
		18,0 cm; 7,2"	20,0 cm; 8"	23,0 cm; 9,2"
40°	2 mm	TWS 84-2522/48	TWS 84-2522/47	TWS 84-2522/46
40°	3 mm	TWS 84-2522/51	TWS 84-2522/50	TWS 84-2522/49
40°	4 mm	TWS 84-2522/52	TWS 84-2522/53	TWS 84-2522/54
40°	5 mm	TWS 84-2522/55	TWS 84-2522/56	TWS 84-2522/57
40°	6 mm	TWS 84-2522/58	TWS 84-2522/59	TWS 84-2522/60

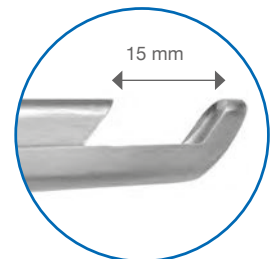

without ejector

LOVE KERRISON

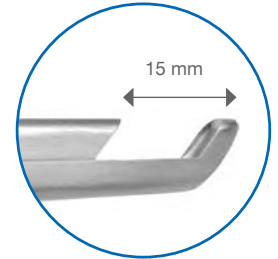

	Width of bite	Length of shaft	
		18,0 cm; 7,2"	20,0 cm; 8"
40°	2 mm	TWS 84-2522/61	TWS 84-2522/66
40°	3 mm	TWS 84-2522/62	TWS 84-2522/67
40°	4 mm	TWS 84-2522/63	TWS 84-2522/68
40°	5 mm	TWS 84-2522/64	TWS 84-2522/69
40°	6 mm	TWS 84-2522/65	TWS 84-2522/70

without ejector

KERRISON MODIFIZ.

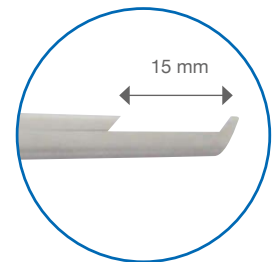

	Width of bite	Length of shaft
		20,0 cm; 8"
40°	2 mm	TWS 84-2522/71  
40°	3 mm	TWS 84-2522/72  
40°	4 mm	TWS 84-2522/73  
40°	5 mm	TWS 84-2522/74  

without ejector

KERRISON

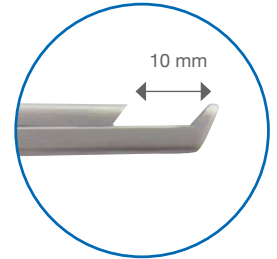

	Width of bite	Length of shaft		
		18,0 cm; 7,2"	20,0 cm; 8"	23,0 cm; 9,2"
40°	1 mm	TWS 84-2522/75 (T CC)	TWS 84-2522/76 (T CC)	TWS 84-2522/77 (T CC)
	without ejector			
40°	2 mm	TWS 84-2522/78 (A T CC)	TWS 84-2522/83 (A T CC)	TWS 84-2522/88 (A T CC)
40°	3 mm	TWS 84-2522/79 (A T CC)	TWS 84-2522/84 (A T CC)	TWS 84-2522/89 (A T CC)
40°	4 mm	TWS 84-2522/80 (A T CC)	TWS 84-2522/85 (A T CC)	TWS 84-2522/90 (A T CC)
40°	5 mm	TWS 84-2522/81 (A T CC)	TWS 84-2522/86 (A T CC)	TWS 84-2522/91 (A T CC)
40°	6 mm	TWS 84-2522/82 (A T CC)	TWS 84-2522/87 (A T CC)	- (A T CC)

KERRISON

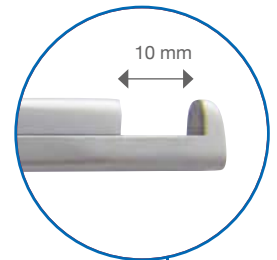

	Width of bite	Length of shaft		
		18,0 cm; 7,2"	20,0 cm; 8"	23,0 cm; 9,2"
90°	1 mm	TWS 84-2522/92 (T CC)	TWS 84-2522/93 (T CC)	-
	without ejector			
90°	2 mm	TWS 84-2522/94 (T CC)	TWS 84-2522/99 (T CC)	TWS 84-2523/04 (T CC)
90°	3 mm	TWS 84-2522/95 (T CC)	TWS 84-2523/00 (T CC)	TWS 84-2523/05 (T CC)
90°	4 mm	TWS 84-2522/96 (T CC)	TWS 84-2523/01 (T CC)	TWS 84-2523/06 (T CC)
90°	5 mm	TWS 84-2522/97 (T CC)	TWS 84-2523/02 (T CC)	TWS 84-2523/07 (T CC)
90°	6 mm	TWS 84-2522/98 (T CC)	TWS 84-2523/03 (T CC)	-
	with ejector			

KERRISON

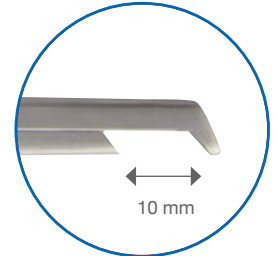

	Width of bite	Length of shaft	
		18,0 cm; 7,2"	20,0 cm; 8"
40°	2 mm	TWS 84-2523/08	-
40°	3 mm	TWS 84-2523/09	TWS 84-2523/13
40°	4 mm	TWS 84-2523/10	TWS 84-2523/14
40°	5 mm	TWS 84-2523/11	TWS 84-2523/15
40°	6 mm	TWS 84-2523/12	-

without ejector

KERRISON

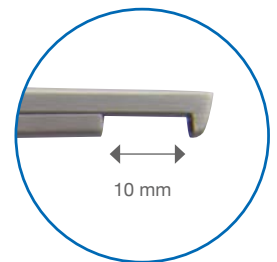

	Width of bite	Length of shaft	
		18,0 cm; 7,2"	20,0 cm; 8"
90°	2 mm	TWS 84-2523/16	TWS 84-2523/21
90°	3 mm	TWS 84-2523/17	TWS 84-2523/22
90°	4 mm	TWS 84-2523/18	TWS 84-2523/23
90°	5 mm	TWS 84-2523/19	TWS 84-2523/24
90°	6 mm	TWS 84-2523/20	TWS 84-2523/25

with ejector

KERRISON

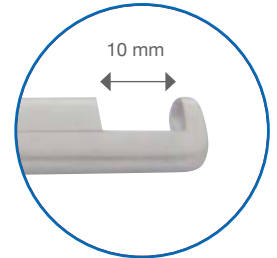

	Width of bite	Length of shaft
		18,0 cm; 7,2"
90°	5 mm	TWS 84-2523/26

with ejector

KERRISON

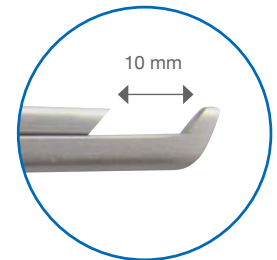

	Width of bite	Length of shaft	
		18,0 cm; 7,2"	20,0 cm; 8"
40°	3 mm	TWS 84-2523/27	TWS 84-2523/29
40°	5 mm	TWS 84-2523/28	TWS 84-2523/30

without ejector

KERRISON

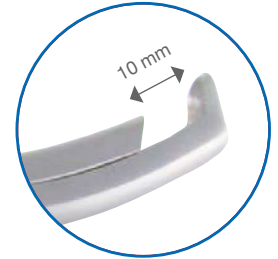







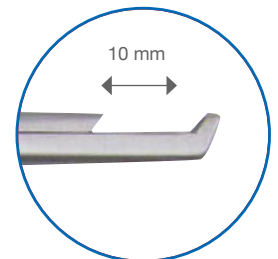

	Width of bite	Length of shaft
		20,0 cm; 8"
40°	2 mm	TWS 84-2523/31
40°	3 mm	TWS 84-2523/32
40°	4 mm	TWS 84-2523/33
40°	5 mm	TWS 84-2523/34

without ejector

BAJONETT







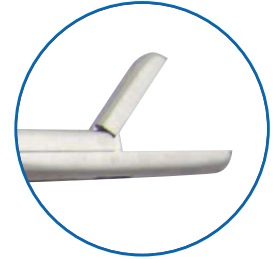

	Width of bite	Length of shaft
		16,0 cm; 6,4"
40°	2 mm	TWS 84-2523/35  
40°	3 mm	TWS 84-2523/36  
40°	4 mm	TWS 84-2523/37  
40°	5 mm	TWS 84-2523/38  



without ejector

BAJONETT



	Width of bite	Length of shaft
		16,0 cm; 6,4"
	2 x 8 mm	TWS 84-2523/39  
	3 x 9 mm	TWS 84-2523/40  
	4 x 10 mm	TWS 84-2523/41  

straight

	Width of bite	Length of shaft
		16,0 cm; 6,4"
	2 x 8 mm	TWS 84-2523/42 
	3 x 9 mm	TWS 84-2523/43 
	4 x 10 mm	TWS 84-2523/44 



angled up

CASPAR



	Width of bite	Length of shaft
		18,5 cm; 7,4"
	2 x 12 mm	TWS 84-2523/45
	3 x 12 mm	TWS 84-2523/46
	4 x 14 mm	TWS 84-2523/47

straight

	Width of bite	Length of shaft
		18,5 cm; 7,4"
	2 x 12 mm	TWS 84-2523/48
	3 x 12 mm	TWS 84-2523/49
	4 x 14 mm	TWS 84-2523/50





angled up

	Width of bite	Length of shaft
		18,5 cm; 7,4"
	2 x 12 mm	TWS 84-2523/51
	3 x 12 mm	TWS 84-2523/52
	4 x 14 mm	TWS 84-2523/53





angled down





Length of shaft	Width of bite			straight
	2 x 10 mm CUSHING	3 x 10 mm LOVE	4 x 10 mm SPURLING	
13,0 cm; 5,2"	TWS 84-2523/54	TWS 84-2523/59	TWS 84-2523/64	
15,0 cm; 6"	TWS 84-2523/55	TWS 84-2523/60	TWS 84-2523/65	
18,0 cm; 7,2"	TWS 84-2523/56	TWS 84-2523/61	TWS 84-2523/66	
23,0 cm; 9,2"	TWS 84-2523/57	TWS 84-2523/62	TWS 84-2523/67	
28,0 cm; 11,2"	TWS 84-2523/58	TWS 84-2523/63	TWS 84-2523/68	
Length of shaft	Width of bite			angled up
	2 x 10 mm CUSHING	3 x 10 mm LOVE-GRÜNWALD	4 x 10 mm SPURLING	
13,0 cm; 5,2"	TWS 84-2523/69	TWS 84-2523/74	TWS 84-2523/79	
15,0 cm; 6"	TWS 84-2523/70	TWS 84-2523/75	TWS 84-2523/80	
18,0 cm; 7,2"	TWS 84-2523/71	TWS 84-2523/76	TWS 84-2523/81	
23,0 cm; 9,2"	TWS 84-2523/72	TWS 84-2523/77	TWS 84-2523/82	
28,0 cm; 11,2"	TWS 84-2523/73	TWS 84-2523/78	TWS 84-2523/83	
Length of shaft	Width of bite			angled down
	2 x 10 mm CUSHING	3 x 10 mm LOVE	4 x 10 mm SPURLING	
13,0 cm; 5,2"	TWS 84-2523/84	TWS 84-2523/89	TWS 84-2523/94	
15,0 cm; 6"	TWS 84-2523/85	TWS 84-2523/90	TWS 84-2523/95	
18,0 cm; 7,2"	TWS 84-2523/86	TWS 84-2523/91	TWS 84-2523/96	
23,0 cm; 9,2"	TWS 84-2523/87	TWS 84-2523/92	TWS 84-2523/97	
28,0 cm; 11,2"	TWS 84-2523/88	TWS 84-2523/93	TWS 84-2523/98	

CASPAR



Width of bite		Length of shaft			straight
		14,0 cm; 5,6"	16,0 cm; 6,4"	18,5 cm; 7,4"	
2 x 12 mm	TWS 84-2523/99	TWS 84-2524/02	TWS 84-2524/08		
3 x 12 mm	TWS 84-2524/00	TWS 84-2524/03	TWS 84-2524/07		
4 x 14 mm	TWS 84-2524/01	TWS 84-2524/04	TWS 84-2524/09		
5 x 14 mm	-	TWS 84-2524/05	TWS 84-2524/10		
6 x 16 mm	-	TWS 84-2524/06	TWS 84-2524/11		
Width of bite		Length of shaft			angled up
		14,0 cm; 5,6"	16,0 cm; 6,4"	18,5 cm; 7,4"	
3 x 12 mm	TWS 84-2524/12	TWS 84-2524/14	TWS 84-2524/17		
4 x 14 mm	TWS 84-2524/13	TWS 84-2524/15	TWS 84-2524/18		
5 x 14 mm	-	TWS 84-2524/16	TWS 84-2524/19		
Width of bite		Length of shaft			angled down
		14,0 cm; 5,6"	16,0 cm; 6,4"	18,5 cm; 7,4"	
3 x 12 mm	TWS 84-2524/20	TWS 84-2524/22	TWS 84-2524/24		
4 x 14 mm	TWS 84-2524/21	TWS 84-2524/23	TWS 84-2524/25		

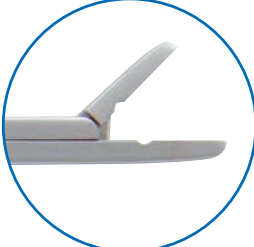

Length of shaft	Width of bite			straight
	2 x 10 mm CUSHING	3 x 10 mm LOVE	4 x 10 mm SPURLING	
13,0 cm; 5,2"	TWS 84-2524/26	TWS 84-2524/31	TWS 84-2524/36	
15,0 cm; 6"	TWS 84-2524/27	TWS 84-2524/32	TWS 84-2524/37	
18,0 cm; 7,2"	TWS 84-2524/28	TWS 84-2524/33	TWS 84-2524/38	
23,0 cm; 9,2"	TWS 84-2524/29	TWS 84-2524/34	TWS 84-2524/39	
28,0 cm; 11,2"	TWS 84-2524/30	TWS 84-2524/35	TWS 84-2524/40	
Length of shaft	Width of bite			angled up
	2 x 10 mm CUSHING	3 x 10 mm	4 x 10 mm SPURLING	
13,0 cm; 5,2"	TWS 84-2524/41	TWS 84-2524/46	TWS 84-2524/51	
15,0 cm; 6"	TWS 84-2524/42	TWS 84-2524/47	TWS 84-2524/52	
18,0 cm; 7,2"	TWS 84-2524/43	TWS 84-2524/48	TWS 84-2524/53	
23,0 cm; 9,2"	TWS 84-2524/44	TWS 84-2524/49	TWS 84-2524/54	
28,0 cm; 11,2"	TWS 84-2524/45	TWS 84-2524/50	TWS 84-2524/55	
Length of shaft	Width of bite			angled down
	2 x 10 mm CUSHING	3 x 10 mm	4 x 10 mm SPURLING	
13,0 cm; 5,2"	TWS 84-2524/56	TWS 84-2524/61	TWS 84-2524/66	
15,0 cm; 6"	TWS 84-2524/57	TWS 84-2524/62	TWS 84-2524/67	
18,0 cm; 7,2"	TWS 84-2524/58	TWS 84-2524/63	TWS 84-2524/68	
23,0 cm; 9,2"	TWS 84-2524/59	TWS 84-2524/64	TWS 84-2524/69	
28,0 cm; 11,2"	TWS 84-2524/60	TWS 84-2524/65	TWS 84-2524/70	



18,0 cm; 7,2"

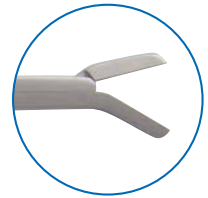
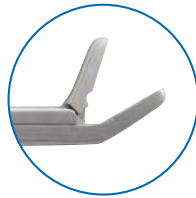

	straight	angled up	angled down
2 x 10 mm CUSHING	TWS 84-2524/72	TWS 84-2524/73	TWS 84-2524/74
3 x 10 mm	TWS 84-2524/75	TWS 84-2524/76	TWS 84-2524/77
4 x 10 mm SPURLING	TWS 84-2524/78	TWS 84-2524/79	TWS 84-2524/80

TWS 84-2524/81 GIGLI

wire saws handle



wire saws

TWS 84-2524/82 30,0 cm; 11 6/8"

TWS 84-2524/83 40,0 cm; 15 6/8"

TWS 84-2524/84 50,0cm; 19 5/8"

TWS 84-2524/85 60,0 cm; 23 5/8"

TWS 84-2524/86 70,0cm; 27 4/8"



TWS 84-2524/87 DE MARTEL

wire saw guide

33,0 cm; 13"



TWS 84-2524/88

with blades TWS 84-2524/89 and TWS 84-2524/90

21,0 cm; 8 2/8"

SET

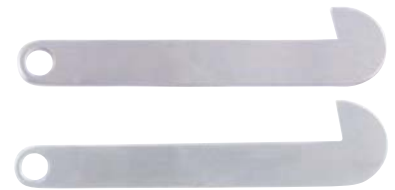

spare blades only

TWS 84-2524/91 Fig. 4



TWS 84-2524/92 Fig. 5



TWS 84-2524/93 DAHLGREEN

with blade TWS 84-2524/94

19,5cm; 7 5/8"

SET



TWS 84-2524/95

spare blade



TWS 84-2524/96 CONE

22,5 cm; 8 7/8"

up to 12 mm



CRUTCHFIELD

TWS 84-2524/97 up to 105 mm



TWS 84-2524/98 **CRUTCHFIELD**

up to 155 mm



drill points

7,0 cm; 2 6/8"

TWS 84-2524/99 Ø 3,5 mm



TWS 84-2525/00 Ø 5,0 mm



TWS 84-2525/01 up to 175 mm



TWS 84-2525/02 Spare pin



LEYLA

TWS 84-2525/03

with 1 arm

SET



TWS 84-2525/04

1 x flexible arm

TWS 84-2525/05

1 x fixation base

TWS 84-2525/06

1 x support

TWS 84-2525/07 **LEYLA**

with 2 arms

SET

TWS 84-2525/08

2 x flexible arms

TWS 84-2525/09

1 x fixation base

TWS 84-2525/10

2 x support

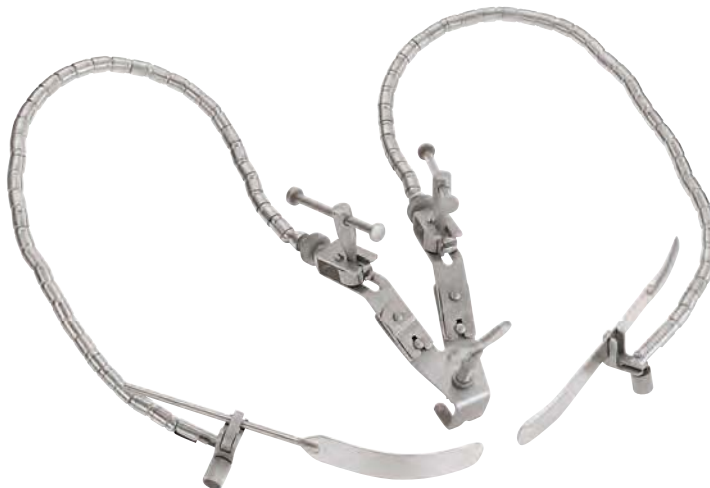

TWS 84-2525/11 LEYLA

with 1 arm

SET

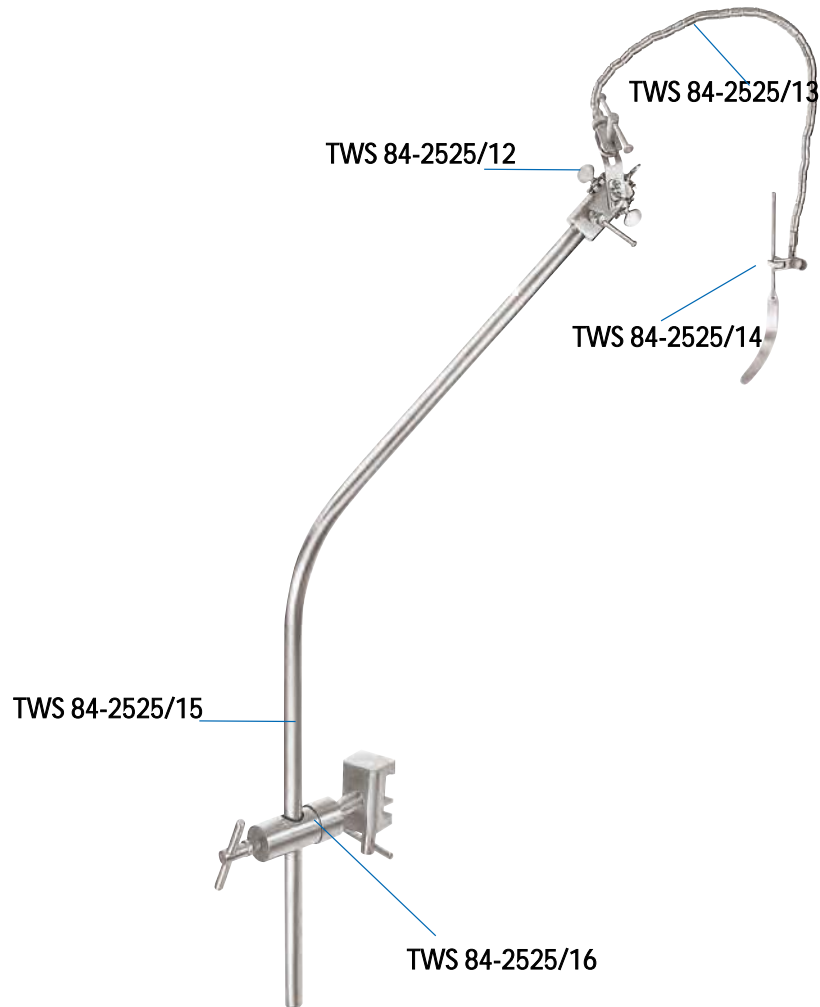

TWS 84-2525/17

1 x ball and socket join

TWS 84-2525/20

1 x holding rod

TWS 84-2525/19

1 x coupling head

TWS 84-2525/18

1 x flexible arm

TWS 84-2525/21

1 x support

TWS 84-2525/22 LEYLA

with 2 arms

SET

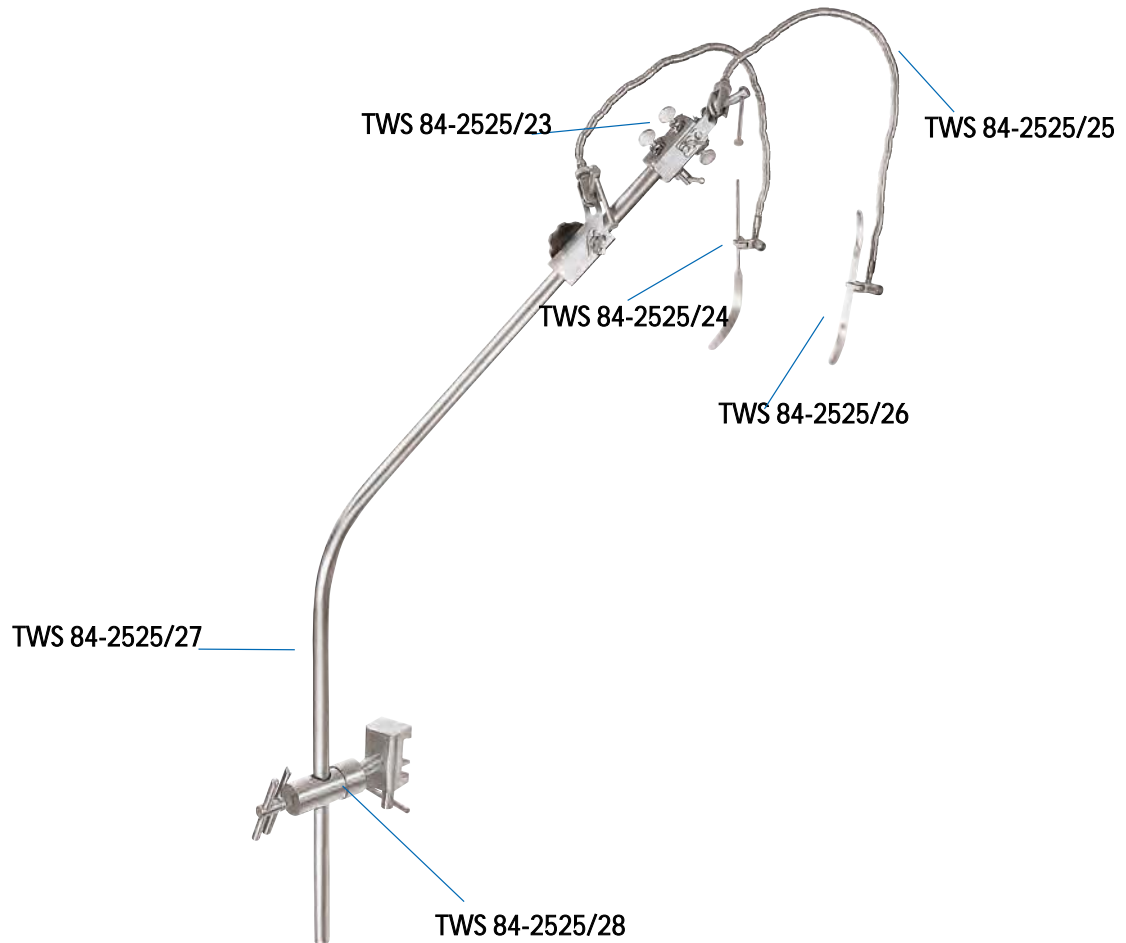

2 x ball and socket join
TWS 84-2525/29

1 x holding rod
TWS 84-2525/31

2 x coupling head
TWS 84-2525/33

2 x flexible arm
TWS 84-2525/30

1 x support
TWS 84-2525/32

1 x support
TWS 84-2525/34

flexible arm
TWS 84-2525/35



fixation base for 1 arm at skull
TWS 84-2525/36



fixation base for 2 arms at skull
TWS 84-2525/37



fixation base for 1 arm at rigid arm
TWS 84-2525/38



holder for brain spatula with round stem
TWS 84-2525/39



holder for flat brain spatula
TWS 84-2525/40



HEIFETZ

20,0 cm; 7 7/8"

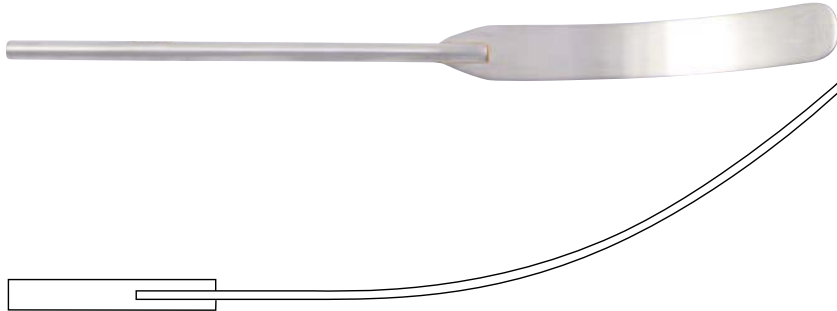

- TWS 84-2525/41 8,0 mm
- TWS 84-2525/42 11,0 mm
- TWS 84-2525/43 14,0 mm
- TWS 84-2525/44 17,0 mm
- TWS 84-2525/45 20,0 mm

HEIFETZ

15,5 cm; 6 1/8"



- TWS 84-2525/46 8,0 mm
- TWS 84-2525/47 11,0 mm
- TWS 84-2525/48 14,0 mm
- TWS 84-2525/49 17,0 mm

OLIVECRONA

18,0 cm; 7"

concave

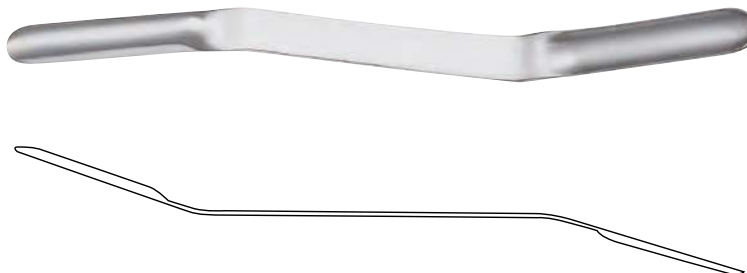

- TWS 84-2525/50 7 + 9 mm
- TWS 84-2525/51 11 + 13 mm
- TWS 84-2525/52 15 + 18 mm
- TWS 84-2525/53 19 + 21 mm

OLIVECRONA

18,0 cm; 7"

convex

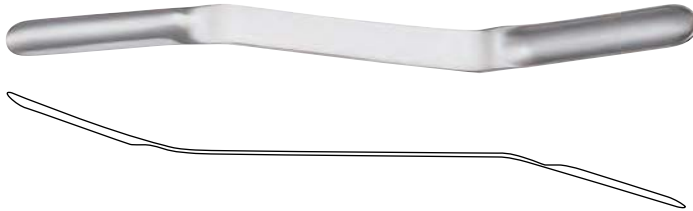

- TWS 84-2525/54 7 + 9 mm
- TWS 84-2525/55 11 + 13 mm
- TWS 84-2525/56 15 + 18 mm
- TWS 84-2525/57 19 + 21 mm

malleable

20,0 cm; 7 7/8"



- TWS 84-2525/58 12,0 mm
- TWS 84-2525/59 17,0 mm

CUSHING

19,5 cm; 7 5/8"

- TWS 84-2525/60 10 + 12 mm

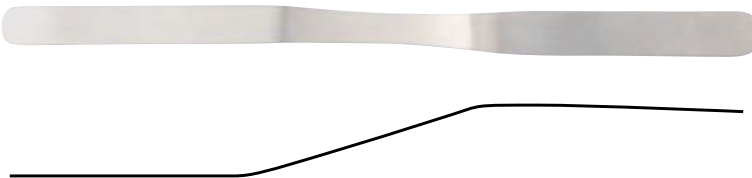

TWS 84-2525/61 HORSLEY

20,0 cm; 7 7/8"

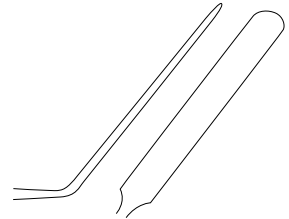

SACHS
TWS 84-2525/62

21,0 cm; 8 2/8"

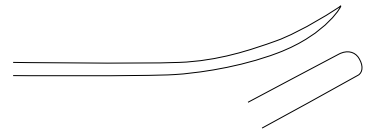

HOLSHER
TWS 84-2525/63

21,0 cm; 8 2/8"

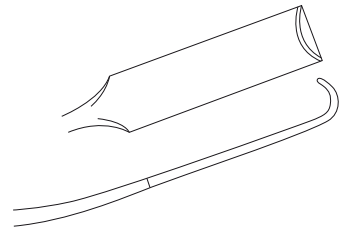

SCOVILLE
TWS 84-2525/64

23,0 cm; 9"
8,0 mm

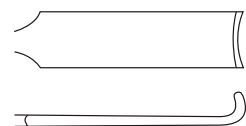

TWS 84-2525/65 LOVE

21,5 cm; 8 4/8"



TWS 84-2525/66 LOVE

17,5 cm; 6 7/8"

45°



TWS 84-2525/67 LOVE

11,0 cm; 4 3/8"

90°



TWS 84-2525/68 LOVE

21,0 cm; 8 2/8"

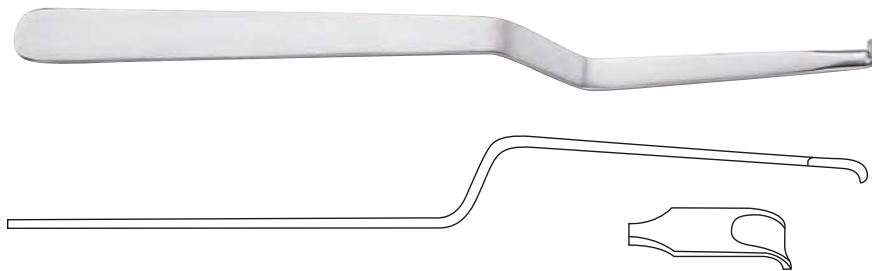

TWS 84-2525/69 SCOVILLE

20,0 cm; 7 7/8"
8,0 mm



TWS 84-2525/70

SMITHWICK

16,5 cm; 6 4/8"



TWS 84-2525/71 **SMITHWICK**

21,0 cm; 8 4/8"



TWS 84-2525/72 **CUSHING**

14,5 cm; 5 6/8"



SACHS

21,0 cm; 8 4/8"



TWS 84-2525/73



TWS 84-2525/74



TWS 84-2525/75 **FRAZIER**

16,5 cm; 6 4/8"

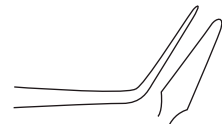

OLIVECRONA



TWS 84-2525/76 **18,0 cm; 7 1/8"**

TWS 84-2525/77

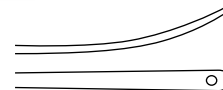

24,0 cm; 9 4/8"

OLIVECRONA



TWS 84-2525/78 **19,5 cm; 7 5/8"**

TWS 84-2525/79

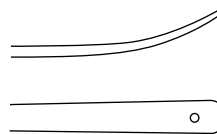

24,0 cm; 9 4/8"

TWS 84-2525/80

MILLIGAN

21,0 cm; 8 4/8"



TWS 84-2525/81

22,0 cm; 8 5/8"



TWS 84-2525/82 **TOENNIS**

24,0 cm; 9 4/8"



TWS 84-2525/83 **DAVIS**

24,5 cm; 9 5/8"



PENFIELD
TWS 84-2525/84

Fig. 1 17,5 cm; 6 7/8"



Fig. 2 19,5 cm; 7 5/8"
TWS 84-2525/85



Fig. 3 19,5 cm; 7 5/8"
TWS 84-2525/86



Fig. 4 20,5 cm; 8 1/8"
TWS 84-2525/87



Fig. 5 18,5 cm; 7 2/8"
TWS 84-2525/88



CASPAR

SET



TWS 84-2525/89 Consisting of:

- TWS 84-2525/90 1 frame
- TWS 84-2525/91 1 key
- TWS 84-2525/92 1 hook 38 mm
- TWS 84-2525/93 1 lateral blade 37 x 22 mm
- TWS 84-2525/94 1 lateral blade 43 x 22 mm
- TWS 84-2525/95 1 lateral blade 47 x 22 mm
- TWS 84-2525/96 1 lateral blade 52 x 22 mm
- TWS 84-2525/97 1 lateral blade 57 x 22 mm

TWS 84-2525/98 **key**



CASPAR
hooks

TWS 84-2525/99 **38,0 mm**



TWS 84-2526/00 **58,0 mm**



CASPAR

TWS 84-2526/01 32 x 22 mm
 TWS 84-2526/02 37 x 22 mm
 TWS 84-2526/03 43 x 22 mm
 TWS 84-2526/04 47 x 22 mm
 TWS 84-2526/05 52 x 22 mm
 TWS 84-2526/06 57 x 22 mm
 TWS 84-2526/07 62 x 22 mm
 TWS 84-2526/08 67 x 22 mm



TWS 84-2526/16 32 x 37 mm
 TWS 84-2526/17 37 x 37 mm
 TWS 84-2526/18 43 x 37 mm
 TWS 84-2526/19 47 x 37 mm
 TWS 84-2526/20 52 x 37 mm
 TWS 84-2526/21 62 x 37 mm
 TWS 84-2526/22 67 x 37 mm



TWS 84-2526/09 32 x 52 mm
 TWS 84-2526/10 37 x 52 mm
 TWS 84-2526/11 43 x 52 mm
 TWS 84-2526/12 47 x 52 mm
 TWS 84-2526/13 52 x 52 mm
 TWS 84-2526/14 62 x 52 mm
 TWS 84-2526/15 67 x 52 mm



CASPAR

SET



TWS 84-2526/23 Consisting of:

- TWS 84-2526/24 1 frame
- TWS 84-2526/25 1 valve medial 40 x 23 mm
- TWS 84-2526/26 1 valve medial 45 x 23 mm
- TWS 84-2526/27 1 valve medial 50 x 23 mm
- TWS 84-2526/28 1 valve medial 55 x 23 mm
- TWS 84-2526/29 1 valve medial 60 x 23 mm
- TWS 84-2526/30 1 valve lateral 40 x 23 mm
- TWS 84-2526/31 1 valve lateral 45 x 23 mm
- TWS 84-2526/32 1 valve lateral 50 x 23 mm
- TWS 84-2526/33 1 valve lateral 55 x 23 mm
- TWS 84-2526/34 1 valve lateral 60 x 23 mm

CASPAR

medial

- TWS 84-2526/35 40 x 23 mm
- TWS 84-2526/36 45 x 23 mm
- TWS 84-2526/37 50 x 23 mm
- TWS 84-2526/38 55 x 23 mm
- TWS 84-2526/39 60 x 23 mm



CASPAR

lateral

- TWS 84-2526/40 40 x 23 mm
- TWS 84-2526/41 45 x 23 mm
- TWS 84-2526/42 50 x 23 mm
- TWS 84-2526/43 55 x 23 mm
- TWS 84-2526/44 60 x 23 mm



CASPAR

blunt

- TWS 84-2526/45 40 x 23 mm
- TWS 84-2526/46 45 x 23 mm
- TWS 84-2526/47 50 x 23 mm
- TWS 84-2526/48 55 x 23 mm
- TWS 84-2526/49 60 x 23 mm
- TWS 84-2526/50 65 x 23 mm



CASPAR

blunt

- TWS 84-2526/51 50 x 25 mm
- TWS 84-2526/52 60 x 25 mm



TWS 84-2526/53 forceps for changing blades

11,5 cm; 4 1/2"



CASPAR

10,5 cm; 4 1/8"

SET



TWS 84-2526/54 Consisting of:

- TWS 84-2526/55 1 spreader
- TWS 84-2526/56 1 valve blunt 45 x 23 mm
- TWS 84-2526/57 1 valve blunt 50 x 23 mm
- TWS 84-2526/58 1 valve blunt 55 x 23 mm
- TWS 84-2526/59 1 valve blunt 60 x 23 mm
- TWS 84-2526/60 1 valve blunt 65 x 23 mm

CASPAR

16,5 cm; 6 1/2"

SET



TWS 84-2526/61 Consisting of:

- TWS 84-2526/62 1 spreader
- TWS 84-2526/63 1 valve blunt 45 x 23 mm
- TWS 84-2526/64 1 valve blunt 50 x 23 mm
- TWS 84-2526/65 1 valve blunt 55 x 23 mm
- TWS 84-2526/66 1 valve blunt 60 x 23 mm
- TWS 84-2526/67 1 valve blunt 65 x 23 mm

CASPAR

15,0 cm; 6"



40 x 18 mm (a x b)
TWS 84-2526/68

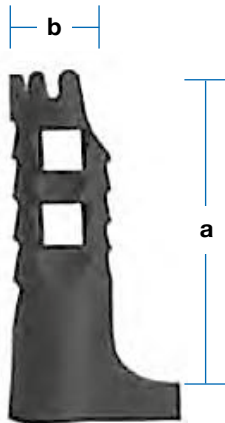

45 x 18 mm
TWS 84-2526/69



50 x 18 mm
TWS 84-2526/70



55 x 18 mm
TWS 84-2526/71



60 x 18 mm
TWS 84-2526/72



CASPAR



SET

TWS 84-2526/74 Consisting of:

- TWS 84-2526/75 1 frame
- TWS 84-2526/76 1 lateral blade 35 x 12 mm
- TWS 84-2526/77 1 lateral blade 40 x 13 mm
- TWS 84-2526/78 1 lateral blade 45 x 13 mm
- TWS 84-2526/79 1 lateral blade 50 x 14 mm
- TWS 84-2526/80 1 lateral blade 55 x 14 mm
- TWS 84-2526/81 1 lateral blade 60 x 15 mm

CASPAR

lateral

- | | |
|---------------------------|---------------------------|
| TWS 84-2526/82 35 x 12 mm | TWS 84-2526/85 50 x 14 mm |
| TWS 84-2526/83 40 x 13 mm | TWS 84-2526/86 55 x 14 mm |
| TWS 84-2526/84 45 x 13 mm | TWS 84-2526/87 60 x 15 mm |



medial

- | | |
|---------------------------|---------------------------|
| TWS 84-2526/91 35 x 12 mm | TWS 84-2526/88 50 x 14 mm |
| TWS 84-2526/92 40 x 13 mm | TWS 84-2526/89 55 x 14 mm |
| TWS 84-2526/93 45 x 13 mm | TWS 84-2526/90 60 x 15 mm |



SCOVILLE



SET

TWS 84-2526/91 Consisting of:

- TWS 84-2526/92 1 frame
- TWS 84-2526/93 1 hooks 50 mm
- TWS 84-2526/94 1 lateral blade 63 x 25 mm

SCOVILLE-HAVERFIELD

with articulated arms



SET

TWS 84-2526/98 Consisting of:

- TWS 84-2526/97 1 frame
- TWS 84-2526/96 1 hook 50 mm
- TWS 84-2526/95 1 lateral blades 63 x 25 mm

SCOVILLE

TWS 84-2526/99 50,0 mm

TWS 84-2527/00 75,0 mm



SCOVILLE

TWS 84-2527/01 50,0 mm

TWS 84-2527/02 75,0 mm



SCOVILLE

TWS 84-2527/03 63 x 25 mm

TWS 84-2527/04 63 x 51 mm

TWS 84-2527/05 67 x 32 mm



TAYLOR

TWS 84-2527/06 47 x 37 mm

TWS 84-2527/07 63 x 51 mm



TWS 84-2527/08 48 x 50 mm

TWS 84-2527/09 64 x 63 mm

TWS 84-2527/10 80 x 57 mm



BADGLEY

52 x 44 mm

TWS 84-2526/82



CLOWARD

25,0 cm; 10"

SET

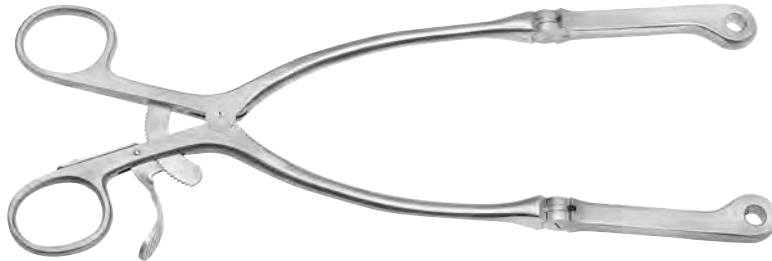

TWS 84-2527/10 Consisting of:

- TWS 84-2527/11 1 spreader
- TWS 84-2527/12 1 lateral valve serrated 40 x 15 - 23 mm
- TWS 84-2527/13 1 lateral valve serrated 45 x 15 - 23 mm
- TWS 84-2527/14 1 lateral valve serrated 50 x 15 - 23 mm
- TWS 84-2527/15 1 lateral valve serrated 55 x 15 - 23 mm
- TWS 84-2527/16 1 lateral valve serrated 60 x 15 - 23 mm



40 x 15 - 23 mm
TWS 84-2527/16



55 x 15 - 23 mm
TWS 84-2527/19



45 x 15 - 23 mm
TWS 84-2527/17



60 x 15 - 23 mm



50 x 15 - 23 mm
TWS 84-2527/18

TWS 84-2527/20

CLOWARD

13,0 cm; 5 1/8"

SET



TWS 84-2527/21 Consisting of:

- TWS 84-2527/22 1 spreader
- TWS 84-2527/23 1 lateral valve blunt 40 x 15 - 23 mm
- TWS 84-2527/24 1 lateral valve blunt 45 x 15 - 23 mm
- TWS 84-2527/25 1 lateral valve blunt 50 x 15 - 23 mm
- TWS 84-2527/26 1 lateral valve blunt 55 x 15 - 23 mm
- TWS 84-2527/27 1 lateral valve blunt 60 x 15 - 23 mm



40 x 15 - 23 mm
TWS 84-2527/28



55 x 15 - 23 mm
TWS 84-2527/31



45 x 15 - 23 mm
TWS 84-2527/29



60 x 15 - 23 mm
TWS 84-2527/32



50 x 15 - 23 mm
TWS 84-2527/30

CLOWARD

TWS 84-2527/33

13,0 cm; 5 1/8"

spreading 18 mm



TWS 84-2527/34 CLOWARD

16,0 cm; 6 2/8"

spreading 18 mm



TWS 84-2527/35 INGE

16,0 cm; 6 2/8"

spreading 35 mm



TWS 84-2527/36 INGE

25,5 cm; 10"

spreading 70 mm



YASARGIL



TWS 84-2527/37	0,6 mm	18,0 cm; 7 1/8"
TWS 84-2527/38	0,6 mm	20,0 cm; 7 7/8"
TWS 84-2527/39	0,6 mm	22,0 cm; 8 5/8"
TWS 84-2527/40	0,6 mm	24,0 cm; 9 4/8"



TWS 84-2527/41	0,9 mm	18,0 cm; 7 1/8"
TWS 84-2527/42	0,9 mm	20,0 cm; 7 7/8"
TWS 84-2527/43	0,9 mm	22,0 cm; 8 5/8"
TWS 84-2527/44	0,9 mm	24,0 cm; 9 4/8"



 1 x 2	18,0 cm; 7 1/8"
---	-----------------



YASARGIL

22,0 cm; 8 5/8"

TWS 84-2527/45	Ø 3,0 mm	
----------------	----------	---

TWS 84-2527/46	Ø 5,0 mm	
----------------	----------	---

YASARGIL-SAMII

24,0 cm; 9 4/8"

TWS 84-2527/47	Ø 3,0 mm	
----------------	----------	---

TWS 84-2527/48	Ø 5,0 mm	
----------------	----------	---

TWS 84-2527/49	Ø 7,0 mm	
----------------	----------	---



YASARGIL

22,0 cm; 8 5/8"

TWS 84-2527/50 Ø 3,0 mm 

TWS 84-2527/51 Ø 5,0 mm 

YASARGIL-SAMII

22,0 cm; 8 5/8"

TWS 84-2527/52 Ø 3,0 mm 

TWS 84-2527/53 Ø 5,0 mm 

SAMII

23,0 cm; 9"



Ø 3,0 mm
TWS 84-2527/54

Ø 4,0 mm
TWS 84-2527/55

Ø 5,0 mm
TWS 84-2527/56

Ø 3,0 mm
TWS 84-2527/57

Ø 4,0 mm
TWS 84-2527/58

Ø 5,0 mm
TWS 84-2527/59

18,5 cm; 7 2/8"



- TWS 84-2527/60 0,3 mm 
- TWS 84-2527/61 0,6 mm 
- TWS 84-2527/62 0,6 mm 



- TWS 84-2527/63 0,3 mm 12,0 cm; 4 6/8"
- TWS 84-2527/64 0,3 mm 15,0 cm; 5 7/8"
- TWS 84-2527/65 0,3 mm 18,0 cm; 7 1/8"
- TWS 84-2527/66 0,3 mm 21,0 cm; 8 2/8"



- TWS 84-2527/67 0,3 mm 12,0 cm; 4 6/8"
- TWS 84-2527/68 0,3 mm 15,0 cm; 5 7/8"
- TWS 84-2527/69 0,3 mm 18,0 cm; 7 1/8"
- TWS 84-2527/70 0,3 mm 21,0 cm; 8 2/8"



- TWS 84-2527/71 0,3 mm 12,0 cm; 4 6/8"
- TWS 84-2527/72 0,3 mm 15,0 cm; 5 7/8"
- TWS 84-2527/73 0,3 mm 18,0 cm; 7 1/8"



 1x2

- TWS 84-2527/74 0,3 mm 12,0 cm; 4,8"
- TWS 84-2527/75 0,3 mm 15,0 cm; 5 7/8"
- TWS 84-2527/76 0,3 mm 18,0 cm; 7 1/8"



 1x2

TWS 84-2527/77

23,0 cm; 9"



0,6 mm

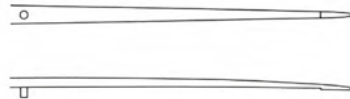

AUSTIN



TWS 84-2527/78 0,8 mm

14,0 cm; 5 4/8"



TWS 84-2527/79 0,8 mm

18,0 cm; 7 1/8"



12,0 cm; 4 6/8"



TWS 84-2527/80

0,3 mm



13,5cm; 5 3/8"



TWS 84-2527/81

WISE

0,3 mm



TWS 84-2527/82 VISE

13,5 cm; 5 3/8

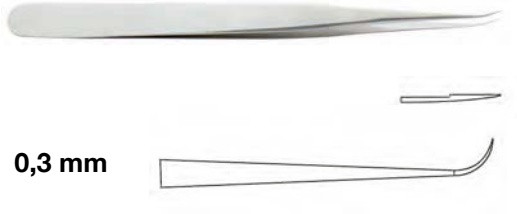

LAZAR

15,5 cm; 6 1/8"



TWS 84-2527/84 0,5 mm



TWS 84-2527/85 0,8mm

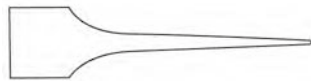

TWS 84-2527/83

18,5 cm; 7 2/8"



0,5 mm

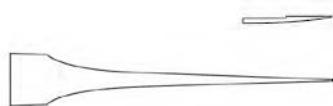

23,0 cm; 9"



TWS 84-2527/86 semi-sharp 

TWS 84-2527/87 blunt 

TWS 84-2527/88 Dissector 

TWS 84-2527/89 Dissector 

TWS 84-2527/90 scoop 

TWS 84-2527/91 scoop 

Fig. 1 Periosteal elevator
TWS 84-2527/92 

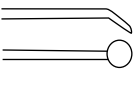
Fig. 2 Periosteal elevator
TWS 84-2527/93 

23,0 cm; 9"



Dissector

TWS 84-2527/94 

TWS 84-2527/95 

Periosteal elevator

TWS 84-2527/96 

CASPAR
exploration hook; insulated

25,0 cm; 10"



TWS 84-2527/97 Fig. 1 

TWS 84-2527/98 Fig. 2 

TWS 84-2527/99 Fig. 3 

TWS 84-2528/00 Fig. 4 

YASARGIL

18,5 cm; 7 2/8"

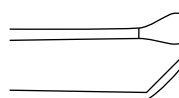

1,0 mm
TWS 84-2528/01 

Ø 4,0 mm
TWS 84-2528/03 

2,5 mm
TWS 84-2528/02 

Ø 2,5 mm
TWS 84-2528/04 

Ø 3,0 mm
TWS 84-2528/05 

YASARGIL

18,5 cm; 7 2/8"



TWS 84-2528/06

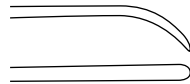

TWS 84-2528/08

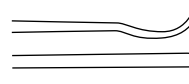

TWS 84-2528/07



TWS 84-2528/09 **YASARGIL**

18,5 cm; 7 2/8"

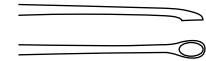

KOOS

18,5 cm; 7 2/8"



TWS 84-2528/10



TWS 84-2528/13

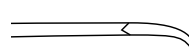

TWS 84-2528/11



TWS 84-2528/14

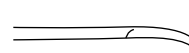

TWS 84-2528/12

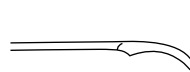

TWS 84-2528/15



YASARGIL

18,5 cm; 7 2/8"



TWS 84-2528/16



TWS 84-2528/17



JACOBSON

18,5 cm; 7 2/8"



TWS 84-2528/18

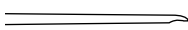

TWS 84-2528/20

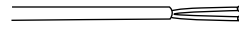

TWS 84-2528/19

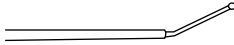

TWS 84-2528/21



YASARGIL

ligature guide and carrier; pointed

18,5 cm; 7 2/8"



Fig. 1

TWS 84-2528/22



Fig. 2

TWS 84-2528/23



Fig. 3

TWS 84-2528/24



Fig. 4

TWS 84-2528/25

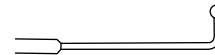

18,5 cm; 7 2/8"

TWS 84-2528/26



Ø 1,5 mm

TWS 84-2528/27 YASARGIL

19,0 cm; 7 4/8"



 Ø 2,2 mm

CASPAR

25,0 cm; 9 7/8"



TWS 84-2528/29 4,0 mm

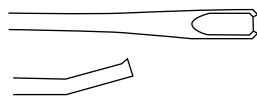

TWS 84-2528/28 5,0 mm

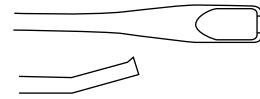

CASPAR



3,0 mm
TWS 84-2528/30

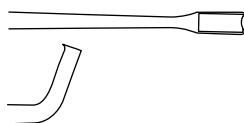

4,0 mm
TWS 84-2528/31

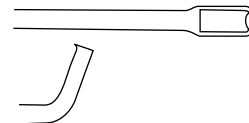

RAY

18,5cm; 7 2/8"

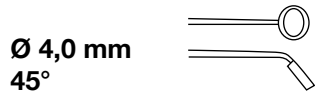

TWS 84-2528/32

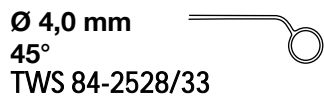

TWS 84-2528/33

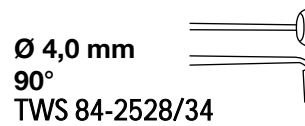

TWS 84-2528/34

HARDY

18,5 cm; 7 2/8"



Ø 4,0 mm; 90°

TWS 84-2528/35

Ø 6,0 mm; 90°

TWS 84-2528/36

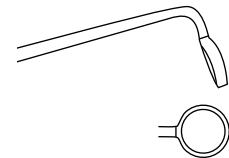

24,5 cm; 9 5/8"



HARDY

TWS 84-2528/37 blunt



TWS 84-2528/38 blunt



TWS 84-2528/39 sharp



TWS 84-2528/40 sharp



HARDY-FAHLBUSCH

TWS 84-2528/41 sharp



TWS 84-2528/42 sharp



TWS 84-2528/43 **HARDY**



MC KENZIE



TWS 84-2528/44 **15,0 cm; 5 7/8"**

TWS 84-2528/45 **19,0 cm; 7 4/8"**



TWS 84-2528/46 **OLIVECRONA-TOENNIS**

14,0 cm; 5 4/8"

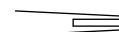

TWS 84-2528/47 **MC KENZIE**
silver clip carrier with clip holding rack



TWS 84-2528/48
silver brain clips in plastic vial; comprising 100 pieces



TWS 84-2528/49

scalp clip in packages of 50 pieces



TWS 84-2528/50 **RANEY**

removal forceps

15,5 cm; 6"



RANEY

TWS 84-2528/51 **scalp clip in packages of 12 pieces**



YASARGIL 7,0 mm



9,0 mm

30,0 cm; 11 6/8"

TWS 84-2528/53 **41,0 cm; 16 1/8"**

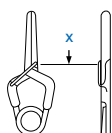

	TWS 84-2528/58	TWS 84-2528/59	TWS 84-2528/60	TWS 84-2528/61	TWS 84-2528/62	TWS 84-2528/63	TWS 84-2528/64
Ti	TWS 84-2528/65	TWS 84-2528/66	TWS 84-2528/67	TWS 84-2528/68	TWS 84-2528/69	TWS 84-2528/70	TWS 84-2528/71
O	6,2 mm	7,0 mm	7,8 mm	9,2 mm	10,6 mm	10,6 mm	11,4 mm
S	150 gms	180 gms	180 gms	200 gms	200 gms	200 gms	200 gms
x =	7 mm	9 mm	11 mm	15 mm	17 mm	20 mm	25 mm

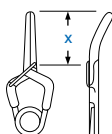

	TWS 84-2528/72	TWS 84-2528/73	TWS 84-2528/74	TWS 84-2528/75	TWS 84-2528/76
Ti	TWS 84-2528/77	TWS 84-2528/78	TWS 84-2528/79	TWS 84-2528/80	TWS 84-2528/81
O	6,0 mm	6,8 mm	7,5 mm	8,7 mm	11,0 mm
S	150 gms	180 gms	180 gms	200 gms	200 gms
x =	7 mm	9 mm	11 mm	15 mm	20 mm



Titanium



Opening of jaws



Closing force

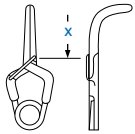

	TWS 84-2528/82	TWS 84-2528/84	TWS 84-2528/86	TWS 84-2528/88	TWS 84-2528/90
Ti	TWS 84-2528/83	TWS 84-2528/85	TWS 84-2528/87	TWS 84-2528/89	TWS 84-2528/91
O	5,5 mm	6,1 mm	6,5 mm	7,4 mm	9,9 mm
S	150 gms	180 gms	180 gms	200 gms	200 gms
x =	7 mm	9 mm	11 mm	15 mm	17 mm

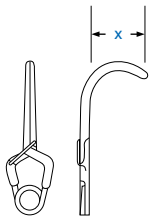

	TWS 84-2528/92	TWS 84-2528/94	TWS 84-2528/96
Ti	TWS 84-2528/93	TWS 84-2528/95	TWS 84-2528/97
O	5,4 mm	5,8 mm	6,2 mm
S	180 gms	180 gms	180 gms
x =	7 mm	9 mm	11 mm



Titanium



Opening of jaws



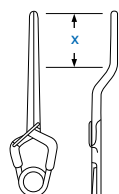

Closing force

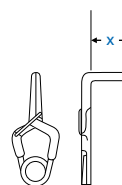
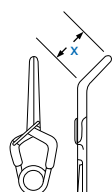

	TWS 84-2528/98	TWS 84-2529/00	TWS 84-2529/02	TWS 84-2529/04	TWS 84-2529/06
Ti	TWS 84-2528/99	TWS 84-2529/01	TWS 84-2529/03	TWS 84-2529/05	TWS 84-2529/07
O	7,9 mm	8,7 mm	10,2 mm	11,9 mm	13,0 mm
S	200 gms	200 gms	200 gms	180 gms	180 gms
x =	7 mm	9 mm	12 mm	17 mm	20 mm

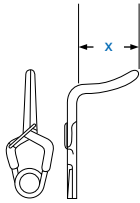
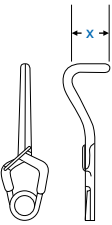
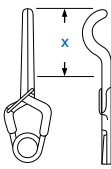

	TWS 84-2529/08	TWS 84-2529/10	TWS 84-2529/12	TWS 84-2529/14	TWS 84-2529/16	TWS 84-2529/18	TWS 84-2529/20
Ti	TWS 84-2529/09	TWS 84-2529/11	TWS 84-2529/13	TWS 84-2529/15	TWS 84-2529/17	TWS 84-2529/19	TWS 84-2529/21
O	6,2 mm	6,5 mm	7,8 mm	8,4 mm	5,6 mm	5,6 mm	5,6 mm
S	200 gms	200 gms	200 gms	200 gms	200 gms	200 gms	200 gms
x =	5 mm	7 mm	9 mm	11 mm	5 mm	7 mm	10 mm

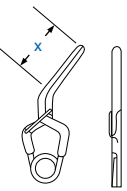
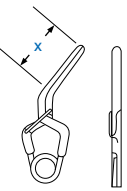
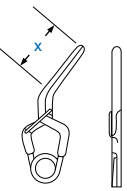
							
	TWS 84-2529/22	TWS 84-2529/23	TWS 84-2529/24	TWS 84-2529/25	TWS 84-2529/26	TWS 84-2529/27	TWS 84-2529/28
Ti	TWS 84-2529/29	TWS 84-2529/30	TWS 84-2529/31	TWS 84-2529/32	TWS 84-2529/33	TWS 84-2529/34	TWS 84-2529/35
O	5,4 mm	5,6 mm	7,2 mm	7,2 mm	8,2 mm	5,7 mm	8,0 mm
S	200 gms	200 gms	200 gms	200 gms	200 gms	200 gms	200 gms
x =	8 mm	10 mm	5 mm	9 mm	11 mm	7 mm	11 mm

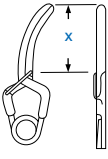
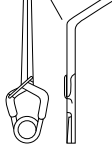
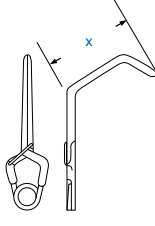
			
	TWS 84-2529/36	TWS 84-2529/37	TWS 84-2529/38
Ti	TWS 84-2529/39	TWS 84-2529/40	TWS 84-2529/41
O	6,2 mm	6,8 mm	7,5 mm
S	200 gms	200 gms	200 gms
x =	9 mm	11 mm	13 mm



Titanium



Opening of jaws



Closing force

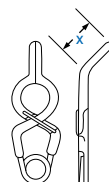
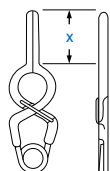

	TWS 84-2529/42	TWS 84-2529/43	TWS 84-2529/44	TWS 84-2529/45	TWS 84-2529/46	TWS 84-2529/47
Ti	TWS 84-2529/48	TWS 84-2529/49	TWS 84-2529/50	TWS 84-2529/51	TWS 84-2529/52	TWS 84-2529/53
O	7,4 mm	8,4 mm	9,6 mm	5,8 mm	6,5 mm	7,2 mm
S	150 gms	150 gms	180 gms	150 gms	150 gms	180 gms
x =	7 mm	9 mm	12 mm	5 mm	7 mm	11 mm

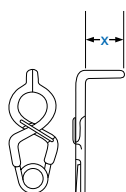

	TWS 84-2529/54	TWS 84-2529/55	TWS 84-2529/56
Ti	TWS 84-2529/57	TWS 84-2529/58	TWS 84-2529/59
O	4,9 mm	4,9 mm	4,9 mm
S	150 gms	150 gms	180 gms
x =	5 mm	7 mm	11 mm

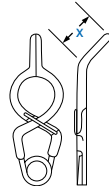
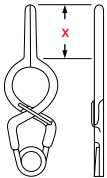

	TWS 84-2529/60	TWS 84-2529/61	TWS 84-2529/62	TWS 84-2529/63	TWS 84-2529/64	TWS 84-2529/65
Ti	TWS 84-2529/66	TWS 84-2529/67	TWS 84-2529/68	TWS 84-2529/69	TWS 84-2529/70	TWS 84-2529/71
O	7,9 mm	9,1 mm	10,3 mm	6,5 mm	7,2 mm	7,8 mm
S	150 gms	150 gms	180 gms	150 gms	150 gms	180 gms
x =	7 mm	9 mm	12 mm	5 mm	7 mm	11 mm

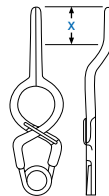
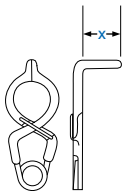

	TWS 84-2529/72	TWS 84-2529/73	TWS 84-2529/74	TWS 84-2529/75	TWS 84-2529/76	TWS 84-2529/77
Ti	TWS 84-2529/78	TWS 84-2529/79	TWS 84-2529/80	TWS 84-2529/81	TWS 84-2529/82	TWS 84-2529/83
O	5,5 mm	5,5 mm	5,5 mm	7,9 mm	8,8 mm	10,0 mm
S	150 gms	150 gms	180 gms	150 gms	150 gms	180 gms
x =	5 mm	7 mm	11 mm	5 mm	7 mm	11 mm



Titanium



Opening of jaws



Closing force

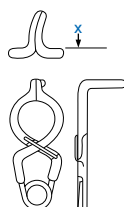
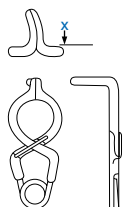

	TWS 84-2529/84	TWS 84-2529/85	TWS 84-2529/86	TWS 84-2529/87	TWS 84-2529/88	TWS 84-2529/89
Ti	TWS 84-2529/90	TWS 84-2529/91	TWS 84-2529/92	TWS 84-2529/93	TWS 84-2529/94	TWS 84-2529/95
O	5,8 mm	5,8 mm	5,8 mm	5,8 mm	5,8 mm	5,8 mm
S	150 gms	150 gms	150 gms	150 gms	150 gms	150 gms
x =	5 mm	7 mm	10 mm	5 mm	7 mm	10 mm

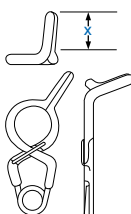
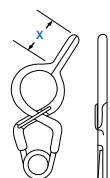

	TWS 84-2529/96	TWS 84-2529/98	TWS 84-2530/00	TWS 84-2530/02	TWS 84-2530/04
Ti	TWS 84-2529/97	TWS 84-2529/99	TWS 84-2530/01	TWS 84-2530/03	TWS 84-2530/05
O	7,0 mm	7,8 mm	8,8 mm	5,8 mm	6,2 mm
S	150 gms	150 gms	150 gms	150 gms	150 gms
x =	5 mm	7 mm	10 mm	5 mm	7 mm

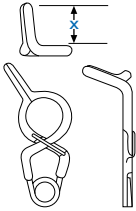
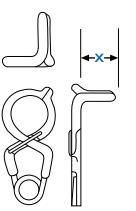
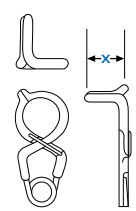
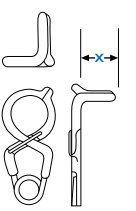
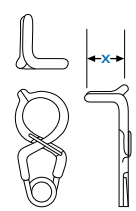
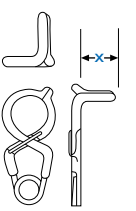
						
	TWS 84-2530/06	TWS 84-2530/07	TWS 84-2530/08	TWS 84-2530/09	TWS 84-2530/10	TWS 84-2530/11
Ti	TWS 84-2530/12	TWS 84-2530/13	TWS 84-2530/14	TWS 84-2530/15	TWS 84-2530/16	TWS 84-2530/17
O	5,8 mm	6,2 mm	5,6 mm	5,6 mm	5,6 mm	5,6 mm
S	150 gms	150 gms	150 gms	150 gms	150 gms	150 gms
x =	5 mm	7 mm	5 mm	7 mm	5 mm	7 mm





Titanium







Opening of jaws



Closing force

							
	TWS 84-2530/18	TWS 84-2530/20	TWS 84-2530/22	TWS 84-2530/23	TWS 84-2530/24	TWS 84-2530/25	TWS 84-2530/26
Ti	TWS 84-2530/19	TWS 84-2530/21	TWS 84-2530/27	TWS 84-2530/28	TWS 84-2530/29	TWS 84-2530/30	TWS 84-2530/31
O	3,3 mm	4,0 mm	3,3 mm	4,0 mm	4,6 mm	3,2 mm	3,8 mm
S	110 gms	110 gms	110 gms	110 gms	110 gms	110 gms	110 gms
x =	3 mm	5 mm	3 mm	5 mm	7 mm	3 mm	4 mm

						
	TWS 84-2530/32	TWS 84-2530/33	TWS 84-2530/34	TWS 84-2530/35	TWS 84-2530/36	TWS 84-2530/37
Ti	TWS 84-2530/38	TWS 84-2530/39	TWS 84-2530/40	TWS 84-2530/41	TWS 84-2530/42	TWS 84-2530/43
O	3,6 mm	3,8 mm	3,6 mm	4,0 mm	4,4 mm	3,6 mm
S	110 gms	110 gms	110 gms	110 gms	110 gms	110 gms
x =	4 mm	5 mm	4 mm	5 mm	7 mm	4 mm

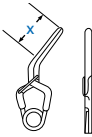
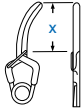
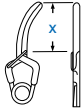
				
	TWS 84-2530/44	TWS 84-2530/46	TWS 84-2530/48	TWS 84-2530/50
Ti	TWS 84-2530/45	TWS 84-2530/47	TWS 84-2530/49	TWS 84-2530/51
O	3,5 mm	4,0 mm	3,5 mm	6,0 mm
S	110 gms	110 gms	130 gms	130 gms
x =	4 mm	5 mm	5 mm	6 mm

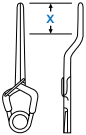
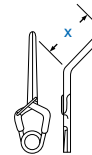
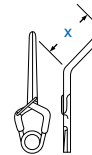
			
	TWS 84-2530/52	TWS 84-2530/53	TWS 84-2530/54
Ti	TWS 84-2530/55	TWS 84-2530/56	TWS 84-2530/57
O	7,0 mm	5,7 mm	4,5 mm
S	130 gms	130 gms	130 gms
x =	4 mm	7 mm	7 mm



Titanium



Opening of jaws



Closing force

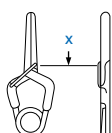

	TWS 84-2530/58	TWS 84-2530/59	TWS 84-2530/60	TWS 84-2530/61	TWS 84-2530/62	TWS 84-2530/63	TWS 84-2530/64
Ti	TWS 84-2530/65	TWS 84-2530/66	TWS 84-2530/67	TWS 84-2530/68	TWS 84-2530/69	TWS 84-2530/70	TWS 84-2530/71
O	6,2 mm	7,0 mm	7,8 mm	9,2 mm	10,6 mm	10,6 mm	11,4 mm
S	110 gms	90 gms	90 gms	90 gms	90 gms	110 gms	110 gms
x =	7 mm	9 mm	11 mm	15 mm	17 mm	20 mm	25 mm

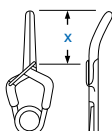

	TWS 84-2530/72	TWS 84-2530/73	TWS 84-2530/74	TWS 84-2530/75	TWS 84-2530/76
Ti	TWS 84-2530/77	TWS 84-2530/78	TWS 84-2530/79	TWS 84-2530/80	TWS 84-2530/81
O	6,0 mm	6,8 mm	7,5 mm	8,7 mm	11,0 mm
S	110 gms	90 gms	90 gms	110 gms	90 gms
x =	7 mm	9 mm	11 mm	15 mm	20 mm

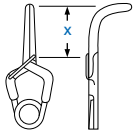

	TWS 84-2530/82	TWS 84-2530/84	TWS 84-2530/86	TWS 84-2530/88	TWS 84-2530/90
Ti	TWS 84-2530/83	TWS 84-2530/85	TWS 84-2530/87	TWS 84-2530/89	TWS 84-2530/91
O	5,5 mm	6,1 mm	6,5 mm	7,4 mm	9,9 mm
S	110 gms	110 gms	110 gms	110 gms	90 gms
x =	7 mm	9 mm	11 mm	15 mm	17 mm

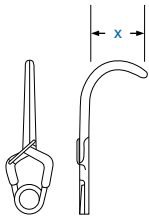

	TWS 84-2530/92	TWS 84-2530/94	TWS 84-2530/96
Ti	TWS 84-2530/93	TWS 84-2530/95	TWS 84-2530/97
O	5,4 mm	5,8 mm	6,2 mm
S	110 gms	110 gms	110 gms
x =	7 mm	9 mm	11 mm



Titanium



Opening of jaws



Closing force

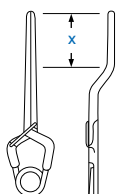

	TWS 84-2530/98	TWS 84-2530/99	TWS 84-2531/00	TWS 84-2531/01	TWS 84-2531/02	TWS 84-2531/03
Ti	TWS 84-2531/04	TWS 84-2531/05	TWS 84-2531/06	TWS 84-2531/07	TWS 84-2531/08	TWS 84-2531/09
O	8,0 mm	7,9 mm	8,7 mm	10,2 mm	11,9 mm	13,0 mm
S	110 gms	90 gms	90 gms	90 gms	90 gms	90 gms
x =	5 mm	7 mm	9 mm	12 mm	17 mm	20 mm

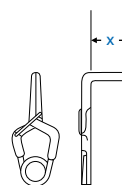
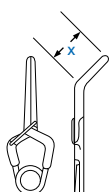

	TWS 84-2531/10	TWS 84-2531/12	TWS 84-2531/14	TWS 84-2531/16	TWS 84-2531/18	TWS 84-2531/20	TWS 84-2531/22
Ti	TWS 84-2531/11	TWS 84-2531/13	TWS 84-2531/15	TWS 84-2531/17	TWS 84-2531/19	TWS 84-2531/21	TWS 84-2531/23
O	6,2 mm	6,5 mm	7,8 mm	8,4 mm	5,6 mm	5,6 mm	5,6 mm
S	110 gms	110 gms	110 gms	110 gms	130 gms	130 gms	130 gms
x =	5 mm	7 mm	9 mm	11 mm	5 mm	7 mm	10 mm

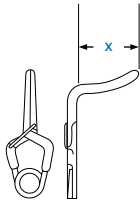
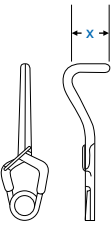
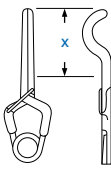
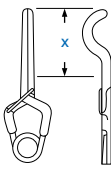
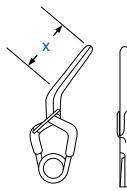
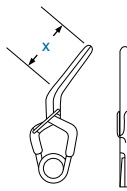
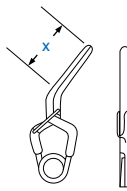
							
	TWS 84-2531/24	TWS 84-2531/26	TWS 84-2531/28	TWS 84-2531/30	TWS 84-2531/32	TWS 84-2531/34	TWS 84-2531/36
Ti	TWS 84-2531/25	TWS 84-2531/27	TWS 84-2531/29	TWS 84-2531/31	TWS 84-2531/33	TWS 84-2531/35	TWS 84-2531/37
O	5,4 mm	5,6 mm	7,2 mm	7,2 mm	8,2 mm	5,7 mm	8,0 mm
S	130 gms	130 gms	90 gms	90 gms	90 gms	90 gms	90 gms
x =	8 mm	10 mm	5 mm	9 mm	11 mm	7 mm	11 mm

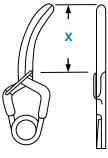
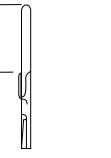
		
	TWS 84-2531/38	TWS 84-2531/39
Ti	TWS 84-2531/40	TWS 84-2531/41
O	6,2 mm	7,5 mm
S	90 gms	90 gms
x =	9 mm	13 mm



Titanium



Opening of jaws



Closing force

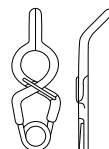
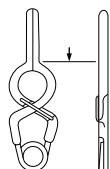

	TWS 84-2531/42	TWS 84-2531/43	TWS 84-2531/44	TWS 84-2531/45	TWS 84-2531/46	TWS 84-2531/47
Ti	TWS 84-2531/48	TWS 84-2531/49	TWS 84-2531/50	TWS 84-2531/51	TWS 84-2531/52	TWS 84-2531/53
O	7,4 mm	8,4 mm	9,6 mm	5,8 mm	6,5 mm	7,2 mm
S	110 gms	110 gms	90 gms	110 gms	110 gms	110 gms
x =	7 mm	9 mm	12 mm	5 mm	7 mm	11 mm

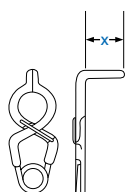

	TWS 84-2531/54	TWS 84-2531/55	TWS 84-2531/56
Ti	TWS 84-2531/57	TWS 84-2531/58	TWS 84-2531/59
O	4,9 mm	4,9 mm	4,9 mm
S	110 gms	110 gms	110 gms
x =	5 mm	7 mm	11 mm

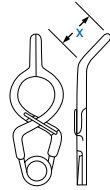
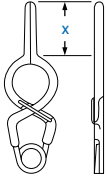

	TWS 84-2531/60	TWS 84-2531/61	TWS 84-2531/62	TWS 84-2531/63	TWS 84-2531/64	TWS 84-2531/65
Ti	TWS 84-2531/66	TWS 84-2531/67	TWS 84-2531/68	TWS 84-2531/69	TWS 84-2531/70	TWS 84-2531/71
O	7,9 mm	9,1 mm	10,3 mm	6,5 mm	7,2 mm	7,8 mm
S	110 gms	100 gms	90 gms	110 gms	110 gms	110 gms
x =	7 mm	9 mm	12 mm	5 mm	7 mm	11 mm

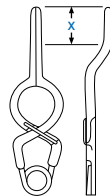
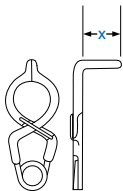

	TWS 84-2531/72	TWS 84-2531/73	TWS 84-2531/74	TWS 84-2531/75	TWS 84-2531/76	TWS 84-2531/77
Ti	TWS 84-2531/78	TWS 84-2531/79	TWS 84-2531/80	TWS 84-2531/81	TWS 84-2531/82	TWS 84-2531/83
O	5,5 mm	5,5 mm	5,5 mm	7,9 mm	8,8 mm	10,0 mm
S	110 gms	110 gms	90 gms	90 gms	90 gms	90 gms
x =	5 mm	7 mm	11 mm	5 mm	7 mm	11 mm



Titanium



Opening of jaws



Closing force

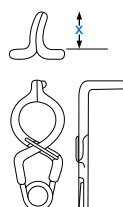
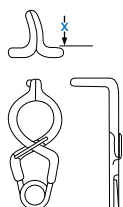

	TWS 84-2531/84	TWS 84-2531/86	TWS 84-2531/88	TWS 84-2531/89	TWS 84-2531/90	TWS 84-2531/91
Ti	TWS 84-2531/85	TWS 84-2531/87	TWS 84-2531/92	TWS 84-2531/93	TWS 84-2531/94	TWS 84-2531/95
O	5,8 mm	5,8 mm	5,8 mm	5,8 mm	5,8 mm	5,8 mm
S	110 gms	110 gms	110 gms	110 gms	110 gms	110 gms
x =	5 mm	7 mm	10 mm	5 mm	7 mm	10 mm

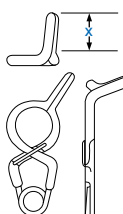
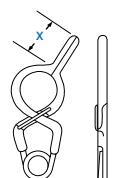

	TWS 84-2531/96	TWS 84-2531/97	TWS 84-2531/98	TWS 84-2531/99	TWS 84-2532/00
Ti	TWS 84-2532/01	TWS 84-2532/02	TWS 84-2532/03	TWS 84-2532/04	TWS 84-2532/05
O	7,0 mm	7,8 mm	8,8 mm	5,8 mm	6,2 mm
S	110 gms	110 gms	110 gms	110 gms	110 gms
x =	5 mm	7 mm	10 mm	5 mm	7 mm

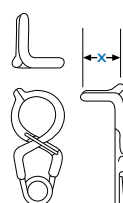
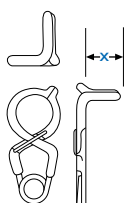
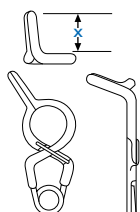

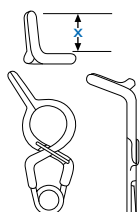
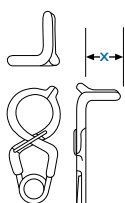
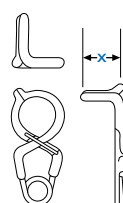
						
	TWS 84-2532/06	TWS 84-2532/08	TWS 84-2532/09	TWS 84-2532/10	TWS 84-2532/11	TWS 84-2532/12
Ti	TWS 84-2532/07	TWS 84-2532/13	TWS 84-2532/14	TWS 84-2532/15	TWS 84-2532/16	TWS 84-2532/17
O	5,8 mm	6,2 mm	5,6 mm	5,6 mm	5,6 mm	5,6 mm
S	110 gms	110 gms	110 gms	110 gms	110 gms	110 gms
x =	5 mm	7 mm	5 mm	7 mm	5 mm	7 mm





Titanium





Opening of jaws



Closing force

							
	TWS 84-2532/18	TWS 84-2532/19	TWS 84-2532/20	TWS 84-2532/21	TWS 84-2532/22	TWS 84-2532/23	TWS 84-2532/24
Ti	TWS 84-2532/25	TWS 84-2532/26	TWS 84-2532/27	TWS 84-2532/28	TWS 84-2532/29	TWS 84-2532/30	TWS 84-2532/31
O	3,3 mm	4,0 mm	3,3 mm	4,0 mm	4,6 mm	3,2 mm	3,8 mm
S	90 gms	70 gms	90 gms	70 gms	70 gms	90 gms	70 gms
x =	3 mm	5 mm	3 mm	5 mm	7 mm	3 mm	4 mm

						
	TWS 84-2532/32	TWS 84-2532/33	TWS 84-2532/34	TWS 84-2532/35	TWS 84-2532/36	TWS 84-2532/37
Ti	TWS 84-2532/38	TWS 84-2532/39	TWS 84-2532/40	TWS 84-2532/41	TWS 84-2532/42	TWS 84-2532/43
O	3,6 mm	3,8 mm	3,6 mm	4,0 mm	4,4 mm	3,6 mm
S	80 gms	70 gms	80 gms	70 gms	70 gms	80 gms
x =	4 mm	5 mm	4 mm	5 mm	7 mm	4 mm

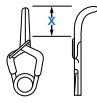
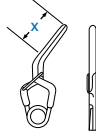
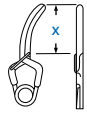
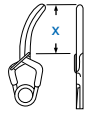
				
	TWS 84-2532/44	TWS 84-2532/45	TWS 84-2532/46	TWS 84-2532/47
Ti	TWS 84-2532/48	TWS 84-2532/49	TWS 84-2532/50	TWS 84-2532/51
O	3,5 mm	4,0 mm	3,5 mm	6,0 mm
S	80 gms	70 gms	70 gms	70 gms
x =	4 mm	5 mm	5 mm	6 mm

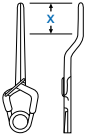
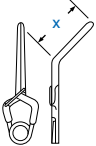
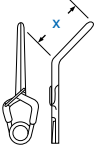
			
	TWS 84-2532/52	TWS 84-2532/53	TWS 84-2532/54
Ti	TWS 84-2532/55	TWS 84-2532/56	TWS 84-2532/57
O	7,0 mm	5,7 mm	4,5 mm
S	70 gms	70 gms	70 gms
x =	4 mm	7 mm	7 mm



Titanium



Opening of jaws



Closing force

YASARGIL



	rigid jaw
	18,0 cm; 7"
MINI	TWS 84-2532/58
STANDARD	TWS 84-2532/59

YASARGIL



	rigid jaw		
	17,0 cm; 6 3/4"	21,0 cm; 8 1/4"	23,0 cm; 9"
MINI	TWS 84-2532/60	TWS 84-2532/61	TWS 84-2532/62
STANDARD	TWS 84-2532/63	TWS 84-2532/64	TWS 84-2532/65

	rotatable jaw	
	21,0 cm; 8 1/4"	23,0 cm; 9"
MINI	TWS 84-2532/66	TWS 84-2532/67
STANDARD	TWS 84-2532/68	TWS 84-2532/69

YASARGIL



		rotatable jaw		
		7,0 cm; 2 3/4"	9,0 cm; 3 1/2"	11,0 cm; 4 1/3"
MINI		TWS 84-2532/70	TWS 84-2532/71	TWS 84-2532/72
		TWS 84-2532/73 Ti	TWS 84-2532/74 Ti	TWS 84-2532/75 Ti
STANDARD		TWS 84-2532/76	TWS 84-2532/77	TWS 84-2532/78
		TWS 84-2532/79 Ti	TWS 84-2532/80 Ti	TWS 84-2532/81 Ti

YASARGIL



		rigid jaw			
		7,0 cm; 2 3/4"	9,0 cm; 3 1/2"	11,0 cm; 4 1/3"	13,0 cm; 5 1/8"
MINI		TWS 84-2532/82	TWS 84-2532/83	TWS 84-2532/84	TWS 84-2532/85
		TWS 84-2532/86 Ti	TWS 84-2532/89 Ti	TWS 84-2532/92 Ti	TWS 84-2532/95 Ti
STANDARD		TWS 84-2532/87	TWS 84-2532/90	TWS 84-2532/93	TWS 84-2532/96
		TWS 84-2532/88 Ti	TWS 84-2532/91 Ti	TWS 84-2532/94 Ti	TWS 84-2532/97 Ti

		rotatable jaw			
		7,0 cm; 2 3/4"	9,0 cm; 3 1/2"	11,0 cm; 4 1/3"	13,0 cm; 5 1/8"
MINI		TWS 84-2532/98	TWS 84-2532/99	TWS 84-2533/00	TWS 84-2533/01
		TWS 84-2533/02 Ti	TWS 84-2533/05 Ti	TWS 84-2533/08 Ti	TWS 84-2533/11
STANDARD		TWS 84-2533/03	TWS 84-2533/06	TWS 84-2533/09	TWS 84-2533/12
		TWS 84-2533/04 Ti	TWS 84-2533/07 Ti	TWS 84-2533/10 Ti	TWS 84-2533/13

KERRISON SWING

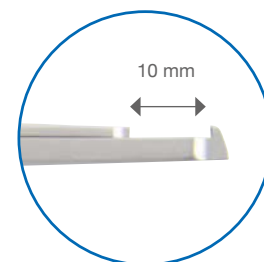

		Length of shaft		
Width of bite		18,0 cm; 7,2"	20,0 cm; 8"	23,0 cm; 9,2"
90°	1 mm	TWS 84-2533/14 T CC	TWS 84-2533/15 T CC	TWS 84-2533/16 T CC

without ejector

		Length of shaft		
Width of bite		18,0 cm; 7,2"	20,0 cm; 8"	23,0 cm; 9,2"
90°	2 mm	TWS 84-2533/16 T CC	TWS 84-2533/20 T CC	TWS 84-2533/25 T CC
90°	3 mm	TWS 84-2533/17 T CC	TWS 84-2533/21 T CC	TWS 84-2533/26 T CC
90°	4 mm	TWS 84-2533/18 T CC	TWS 84-2533/22 T CC	TWS 84-2533/27 T CC
90°	5 mm	TWS 84-2533/19 T CC	TWS 84-2533/23 T CC	TWS 84-2533/28 T CC
90°	6 mm	TWS 84-2533/30 T CC	TWS 84-2533/24 T CC	TWS 84-2533/29 T CC

with ejector



KERRISON

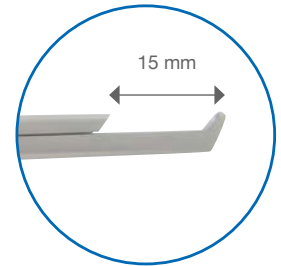

	Width of bite	Length of shaft		
		18,0 cm; 7,2"	20,0 cm; 8"	23,0 cm; 9,2"
40°	1 mm	TWS 84-2533/31 <small>T CC</small>	TWS 84-2533/37 <small>T CC</small>	TWS 84-2533/43 <small>T CC</small>
40°	2 mm	TWS 84-2533/32 <small>A T CC</small>	TWS 84-2533/38 <small>A T CC</small>	TWS 84-2533/44 <small>A T CC</small>
40°	3 mm	TWS 84-2533/33 <small>A T CC</small>	TWS 84-2533/39 <small>A T CC</small>	TWS 84-2533/45 <small>A T CC</small>
40°	4 mm	TWS 84-2533/34 <small>A T CC</small>	TWS 84-2533/40 <small>A T CC</small>	TWS 84-2533/46 <small>A T CC</small>
40°	5 mm	TWS 84-2533/35 <small>A T CC</small>	TWS 84-2533/41 <small>A T CC</small>	TWS 84-2533/47 <small>A T CC</small>
40°	6 mm	TWS 84-2533/36 <small>A T CC</small>	TWS 84-2533/42 <small>A T CC</small>	TWS 84-2533/48 <small>A T CC</small>

KERRISON



	Width of bite	Length of shaft
		20,0 cm; 8"
40°	2 mm	TWS 84-2533/49 
40°	3 mm	TWS 84-2533/50 
40°	4 mm	TWS 84-2533/51 
40°	5 mm	TWS 84-2533/52 

without ejector



TW
Surgical

Treasure Wright (U.K.) Ltd.

**Address: 128-160 , City Road,
London EC1V 2NX. United Kingdom**

www.twrightmedical.com

info@twrightmedical.com



TW Surgical



**UK
CA CE**