



TW
Surgical

SPINAL RONGEURS AND PUNCHES



**UK
CA CE**



TW Surgical

Treasure Wright (U.K.) Ltd.



www.twrightmedical.com



info@twrightmedical.com



TW Surgical

SPINAL RONGEURS AND PUNCHES

IDENTIFICATION CHART

SHAFT LENGTH

Measured in closed position



BITE STYLES

Punch jaws, thin footplate

Forward 40°

Up 90°

Down 90°

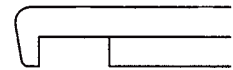
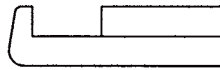

BITE STYLES

Punch jaws, regular footplate

Forward 40°

Up 90°

Down 90°

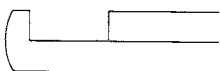
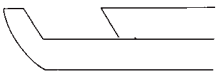

BITE STYLES

Cup jaws

Straight

Up

Down



BITE STYLES

Footplate

Bite opening

Bite size

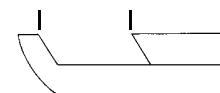
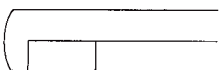

SPINAL RONGEURS AND PUNCHES

HANDLE STYLES



Style I
Ring handle
Handle height: 4" (102mm)



Style II
Kerrison handle
Handle height: 6 1/4" (159mm)



Style III
Love-Kerrison handle
(Cherry)
Handle height: 6" (152mm)



Style IV
Large Kerrison handle
Handle height: 6 1/4" (159mm)



TW Surgical

SPINAL RONGEURS AND PUNCHES

HANDLE STYLES



Style V
Small Kerrison Handle
Handle height: 5"



Style VI
Ferris-Smith
Kerrison Ring Handle
Handle height: 5"



Style VII
Spurling Kerrison Handle
Wider grip improves comfort and control.
Handle height: 4 3/4"



Style VIII
Medium Kerrison Handle
Handle height: 5 1/4"



TW Surgical

SPINAL IVD RONGEURS

INTERVERTEBRAL DISC RONGEUR (HANDLE STYLE I)



Straight

Up angle 45°

Down angle 45°



Cushing
1.5x10mm
bite straight

TWS 84-2034/14

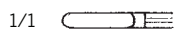

Cushing
2x10 mm
bite straight

TWS 84-2034/15 5"
TWS 84-2034/16 7"
TWS 84-2034/17 9"

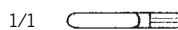

Cushing
2x10 mm
bite up angle 45°

TWS 84-2034/18 5"
TWS 84-2034/19 7"
TWS 84-2034/20 2 9"



Cushing
2x10 mm
bite down angle 45°

TWS 84-2034/21 5"
TWS 84-2034/22 7"
TWS 84-2034/23 9"



Love-Gruenwald
3x10 mm
bite straight

TWS 84-2034/24 5"
TWS 84-2034/25 7"



Love-Gruenwald
3x10 mm
bite up angle 45°

TWS 84-2034/26 5"
TWS 84-2034/27 7"



Love-Gruenwald
3x10 mm
bite down angle 45°

TWS 84-2034/28 5"
TWS 84-2034/29 7"



Spurling
4x10 mm
bite straight

TWS 84-2034/30 5"
TWS 84-2034/31 7"



Spurling
4x10 mm
bite up angle 45°

TWS 84-2034/32 5"
TWS 84-2034/33 7"



Spurling
4x10 mm
bite down angle 45°

TWS 84-2034/34 5"
TWS 84-2034/35 7"



TW Surgical

SPINAL IVD RONGEURS

CASPAR STYLE INTERVERTEBRAL DISC RONGEUR (HANDLE STYLE I)



Straight



Up angle 45°



Down angle 45°



6" straight

- TWS 84-2034/36 2X10mm
- TWS 84-2034/37 3X10 mm
- TWS 84-2034/38 4X10mm
- TWS 84-2034/39 5X10mm



6" up angle 45°

- TWS 84-2034/40 2X10mm
- TWS 84-2034/41 3X10 mm
- TWS 84-2034/42 4X10mm



6" down angle 45°

- TWS 84-2034/43 2X10mm
- TWS 84-2034/44 3X10 mm
- TWS 84-2034/45 4X10mm



6 1/4" straight

- Fenestrated jaw, serrated cup
- TWS 84-2034/46 2X12mm
- TWS 84-2034/47 3X12mm
- TWS 84-2034/48 4X14mm
- TWS 84-2034/49 5X14mm



7 1/4" up angle 45°

- Fenestrated jaw, serrated cup
- TWS 84-2034/50 3X12mm
- TWS 84-2034/51 4X14mm
- TWS 84-2034/52 5X14mm



7 1/4" down angle 45°

- Fenestrated jaw, serrated cup
- TWS 84-2034/53 3X12mm
- TWS 84-2034/54 4X14mm



7 1/4" Straight

- Fenestrated jaw, serrated cup
- TWS 84-2034/55 2X12mm
- TWS 84-2034/56 3X12mm
- TWS 84-2034/57 4X14mm
- TWS 84-2034/58 5X14mm
- TWS 84-2034/59 6X14mm



TW Surgical

SPINAL IVD RONGEURS

FERRIS-SMITH INTERVERTEBRAL DISC RONGEUR (HANDLE STYLE VI)

7" (178mm) shaft



Ring handle lessens chance of slippage.

Straight



Up angle 45°



Down angle 45°



7" straight

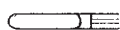

TWS 84-2034/60 2X10mm



TWS 84-2034/61 3X10 mm



TWS 84-2034/62 4X10mm



TWS 84-2034/63 6X12mm

7" bite up



TWS 84-2034/64 2X10mm



TWS 84-2034/65 3X10 mm



TWS 84-2034/66 4X10mm



TWS 84-2034/67 6X12mm

7" bite down

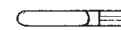

TWS 84-2034/68 2X10mm

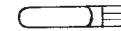

TWS 84-2034/69 3X10 mm



TWS 84-2034/70 4X10mm



TWS 84-2034/71 6X12mm



TW Surgical

SPINAL IVD RONGEURS

1/1 

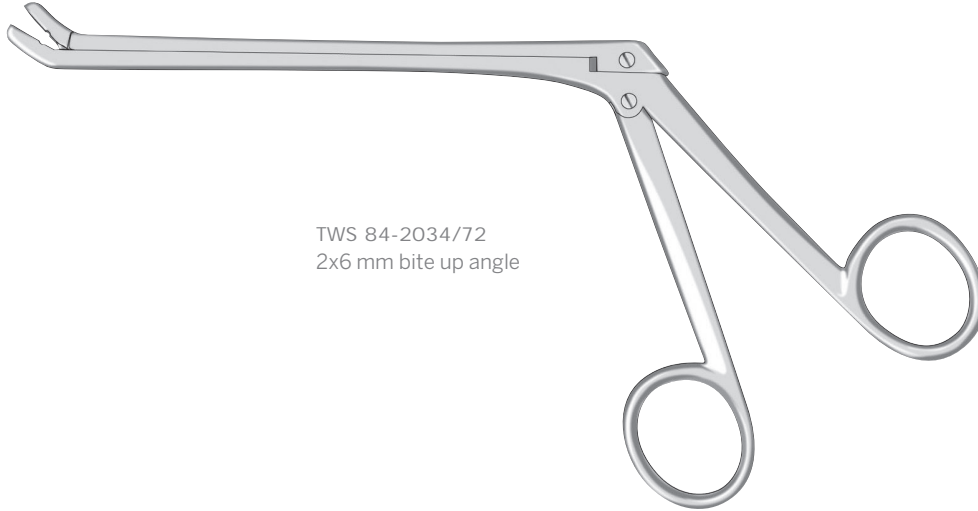

TWS 84-2034/72
2x6 mm bite up angle

PEAPOD INTERVERTEBRAL DISC RONGEUR (HANDLE STYLE I)

5 1/2" (140mm) shaft

1/1 



TWS 84-2034/73
3x10 mm bite straight

TAKAHASHI INTERVERTEBRAL DISC RONGEUR (HANDLE STYLE I)

5 1/2" (140mm) shaft

Treasure Wright (U.K.) Ltd.

128-160 City Road, London, EC1V 2NX, United Kingdom
info@twrightmedical.com



TW Surgical

SPINAL IVD RONGEURS

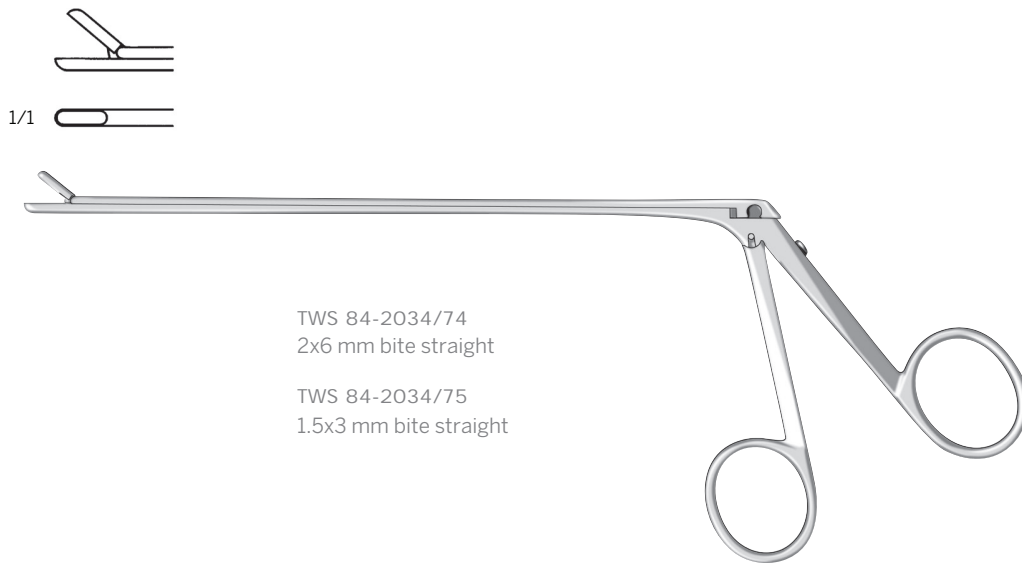

DECKER INTERVERTEBRAL DISC RONGEUR (HANDLE STYLE I)

6" (152mm) shaft



WILDE INTERVERTEBRAL DISC RONGEUR (HANDLE STYLE I)

Treasure Wright (U.K.) Ltd.

128-160 City Road, London, EC1V 2NX, United Kingdom
info@twrightmedical.com



TW Surgical

SPINAL IVD RONGEURS

1/1 



TWS 84-2034/79

6 mm bite round

OLDBERG INTERVERTEBRAL DISC RONGEUR (HANDLE STYLE I)

7" (178mm) shaft



TWS 84-2034/80

2mm with 1X2 teeth

WILLIAMS IVD RONGEUR

5 1/4" (135mm)

Treasure Wright (U.K.) Ltd.

128-160 City Road, London, EC1V 2NX, United Kingdom
info@twrightmedical.com



TW Surgical

SPINAL IVD RONGEURS

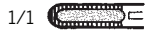
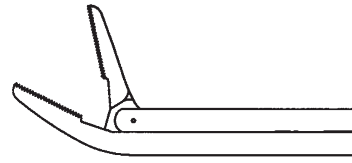
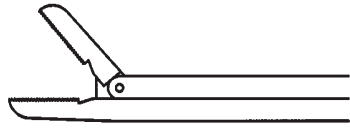

TWS 84-2034/81
2x10 mm bite
straight



TWS 84-2034/82
3x10 mm
bite straight



TWS 84-2034/83
4x10 mm
bite straight



TWS 84-2034/84
3x10 mm
bite up angle



SCHLESINGER INTERVERTEBRAL DISC RONGEUR (HANDLE STYLE I)

6" (152mm) shaft
serrated jaws

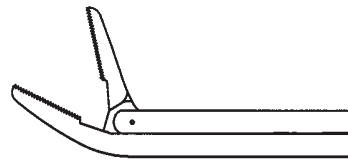
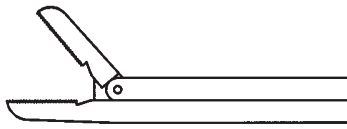

TWS 84-2034/85
3x10 mm bite
straight



TWS 84-2034/86
5x10 mm
bite straight



TWS 84-2034/87
3x10 mm
bite up angle



TWS 84-2034/88
5x10 mm
bite up angle



SCHLESINGER INTERVERTEBRAL DISC RONGEUR (HANDLE STYLE I)

9" (229mm) shaft
serrated jaws

Treasure Wright (U.K.) Ltd.

128-160 City Road, London, EC1V 2NX, United Kingdom
info@twrightmedical.com

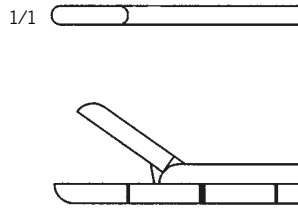

TWS 84-2034/89
2 1/2x10 mm
bite straight

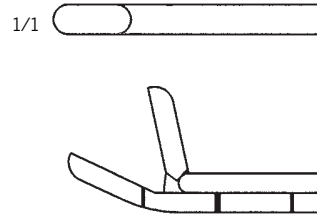

TWS 84-2034/90
4x10 mm
bite up angle

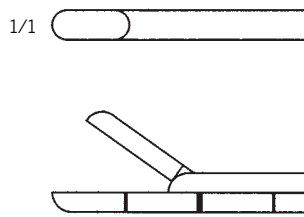

TWS 84-2034/91
4x10 mm
bite straight

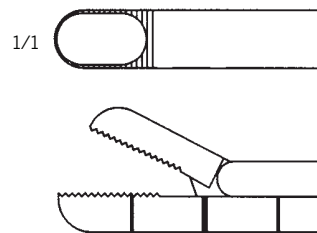

TWS 84-2034/92
8x12 mm
bite straight, serrated

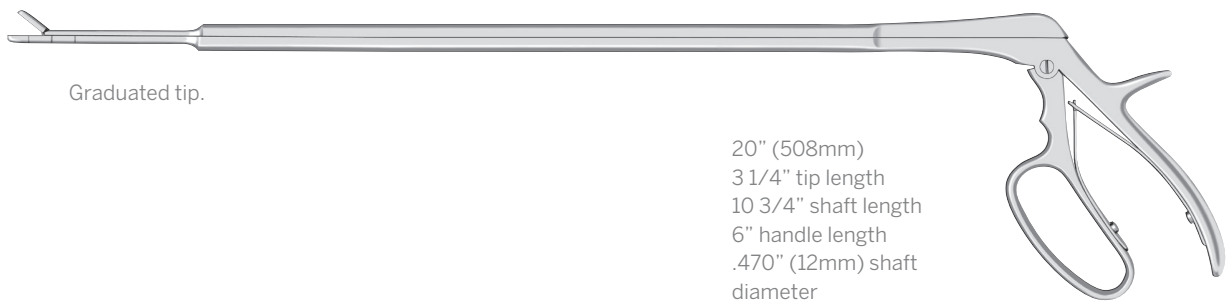

FERRIS-SMITH INTERVERTEBRAL DISC RONGEUR ENDOSCOPIC (HANDLE STYLE VI)

SPINAL PUNCHES



Note:

- Thin footplate designed specifically for small bone in the cervical area
- Gold hexagonal screw denotes thin footplate
- "Bite size" etched on handle for quick identification
- Care should be taken when using delicate thin footplate punches
- Do not twist or pry instrument while cutting
- Do not use on large bones

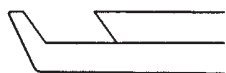

Forward 40° Thin Footplate



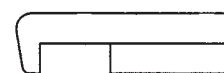

Up 90° Thin Footplate





Down 90° Thin Footplate

- 1/1  1mm bite forward
 TWS 84-2034/93 6" (152mm)
 TWS 84-2034/94 7" (178mm)
 TWS 84-2034/95 8" (203mm)

- 1/1  1mm bite up
 TWS 84-2035/09 7" (178mm)

- 1/1  1mm bite down
 TWS 84-2035/14 7" (178mm)

- 1/1  2mm bite forward
 TWS 84-2034/96 6" (152mm)
 TWS 84-2034/97 7" (178mm)
 TWS 84-2034/98 8" (203mm)

- 1/1  2mm bite up
 TWS 84-2035/10 7" (178mm)

- 1/1  2mm bite down
 TWS 84-2035/15 0 7" (178mm)

- 1/1  3mm bite forward
 TWS 84-2034/99 6" (152mm)
 TWS 84-2035/00 7" (178mm)
 TWS 84-2035/01 8" (203mm)

- 1/1  3mm bite up
 TWS 84-2035/11 7" (178mm)

- 1/1  3mm bite down
 TWS 84-2035/16 7" (178mm)

- 1/1  4mm bite forward
 TWS 84-2035/02 6" (152mm)
 TWS 84-2035/03 7" (178mm)
 TWS 84-2035/04 8" (203mm)

- 1/1  4mm bite up
 TWS 84-2035/12 7" (178mm)

- 1/1  4mm bite down
 TWS 84-2035/17 7" (178mm)

- 1/1  5mm bite forward
 TWS 84-2035/05 6" (152mm)
 TWS 84-2035/06 7" (178mm)
 TWS 84-2035/07 8" (203mm)

- 1/1  5mm bite up
 TWS 84-2035/13 7" (178mm)

- 1/1  5mm bite down
 TWS 84-2035/18 7" (178mm)

- 1/1  6mm bite forward
 TWS 84-2035/08 8" (203mm)

THIN FOOTPLATE KERRISON PUNCH (HANDLE STYLE V)



TW Surgical

SPINAL PUNCHES



Note:

- Thin footplate designed specifically for small bone in the cervical area
- Gold hexagonal screw denotes thin footplate
- "Bite size" etched on handle for quick identification
- Care should be taken when using delicate thin footplate punches
- Do not twist or pry instrument while cutting
- Do not use on large bones

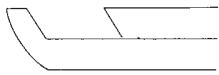

Forward 40° Regular Footplate

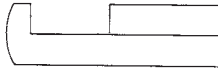

Up 90° Regular Footplate



Down 90° Regular Footplate

- 1/1 1mm bite forward
TWS 84-2035/19 7" (178mm)
TWS 84-2035/20 8" (203mm)

- 1/1 2mm bite forward
TWS 84-2035/21 7" (178mm)
TWS 84-2035/22 8" (203mm)
TWS 84-2035/23 11" (279mm)

- 1/1 3mm bite forward
TWS 84-2115/21 7" (178mm)
TWS 84-2115/22 8" (203mm)
TWS 84-2115/23 11" (279mm)

- 1/1 4mm bite forward
TWS 84-2115/24 7" (178mm)
TWS 84-2115/25 8" (203mm)
TWS 84-2115/26 11" (279mm)

- 1/1 5mm bite forward
TWS 84-2115/27 7" (178mm)
TWS 84-2115/28 8" (203mm)
TWS 84-2115/29 11" (279mm)

- 1/1 6mm bite forward
TWS 84-2115/30 7" (178mm)
TWS 84-2115/31 8" (203mm)
TWS 84-2115/32 11" (279mm)

- 1/1 2mm bite up
TWS 84-2035/24 7" (178mm)
TWS 84-2035/25 8" (203mm)

- 1/1 3mm bite up
TWS 84-2035/28 7" (178mm)
TWS 84-2035/29 8" (203mm)

- 1/1 4mm bite up
TWS 84-2035/30 7" (178mm)
TWS 84-2035/31 8" (203mm)

- 1/1 5mm bite up
TWS 84-2035/32 7" (178mm)
TWS 84-2035/33 8" (203mm)

- 1/1 6mm bite up
TWS 84-2035/34 7" (178mm)

- 1/1 2mm bite down
TWS 84-2035/26 7" (178mm)
TWS 84-2035/27 8" (203mm)

- 1/1 3mm bite down
TWS 84-2035/36 7" (178mm)
TWS 84-2035/37 8" (203mm)

- 1/1 4mm bite down
TWS 84-2035/38 7" (178mm)
TWS 84-2035/39 8" (203mm)

- 1/1 5mm bite down
TWS 84-2035/40 5 7" (178mm)
TWS 84-2035/41 8" (203mm)

- 1/1 6mm bite down
TWS 84-2035/35 7" (178mm)

SPURLING KERRISON PUNCH (HANDLE STYLE V)

Treasure Wright (U.K.) Ltd.

128-160 City Road, London, EC1V 2NX, United Kingdom
info@twrightmedical.com

SPINAL PUNCHES

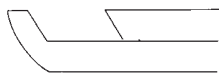

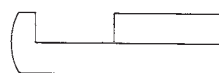

forward 40° Regular Footplate









Up 90° Regular Footplate



Down 90° Regular Footplate

- 1/1  2mm bite forward
TWS 84-2035/42 8" (203mm)
- 1/1  3mm bite forward
TWS 84-2035/43 6" (152mm)
TWS 84-2035/44 8" (203mm)
- 1/1  4mm bite forward
TWS 84-2035/45 8" (203mm)
- 1/1  5mm bite forward
TWS 84-2035/46 6" (152mm)
TWS 84-2035/47 8" (203mm)
- 1/1  6mm bite forward
TWS 84-2035/48 11" (279mm)

- 1/1  3mm bite up
TWS 84-2035/49 6" (152mm)
TWS 84-2035/50 8" (203mm)
- 1/1  4mm bite up
TWS 84-2035/51 6" (152mm)
TWS 84-2035/52 8" (203mm)
- 1/1  5mm bite up
TWS 84-2035/53 6" (152mm)
TWS 84-2035/54 8" (203mm)

- 1/1  3mm bite down
TWS 84-2035/55 6" (152mm)
TWS 84-2035/56 8" (203mm)
- 1/1  4mm bite down
TWS 84-2035/57 6" (152mm)
TWS 84-2035/58 8" (203mm)
- 1/1  5mm bite down
TWS 84-2035/59 6" (152mm)
TWS 84-2035/60 8" (203mm)

LOVE-KERRISON LAMINECTOMY PUNCH (HANDLE STYLE IV) LARGE HANDLE





TW Surgical

SPINAL IVD RONGEURS



up bite regular footplate

1/1  3mm bite up
TWS 84-2035/61

1/1  5mm bite up
TWS 84-2035/62

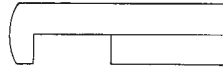

down bite regular footplate

1/1  3mm bite down
TWS 84-2035/63

1/1  5mm bite down
TWS 84-2035/64



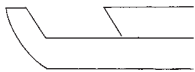

SCHLESINGER CERVICAL LAMINECTOMY PUNCH (HANDLE STYLE IV) LARGE HANDLE

6" (152mm) shaft
regular footplate



forward 40° regular footplate

1/1  3mm bite
TWS 84-2035/65 7"
TWS 84-2035/66 "

1/1  5mm bite
TWS 84-2035/67 7"
TWS 84-2035/68 8"

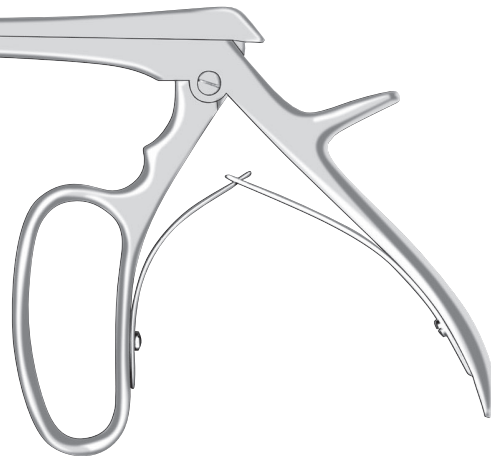



FERRIS SMITH KERRISON PUNCH (HANDLE STYLE V)

Regular footplate

Treasure Wright (U.K.) Ltd.

128-160 City Road, London, EC1V 2NX, United Kingdom
info@twrightmedical.com

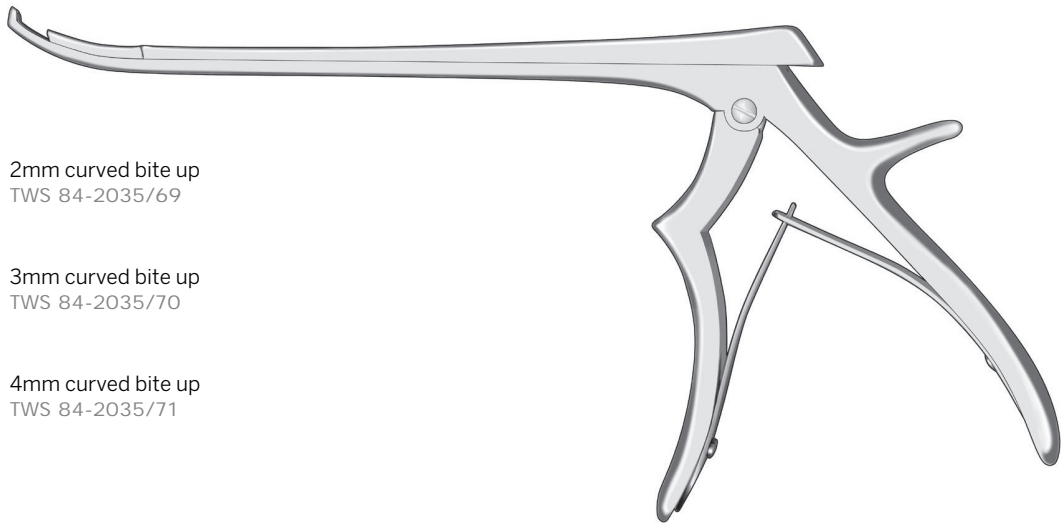

SPINAL PUNCHES

- 1/1  2mm curved bite up
TWS 84-2035/69
- 1/1  3mm curved bite up
TWS 84-2035/70
- 1/1  4mm curved bite up
TWS 84-2035/71





FORAMENOTOMY PUNCH (HANDLE STYLE V)

8" (203mm) shaft
regular footplate

- 1/1  Fenestrated upper shaft ejects cut pieces of bone and tissue.
- 1/1 

Fenestrated upper shaft ejects cut pieces of bone and tissue.

- 1/1  2mm bite forward
TWS 84-2035/72
- 1/1  3mm bite forward
TWS 84-2035/73



MULTI-BITE KERRISON PUNCH (HANDLE STYLE VIII)

7" (178mm) shaft
delicate thin footplate. For cervical use only.



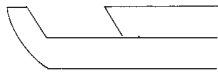

TW Surgical

SPINAL PUNCHES





forward 40° regular footplate

1/1  2mm bite
TWS 84-2035/74

1/1  3mm bite
TWS 84-2035/75

1/1  4mm bite
TWS 84-2035/76

1/1  5mm bite
TWS 84-2035/77

1/1  6mm bite
TWS 84-2035/78



Compact handle designed to accommodate smaller hands.

SPURLING KERRISON PUNCH (HANDLE STYLE V)

11" (280mm) shaft
regular footplate

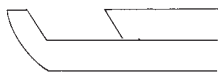

forward 40° regular footplate

1/1 



TWS 84-2035/79
11" (280mm) shaft
6mm bite forward
regular footplate

LOVE-KERRISON LAMINECTOMY PUNCH (HANDLE STYLE IV) LARGE HANDLE

Regular footplate

Treasure Wright (U.K.) Ltd.

128-160 City Road, London, EC1V 2NX, United Kingdom
info@twrightmedical.com

SPINAL PUNCHES



TWS 84-2035/80
2.5mm bite forward
forward 40°



TWS 84-2035/81
4mm bite forward
forward 40°

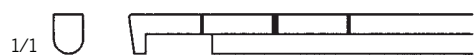

TWS 84-2035/82
4mm bite down down
90°

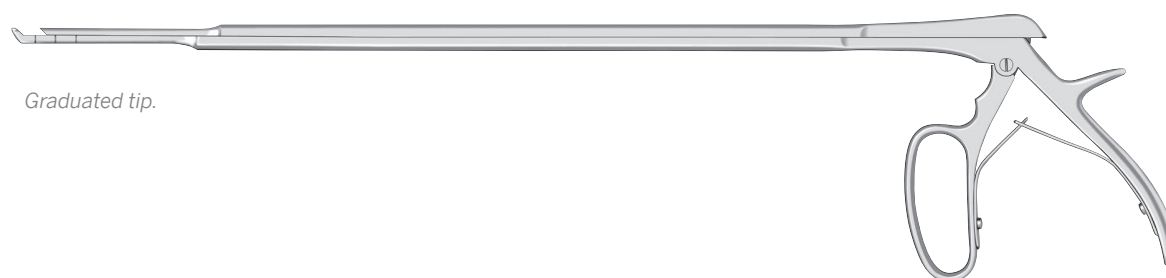

Graduated tip.

20" (508mm)
3 1/4" tip length
10 3/4" shaft length
6" handle length
.470" (12mm) shaft diameter
regular footplate

FERRIS-SMITH KERRISON PUNCH ENDOSCOPIC



TW Surgical

SPINAL PUNCHES

15mm Jaw opening

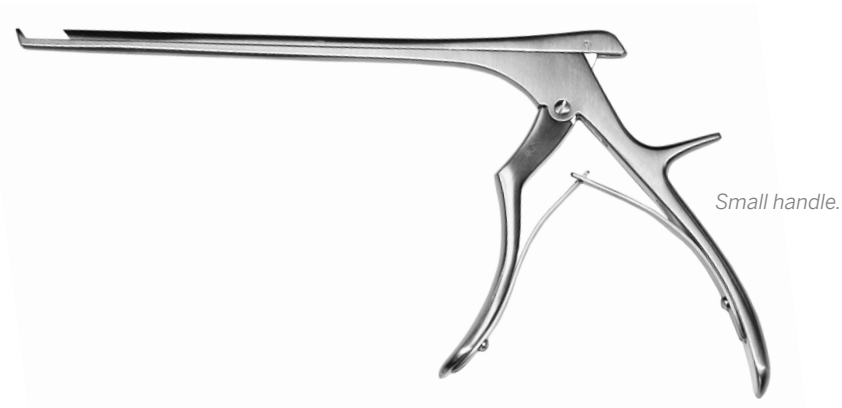

40 degree forward with 15mm opening small handle

- TWS 84-2035/83 1mm
- TWS 84-2035/84 2mm
- TWS 84-2035/85 3mm
- TWS 84-2035/86 4mm
- TWS 84-2035/87 5mm
- TWS 84-2035/88 6mm

thin foot plate

- TWS 84-2035/89 1mm
- TWS 84-2035/90 2mm
- TWS 84-2035/91 3mm
- TWS 84-2035/92 4mm
- TWS 84-2035/93 5mm
- TWS 84-2035/94 6mm

FERRIS SMITH KERRISON RONGEUR

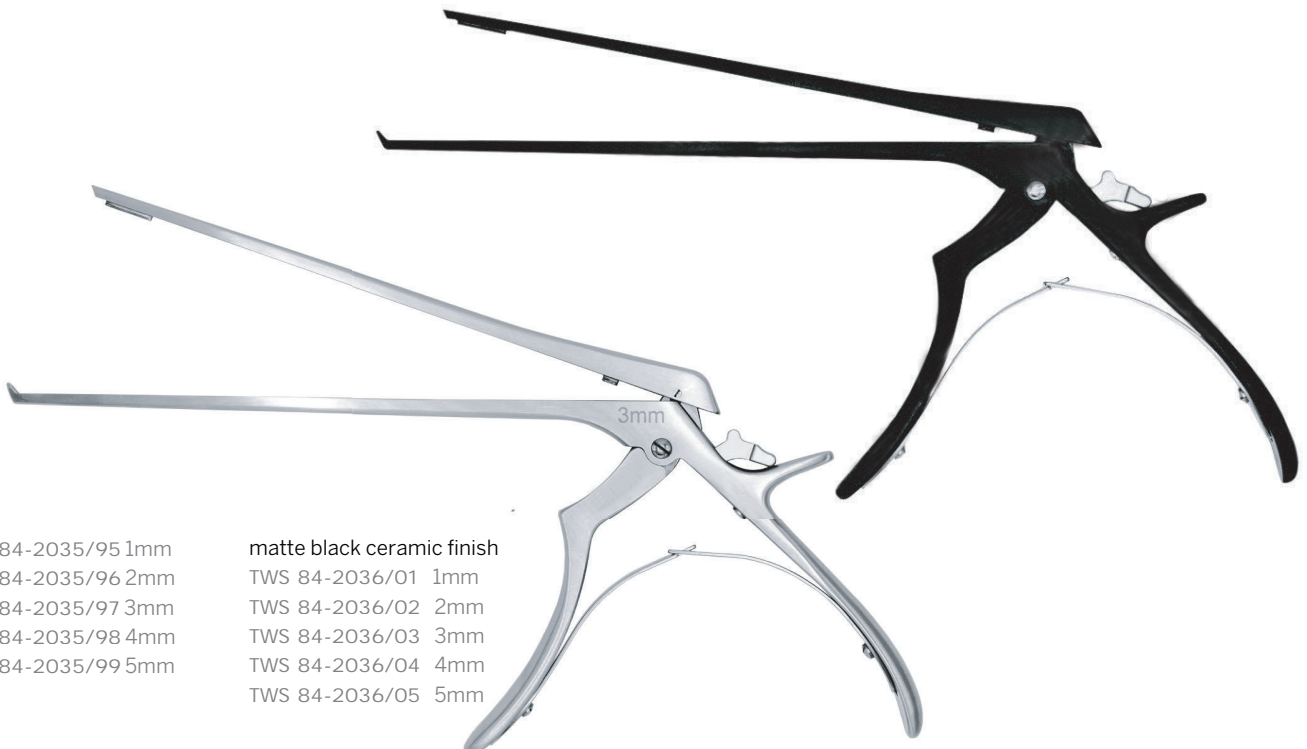

- TWS 84-2035/95 1mm
- TWS 84-2035/96 2mm
- TWS 84-2035/97 3mm
- TWS 84-2035/98 4mm
- TWS 84-2035/99 5mm

matte black ceramic finish

- TWS 84-2036/01 1mm
- TWS 84-2036/02 2mm
- TWS 84-2036/03 3mm
- TWS 84-2036/04 4mm
- TWS 84-2036/05 5mm

SWING APART KERRISON RONGEUR TFP

8" 40 degree forward

Treasure Wright (U.K.) Ltd.

128-160 City Road, London, EC1V 2NX, United Kingdom
info@twrightmedical.com



TW Surgical

CATCH THE NEW WAVE IN EASY CLEANING.

In most spinal punches, tissue and debris can collect and remain trapped between the main body and slider. This build-up can impede the smooth function of the instrument and prevent proper sterilization as a result of not being completely cleaned prior to sterilization.

The Clean Wave Kerrison Punch has a slider with a wavelike shaped design which allows cleaning brushes easy access through the recesses and openings between the slider and main body for cleaning prior to sterilization.



CLEAN WAVE KERRISON RONGEUR

8" (203mm)

Ferris-Smith-Kerrison handle, thin foot plate

TWS 84-2036/06 1mm without ejector

TWS 84-2036/07 2mm without ejector

TWS 84-2036/09 3mm without ejector

TWS 84-2036/08 4mm without ejector

TWS 84-2036/10 5mm without ejector

7" (178mm)

Ferris-Smith-Kerrison handle, thin foot plate

TWS 84-2036/11 1mm without ejector

TWS 84-2036/12 2mm without ejector

TWS 84-2036/13 3mm without ejector

TWS 84-2036/14 4mm without ejector

TWS 84-2036/15 5mm without ejector

Treasure Wright (U.K.) Ltd.

128-160 City Road, London, EC1V 2NX, United Kingdom
info@twrightmedical.com



TW
Surgical

Treasure Wright (U.K.) Ltd.

**Address: 128-160 , City Road,
London EC1V 2NX. United Kingdom**

www.twrightmedical.com

info@twrightmedical.com



TW Surgical



**UK
CA CE**