



TW
Surgical

MICRO KERRISONS RONGEUR



**UK
CA** **CE**



TW Surgical

Treasure Wright (U.K.) Ltd.



www.twrightmedical.com



info@twrightmedical.com

MICRO KERRISONS RONGEUR

- SMALL HANDLE

40 Degree Up — 9 mm Opening — Standard Footplate

TWS Kerrison Rongeurs are made using the highest quality materials available, and are manufactured by professional craftsmen, who have honed their skill over decades.

Micro Kerrison Rongeur-Small Handle 40° Up 9mm Opening Standard Footplate Material: Stainless Steel						
Size	1mm	2mm	3mm	4mm	5mm	6mm
175mm	TWS 83-1000/01	TWS 83-1000/06	TWS 83-1000/11	TWS 83-1000/16	TWS 83-1000/21	TWS 83-1000/26
200mm	TWS 83-1000/02	TWS 83-1000/07	TWS 83-1000/12	TWS 83-1000/17	TWS 83-1000/22	TWS 83-1000/27
225mm	TWS 83-1000/03	TWS 83-1000/08	TWS 83-1000/13	TWS 83-1000/18	TWS 83-1000/23	TWS 83-1000/28
250mm	TWS 83-1000/04	TWS 83-1000/09	TWS 83-1000/14	TWS 83-1000/19	TWS 83-1000/24	TWS 83-1000/29
275mm	TWS 83-1000/05	TWS 83-1000/10	TWS 83-1000/15	TWS 83-1000/20	TWS 83-1000/25	TWS 83-1000/30

Micro Kerrison Rongeur-Small Handle 40° Up 9mm Opening Standard Footplate Material: Stainless Steel						
Size	1mm	2mm	3mm	4mm	5mm	6mm
175mm	TWS 83-1000/31	TWS 83-1000/36	TWS 83-1000/41	TWS 83-1000/46	TWS 83-1000/51	TWS 83-1000/56
200mm	TWS 83-1000/32	TWS 83-1000/37	TWS 83-1000/42	TWS 83-1000/47	TWS 83-1000/52	TWS 83-1000/57
225mm	TWS 83-1000/33	TWS 83-1000/38	TWS 83-1000/43	TWS 83-1000/48	TWS 83-1000/53	TWS 83-1000/58
250mm	TWS 83-1000/34	TWS 83-1000/39	TWS 83-1000/44	TWS 83-1000/49	TWS 83-1000/54	TWS 83-1000/59
275mm	TWS 83-1000/35	TWS 83-1000/40	TWS 83-1000/45	TWS 83-1000/50	TWS 83-1000/55	TWS 83-1000/60



MICRO KERRISONS RONGEUR

- LARGE HANDLE

40 Degree Up — 9 mm Opening — Standard Footplate

TWS Kerrison Rongeurs are made using the highest quality materials available, and are manufactured by professional craftsmen, who have honed their skill over decades.

Micro Kerrison Rongeur - Large Handle 40° Up 9mm Opening Standard Footplate Stainless Steel						
Size	1mm	2mm	3mm	4mm	5mm	6mm
175mm	TWS 83-1000/61	TWS 83-1000/66	TWS 83-1000/71	TWS 83-1000/76	TWS 83-1000/81	TWS 83-1000/86
200mm	TWS 83-1000/62	TWS 83-1000/67	TWS 83-1000/72	TWS 83-1000/77	TWS 83-1000/82	TWS 83-1000/87
225mm	TWS 83-1000/63	TWS 83-1000/68	TWS 83-1000/73	TWS 83-1000/78	TWS 83-1000/83	TWS 83-1000/88
250mm	TWS 83-1000/64	TWS 83-1000/69	TWS 83-1000/74	TWS 83-1000/79	TWS 83-1000/84	TWS 83-1000/89
275mm	TWS 83-1000/65	TWS 83-1000/70	TWS 83-1000/75	TWS 83-1000/80	TWS 83-1000/85	TWS 83-1000/90

Micro Kerrison Rongeur - Large Handle 40° Up 9mm Opening Standard Footplate with Ejector Material : Stainless Steel						
Size	1mm	2mm	3mm	4mm	5mm	6mm
175mm	TWS 83-1000/91	TWS 83-1000/96	TWS 83-1001/01	TWS 83-1001/06	TWS 83-1001/11	TWS 83-1001/16
200mm	TWS 83-1000/92	TWS 83-1000/97	TWS 83-1001/02	TWS 83-1001/07	TWS 83-1001/12	TWS 83-1001/17
225mm	TWS 83-1000/93	TWS 83-1000/98	TWS 83-1001/03	TWS 83-1001/08	TWS 83-1001/13	TWS 83-1001/18
250mm	TWS 83-1000/94	TWS 83-1000/99	TWS 83-1001/04	TWS 83-1001/09	TWS 83-1001/14	TWS 83-1001/19
275mm	TWS 83-1000/95	TWS 83-1001/00	TWS 83-1001/05	TWS 83-1001/10	TWS 83-1001/15	TWS 83-1001/20



MICRO KERRISONS - SMALL HANDLE

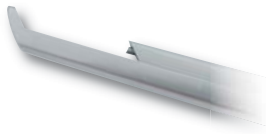

40 Degrees Up — 15 mm Opening — Thin Footplate

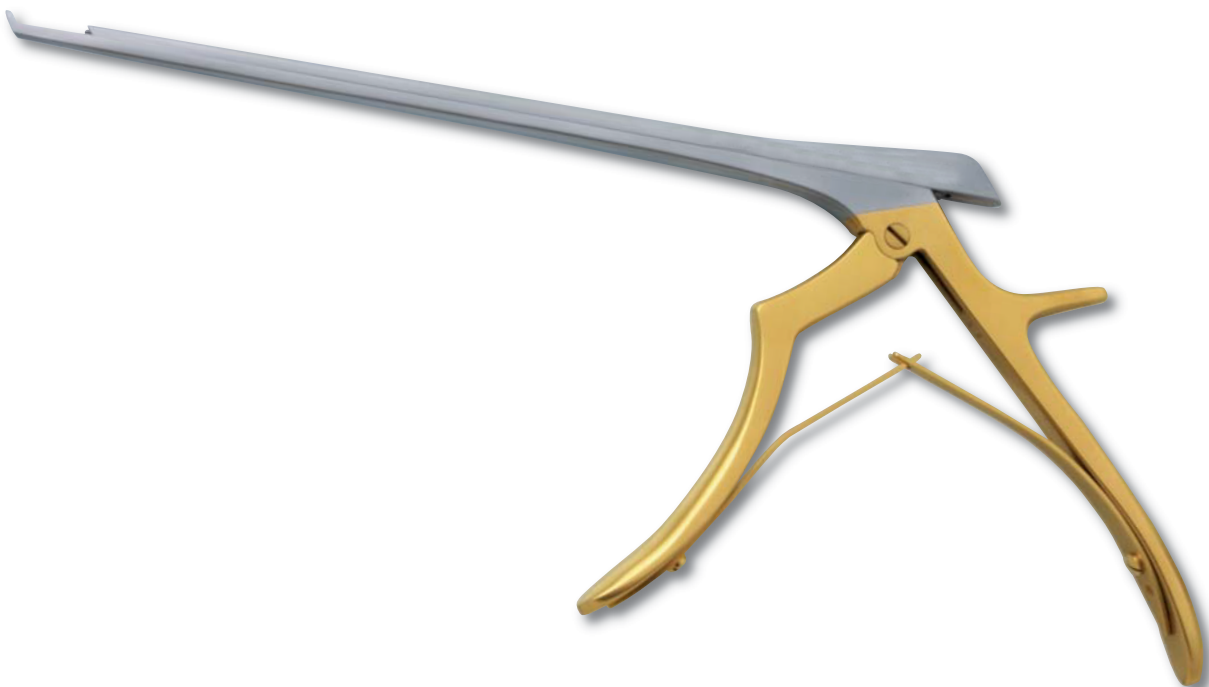
FAMILY	BITE SIZE	1:1	LENGTH 8" / 200 mm	PRODUCT IMAGES
40 Degrees Up with Ejector (except for 1 mm, which has no ejector)	1 mm	∩	TWS 83-1001/21	
	2 mm	∩	TWS 83-1001/22	
	3 mm	∩	TWS 83-1001/23	
	4 mm	∩	TWS 83-1001/24	



MICRO KERRISONS - SMALL HANDLE

40 and 90 Degrees Down — 9 mm Bite Opening — Standard Footplate

FAMILY	BITE SIZE	1:1	LENGTH 8" / 200 mm	PRODUCT IMAGES
40 Degree Down with Ejector	2 mm	U	TWS 83-1001/25	
	3 mm	U	TWS 83-1001/26	
	4 mm	U	TWS 83-1001/27	
	5 mm	U	TWS 83-1001/28	
90 Degree Down with Ejector	2 mm	U	TWS 83-1001/29	
	3 mm	U	TWS 83-1001/30	
	4 mm	U	TWS 83-1001/31	
	5 mm	U	TWS 83-1001/32	





SPURLING KERRISONS - LARGE HANDLE

40 and 90 Degrees Up — 16 mm Opening — Thin and Standard Footplate

TWS Spurling Kerrisons transfer enormous power from the large handle through the 16 mm opening.

1:3 (9"/230 mm)



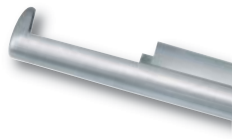





















FAMILY	BITE SIZE	1:1	LENGTH 7"/180 mm	LENGTH 8"/200 mm	LENGTH 9"/230 mm	LENGTH 10"/255 mm	LENGTH 12"/300 mm	PRODUCT IMAGES
40 Degrees Up Thin Footplate with Ejector	2 mm	∩		TWS 83-1001/33		TWS 83-1001/34	TWS 83-1001/3	
	3 mm	∩		TWS 83-1001/36		TWS 83-1001/37	TWS 83-1001/3	
	4 mm	∩		TWS 83-1001/39		TWS 83-1001/40	TWS 83-1001/4	
	5 mm	∩		TWS 83-1001/42		TWS 83-1001/43	TWS 83-1001/4	
40 Degrees Up Standard Footplate with Ejector	2 mm	∩	TWS 83-1001/45	TWS 83-1001/46	TWS 83-1001/47	TWS 83-1001/48	TWS 83-1001/49	
	3 mm	∩	TWS 83-1001/50	TWS 83-1001/51	TWS 83-1001/52	TWS 83-1001/53	TWS 83-1001/54	
	4 mm	∩	TWS 83-1001/55	TWS 83-1001/56	TWS 83-1001/57	TWS 83-1001/58	TWS 83-1001/59	
	5 mm	∩	TWS 83-1001/60	TWS 83-1001/61	TWS 83-1001/62	TWS 83-1001/63	TWS 83-1001/64	
	6 mm	∩	TWS 83-1001/65	TWS 83-1001/66	TWS 83-1001/67			
90 Degrees Up Standard Footplate with Ejector	2 mm	∩	TWS 83-1001/68	TWS 83-1001/69	TWS 83-1001/70	TWS 83-1001/71	TWS 83-1001/72	
	3 mm	∩	TWS 83-1001/77	TWS 83-1001/76	TWS 83-1001/75	TWS 83-1001/74	TWS 83-1001/73	
	4 mm	∩	TWS 83-1001/78	TWS 83-1001/79	TWS 83-1001/80	TWS 83-1001/81	TWS 83-1001/82	
	5 mm	∩	TWS 83-1001/83	TWS 83-1001/84	TWS 83-1001/85	TWS 83-1001/86	TWS 83-1001/87	
	6 mm	∩	TWS 83-1001/88	TWS 83-1001/89	TWS 83-1001/90			



SIMPLECLEAN™ KERRISON RONGEURS - SMALL HANDLE

Stainless Steel 40 Degree Up — 10 mm Opening — Thin and Standard Footplate

TWS SimpleClean™ Kerrison Rongeurs address a major issue in today's infection-conscious hospital: The shaft components separate from one another (but remain attached at the heel) to allow for simple cleaning of trapped tissues! Problem solved.

FAMILY	BITE SIZE	1:1	RELEASE COLOR	LENGTH 7" /180 mm	LENGTH 8" /200 mm	LENGTH 9" /230 mm	PRODUCT IMAGES
Micro (Small) Handle Thin Footplate with Ejector (except for 1 mm which has no Ejector)	1 mm			TWS 83-1001/91	TWS 83-1001/92	TWS 83-1001/93	
	2 mm			TWS 83-1001/94	TWS 83-1001/95	TWS 83-1001/96	
	3 mm			TWS 83-1001/97	TWS 83-1001/98	TWS 83-1001/99	
	4 mm			TWS 83-1002/00	TWS 83-1002/01	TWS 83-1002/02	
	5 mm			TWS 83-1002/03	TWS 83-1002/04	TWS 83-1002/05	
Micro (Small) Handle Standard Footplate with Ejector (except for 1 mm which has no Ejector)	1 mm			TWS 83-1002/06	TWS 83-1002/07	TWS 83-1002/08	
	2 mm			TWS 83-1002/09	TWS 83-1002/10	TWS 83-1002/11	
	3 mm			TWS 83-1002/12	TWS 83-1002/13	TWS 83-1002/14	
	4 mm			TWS 83-1002/15	TWS 83-1002/16	TWS 83-1002/17	
	5 mm			TWS 83-1002/18	TWS 83-1002/19	TWS 83-1002/20	
	6 mm			TWS 83-1002/21	TWS 83-1002/22	TWS 83-1002/23	

Opening a SimpleClean™ Kerrison is a matter of Simplicity:



1. Squeeze



2. Rotate the Release Knob

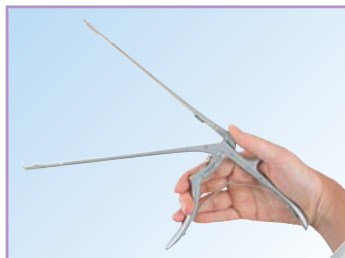

3. Open the Jaws!

1:3 (9"/230 mm)



KERRISON RONGEURS - SMALL HANDLE

Black Coated* 40 Degree Up — 10 mm Opening — Thin and Standard Footplate

The coating prevents irritating light reflections, increases surface hardness, ensures optimum gliding and reduces sticking.

Micro Kerrison Rongeur - Small Handle 40° Up 9mm Opening Black Coated Surface Standard Footplate Material : Stainless Steel						
Size	1mm	2mm	3mm	4mm	5mm	6mm
175mm	TWS 83-1002/31	TWS 83-1002/36	TWS 83-1002/41	TWS 83-1002/46	TWS 83-1002/51	TWS 83-1002/56
200mm	TWS 83-1002/32	TWS 83-1002/37	TWS 83-1002/42	TWS 83-1002/47	TWS 83-1002/52	TWS 83-1002/57
225mm	TWS 83-1002/33	TWS 83-1002/38	TWS 83-1002/43	TWS 83-1002/48	TWS 83-1002/53	TWS 83-1002/58
250mm	TWS 83-1002/34	TWS 83-1002/39	TWS 83-1002/44	TWS 83-1002/49	TWS 83-1002/54	TWS 83-1002/59
275mm	TWS 83-1002/35	TWS 83-1002/40	TWS 83-1002/45	TWS 83-1002/50	TWS 83-1002/55	TWS 83-1002/60

Micro Kerrison Rongeur - Large Handle 40° Up 9mm Opening Black Coated Surface Standard Footplate with Ejector Material : Stainless Steel						
Size	1mm	2mm	3mm	4mm	5mm	6mm
175mm	TWS 83-1002/61	TWS 83-1002/66	TWS 83-1002/71	TWS 83-1002/76	TWS 83-1002/81	TWS 83-1002/86
200mm	TWS 83-1002/62	TWS 83-1002/67	TWS 83-1002/72	TWS 83-1002/77	TWS 83-1002/82	TWS 83-1002/87
225mm	TWS 83-1002/63	TWS 83-1002/68	TWS 83-1002/73	TWS 83-1002/78	TWS 83-1002/83	TWS 83-1002/88
250mm	TWS 83-1002/64	TWS 83-1002/69	TWS 83-1002/74	TWS 83-1002/79	TWS 83-1002/84	TWS 83-1002/89
275mm	TWS 83-1002/65	TWS 83-1002/70	TWS 83-1002/75	TWS 83-1002/80	TWS 83-1002/85	TWS 83-1002/90



Kerrisons have a color-coded on the release, which makes bite size selection a matter of simplicity...

CUSTOMIZED STERILIZATION CONTAINER FOR SIMPLECLEAN™ KERRISON RONGEURS



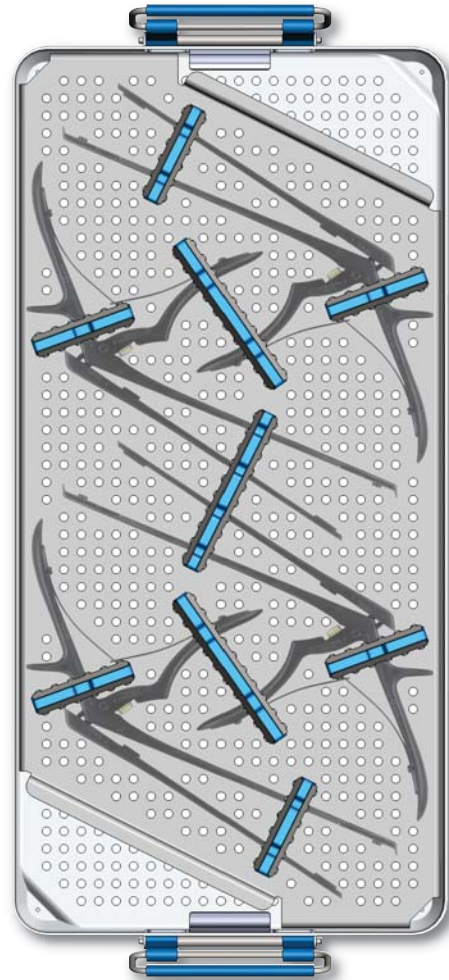
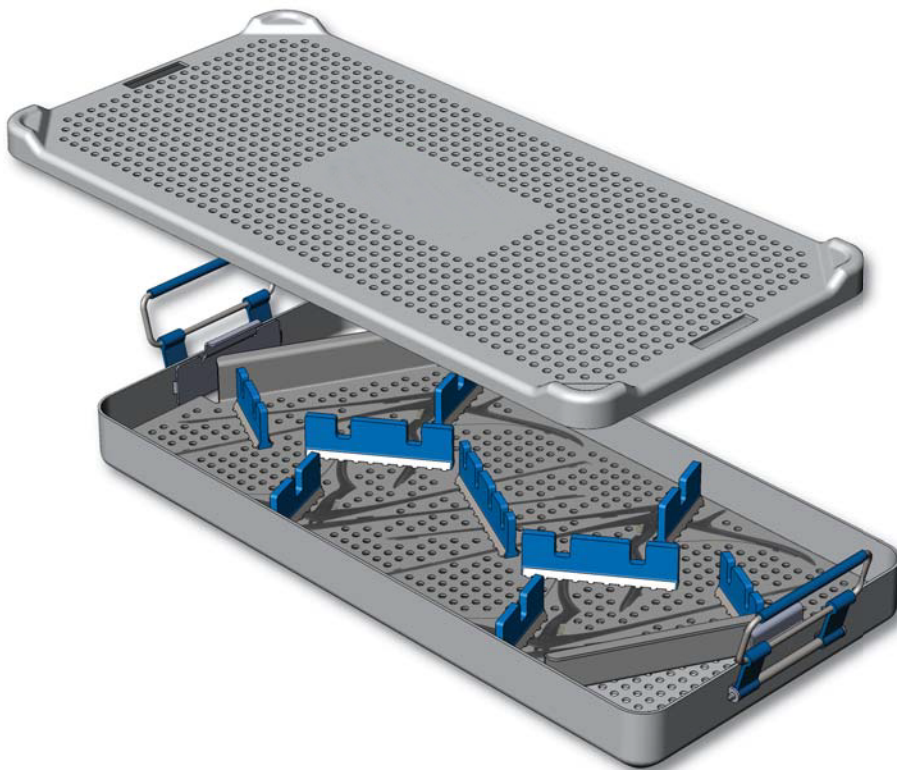



This customized tray will hold up to four TWS SimpleClean™ Kerrison Rongeurs, housed in an open position, allowing for more effective cleaning and sterilization of the internal instrument surfaces. Graphical representations of the Kerrisons are imaged on the bottom of the container for simple placement within the Sterile Processing Department. The inner container is easily removed from the outer tray so that it can be placed upon the Mayo Stand if desired.



MICRO SMALL-HANDLE BAYONET KERRISON THE “DARTH VADER” KERRISON

TiAIN Coated* 40 Degree Up — 9 mm Bite Opening — 9”/230 mm in Length — Thin Footplate

TWS Kerrison designed for use with MIS retraction portals or smaller incisions. Bayonet shape increases visibility to the operative site. Caution: Thin footplate construction designed for delicate use.

FAMILY	BITE SIZE	1:1	LENGTH 9”/230 mm	PRODUCT IMAGES
40 Degrees Up with Ejector (except for 1.5 mm which has no ejector)	1.5 mm		TWS 83-1002/91	
	2 mm		TWS 83-1002/92	
	3 mm		TWS 83-1002/93	
	4 mm		TWS 83-1002/94	
	5 mm		TWS 83-1002/95	

*The TiAIN coating prevents light reflections, increases surface hardness, and ensures smooth gliding of the shaft components.







1:2 (9”/230 mm)

FORAMINOTOMY KERRISONS - SMALL HANDLE

9 mm Opening

8" /200 mm LENGTH

FAMILY	BITE SIZE	1:1	70 DEGREE TIP	90 DEGREE TIP	PRODUCT IMAGES
Foraminotomy Kerrisons are offered with a curved shank, to allow direct access when performing a foraminotomy	2 mm		TWS 83-1002/96	TWS 83-1003/00	
	3 mm		TWS 83-1002/97	TWS 83-1003/01	
	4 mm		TWS 83-1002/98	TWS 83-1003/02	
	5 mm		TWS 83-1002/99	TWS 83-1003/03	

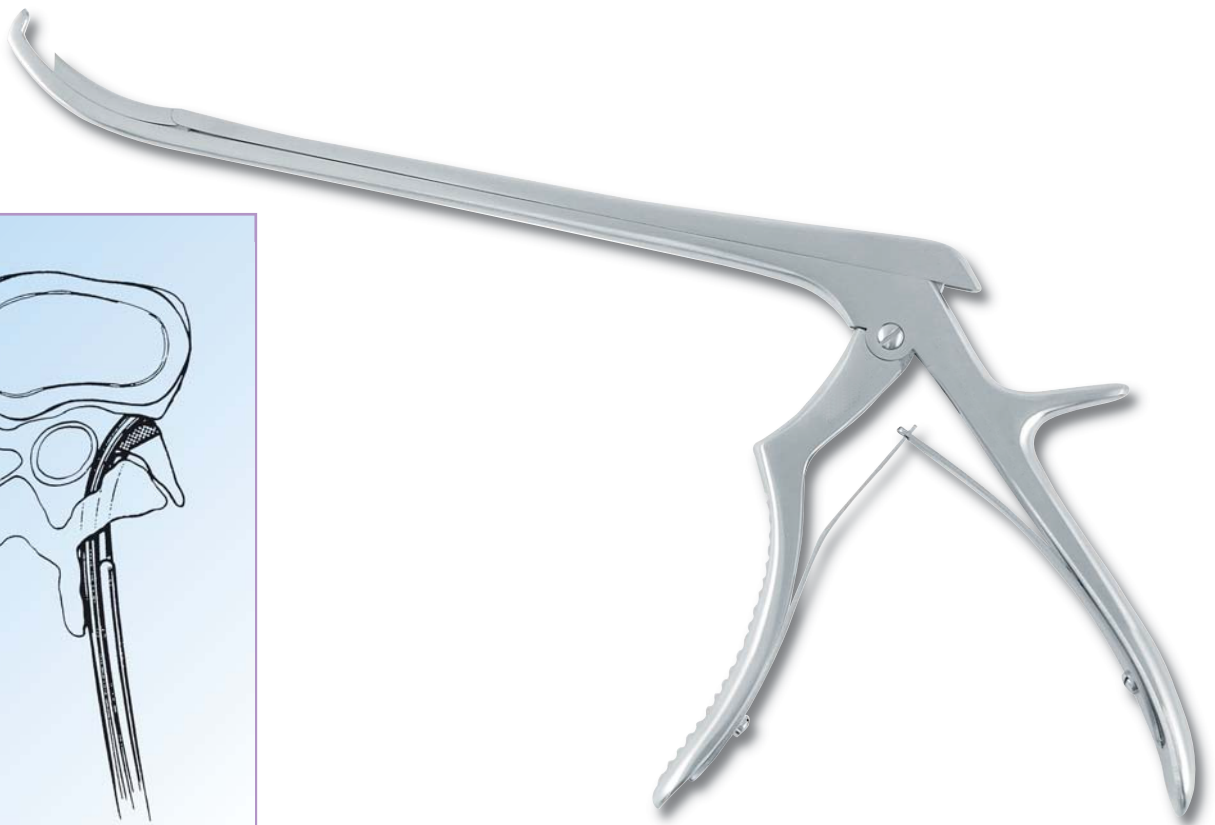
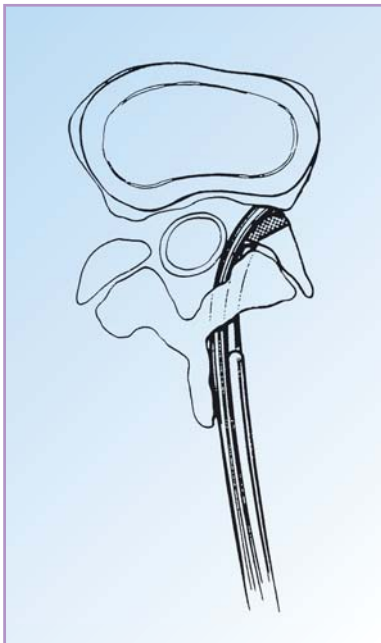





















2:3 (8" /200 mm)

IVD AND PITUITARY RONGEURS

Product numbers below are for stainless steel finish.

TiAIN coating will be available as a special order.























FAMILY	JAW WIDTH	1:1	LENGTH 7"/180 mm	LENGTH 8"/200 mm	LENGTH 10"/255 mm	LENGTH 12"/300 mm	PRODUCT IMAGES
Straight Jaws	1.5 mm		TWS 83-1003/04	TWS 83-1003/05			
	2 mm		TWS 83-1003/06	TWS 83-1003/07			
	3 mm		TWS 83-1003/08	TWS 83-1003/09	TWS 83-1003/10	TWS 83-1003/11	
	4 mm		TWS 83-1003/12	TWS 83-1003/13	TWS 83-1003/14	TWS 83-1003/15	
	5 mm		TWS 83-1003/16	TWS 83-1003/17	TWS 83-1003/18	TWS 83-1003/19	
	6 mm		TWS 83-1003/20	TWS 83-1003/21			
Jaws Angled Up	1.5 mm		TWS 83-1003/22	TWS 83-1003/23			
	2 mm		TWS 83-1003/24	TWS 83-1003/25			
	3 mm		TWS 83-1003/26	TWS 83-1003/27	TWS 83-1003/28	TWS 83-1003/29	
	4 mm		TWS 83-1003/30	TWS 83-1003/31	TWS 83-1003/32	TWS 83-1003/33	
	5 mm		TWS 83-1003/34	TWS 83-1003/35	TWS 83-1003/36	TWS 83-1003/37	
	6 mm		TWS 83-1003/38	TWS 83-1003/39			
Jaws Angled Down	1.5 mm		TWS 83-1003/40	TWS 83-1003/41			
	2 mm		TWS 83-1003/42	TWS 83-1003/43	TWS 83-1003/44	TWS 83-1003/45	
	3 mm		TWS 83-1003/46	TWS 83-1003/47	TWS 83-1003/48	TWS 83-1003/49	
	4 mm		TWS 83-1003/50	TWS 83-1003/51	TWS 83-1003/52	TWS 83-1003/53	
	5 mm		TWS 83-1003/54	TWS 83-1003/55			

WEIL-BLAKESLEY IVD RONGEURS

Available with straight jaws, jaws angled up, angled down, and in jaw sizes of 2.5 mm to 5 mm in .5 mm increments.



FAMILY	JAW WIDTH	1:1	LENGTH 7" / 180 mm	PRODUCT IMAGES
Straight Jaws	2.5 mm		TWS 83-1003/56	
	3 mm		TWS 83-1003/57	
	3.5 mm		TWS 83-1003/57	
	4 mm		TWS 83-1003/59	
	4.5 mm		TWS 83-1003/60	
	5 mm		TWS 83-1003/61	
Jaws Angled Up	2.5 mm		TWS 83-1003/62	
	3 mm		TWS 83-1003/63	
	3.5 mm		TWS 83-1003/64	
	4 mm		TWS 83-1003/65	
	4.5 mm		TWS 83-1003/66	
	5 mm		TWS 83-1003/67	
Jaws Angled Down	2.5 mm		TWS 83-1003/68	
	3 mm		TWS 83-1003/69	
	3.5 mm		TWS 83-1003/70	
	4 mm		TWS 83-1003/71	
	4.5 mm		TWS 83-1003/72	
	5 mm		TWS 83-1003/73	

SIMPLECLEAN™ IVD RONGUERS

Stainless Steel



FAMILY	JAW WIDTH	1:1	RELEASE COLOR	LENGTH 7"/180 mm	LENGTH 8"/200 mm	PRODUCT IMAGES
Standard SimpleClean™ IVD Straight Jaws	1.5 mm			TWS 83-1003/74	TWS 83-1003/86	
	2 mm			TWS 83-1003/75	TWS 83-1003/87	
	3 mm			TWS 83-1003/76	TWS 83-1003/88	
	4 mm			TWS 83-1003/77	TWS 83-1003/89	
Weil-Blakesley SimpleClean™ IVD Straight Jaws	2.5 mm			TWS 83-1003/78	TWS 83-1003/90	
	3.5 mm			TWS 83-1003/79	TWS 83-1003/91	
Standard SimpleClean™ IVD Jaws Angled Upwards 30 Degrees	1.5 mm			TWS 83-1003/80	TWS 83-1003/92	
	2 mm			TWS 83-1003/81	TWS 83-1003/93	
	3 mm			TWS 83-1003/82	TWS 83-1003/94	
	4 mm			TWS 83-1003/83	TWS 83-1003/95	
Weil-Blakesley SimpleClean™ IVD Jaws Angled Upwards 45 Degrees	2.5 mm			TWS 83-1003/84	TWS 83-1003/96	
	3.5 mm			TWS 83-1003/85	TWS 83-1003/97	

Opening a SimpleClean™ Rongeur:



1. Depress Release



2. Align Components



3. Separate Components

SIMPLECLEAN™ IVD RONGUERS

TiAIN Coated*







FAMILY	JAW WIDTH	1:1	RELEASE COLOR	LENGTH 7"/180 mm	LENGTH 8"/200 mm	PRODUCT IMAGES
Standard SimpleClean™ IVD Straight Jaws	1.5 mm			TWS 83-1003/95	TWS 83-1004/10	
	2 mm			TWS 83-1003/99	TWS 83-1004/11	
	3 mm			TWS 83-1004/00	TWS 83-1004/12	
	4 mm			TWS 83-1004/01	TWS 83-1004/13	
Weil-Blakesley SimpleClean™ IVD Straight Jaws	2.5 mm			TWS 83-1004/02	TWS 83-1004/14	
	3.5 mm			TWS 83-1004/03	TWS 83-1004/15	
Standard SimpleClean™ IVD Jaws Angled Upwards 30 Degrees	1.5 mm			TWS 83-1004/04	TWS 83-1004/16	
	2 mm			TWS 83-1004/05	TWS 83-1004/17	
	3 mm			TWS 83-1004/06	TWS 83-1004/18	
	4 mm			TWS 83-1004/07	TWS 83-1004/19	
Weil-Blakesley SimpleClean™ IVD Jaws Angled Upwards 45 Degrees	2.5 mm			TWS 83-1004/08	TWS 83-1004/20	
	3.5 mm			TWS 83-1004/09	TWS 83-1004/21	

*The TiAIN coating prevents light reflections, increases surface hardness, and ensures smooth gliding of the shaft components.

BAYONET IVD PITUITARY RONGEURS

TiAIN Coated*

TWS IVD Pituitary Rongeurs designed for use with MIS retraction portals or smaller incisions. Bayonet shape increases visibility to the operative site.

FAMILY	BITE SIZE	1:1	LENGTH 9"/230 mm	PRODUCT IMAGES
Straight Jaws	2 mm		TWS 83-1004/22	
	3 mm		TWS 83-1004/23	
	4 mm		TWS 83-1004/24	









*The TiAIN coating prevents light reflections, increases surface hardness, and ensures smooth gliding of the shaft components.



1:2 (9"/230 mm)

ADDITIONAL IVD PITUITARY RONGEURS













Specially Designed for Micro-Nucleotomy or Smaller Incisions

FAMILY	JAW WIDTH	1:1	LENGTH 8" / 200 mm	DESCRIPTION	PRODUCT IMAGES
Straight Jaws	1.5 mm		TWS 83-1004/25	Small bite; jaws gold plated	
	2 mm		TWS 83-1004/26	Extra sharp cutting jaws, total gold plated	
	2.5 mm		TWS 83-1004/27	Jaws gold plated	
Jaws Angled Up	1.5 mm		TWS 83-1004/28	Jaws angled upward 20 degrees	
	2.5 mm		TWS 83-1004/29	Jaws angled upward 20 degrees	
	2.5 mm		TWS 83-1004/30	Jaws angled upward 42 degrees	



CASPAR IVD RONGEURS

Jaws Fenestrated, With Teeth — Jaw Widths of 2 mm - 6 mm*

FAMILY	JAW WIDTH	1:1	LENGTH 7"/180 mm	LENGTH 9"/230 mm	LENGTH ** 14"/355 mm	PRODUCT IMAGES	
Straight Jaws	2 mm		TWS 83-1004/31	TWS 83-1004/41	TWS 83-1004/51		
	3 mm		TWS 83-1004/32	TWS 83-1004/42	TWS 83-1004/52		
	4 mm		TWS 83-1004/33	TWS 83-1004/43	TWS 83-1004/53		
	5 mm		TWS 83-1004/34	TWS 83-1004/44	TWS 83-1004/54		
	6 mm		TWS 83-1004/35	TWS 83-1004/45	TWS 83-1004/55		
Jaws Angled Up	2 mm		TWS 83-1004/36	TWS 83-1004/46	TWS 83-1004/56		
	3 mm		TWS 83-1004/37	TWS 83-1004/47	TWS 83-1004/57		
	4 mm		TWS 83-1004/38	TWS 83-1004/48	TWS 83-1004/58		
	5 mm		TWS 83-1004/39	TWS 83-1004/49	TWS 83-1004/59		
	6 mm		TWS 83-1004/40	TWS 83-1004/50	TWS 83-1004/60		

*Item numbers reflect stainless steel finish. Black TiAIN coating can be added as a special order item.



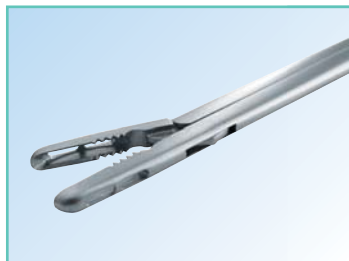

**14"/355 mm Lengths are available as special order items.



1:2 (7"/180 mm)

PEAPOD IVD RONGEURS













2 mm, 2.5 mm, and 3 mm Jaws Angled Up In a Length of 5.75"/145 mm

FAMILY	JAW WIDTH	1:1	LENGTH 5.75"/145 mm	PRODUCT IMAGES
Jaws Angled Up	2 mm		TWS 83-1004/61	
	2.5 mm		TWS 83-1004/62	
	3 mm		TWS 83-1004/63	























2:3 (5.75"/145 mm)

RUSKIN, BEYER, AND SCAGLIETTI BONE RONGEURS





DESCRIPTION	1:1	MODEL	PRODUCT IMAGES
Ruskin Bone Rongeur <ul style="list-style-type: none"> • Delicate Model • Double Action • Slightly Curved • Jaw Width 3.5 mm • Length 8" / 200 mm 		TWS 83-1004/64	
Beyer Bone Rongeur <ul style="list-style-type: none"> • Extra Delicate Jaws • Double Action • Slightly Curved • Jaw Width Tapers to 2 mm from 4 mm • Length 9" / 230 mm 		TWS 83-1004/65	
Scaglietti Bone Rongeur <ul style="list-style-type: none"> • Double Action • Slightly Curved • Jaw Width Tapers to 3.5 mm from 5 mm • Handle Angled Slightly to Side • Length 9.5" / 240 mm 		TWS 83-1004/66	
Angled Scaglietti Bone Rongeur <ul style="list-style-type: none"> • Double Action • Jaws Angled Forward • Jaw Width 5 mm • Length 9.5" / 240 mm 		TWS 83-1004/67	
Curved Scaglietti Bone Rongeur <ul style="list-style-type: none"> • Double Action • Jaws Curved to Side • Jaw Width 6 mm • Length 9.5" / 240 mm 		TWS 83-1004/68	
Left Scaglietti and Right Scaglietti Bone Rongeurs <ul style="list-style-type: none"> • Double Action • Jaws Angled Forward • Handle Curved to Left or Right • Jaw Width 6 mm • Length 10" / 255 mm 		TWS 83-1004/69 (handle to left) TWS 83-1004/70 (handle to right)	 

LEKSELL, STILLE BONE RONGEURS

DESCRIPTION	JAW WIDTH	1:1	MODEL	PRODUCT IMAGES
Bone Rongeur <ul style="list-style-type: none"> • Extra Long Model • Double Action • Long Neck • Jaw Curved to Side • Jaw Width 4, 6, and 8 mm • Length 13"/330 mm 	4 mm		TWS 83-1004/71	
	6 mm		TWS 83-1004/72	
	8 mm		TWS 83-1004/73	
Bone Rongeur <ul style="list-style-type: none"> • Same as Above Except Jaw Curved to Side and Forward 	4 mm		TWS 83-1004/74	
	6 mm		TWS 83-1004/75	
	8 mm		TWS 83-1004/76	
Leksell Bone Rongeur <ul style="list-style-type: none"> • Double Action • Jaws Slightly Curved to Side • Jaw Widths 3, 5, and 8 mm • Length 10"/255 mm 	3 mm		TWS 83-1004/77	
	5 mm		TWS 83-1004/78	
	8 mm		TWS 83-1004/79	
Dale-Leksell Bone Rongeur <ul style="list-style-type: none"> • Double Action • Extra Long Handle • Jaws Slightly Curved to Side • Jaw Widths 3, 5, and 8 mm • Length 14"/355 mm 	3 mm		TWS 83-1004/80	
	5 mm		TWS 83-1004/81	
	8 mm		TWS 83-1004/82	
Stille Bone Rongeur <ul style="list-style-type: none"> • Double Action • Jaws Angled to Side, Slightly Tapered • Jaw Widths 4, 5, and 6 mm • Length 9"/230 mm 	4 mm		TWS 83-1004/83	
	5 mm		TWS 83-1004/84	
	6 mm		TWS 83-1004/85	

CASPAR DISTRACTION SYSTEM

Aggravated by Caspar Distractors which ride up during surgery? The Caspar System uses innovative locking arms and long Caspar pins to resolve this problem.

FAMILY	DESCRIPTION	ITEM	PRODUCT IMAGES
Spreaders	<ul style="list-style-type: none"> • Spreads Right to 70 mm opening • Includes lock for Caspar Screws 	TWS 83-1004/86	
	<ul style="list-style-type: none"> • Spreads Left to 70 mm opening, • Includes lock for Caspar Screws 	TWS 83-1004/87	
Modified Distraction Screws	<ul style="list-style-type: none"> • 12 mm Reach • 90 mm Total Length 	TWS 83-1004/88	<p>Longer Caspar Pins serve to reduce pin splay, and to provide more secure, parallel distraction</p>  <p>1:1 (14 mm)</p>
	<ul style="list-style-type: none"> • 14 mm Reach • 92 mm Total Length 	TWS 83-1004/89	
	<ul style="list-style-type: none"> • 16 mm Reach • 94 mm Total Length 	TWS 83-1004/90	
Twist Drill with Handle	For surgeons who prefer to pre-drill their distraction screws	TWS 83-1004/91	
Caspar Screw Driver	10" / 255 mm Length including handle	TWS 83-1004/92	

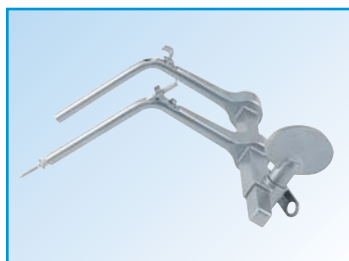



TW
Surgical

Treasure Wright (U.K.) Ltd.

**Address: 128-160 , City Road,
London EC1V 2NX. United Kingdom**

www.twrightmedical.com

info@twrightmedical.com



TW Surgical



**UK
CA CE**