

LONG HANDLE CURETTES



STRAIGHT



ANGLED



REV. ANGLED

LONG HANDLE CURETTES

15" overall length 9" handle 380mm 230mm handle

SIZE	STRAIGHT	ANGLED	REVERSE ANGLED
3/0	TWS 92-2300/30	TWS 92-2300/31	TWS 92-2300/32
2/0	TWS 92-2300/20	TWS 92-2300/21	TWS 92-2300/22
0	TWS 92-2300/00	TWS 92-2300/01	TWS 92-2300/02
1	TWS 92-2300/10	TWS 92-2300/11	TWS 92-2300/12
2	TWS 92-2300/23	TWS 92-2300/24	TWS 92-2300/25
3	TWS 92-2300/33	TWS 92-2300/34	TWS 92-2300/35
4	TWS 92-2300/40	TWS 92-2300/41	TWS 92-2300/42
5	TWS 92-2300/50	TWS 92-2300/51	TWS 92-2300/52
6	TWS 92-2300/60	TWS 92-2300/61	TWS 92-2300/62
7	TWS 92-2300/70	TWS 92-2300/71	TWS 92-2300/72

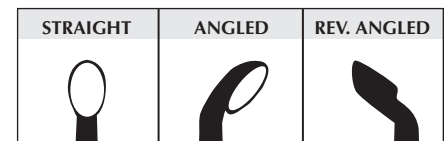

See page 11.1 for complete set information

Reverse Angle can be ordered special 90°

Smaller diameter handles available upon request on all Long Curettes.

STERILIZATION TRAY

Holds 20 Curettes

TWS 92-2300/03

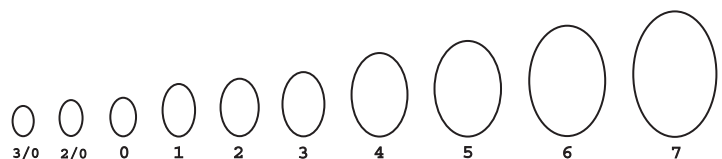



LONG CURETTES

15" overall length 7" handle 380mm 180mm handle

SIZE	STRAIGHT	ANGLED	REV. ANGLED
3/0	TWS 92-1800/30	TWS 92-1800/31	TWS 92-1800/41
2/0	TWS 92-1800/20	TWS 92-1800/32	TWS 92-1800/42
0	TWS 92-1800/00	TWS 92-1800/33	TWS 92-1800/43
1	TWS 92-1800/01	TWS 92-1800/34	TWS 92-1800/44
2	TWS 92-1800/02	TWS 92-1800/35	TWS 92-1800/45
3	TWS 92-1800/03	TWS 92-1800/36	TWS 92-1800/46
4	TWS 92-1800/04	TWS 92-1800/37	TWS 92-1800/47
5	TWS 92-1800/05	TWS 92-1800/38	TWS 92-1800/48
6	TWS 92-1800/06	TWS 92-1800/39	TWS 92-1800/49
7	TWS 92-1800/07	TWS 92-1800/40	TWS 92-1800/50



LONG CURETTE

13" overall length 7" handle 330mm 180mm handle

SIZE	STRAIGHT	ANGLED	REV. ANGLED
3/0	TWS 92-1801/30	TWS 92-1801/31	TWS 92-1801/41
2/0	TWS 92-1801/20	TWS 92-1801/32	TWS 92-1801/42
0	TWS 92-1801/00	TWS 92-1801/33	TWS 92-1801/43
1	TWS 92-1801/01	TWS 92-1801/34	TWS 92-1801/44
2	TWS 92-1801/02	TWS 92-1801/35	TWS 92-1801/45
3	TWS 92-1801/03	TWS 92-1801/36	TWS 92-1801/46
4	TWS 92-1801/04	TWS 92-1801/37	TWS 92-1801/47
5	TWS 92-1801/05	TWS 92-1801/38	TWS 92-1801/48
6	TWS 92-1801/06	TWS 92-1801/39	TWS 92-1801/49
7	TWS 92-1801/07	TWS 92-1801/40	TWS 92-1801/50

LATERAL ANGLE CURETTES



LATERAL ANGLE CURETTES

15" overall length 9" handle 380mm 230mm handle

SIZE	RIGHT	LEFT
2	TWS 92-2301/20	TWS 92-2301/21
4	TWS 92-2301/40	TWS 92-2301/41

CONE RING CURETTES



STRAIGHT



ANGLED



LATERAL ANGLE

CONE RING CURETTES

15" overall length 9" handle 380mm 230mm handle

SIZE	STRAIGHT	ANGLED	LATERAL ANGLED
1	TWS 92-2302/10	TWS 92-2302/11	TWS 92-2302/12
2	TWS 92-2302/20	TWS 92-2302/21	TWS 92-2302/22
3	TWS 92-2302/30	TWS 92-2302/31	TWS 92-2302/32
4	TWS 92-2302/40	TWS 92-2302/41	TWS 92-2302/42

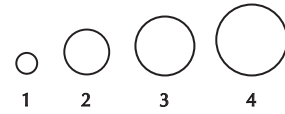

CONE RING CURETTES

15" overall length 7" handle 380mm 180mm handle

SIZE	STRAIGHT	ANGLED	LATERAL ANGLED
2	TWS 92-2302/23	TWS 92-2302/24	TWS 92-2302/25
3	TWS 92-2302/33	TWS 92-2302/34	TWS 92-2302/35
4	TWS 92-2302/43	TWS 92-2302/44	TWS 92-2302/45

O'BRIEN CURETTES



O'BRIEN CURETTES

15" overall length 9" handle 380mm 230mm handle

8mm	TWS 92-2309/08
11mm	TWS 92-2309/11



O'BRIEN CURETTES

15" overall length 7" handle 380mm 180mm handle

8mm	TWS 92-2309/18
11mm	TWS 92-2309/21

CHARNLEY CURETTES

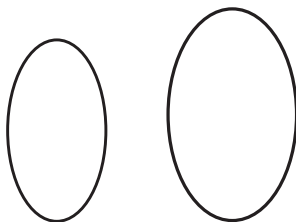

Small

Large

CHARNLEY CURETTES

15" overall length 9" handle 380mm 230mm handle

Small	TWS 92-2309/01
Large	TWS 92-2309/02

TRIANGLE ENDPLATE CURETTE



TRIANGLE ENDPLATE CURETTE
15" overall length 7" handle 380mm 180mm handle
11mm TWS 92-1802/11



TEARDROP CURETTE



TEARDROP CURETTE
15" overall length 9" handle 380mm 230mm handle
8mm TWS 92-1802/08
11mm TWS 92-1802/12



TEARDROP CURETTE
15" overall length 7" handle 380mm 180mm handle
10mm TWS 92-1802/10 slight curve



DOWN PUSHING CURETTE



DOWN PUSHING CURETTE
 15" overall length 9" handle 380mm 230mm handle

10mm x 5mm TWS 92-2303/15



DOWN PUSHING CURETTE
 15" overall length 7" handle 380mm 180mm handle

TWS 92-2303/16



TOOTHED LONG HANDLE CURETTES



TOOTHED LONG HANDLE CURETTES
 15" overall length 9" handle 380mm 230mm handle

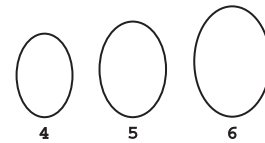

SIZE	STRAIGHT	ANGLED	LATERAL RIGHT	LATERAL LEFT
4	TWS 92-2303/40	TWS 92-2303/41	TWS 92-2303/42	TWS 92-2303/43
5	TWS 92-2303/50	TWS 92-2303/51	TWS 92-2303/52	TWS 92-2303/53
6	TWS 92-2303/60	TWS 92-2303/61	TWS 92-2303/62	TWS 92-2303/63



*Aggressive Teeth
 available upon request*

Curette available upon request.

AMERICAN CURETTES



STRAIGHT



ANGLED

AMERICAN CURETTES

10" overall length 5" handle 250mm 125mm handle

SIZE	STRAIGHT	ANGLED	REV. ANGLED
5/0	TWS 92-1250/50	TWS 92-1250/11	TWS 92-1250/22
4/0	TWS 92-1250/40	TWS 92-1250/12	TWS 92-1250/23
3/0	TWS 92-1250/30	TWS 92-1250/13	TWS 92-1250/24
2/0	TWS 92-1250/20	TWS 92-1250/14	TWS 92-1250/25
0	TWS 92-1250/00	TWS 92-1250/15	TWS 92-1250/26
1	TWS 92-1250/01	TWS 92-1250/16	TWS 92-1250/27
2	TWS 92-1250/02	TWS 92-1250/17	TWS 92-1250/28
3	TWS 92-1250/03	TWS 92-1250/18	TWS 92-1250/29
4	TWS 92-1250/04	TWS 92-1250/19	TWS 92-1250/31
5	TWS 92-1250/05	TWS 92-1250/21	TWS 92-1250/32

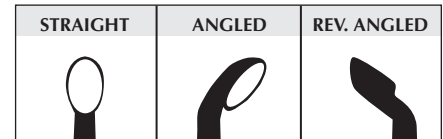

PEDICLE CURETTE



PEDICLE CURETTE

10" overall length 5" handle 250mm 125mm handle

Stop at 40mm

SIZE		
3/0	TWS 92-1250/33	 3/0

HALF CURETTE



AMERICAN HALF CURETTES

10" overall length 5" handle 250mm 125mm handle

Left #2/0 TWS 92-1251/20
 Right #2/0 TWS 92-1251/21



90° FWD Angle

MICRO HALF CURETTES

9.5" overall length 4.5" handle 240mm 110mm handle

Left #2/0 TWS 92-1251/22
 Right #2/0 TWS 92-1251/23



RING CURETTES



RING CURETTES

10" overall length 5" handle 250mm 125mm handle



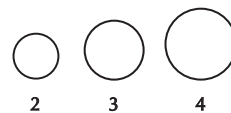



SIZE	STRAIGHT	ANGLED
2	TWS 92-1251/24	TWS 92-1251/25
3	TWS 92-1251/03	TWS 92-1251/13
4	TWS 92-1251/04	TWS 92-1251/14



RAINBOW CURETTES



AMERICAN RAINBOW
10" overall length 250mm

Color	Size	STR	ANG	REV ANG
 Aqua	6/0	TWS 92-2500/60	TWS 92-2500/61	TWS 92-2500/62
 Purple	4/0	TWS 92-2500/40	TWS 92-2500/41	TWS 92-2500/42
 Green	3/0	TWS 92-2500/30	TWS 92-2500/31	TWS 92-2500/32
 Red	2/0	TWS 92-2500/20	TWS 92-2500/21	TWS 92-2500/22
 Blue	0	TWS 92-2500/00	TWS 92-2500/01	TWS 92-2500/04
 Gold	2	TWS 92-2500/02	TWS 92-2500/03	TWS 92-2500/05

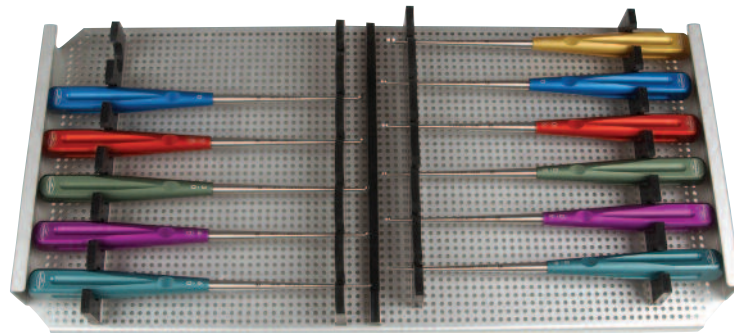

STERILIZATION CASE
Includes insert, outer case and lid
TWS 92-2500/06

MICRO RAINBOW CURETTES



MICRO RAINBOW
10" overall length 250mm

Color	Size	STR	ANG
Blue	6/0	TWS 92-2501/60	TWS 92-2501/61
Purple	4/0	TWS 92-2501/40	TWS 92-2501/41
Green	3/0	TWS 92-2501/30	TWS 92-2501/31
Red	2/0	TWS 92-2501/20	TWS 92-2501/21
Gold	0	TWS 92-2501/00	TWS 92-2501/01

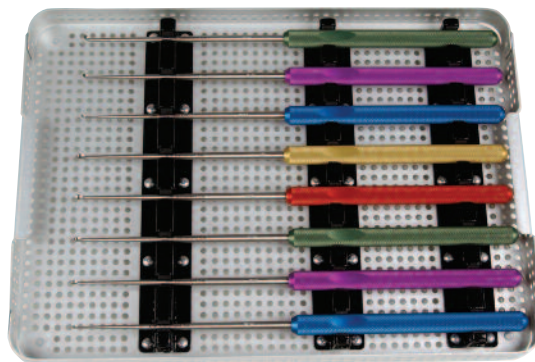

STERILIZATION CASE

2 level case, holds 10 currettes on insert, additional storage on bottom mat
TWS 92-2501/02

Treasure Wright (U.K.) Ltd.
128 City Road, London, EC1V 2NX, UK
info@twrightmedical.com

MICRO CURETTES



STRAIGHT



ANGLED

MICRO CURETTES

9.5" overall length 4.5" handle 240mm 110mm handle

SIZE	STRAIGHT	ANGLED	REV. ANGLED
6/0	TWS 92-1100/60	TWS 92-1100/61	TWS 92-1100/62
5/0	TWS 92-1100/50	TWS 92-1100/51	TWS 92-1100/52
4/0	TWS 92-1100/40	TWS 92-1100/41	TWS 92-1100/42
3/0	TWS 92-1100/30	TWS 92-1100/31	TWS 92-1100/32
2/0	TWS 92-1100/20	TWS 92-1100/21	TWS 92-1100/22
0	TWS 92-1100/00	TWS 92-1100/01	TWS 92-1100/02

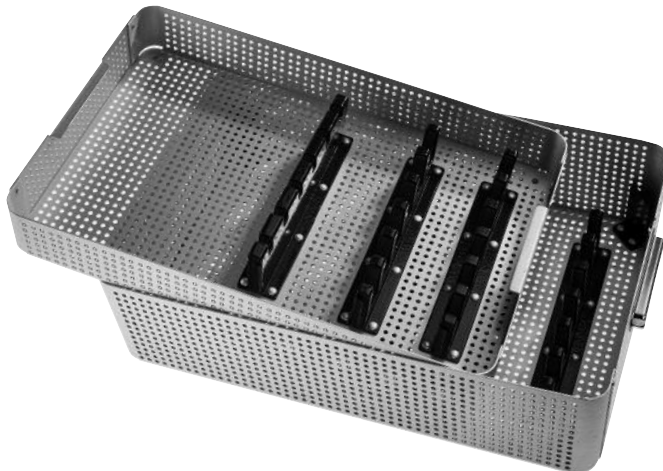
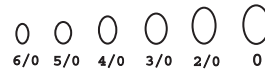
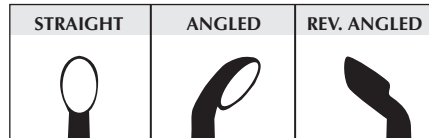

MICRO CURETTE STERILIZATION TRAY

Holds 12 Micro Curettes
Two Level Tray with Cover
6 Instruments on each level
Outer Dimensions: 14" x 9" x 4"

TWS 92-1100/03

MICRO AXIAL CURETTES



(TWS 92-1000/40)

MICRO AXIAL CURETTES
 9.5" overall length 4.5" handle 240mm
 4" working length 100mm

UP ORIENTATION						
	6/0	5/0	4/0	3/0	2/0	0
STR	TWS 92-100/60	TWS 92-100/50	TWS 92-100/40	TWS 92-100/30	TWS 92-100/20	TWS 92-100/00
ANG	TWS 92-100/61	TWS 92-100/51	TWS 92-100/41	TWS 92-100/31	TWS 92-100/21	TWS 92-100/01
REV ANG	TWS 92-100/62	TWS 92-100/52	TWS 92-100/42	TWS 92-100/32	TWS 92-100/22	TWS 92-100/02
DOWN ORIENTATION						
	6/0	5/0	4/0	3/0	2/0	0
STR	TWS 92-100/63	TWS 92-100/53	TWS 92-100/43	TWS 92-100/33	TWS 92-100/23	TWS 92-100/03
ANG	TWS 92-100/64	TWS 92-100/54	TWS 92-100/44	TWS 92-100/34	TWS 92-100/24	TWS 92-100/04
REV ANG	TWS 92-100/65	TWS 92-100/55	TWS 92-100/45	TWS 92-100/35	TWS 92-100/25	TWS 92-100/05

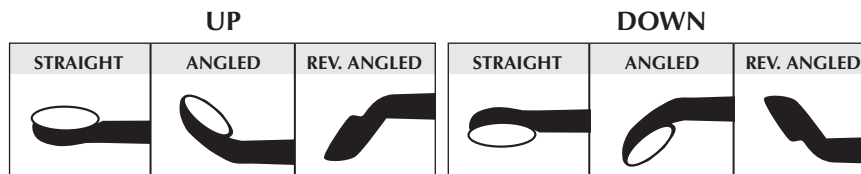

AXIAL CURETTE ORIENTATIONS



TWS 92-1001/00 STRAIGHT, UP

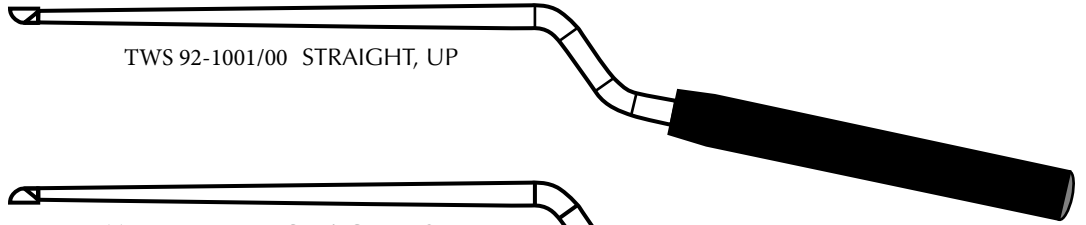

TWS 92-1001/01 STRAIGHT, DOWN

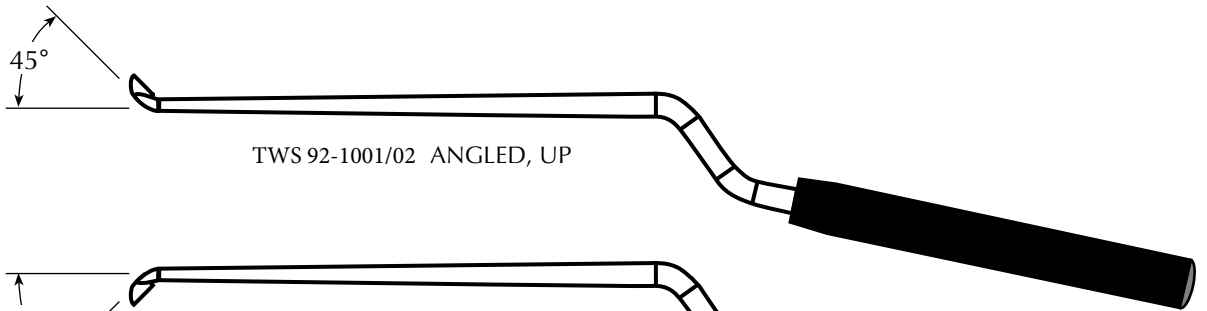
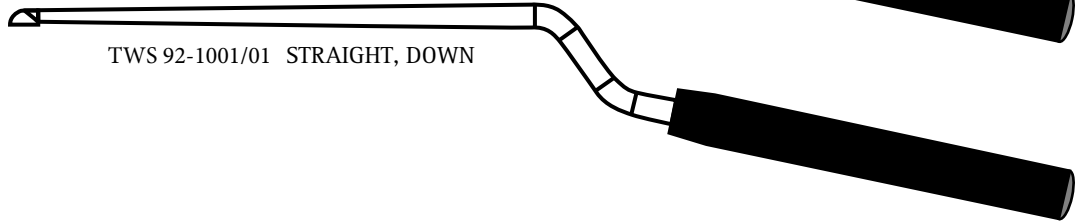

TWS 92-1001/02 ANGLED, UP

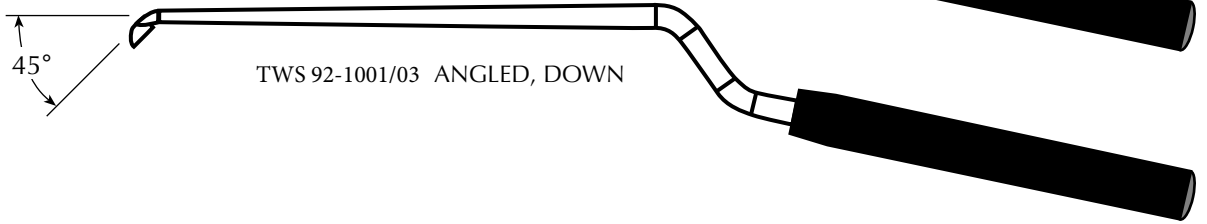

TWS 92-1001/03 ANGLED, DOWN

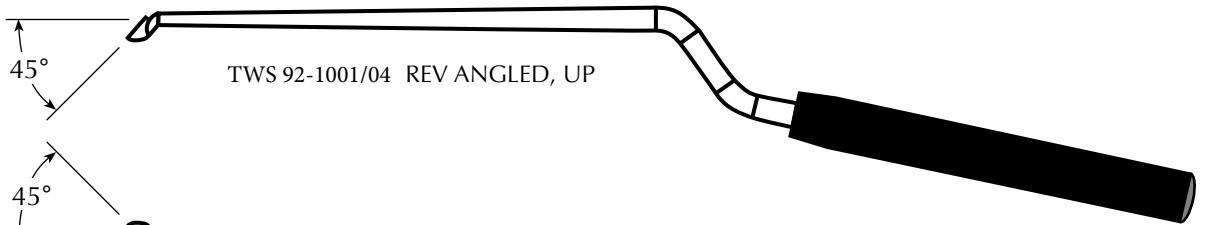

TWS 92-1001/04 REV ANGLED, UP

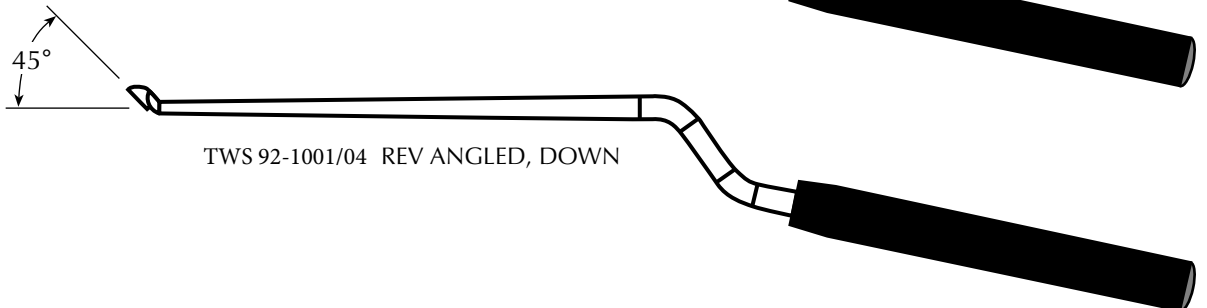

TWS 92-1001/04 REV ANGLED, DOWN

MICRO AXIAL DISCECTOMY CURETTES



(TWS 92-2502/24)



(TWS 92-2502/21)

MICRO AXIAL DISCECTOMY CURETTES

11.5" overall length 4.5" handle 250mm

6" working length 150mm



UP ORIENTATION						
	4/0	3/0	2/0	0	1	2
STR	TWS 92-252/40	TWS 92-252/30	TWS 92-252/20	TWS 92-252/00	TWS 92-252/06	TWS 92-252/12
ANG	TWS 92-252/41	TWS 92-252/31	TWS 92-252/21	TWS 92-252/11	TWS 92-252/07	TWS 92-252/13
REV ANG	TWS 92-252/42	TWS 92-252/32	TWS 92-252/22	TWS 92-252/12	TWS 92-252/08	TWS 92-252/14
DOWN ORIENTATION						
	4/0	3/0	2/0	0	1	2
STR	TWS 92-252/43	TWS 92-252/33	TWS 92-252/23	TWS 92-252/03	TWS 92-252/09	TWS 92-252/15
ANG	TWS 92-252/44	TWS 92-252/34	TWS 92-252/24	TWS 92-252/04	TWS 92-252/10	TWS 92-252/16
REV ANG	TWS 92-252/45	TWS 92-252/35	TWS 92-252/25	TWS 92-252/05	TWS 92-252/11	TWS 92-252/17

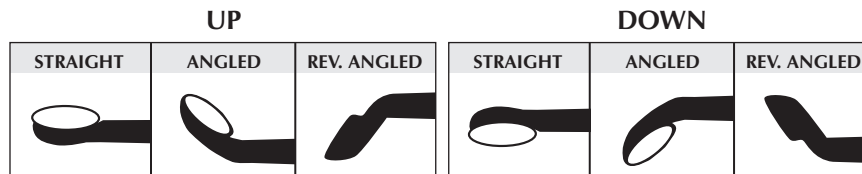

90° angles available upon request.

AXIAL DISCECTOMY CURETTES



AXIAL DISCECTOMY CURETTE

12.5" overall length 5" handle

6" working length 150mm Large Grip

UP ORIENTATION

SIZE	STRAIGHT	ANGLED	REV ANGLED
4	TWS 92-1500/40	TWS 92-1500/41	TWS 92-1500/42

DOWN ORIENTATION

SIZE	STRAIGHT	ANGLED	REV ANGLED
4	TWS 92-1500/43	TWS 92-1500/44	TWS 92-1500/45



THORACIC CURETTES



THORACIC CURETTES

15" overall length 5" handle 380mm Low Profile Design

SIZE	STRAIGHT	ANGLED
2	TWS 92-1500/46	TWS 92-1500/47
3	TWS 92-1500/48	TWS 92-1500/49
4	TWS 92-1500/50	TWS 92-1500/51

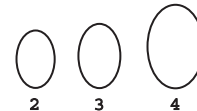

Custom angles available upon request.

THORACIC RING CURETTES



THORACIC RING CURETTES

15" overall length 5" handle 380mm Low Profile Design

SIZE	STRAIGHT	ANGLED
2	TWS 92-1500/52	TWS 92-1500/53
3	TWS 92-1500/54	TWS 92-1500/55
4	TWS 92-1500/56	TWS 92-1500/57

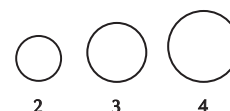

CURETTES



TEARDROP CURETTE
11.5" overall length 4.5" handle

6mm TWS 92-1150/01



SLOTTED TEETH CURETTE
11.5" overall length 4.5" handle

#5 TWS 92-1150/02

LATERAL BAYONET CURETTES



BAYONET CUP



BAYONET RING



BAYONET TEARDROP

BAYONET CUP CURETTE
18.5" overall length 7" handle 10" working length

SIZE	STRAIGHT UP	ANGLED UP	REV ANGLED DOWN
2	TWS 92-1150/03	TWS 92-1150/04	TWS 92-1150/05
4	TWS 92-1150/06	TWS 92-1150/07	TWS 92-1150/08

Additional sizes available upon request.

BAYONET RING CURETTE
18.5" overall length 7" handle 10" working length

#3 TWS 92-1150/09

BAYONET TEARDROP CURETTE
18.5" overall length 7" handle 10" working length

8mm TWS 92-1150/18



TW Surgical

ANTERIOR CURETTES



ANTERIOR CURETTES

18" overall length 9" handle 460mm 230mm handle

SIZE	STRAIGHT	ANGLED
0	TWS 92-2304/00	TWS 92-2304/01
2	TWS 92-2304/20	TWS 92-2304/21
4	TWS 92-2304/40	TWS 92-2304/41
6	TWS 92-2304/60	TWS 92-2304/61

ANTERIOR RING CURETTE



ANTERIOR RING CURETTE

18" overall length 9" handle 460mm 230mm handle

SIZE	STRAIGHT	ANGLED
3	TWS 92-2304/30	TWS 92-2304/31

ANTERIOR RING CURETTES



ANTERIOR RING CURETTES

18" overall length 5" handle 460mm 125mm handle

SIZE	STRAIGHT	ANGLED
1	TWS 92-2304/10	TWS 92-2304/11
2	TWS 92-2304/22	TWS 92-2304/23
3	TWS 92-2304/32	TWS 92-2304/33
4	TWS 92-2304/42	TWS 92-2304/43

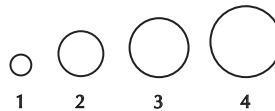

ANTERIOR CURETTES



ANTERIOR CURETTES

18" overall length 5" handle 460mm 125mm handle

SIZE	STRAIGHT	ANGLED
4/0	TWS 92-2304/44	TWS 92-2304/45
3/0	TWS 92-2304/34	TWS 92-2304/35
2/0	TWS 92-2304/24	TWS 92-2304/25
0	TWS 92-2304/04	TWS 92-2304/05

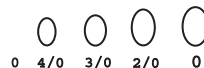

Treasure Wright (U.K.) Ltd.
 128 City Road, London, EC1V 2NX, UK
 info@twrightmedical.com

COBB CURETTES



TW Surgical



COBB CURETTES

11" overall length 280mm

SIZE	STRAIGHT	ANGLED
4/0	TWS 92-2801/40	TWS 92-2801/41
3/0	TWS 92-2801/30	TWS 92-2801/31
2/0	TWS 92-2801/20	TWS 92-2801/21
0	TWS 92-2801/01	TWS 92-2801/02
1	TWS 92-2801/03	TWS 92-2801/04
2	TWS 92-2801/05	TWS 92-2801/06
3	TWS 92-2801/07	TWS 92-2801/08
4	TWS 92-2801/09	TWS 92-2801/10
5	TWS 92-2801/11	TWS 92-2801/12
6	TWS 92-2801/13	TWS 92-2801/14

SCOVILLE DISC CURETTE



SCOVILLE DISC CURETTE

10" overall length 250mm

STRAIGHT	ANGLED	REV. ANGLED
TWS 92-2304/91	TWS 92-2304/92	TWS 92-2304/93

BRUN CURETTES



BRUN CURETTES

9" overall length 230mm

SIZE	STRAIGHT	ANGLED	REV. ANGLED
5/0	TWS 92-2304/50	TWS 92-2304/51	TWS 92-2304/52
4/0	TWS 92-2304/40	TWS 92-2304/41	TWS 92-2304/42
3/0	TWS 92-2304/30	TWS 92-2304/31	TWS 92-2304/32
2/0	TWS 92-2304/20	TWS 92-2304/21	TWS 92-2304/22
0	TWS 92-2304/00	TWS 92-2304/10	TWS 92-2304/16
1	TWS 92-2304/01	TWS 92-2304/11	TWS 92-2304/17
2	TWS 92-2304/02	TWS 92-2304/12	TWS 92-2304/18
3	TWS 92-2304/03	TWS 92-2304/13	TWS 92-2304/19
4	TWS 92-2304/04	TWS 92-2304/14	TWS 92-2304/29
5	TWS 92-2304/05	TWS 92-2304/15	TWS 92-2304/39

LONG HANDLE COBB ELEVATORS



LONG HANDLE COBB ELEVATORS

15" overall length 9" handle 380mm 230mm handle

SIZE	15" LENGTH
1/2"	TWS 92-2300/12
5/8"	TWS 92-2300/58
3/4"	TWS 92-2300/34
1"	TWS 92-2300/01
30mm	TWS 92-2300/30



LONG COBB ELEVATORS

13" overall length 7" handle 330mm 180mm handle

SIZE	13" LENGTH
1/2"	TWS 92-2301/12
5/8"	TWS 92-2301/58
3/4"	TWS 92-2301/34
1"	TWS 92-2301/01
30mm	TWS 92-2301/30

Custom lengths and widths available upon request.

Smaller diameter handles available upon request on all Cobb Elevators.



LONG COBB ELEVATORS

15" overall length 7" handle 380mm 180mm handle

SIZE	15" LENGTH
1/2"	TWS 92-2302/12
5/8"	TWS 92-2302/58
3/4"	TWS 92-2302/34
1"	TWS 92-2302/01
30mm	TWS 92-2302/30

SHOVEL NOSE ELEVATORS



SHOVEL NOSE ELEVATORS

	15" LENGTH 380mm	13" LENGTH 330mm
SIZE	9" handle 230mm	7" handle 180mm
5/8"	TWS 92-2303/58	TWS 92-2303/59
3/4"	TWS 92-2303/34	TWS 92-2303/35

FLAT COBB ELEVATORS



LONG HANDLE FLAT COBB ELEVATORS

15" overall length 9" handle 380mm 230mm handle

SIZE	15" LENGTH
1/2"	TWS 92-2304/12
5/8"	TWS 92-2304/58
3/4"	TWS 92-2304/34
1"	TWS 92-2304/01
30mm	TWS 92-2304/30



FLAT COBB ELEVATORS

	15" LENGTH 380mm 8" working length 7"	13" LENGTH 330mm 6" working length 7"
SIZE	handle 180mm	handle 180mm
1/2"	TWS 92-1800/12	TWS 92-1800/13
5/8"	TWS 92-1800/58	TWS 92-1800/59
3/4"	TWS 92-1800/34	TWS 92-1800/35
1"	TWS 92-1800/01	TWS 92-1800/02
30mm	TWS 92-1800/30	TWS 92-1800/31

FLAT COBB ELEVATORS



LONG FLAT COBB ELEVATOR 18" overall length 5" handle

SIZE

1/2" TWS 92-1801/12 60mm Flat

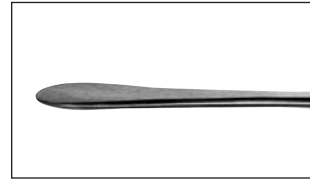

LONG FLAT ANGLED COBB ELEVATOR 17" overall length 7" handle

TWS 92-1801/13 Forward Angle 15° at 60mm
TWS 92-1801/14 Reverse Angle 15° at 60mm (shown)



FLAT COBB ELEVATORS 10" overall length 5" handle 250mm 125mm handle

SIZE	10" LENGTH
1/4"	TWS 92-1801/15
3/8"	TWS 92-1801/16
1/2"	TWS 92-1801/17

ENDPLATE SCRAPER



ENDPLATE SCRAPER
15" overall length 7" handle
380 mm 180 mm handle

TWS 92-1801/19

SMALL ELEVATORS



SMALL ELEVATORS
10" overall length 5" handle 250mm

SIZE

1/4"	TWS 92-1801/04
3/8"	TWS 92-1801/05
1/2"	TWS 92-1801/06
3/4"	TWS 92-1801/07

CURVED CHISEL & ELEVATOR



CURVED CHISEL & ELEVATOR
7 3/4" overall length 195mm

TWS 92-1801/08

Excellent for removing tissue on bone grafts.

PENFIELD DISSECTORS



PENFIELD #2



PENFIELD #3



PENFIELD #4

PENFIELD DISSECTORS 8.5" overall length 215mm

SIZE

#2	TWS 92-2150/02
#3	TWS 92-2150/03
#4	TWS 92-2150/04
3mm #4	TWS 92-2150/05



LONG PENFIELD #2



LONG PENFIELD #3



LONG PENFIELD #4

LONG PENFIELD DISSECTORS 10.5" overall length 265mm

SIZE

#2	TWS 92-2150/06
#3	TWS 92-2150/07
#4	TWS 92-2150/08

All penfields have black knurled handle for better feel and control.

WOODSON ELEVATORS



WOODSON ELEVATORS
8.5" overall length 215mm
TWS 92-2150/09

10.5" overall length 265mm
TWS 92-2150/10

NEIDRE ELEVATOR



NEIDRE ELEVATOR
10.5" overall length 265mm Double Ended Woodson and Dissector

TWS 92-2150/11

FELLRATH P.L.L. KNIFE



FELLRATH P.L.L. KNIFE SHARP
8.5" length 215mm
TWS 92-2150/12

11" length 280mm
TWS 92-2150/13

13" length 330mm
TWS 92-2150/14

CURVED KNIFE



CURVED KNIFE
8.5" overall length 215mm
TWS 92-2150/15

Sharp on the underside
Blunt Tip



IMPACTORS

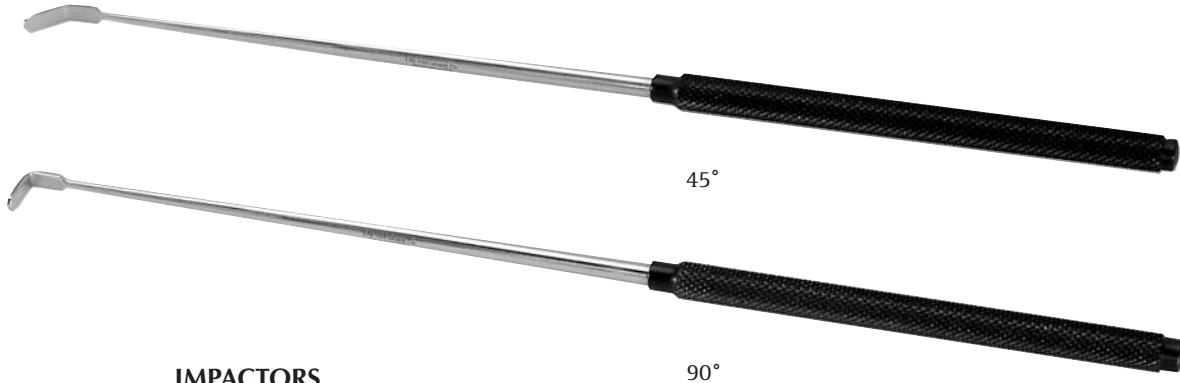

IMPACTORS
10.5" overall length 265mm

45° TWS 92-2150/16
90° TWS 92-2150/17

Serrated bottom available upon request.

DURAL SEPARATORS



DURAL SEPARATORS
8.5" overall length 215mm

TWS 92-2150/18
TWS 92-2150/19 With Groove



PENFIELD CUP CURETTE #1



PENFIELD CUP CURETTE #1
8.5" overall length 215mm

TWS 92-2150/20

MICRO COBB ELEVATORS



7.5 mm



4 mm



3 mm

MICRO COBB ELEVATORS 8.5" overall length 215mm

SIZE	8.5" LENGTH
3mm	TWS 92-2150/21
4mm	TWS 92-2150/22
7.5mm	TWS 92-2150/23
2mm	TWS 92-2150/24 (not shown)

Excellent for dissecting the ligamentum flavum.

FLAT MICRO COBB ELEVATORS



FLAT MICRO COBB ELEVATORS 8.5" overall length 215mm

SIZE	8.5" LENGTH
4mm	TWS 92-2150/25
7.5mm	TWS 92-2150/26

FULL CURVE DISSECTOR



FULL CURVE DISSECTOR

TWS 92-2150/27

Helpful in Revision Surgery.

CERVICAL ENDPLATE SCRAPER



CERVICAL ENDPLATE SCRAPER

8.5" overall length 215mm

5mm TWS 92-2150/28

WATSON CHAIN ELEVATOR



WATSON CHAIN ELEVATOR

DOUBLE ENDED

7.5" overall length 190mm

TWS 92-2150/29

HOWORTH ELEVATOR



HOWORTH ELEVATOR

DOUBLE ENDED

8.75" overall length 220mm

TWS 92-2150/30

SPINE DISSECTION KIT

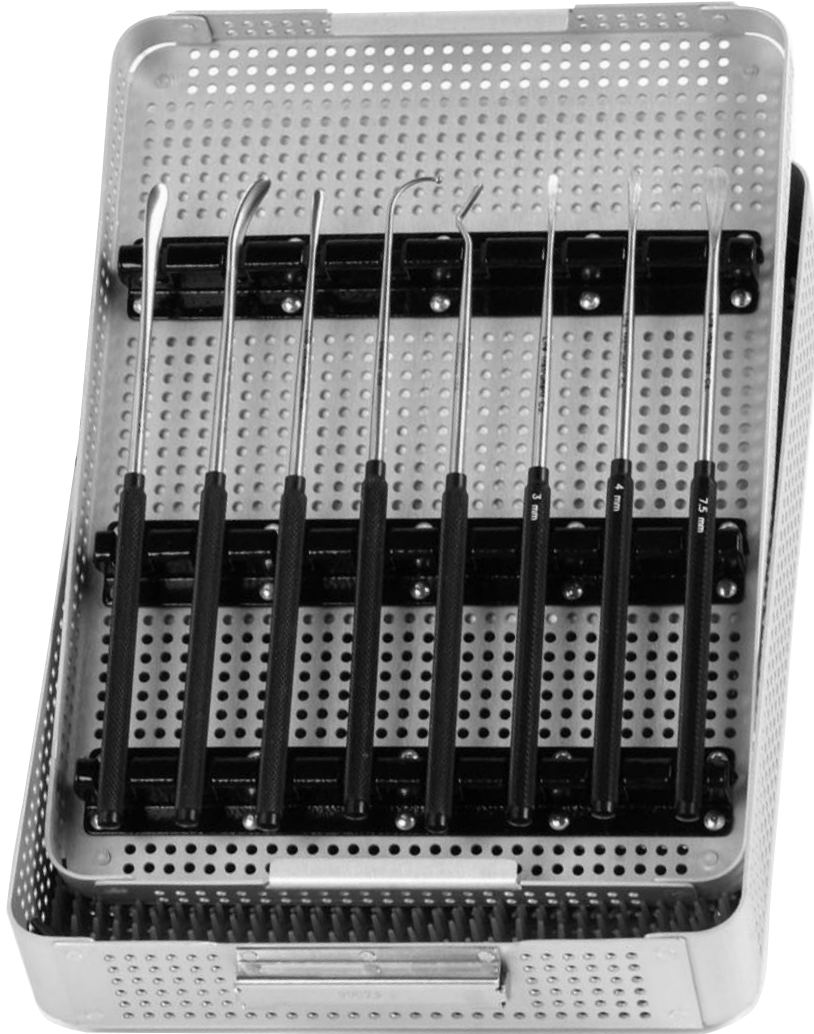

SPINE DISSECTION KIT #725-8000-1

Catalog #	Quantity	Description
TWS 92-80/01	1	Penfield Dissector #2
TWS 92-80/02	1	Penfield Dissector #3
TWS 92-80/03	1	Penfield Dissector #4
TWS 92-80/04	1	Murphy Ball Hook*
TWS 92-80/05	1	Woodson Elevator
TWS 92-80/06	1	Micro Cobb Elevators 3mm
TWS 92-80/07	1	Micro Cobb Elevators 4mm
TWS 92-80/08	1	Micro Cobb Elevators 7.5mm
TWS 92-80/09	1	2 Level Sterilization 12" x 8" Tray

/

LANGENBECK ELEVATOR



LANGENBECK ELEVATOR
9" overall length 230mm

TWS 92-2305/01

MICRO AXIAL DISSECTORS



MICRO AXIAL PENFIELD DISSECTORS
9.5" overall length 4" working length 240mm

SIZE

2mm	TWS 92-2305/02
3mm	TWS 92-2305/03
4mm	TWS 92-2305/04

MICRO AXIAL COBB ELEVATORS
9.5" overall length 4" working length 240mm
Sharp Edge

SIZE

2mm	TWS 92-2305/05
3mm	TWS 92-2305/06
4mm	TWS 92-2305/07

AXIAL DISSECTOMY INSTRUMENTS



AXIAL PENFIELD DISSECTOR

11.5" overall length 290mm

6" working length 150mm

SIZE

#2	TWS 92-2900/02	7.5mm Tip Slight Curve
#3	TWS 92-2900/03	7.5mm Full Curve
#4	TWS 92-2900/04	4mm Slight Curve
1.2mm	TWS 92-2900/05	Flat
2mm	TWS 92-2900/06	Curved Up



AXIAL MICRO COBB ELEVATOR

11.5" overall length 290mm

6" working length 150mm

4mm	TWS 92-2900/07	Sharp
-----	----------------	-------



AXIAL WOODSON ELEVATOR

11.5" overall length 290mm

6" working length 150mm

TWS 92-2900/08

ANTERIOR COBB ELEVATORS



ANTERIOR COBB ELEVATOR
18" overall length 9" handle
460mm 230mm handle

SIZE	
3/4"	TWS 92-2306/01
1"	TWS 92-2306/02

FLAT ANTERIOR COBB ELEVATORS
18" overall length 9" handle
460mm 230mm handle

SIZE	18" LENGTH	
3/4"	TWS 92-2306/03	Flat Tip
1"	TWS 92-2306/04	Flat Tip



ANTERIOR COBB ELEVATORS
18" overall length 5" handle 460mm

SIZE	18" LENGTH
3/8"	TWS 92-2306/05
1/2"	TWS 92-2306/06

ANULUS CUTTING KNIFE



ANULUS CUTTING KNIFE
18" overall length 5" handle 460mm

TWS 92-2306/07

ANTERIOR PENFIELD DISSECTOR #4



ANTERIOR PENFIELD DISSECTOR #4
16.5" overall length 420mm

TWS 92-2306/08

SUCTION LONG HANDLE COBB ELEVATOR



SUCTION LONG HANDLE COBB ELEVATOR 15" overall length 380mm 9" handle 230mm

3/4"	TWS 92-2306/09	Suction Left
3/4"	TWS 92-2306/10	Suction Right

BAYONET ANULUS CUTTING KNIFE



BAYONET ANULUS CUTTING KNIFE 18.5" overall length 7" handle

TWS 92-2306/11

LATERAL BAYONET PENFIELD DISSECTOR



LATERAL BAYONET PENFIELD DISSECTOR 16" overall length 10" working length 250mm

TWS 92-2306/12

COBB ELEVATORS



COBB ELEVATORS

11" overall length 280mm

9" overall length 230mm

SIZE	11" LENGTH
1/4"	821-1114-0
3/8"	821-1138-0
1/2"	821-1112-0
3/4"	821-1134-0
1"	821-1101-0

SIZE	9" LENGTH
1/4"	TWS 92-2307/01
1/2"	TWS 92-2307/02
3/4"	TWS 92-2307/03
1"	TWS 92-2307/04

FREER ELEVATOR



FREER ELEVATOR

7.5" double ended 190mm

4mm 726-7514-0

KEY PERIOSTEAL ELEVATORS



KEY PERIOSTEAL ELEVATORS

SIZE	LENGTH	
1/8"	6.34"	822-6718-0
1/4"	6.34"	822-6714-0
3/8"	7.5"	822-7538-0
1/2"	7.5"	822-7512-0
5/8"	7.5"	822-7558-0
3/4"	8"	822-0834-0
1"	8"	822-0801-0

MINI RASP



MINI RASP
7 3/4" overall length 6mm tip

TWS 99-7034/01

FORAMINAL RASP



FORAMINAL RASP
10.5" overall length

TWS 99-7034/02

ENDPLATE RASP



ENDPLATE RASP
15" overall length 7" handle

1/2" TWS 99-7034/03

ANTERIOR RASP
18" overall length 9" handle

TWS 99-7034/04

BAYONET RASP



BAYONET RASP
18" overall length 7" handle

TWS 99-7034/05

ZELPI® RETRACTORS

The Zelpi Retractor features a unique locking mechanism that guarantees against slipping and provides a 5" minimum exposure. The Zelpi comes with varying length arms to accommodate differing patient anatomy. The varying length arms provide limited pressure on muscles and tissues to help reduce tissue necrosis. The blades are angled at 90°. This design is low profile, providing less bulk in the surgeon's work area than the conventional crank retractors.

The Zelpi Retractors are cost effective, eliminating the cost of expensive multi blade retractor systems.

Left Handed Zelpi Retractors available upon request. Zelpis can be ordered with the locking mechanism reversed for easier use for a left handed person.



Also available

1.5"	TWS 80-9000/30
2"	TWS 80-9000/40

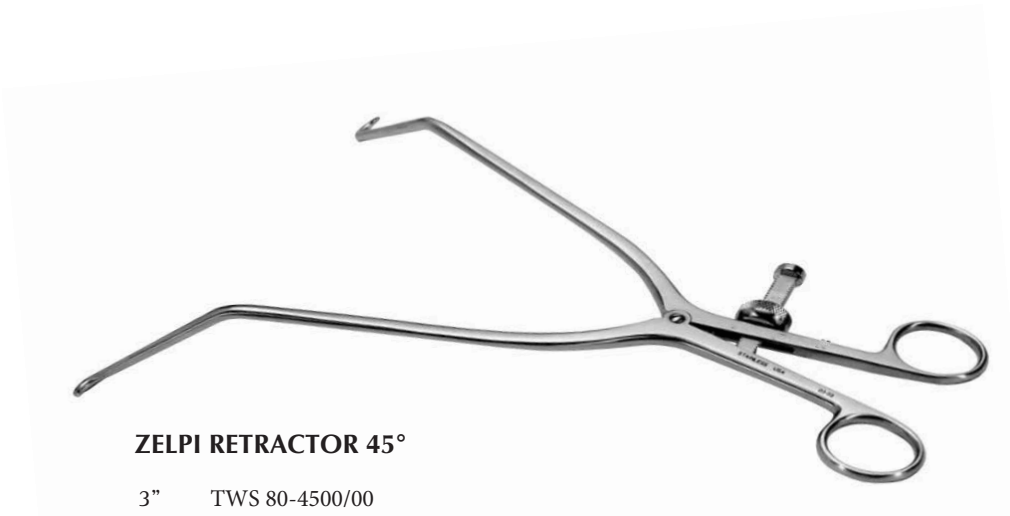

Excellent for use in the sacral or thoracic region.

LATERAL PLIF RETRACTORS

The Lateral Plif Retractor provides greater exposure enabling the surgeon to retract past the transverse process. The retractor comes with a tommy bar wrench that assists with extra torque to attain the 7" maximum exposure.



LATERAL PLIF RETRACTORS 7" Maximum Exposure

3" 90°	TWS 80-7000/00
4" 90°	TWS 80-7000/10
Wrench	TWS 80-7000/20

ZELPI® RETRACTORS



ZELPI WITH CEREBELLAR TIPS
90° 3.5" Length

3.5" TWS 80-3500/00

2.5" TWS 80-3500/10

3" TWS 80-3500/20

4" TWS 80-3500/30

5" TWS 80-3500/40

6" TWS 80-3500/50



ZELPI WITH CEREBELLAR TIPS
45° 3.5" Length

TWS 80-3501/00



TW Surgical

OFFSET ZELPI RETRACTORS



OFFSET ZELPI RETRACTORS

2.5" Right x 5" Left TWS 80-2500/00
2.5" Left x 5" Right TWS 80-2500/10

DOUBLE PRONG ZELPI RETRACTOR

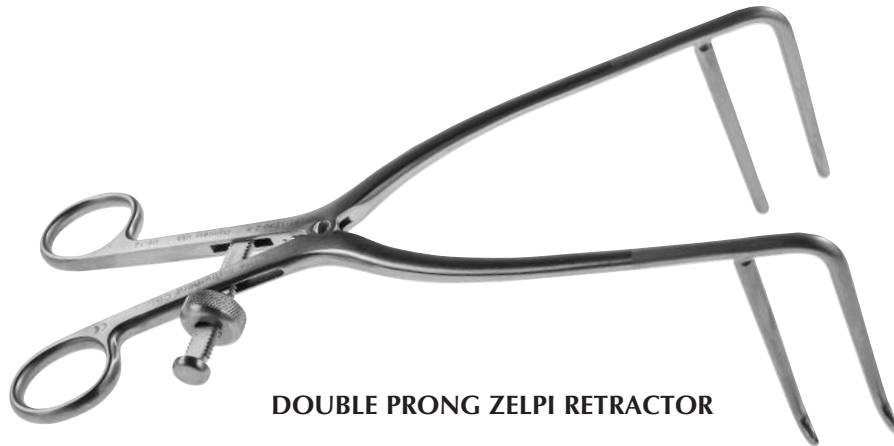

DOUBLE PRONG ZELPI RETRACTOR

3" Deep TWS 80-2501/00

DEEP ZELPI RETRACTOR

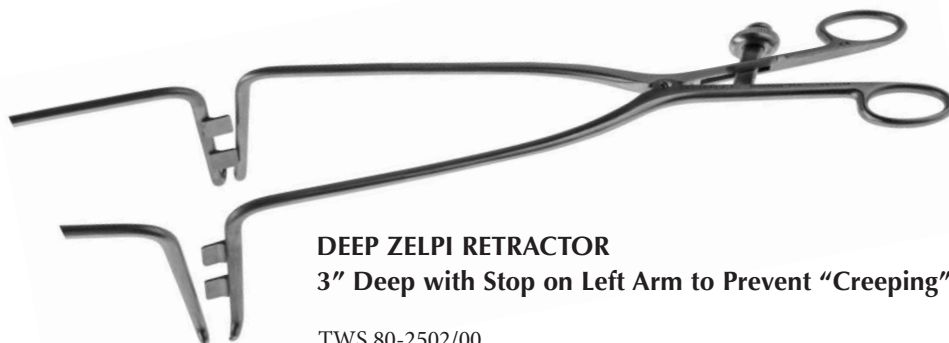

DEEP ZELPI RETRACTOR

3" Deep with Stop on Left Arm to Prevent "Creeping"

TWS 80-2502/00



TW Surgical

GELPI RETRACTORS

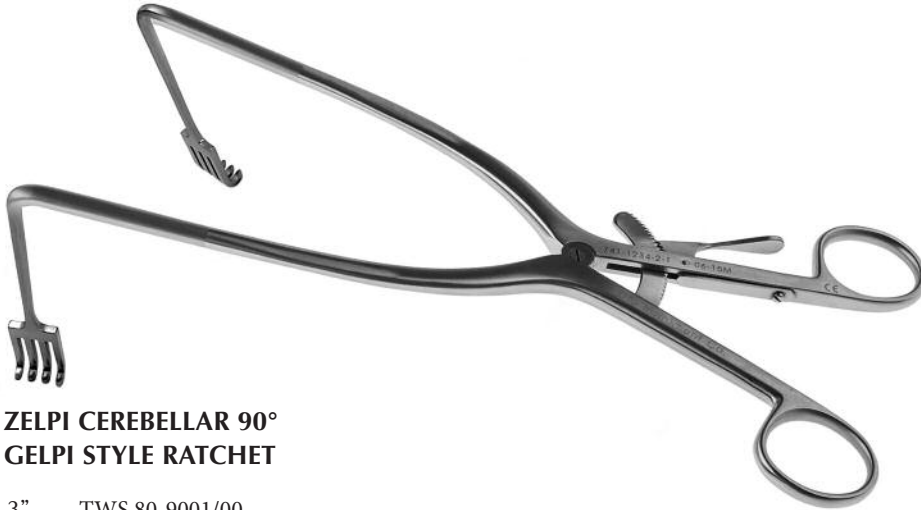

**ZELPI CEREBELLAR 90°
GELPI STYLE RATCHET**

3" TWS 80-9001/00



WILTSE GELPI RETRACTOR 4'''

TWS 80-9002/00



GELPI RETRACTOR WITH CEREBELLAR TIPS

TWS 80-9003/00

LARGE GELPI RETRACTOR



LARGE GELPI RETRACTOR

3" TWS 80-7001/00 70°

DEEP GELPI RETRACTOR 3"3"



DEEP GELPI RETRACTOR 3"

90° TWS 80-9004/00

MISKIMMON RETRACTOR

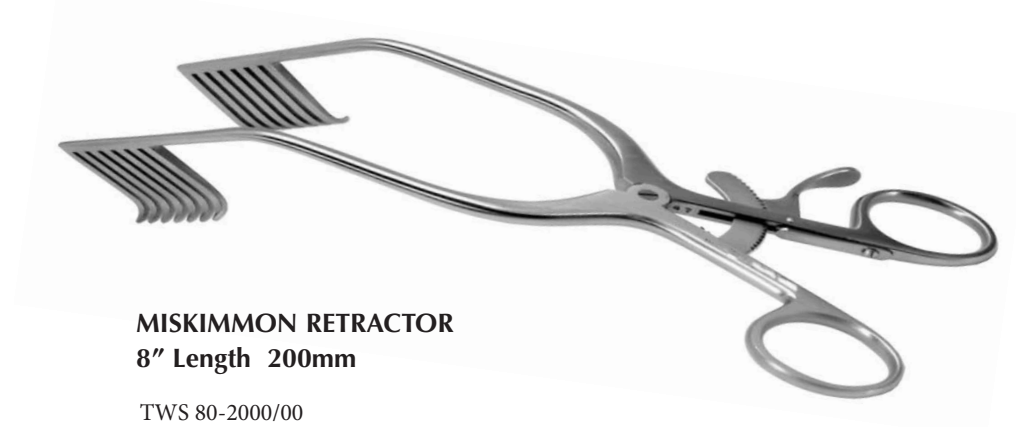

MISKIMMON RETRACTOR
8" Length 200mm

TWS 80-2000/00



TW Surgical

MEYERDING RETRACTOR



MEYERDING RETRACTOR
7.5" Length 190mm

2 3/8" x 1" (60 x 25mm) TWS 80-1900/00

GELPI RETRACTOR

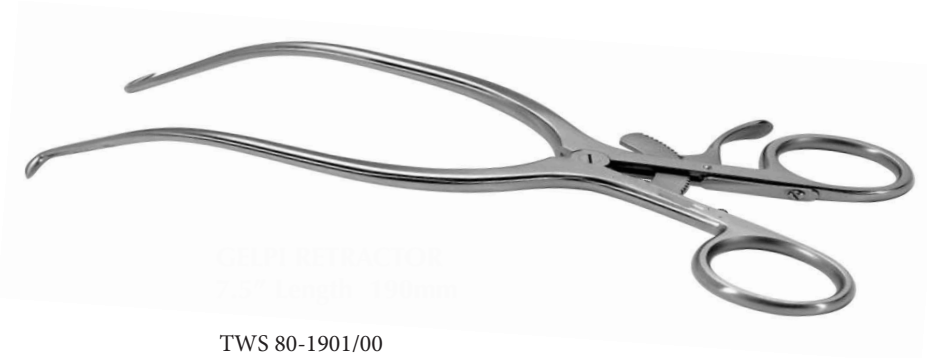

TWS 80-1901/00

WEITLANDER RETRACTORS



WEITLANDER RETRACTORS
3 x 4 prongs

SIZE

5 1/2"	TWS 80-3400/00
6 1/2"	TWS 80-3400/10
7 3/4"	TWS 80-3400/20
9"	TWS 80-3400/30



TW Surgical

ADSON CEREBELLAR RETRACTORS

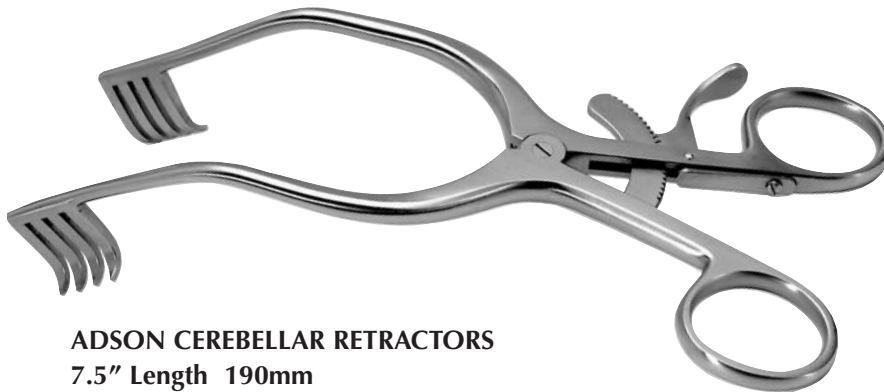

ADSON CEREBELLAR RETRACTORS
7.5" Length 190mm

Sharp TWS 80-1902/00
Blunt TWS 80-1902/10

ANGLED ADSON CEREBELLAR RETRACTORS



ANGLED ADSON CEREBELLAR RETRACTORS
Sharp Tips

60° TWS 80-6000/00
90° TWS 80-9004/00





TW Surgical

WILLIAMS RETRACTORS



WILLIAMS RETRACTORS Micro Dissectomy Retractor

SIZE

10mm x 70mm Left	TWS 80-7002/00
10mm x 70mm Right	TWS 80-7002/10
20mm x 70mm Left	TWS 80-7002/20
20mm x 70mm Right	TWS 80-7002/30

SIZE

10mm x 50mm Left	TWS 80-7002/01
10mm x 50mm Right	TWS 80-7002/11
20mm x 50mm Left	TWS 80-7002/21
20mm x 50mm Right	TWS 80-7002/31

DUCKER RETRACTORS

Left/Right denotes blade side



DUCKER RETRACTORS

50mm x 20mm Left	TWS 80-5000/00
50mm x 20mm Right	TWS 80-5000/10
70mm x 20mm Left	TWS 80-5000/20
70mm x 20mm Right	TWS 80-5000/30

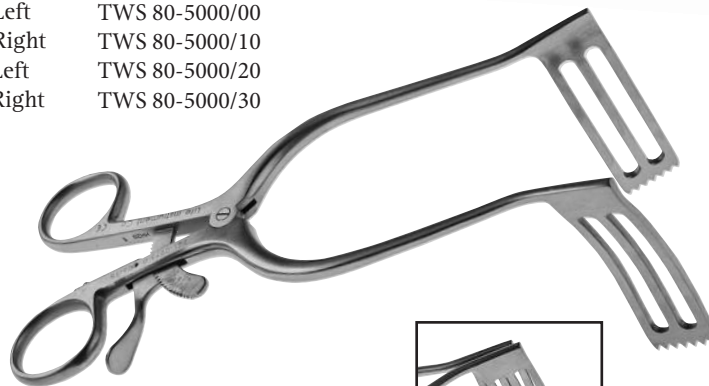

DOUBLE DUCKER RETRACTORS Double open blade - Interlocking

60mm x 21mm	TWS 80-6000/00
73mm x 21mm	TWS 80-6000/10
90mm x 21mm	TWS 80-6000/20





TW Surgical

ILIAC CREST RETRACTORS



ILIAC CREST RETRACTORS

Adult	TWS 80-6001/00
Pediatric	TWS 80-6001/10

MCELROY RETRACTORS



MCELROY RETRACTORS

5" depth 125mmmm

SIZE

9"	TWS 80-1250/00
11"	TWS 80-1250/10
13"	TWS 80-1250/20

MEYERDING RETRACTORS

MEYERDING RETRACTORS

SIZE

17mm x 55mm	TWS 80-1700/00
25mm x 80mm	TWS 80-1700/10
25mm x 125mm	TWS 80-1700/20
25mm x 150mm	TWS 80-1700/30
50mm x 94mm	TWS 80-1700/40



RIGHT ANGLE RETRACTORS



RIGHT ANGLE RETRACTORS

4"	TWS 80-1701/00
6"	TWS 80-1702/00
8"	TWS 80-1703/00

Handle can be 90° reversed upon request.

TAYLOR RETRACTORS



MICRO TAYLOR RETRACTORS

Blade width *only* 3/4" 19mm

SIZE

2"	50mm	TWS 80-1900/00
3"	75mm	TWS 80-1900/10
4"	100mm	TWS 80-1900/20
5"	125mm	TWS 80-1900/30
6"	150mm	TWS 80-1900/40



CONCAVE MICRO TAYLOR RETRACTOR

3"	TWS 80-1901/00
4"	TWS 80-1900/10



FIBEROPTIC MICRO TAYLOR RETRACTORS

3"	75mm	TWS 80-1902/00
4"	100mm	TWS 80-1902/10

ACMI Fitting



TAYLOR RETRACTORS

Blade width 1 1/4" 30mm

3"	75mm	TWS 80-3000/00
4"	100mm	TWS 80-3000/10
6"	150mm	TWS 80-3000/20



TW Surgical

RADIOLUCENT PEEK CERVICAL RETRACTOR SYSTEM



RADIOLUCENT PEEK CERVICAL RETRACTOR SYSTEM

TWS 80-3001/00

*** Quick Connect Feature Holds Blade in Frame ***

Catalog #	Quantity	Description
TWS 80-3001/10	1	Transverse Retractor Frame Double Hinged Arms with Peek Connector
TWS 80-3001/20	1	Longitudinal Counter Retractor Frame Double Hinged Arms with Peek Connector
TWS 80-3001/30	2	Peek Blade Toothed 30mm
TWS 80-3001/40	2	Peek Blade Toothed 35mm
TWS 80-3001/50	2	Peek Blade Toothed 40mm
TWS 80-3001/60	2	Peek Blade Toothed 45mm
TWS 80-3001/70	2	Peek Blade Toothed 50mm
TWS 80-3001/80	2	Peek Blade Toothed 55mm
TWS 80-3001/80	2	Peek Blade Toothed 60mm
TWS 80-3001/90	2	Peek Blade Toothed 65mm
TWS 80-3001/01	2	Peek Blade Blunt 30mm
TWS 80-3001/11	2	Peek Blade Blunt 35mm
TWS 80-3001/21	2	Peek Blade Blunt 40mm
TWS 80-3001/31	2	Peek Blade Blunt 45mm
TWS 80-3001/41	2	Peek Blade Blunt 50mm
TWS 80-3001/51	2	Peek Blade Blunt 55mm
TWS 80-3001/61	2	Peek Blade Blunt 60mm
TWS 80-3001/71	2	Peek Blade Blunt 65mm
TWS 80-3001/81	2	Blade Holders
TWS 80-3001/91	1	Sterilization Tray for Peek Cervical Retractor

Treasure Wright (U.K.) Ltd.
128 City Road, London, EC1V 2NX, UK
info@twrightmedical.com

CERVICAL INSTRUMENTS



PEEK BLADES

Non-rotating

	TOOTHED	E
30mm	TWS 80-3003/00	TV
35mm	TWS 80-3003/10	TV
40mm	TWS 80-3003/20	TV
45mm	TWS 80-3003/30	TV
50mm	TWS 80-3003/40	TV
55mm	TWS 80-3003/50	TV
60mm	TWS 80-3003/60	TV
65mm	TWS 80-3003/70	TV



TWS 80-3002/00

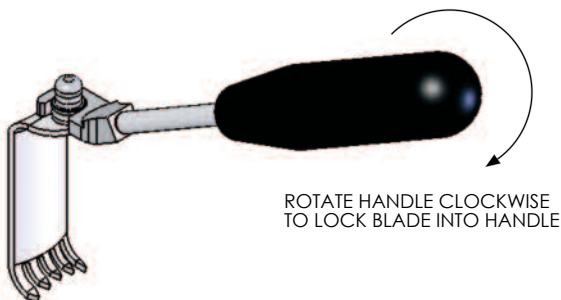

ROTATE HANDLE CLOCKWISE
TO LOCK BLADE INTO HANDLE

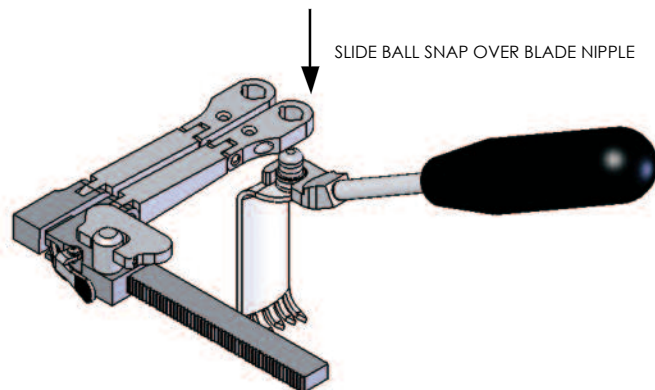

SLIDE BALL SNAP OVER BLADE NIPPLE

BLADE HOLDER

TWS 80-3004/00

SMALL RADIOLOGENT CERVICAL RETRACTOR SYSTEM

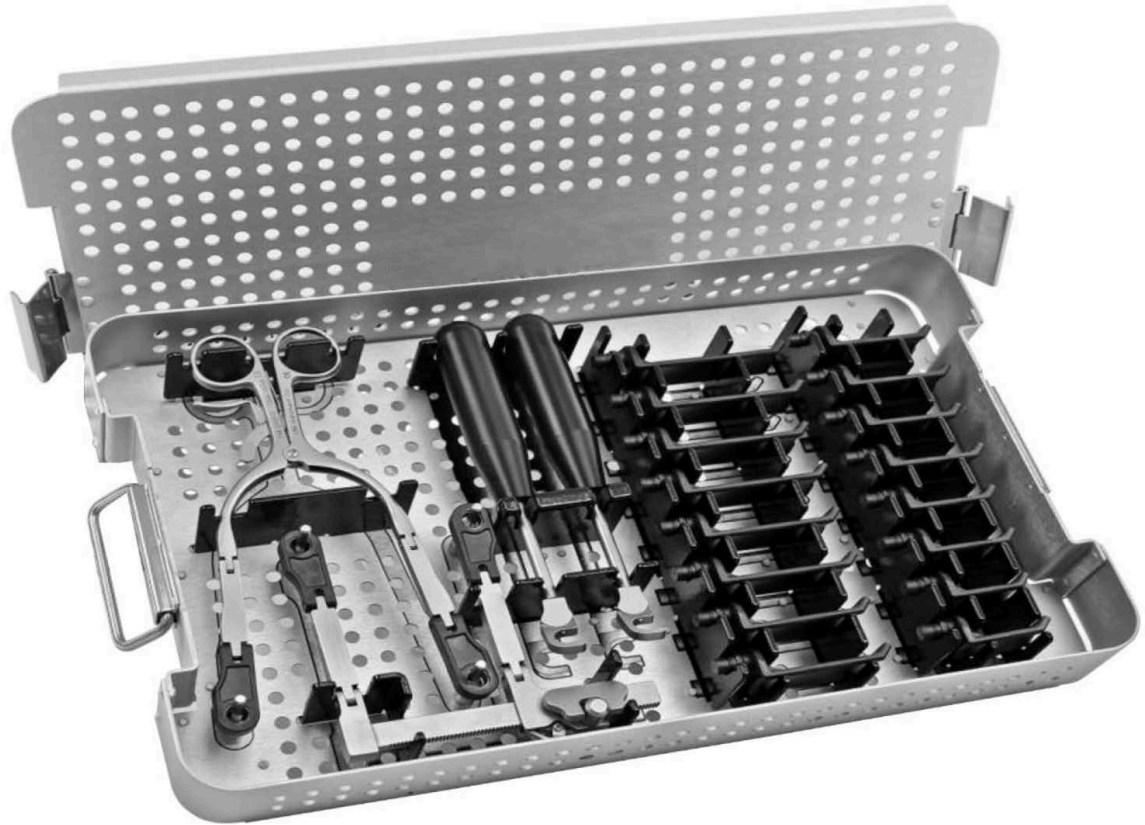

SMALL RADIOLOGENT CERVICAL RETRACTOR SYSTEM

Holds 16 Blades (Mix and Match)

TWS 80-1600/00



**TRANSVERSE RETRACTOR
FRAME WITH PEEK CONNECTOR**

TWS 80-1601/00



**LONGITUDINAL RETRACTOR
FRAME WITH PEEK CONNECTOR**

TWS 80-1602/00



TW Surgical

ANTERIOR CERVICAL RETRACTOR SYSTEM

** Titanium Blades **

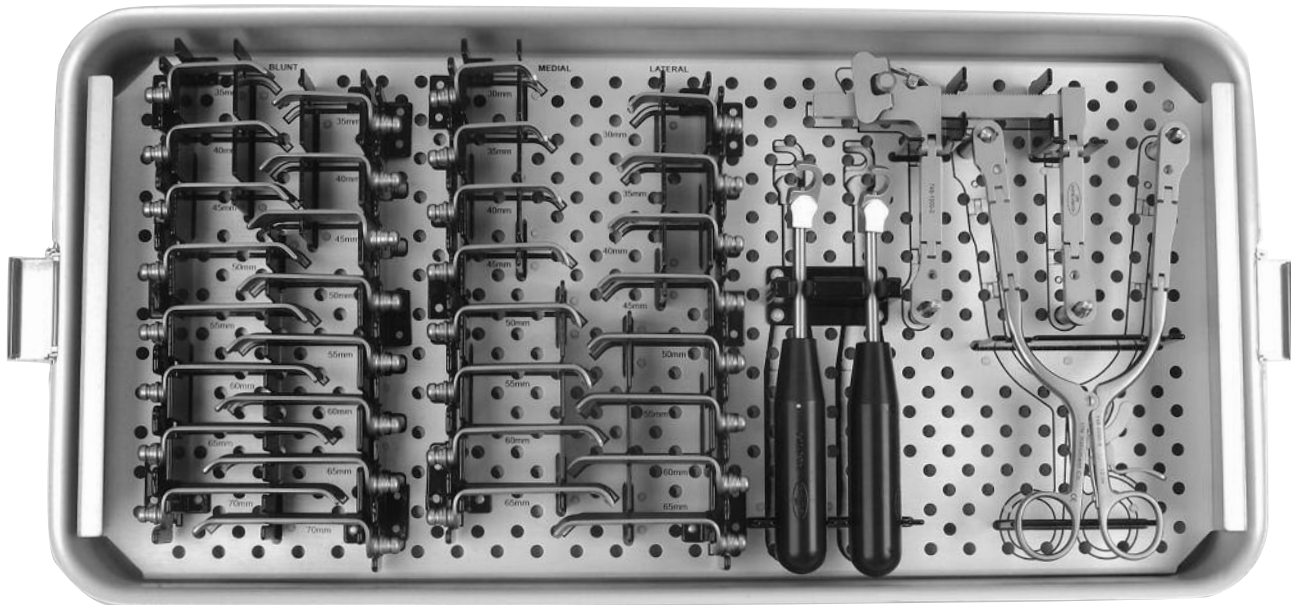

RETRACTOR SYSTEM

TWS 80-8000/00

Catalog #	Quantity	Description
TWS 80-8000/10	1	Transverse Retractor Frame Double Hinged Arms
TWS 80-8000/20	1	Longitudinal Counter Retractor Frame Double Hinged Arms
TWS 80-8000/30	1	Retractor Blade Medial 30x23 Toothed Titanium
TWS 80-8000/40	1	Retractor Blade Medial 35x23 Toothed Titanium
TWS 80-8000/50	1	Retractor Blade Medial 40x23 Toothed Titanium
TWS 80-8000/60	1	Retractor Blade Medial 45x23 Toothed Titanium
TWS 80-8000/70	1	Retractor Blade Medial 50x23 Toothed Titanium
TWS 80-8000/80	1	Retractor Blade Medial 55x23 Toothed Titanium
TWS 80-8000/90	1	Retractor Blade Medial 60x23 Toothed Titanium
TWS 80-8000/01	1	Retractor Blade Medial 65x23 Toothed Titanium
TWS 80-8000/11	2	Retractor Blade 35x23 Blunt Titanium
TWS 80-8000/21	2	Retractor Blade 40x23 Blunt Titanium
TWS 80-8000/31	2	Retractor Blade 45x23 Blunt Titanium
TWS 80-8000/41	2	Retractor Blade 50x23 Blunt Titanium
TWS 80-8000/51	2	Retractor Blade 55x23 Blunt Titanium
TWS 80-8000/61	2	Retractor Blade 60x23 Blunt Titanium
TWS 80-8000/71	2	Retractor Blade 65x23 Blunt Titanium
TWS 80-8000/81	2	Retractor Blade 70x23 Blunt Titanium
TWS 80-8000/91	1	Retractor Blade Lateral 30x23 Toothed Titanium
TWS 80-8000/02	1	Retractor Blade Lateral 35x23 Toothed Titanium
TWS 80-8000/12	1	Retractor Blade Lateral 40x23 Toothed Titanium
TWS 80-8000/32	1	Retractor Blade Lateral 45x23 Toothed Titanium
TWS 80-8000/42	1	Retractor Blade Lateral 50x23 Toothed Titanium
TWS 80-8000/52	1	Retractor Blade Lateral 55x23 Toothed Titanium
TWS 80-8000/62	1	Retractor Blade Lateral 60x23 Toothed Titanium
TWS 80-8000/72	1	Retractor Blade Lateral 65x23 Toothed Titanium
TWS 80-8000/82	2	Blade Holders
TWS 80-8000/92	1	Sterilization Tray: Includes Outer Tray and Lid, 1 Level Insert

CLOWARD CERVICAL RETRACTORS

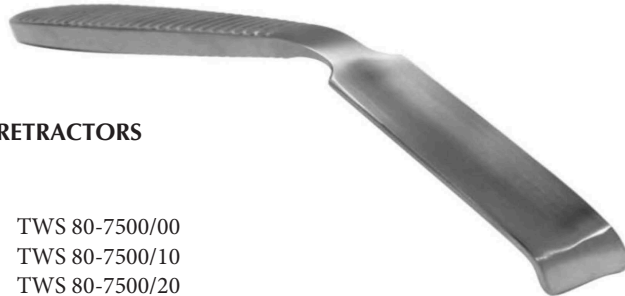

CLOWARD CERVICAL RETRACTORS

SIZE

13mm (no lip)	TWS 80-7500/00
18mm	TWS 80-7500/10
20mm	TWS 80-7500/20
23mm	TWS 80-7500/30
40mm	TWS 80-7500/40

MODIFIED CLOWARD CERVICAL RETRACTORS



MODIFIED CERVICAL RETRACTORS

18mm without lip	TWS 80-7501/00
20mm without lip	TWS 80-7501/10
23mm without lip	TWS 80-7501/20

CERVICAL RETRACTORS

CERVICAL RETRACTORS WITH DOUBLE FINGER HOLD 3" depth 75mm

Serrated	TWS 80-7502/00
Smooth	TWS 80-7502/10



CERVICAL DISTRACTORS



CASPAR STYLE DISTRACTORS

Right Distractor TWS 80-7503/00
 Left Distractor TWS 80-7503/10

HINGED DISTRACTOR



HINGED DISTRACTOR

TWS 80-7504/00

CERVICAL DISTRACTION SCREW RETRACTOR BLADE



CURVED CERVICAL DISTRACTION RETRACTOR BLADE

TWS 80-7505/00



Fits over Caspar Screw
Does not interfere with Distrac

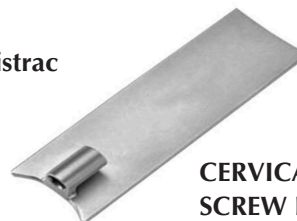

CERVICAL DISTRACTION SCREW RETRACTOR BLADE

TWS 80-7506/00

CERVICAL DISTRACTION SCREW



CERVICAL DISTRACTION SCREW

SIZE	SINGLE	PACK OF 10
12mm	TWS 80-7507/00	TWS 80-7507/01
14mm	TWS 80-7507/10	TWS 80-7507/11
16mm	TWS 80-7507/20	TWS 80-7507/21

DISTRACTION SCREWDRIVER



DISTRACTION SCREWDRIVER

TWS 80-7508/00

CALIPER

CALIPER

TWS 80-7509/00

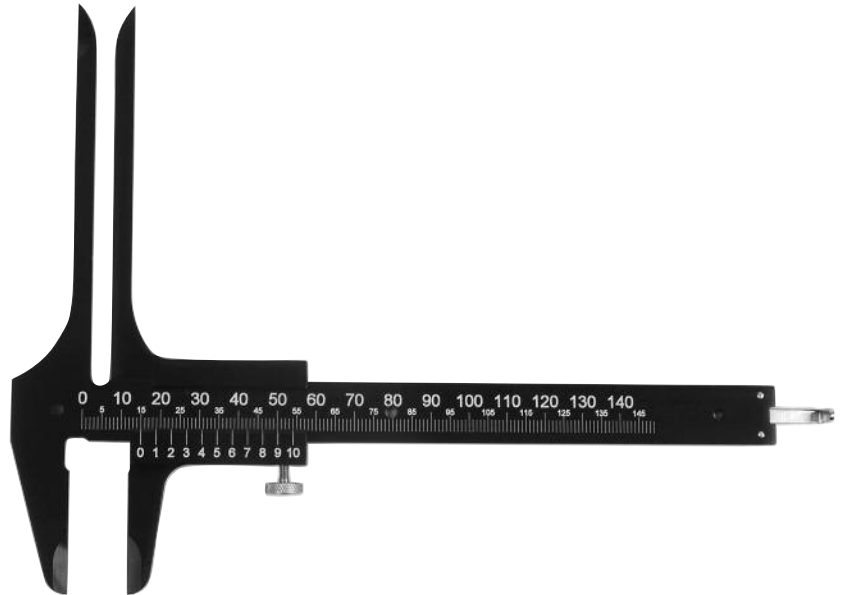

TWIST DRILL



TWIST DRILL

TWS 80-7510/00

DRILL GUIDE

DRILL GUIDE

Drill Guide Right	TWS 80-7511/00
Drill Guide Left	TWS 80-7511/10



CERVICAL RETRACTOR CASPAR STYLE

LONGITUDINAL RETRACTOR FRAME SINGLE HINGE

TWS 80-7512/00



TRANSVERSE RETRACTOR FRAME SINGLE HINGE

TWS 80-7513/00



RETRACTOR BLADES



MEDIAL

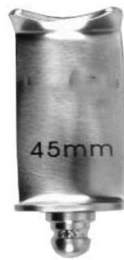

BLUNT



LATERAL

MEDIAL BLADES

40 x 23mm	TWS 80-4000/00
45 x 23mm	TWS 80-4000/10
50 x 23mm	TWS 80-4000/20
55 x 23mm	TWS 80-4000/30
60 x 23mm	TWS 80-4000/40

BLUNT BLADES

45 x 23mm	TWS 80-4001/00
50 x 23mm	TWS 80-4001/10
55 x 23mm	TWS 80-4001/20
60 x 23mm	TWS 80-4001/30
65 x 23mm	TWS 80-4001/40

LATERAL BLADES

40 x 23mm	TWS 80-4003/00
45 x 23mm	TWS 80-4003/10
50 x 23mm	TWS 80-4003/20
55 x 23mm	TWS 80-4003/30
60 x 23mm	TWS 80-4003/40

BLADE EJECTOR



BLADE EJECTOR

TWS 80-4002/00

McCULLOCH STYLE RETRACTOR

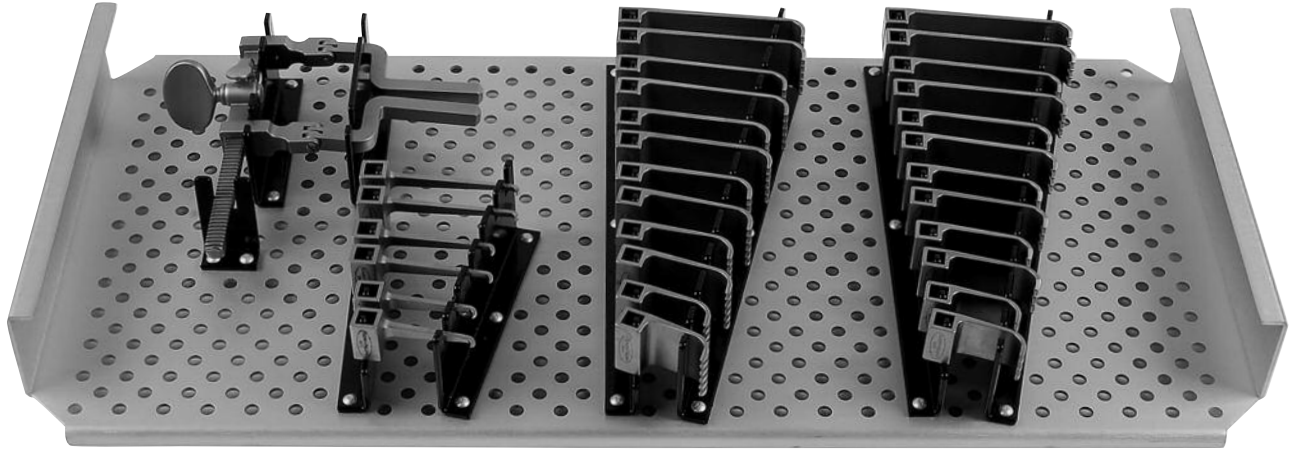

McCULLOCH RETRACTOR SYSTEM Matte Finish Stainless Steel

TWS 80-2350/00

Standard Set

Catalog #	Quantity	Description
TWS 80-2350/10	1	Hinged Retractor Frame
TWS 80-2350/20	2	Small Muscle Blades 20x30mm
TWS 80-2350/30	2	Small Muscle Blades 20x40mm
TWS 80-2350/40	2	Small Muscle Blades 20x50mm
TWS 80-2350/50	2	Small Muscle Blades 20x60mm
TWS 80-2350/60	2	Small Muscle Blades 20x70mm
TWS 80-2350/70	2	Small Muscle Blades 20x80mm
TWS 80-2350/80	2	Large Muscle Blades 27x30mm
TWS 80-2350/90	2	Large Muscle Blades 27x40mm
TWS 80-2350/01	2	Large Muscle Blades 27x50mm
TWS 80-2350/01	2	Large Muscle Blades 27x60mm
TWS 80-2350/21	2	Large Muscle Blades 27x70mm
TWS 80-2350/31	2	Large Muscle Blades 27x80mm
TWS 80-2350/41	1	Hook 30mm
TWS 80-2350/51	1	Hook 40mm
TWS 80-2350/61	1	Hook 50mm
TWS 80-2350/71	1	Hook 60mm
TWS 80-2350/81	1	Hook 70mm
TWS 80-2350/91	1	Hook 80mm
TWS 80-2350/02	1	Sterilization Case for Retractor System

Additional length components available.

COMPONENTS

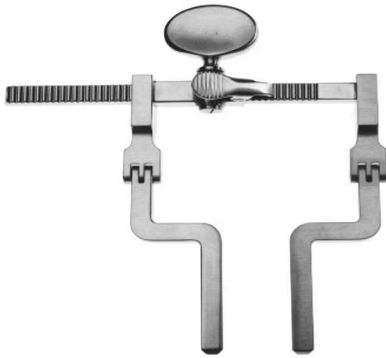

FRAME

TWS 80-2351/00



HOOK

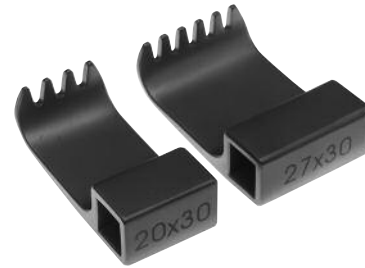

SMALL AND LARGE MUSCLE BLADES

ADDITIONAL ITEMS



**LONG SMALL
MUSCLE BLADE**



**LONG LARGE
MUSCLE BLADE**

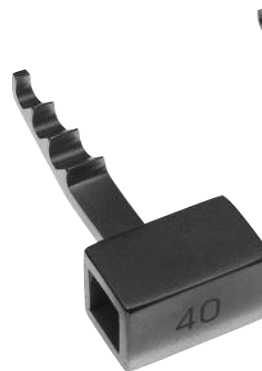

STEPPED HOOK



LONG HOOK

Catalog #	Quantity	Description
TWS 80-2351/10	1	Long Small Muscle Blade 20x90mm
TWS 80-2351/20	1	Long Small Muscle Blade 20x100mm
TWS 80-2351/30	1	Long Small Muscle Blade 20x110mm
TWS 80-2351/40	1	Long Small Muscle Blade 20x120mm
TWS 80-2351/50	1	Long Large Muscle Blade 24x90mm
TWS 80-2351/60	1	Long Large Muscle Blade 24x100mm
TWS 80-2351/70	1	Long Large Muscle Blade 24x110mm
TWS 80-2351/80	1	Long Large Muscle Blade 24x120mm

Catalog #	Quantity	Description
TWS 80-2351/90	1	Stepped Hook 30mm
TWS 80-2351/11	1	Stepped Hook 40mm
TWS 80-2351/21	1	Stepped Hook 50mm
TWS 80-2351/31	1	Stepped Hook 60mm
TWS 80-2351/41	1	Stepped Hook 70mm
TWS 80-2351/51	1	Stepped Hook 80mm
TWS 80-2351/61	1	Stepped Hook 90mm
TWS 80-2351/71	1	Stepped Hook 100mm
TWS 80-2351/81	1	Stepped Hook 110mm
TWS 80-2351/91	1	Extra Long Hook 90mm
TWS 80-2351/12	1	Extra Long Hook 100mm
TWS 80-2351/22	1	Extra Long Hook 110mm

RADIOLUCENT RETRACTORS

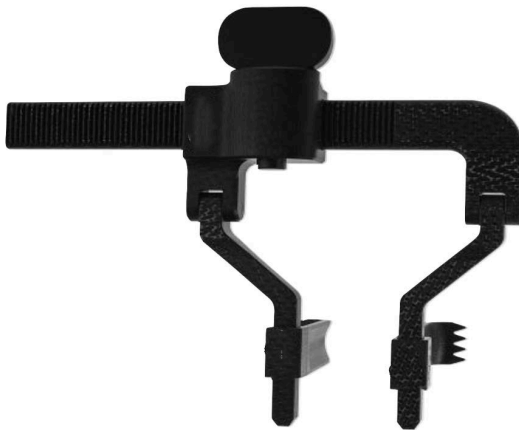

PINION

Included with Frame

TWS 80-6400/00

RADIOLUCENT CARBON FIBER PEEK RETRACTOR FRAME

TWS 80-6401/00

CARBON FIBER PEEK BLADES



SIZE	20mm width	25mm width
50mm	TWS 80-2003/00	TWS 80-2003/01
70mm	TWS 80-2003/10	TWS 80-2003/11
90mm	TWS 80-2003/20	TWS 80-2003/21
110mm	TWS 80-2003/30	TWS 80-2003/31

Additional blade sizes available upon request. Please visit our website at www.lifeinstruments.com.

MICRO LUMBAR DISCECTOMY RETRACTOR



RETRACTOR FRAME

TWS 80-2004/00

SPECULAS

40mm	TWS 80-4001/00
45mm	TWS 80-4001/10
50mm	TWS 80-4001/20
55mm	TWS 80-4001/30
60mm	TWS 80-4001/40
65mm	TWS 80-4001/50
75mm	TWS 80-4001/60



BLADES

35mm	TWS 80-3502/00
40mm	TWS 80-3502/10
45mm	TWS 80-3502/20
50mm	TWS 80-3502/30
55mm	TWS 80-3502/40
60mm	TWS 80-3502/50
65mm	TWS 80-3502/60
70mm	TWS 80-3502/70
75mm	TWS 80-3502/80



OFFSET LAMINA SPREADERS

OFFSET LAMINA SPREADER

TWS 80-3503/00



OFFSET LAMINA SPREADER WITH LOCKING SPINDLE

TWS 80-3504/00



LAMINA SPREADERS

LAMINA SPREADER WITH LOCKING SPINDLE

3" Deep TWS 80-3505/00
5" Deep TWS 80-3506/00



LAMINA SPREADERS

LAMINA SPREADERS

Small 6.5"	TWS 80-6500/00
Small 6.5"	TWS 80-6500/10 with Spindle
Large 10"	TWS 80-6500/20



SMALL



LARGE

LONG TAPERED SPREADER

LONG TAPERED SPREADER

TWS 80-6501/00
TWS 80-6501/10 Spreader without taper



MULTI ACTION RETRACTORS



PLAN B MULTI ACTION RETRACTOR WITH LOCKING SPINDLE

50mm	TWS 80-7550/00
75mm	TWS 80-7550/10
100mm	TWS 80-7550/20
75mm	TWS 80-7550/30 with Light



4 BLADE RETRACTOR WITH LOCKING SPINDLE

70mm	TWS 80-7551/00
------	----------------

LOVE NERVE ROOT RETRACTORS

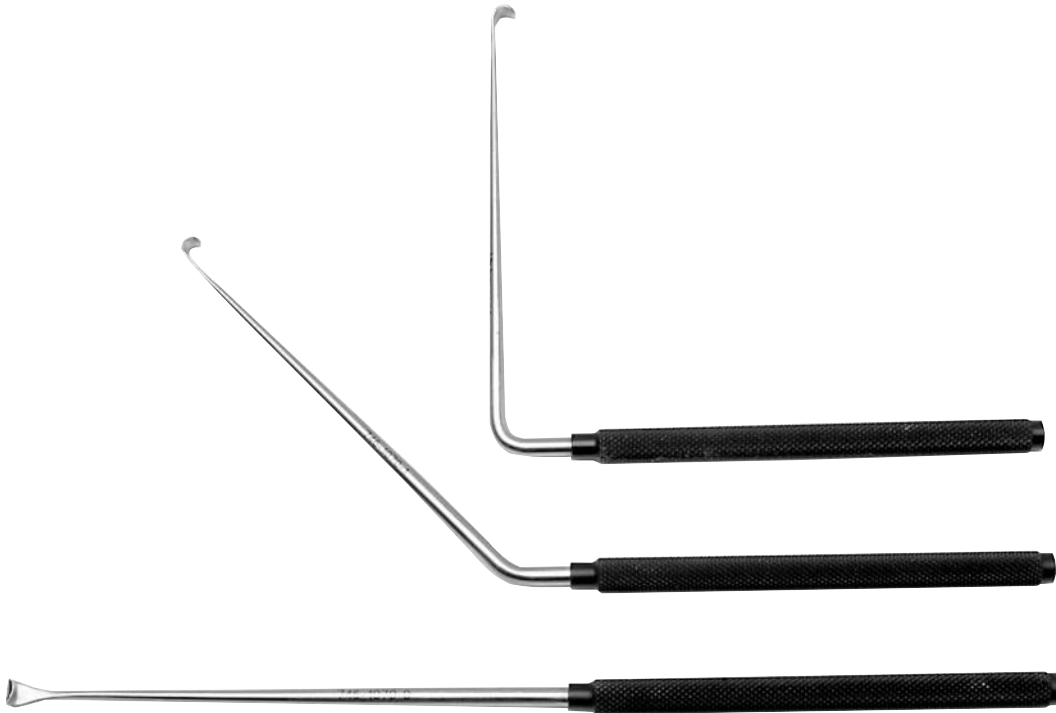

LOVE NERVE ROOT RETRACTORS

Straight	TWS 80-4501/00	
45°	TWS 80-4501/10	5" from bend
90°	TWS 80-4501/20	

WIDE SCOVILLE NERVE ROOT RETRACTORS

WIDE SCOVILLE NERVE ROOT RETRACTORS 7" from bend 45°

10mm	TWS 80-4502/00
12mm	TWS 80-4502/10
14mm	TWS 80-4502/20



SCOVILLE NERVE ROOT RETRACTORS

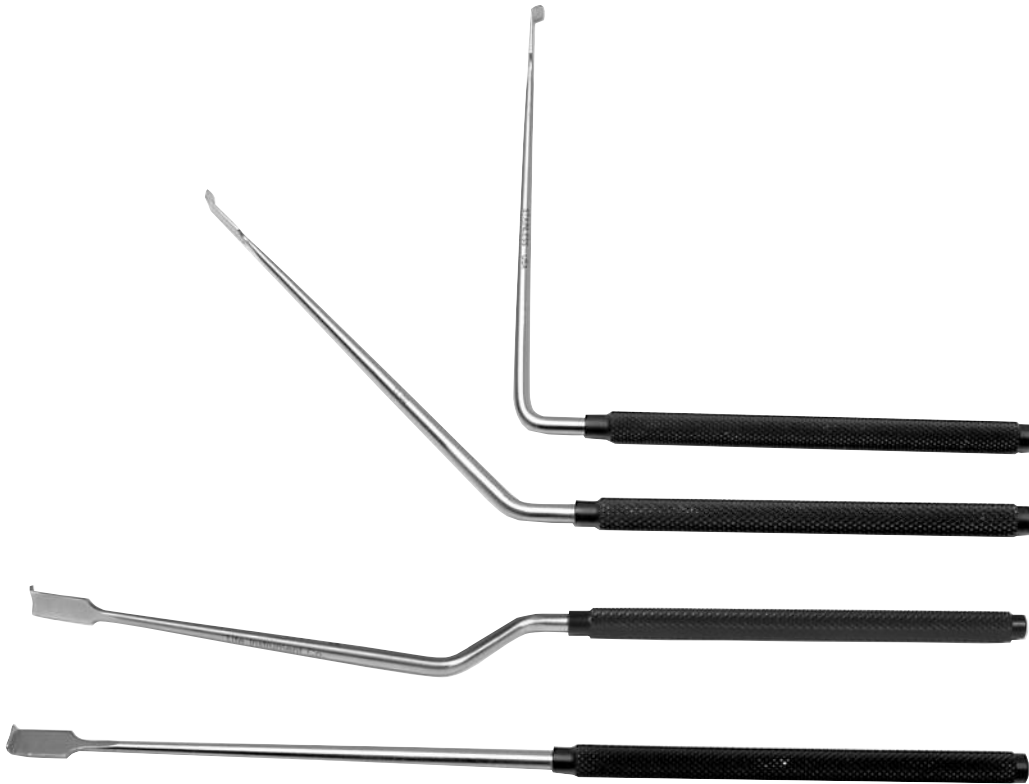

SCOVILLE NERVE ROOT RETRACTORS

8mm

Straight	TWS 80-8001/00
45°	TWS 80-8001/10 5" from bend
90°	(125mm) TWS 80-8001/20
Bayonet	TWS 80-8001/30

HESS NERVE RETRACTORS

3mm

45°	TWS 80-3005/00
90°	TWS 80-3005/10
Bayonet	TWS 80-3005/20



5mm

45°	TWS 80-5001/00
90°	TWS 80-5001/10
Bayonet	TWS 80-5001/20

All nerve root retractors have black knurled handles for better feel and control.

Custom handles available upon request.

No lip available upon request.

EXTRA LONG NERVE ROOT RETRACTORS

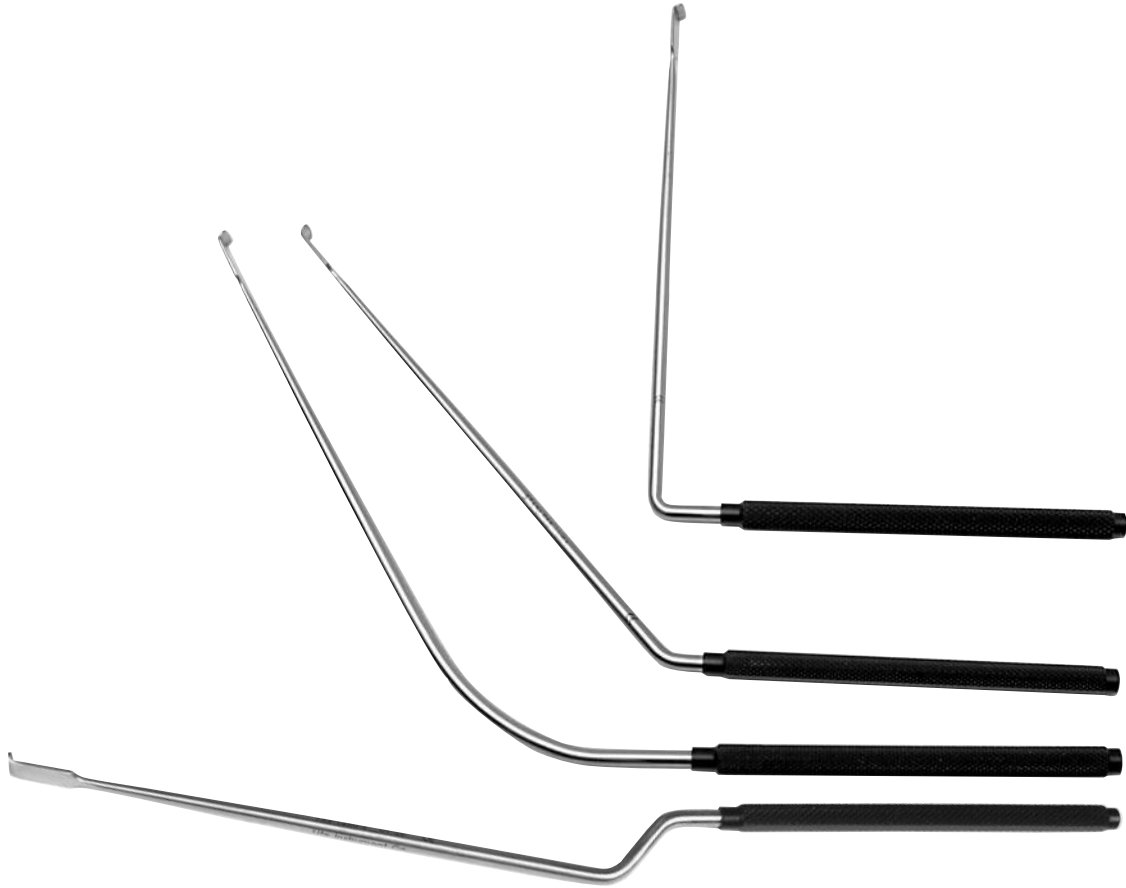

SCOVILLE RETRACTORS

8mm

90°	TWS 80-8001/00	7" from bend (175mm)
45°	TWS 80-8001/10	7" from bend (175mm)
Full Curve	TWS 80-8001/20	
Bayonet	TWS 80-8001/30	6" from bend (150mm)

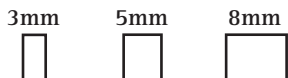

HESS NERVE RETRACTORS

3mm

90°	TWS 80-3005/00	7" from bend (175mm)
45°	TWS 80-3005/10	7" from bend (175mm)
Bayonet	TWS 80-3005/20	6" from bend (150mm)

5mm

90°	TWS 80-3005/30	7" from bend (175mm)
45°	TWS 80-3005/40	7" from bend (175mm)
Bayonet	TWS 80-3005/50	6" from bend (150mm)

MEMORY METAL INSTRUMENTS



NERVE ROOT RETRACTORS

BAYONET

8mm	4.5" working length	TWS 80-4501/00
8mm	6" working length	TWS 80-4501/20
5mm	6" working length	TWS 80-4501/30

45°

5mm	7" working length	TWS 80-4501/40
8mm	7" working length	TWS 80-4501/50

90°

5mm	7" working length	TWS 80-4501/60
8mm	7" working length	TWS 80-4501/70

*

V-STYLE NERVE RETRACTOR



V-STYLE NERVE RETRACTOR

TWS 80-4502/00



TW Surgical

NERVE ROOT RETRACTORS



TWS 80-4502/00

TWS 80-4503/00

TWS 80-4504/00

NERVE ROOT RETRACTORS

Regular 8.5"	215mm	TWS 80-2150/00
Fine 8.5"	215mm	TWS 80-2150/10
Fine 10.5"	265mm	TWS 80-2150/20
Regular 10.5"	265mm	TWS 80-2150/30
Anterior 16.5"	420mm	TWS 80-2150/40

113cm

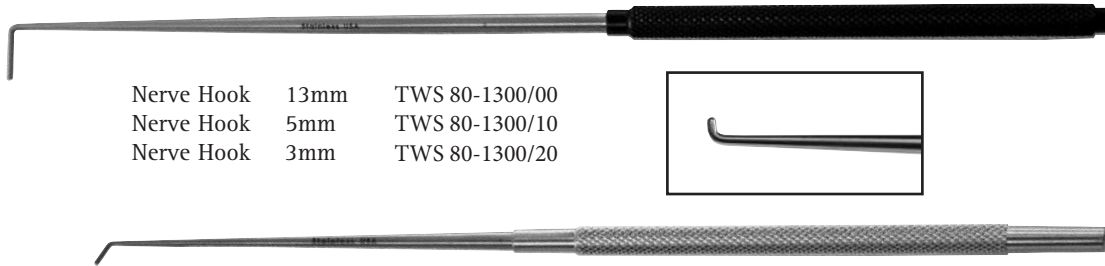

Nerve Hook	13mm	TWS 80-1300/00
Nerve Hook	5mm	TWS 80-1300/10
Nerve Hook	3mm	TWS 80-1300/20

Fine Nerve Hook 6mm TWS 80-6002/00

BAYONET NERVE HOOK



BAYONET NERVE HOOK
6" working length 150mm

TWS 80-1500/00	Down (shown above)
TWS 80-1500/10	Right
TWS 80-1500/20	Left
TWS 80-1500/30	Up

MICRO BAYONET NERVE HOOK



MICRO BAYONET NERVE HOOK
TWS 80-1501/00

MURPHY PROBES



MURPHY PROBES

2.7mm ball size

Murphy Ball Hook 8.5" 215mm
 Murphy Ball Hook w/Suture Hole
 8.5" Straight Ball Probe 215mm
 Murphy Ball Hook Long 10.5" 265mm
 Long Straight Ball Probe 10.5" 265mm

TWS 80-2701/00
 TWS 80-2701/10 (not shown)
 TWS 80-2701/20
 TWS 80-2701/30
 TWS 80-2701/40

BALL PROBES



BALL PROBES

9" length 230mm

Ball Probe #1	Straight	TWS 80-2300/00
Ball Probe #2	8mm 65° Bend	TWS 80-2300/10
Ball Probe #3	10mm 80° Bend	TWS 80-2300/20
Ball Probe #4	12mm 75° Bend	TWS 80-2300/30
Ball Probe #5	13mm 80° Bend	TWS 80-2300/40
Set of 5		TWS 80-2300/50

BAYONET BALL PROBES

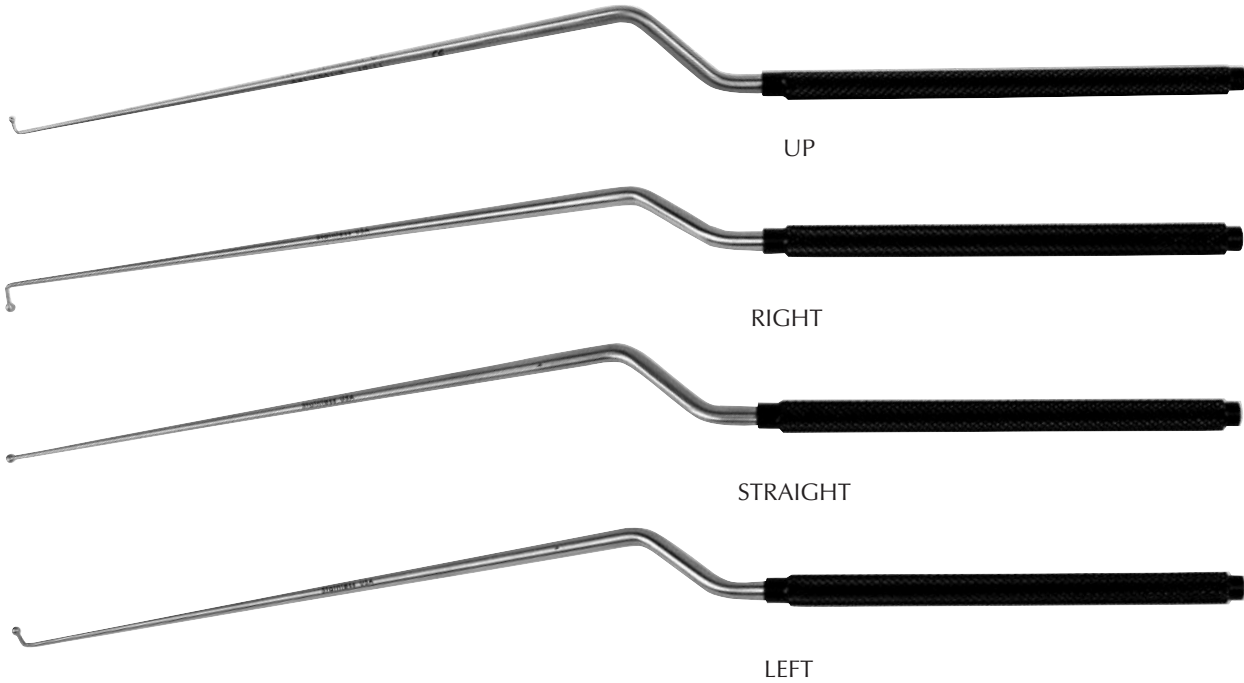

BAYONET BALL PROBES

6" working lengthh

Ball Probe Straight	TWS 80-6002/00
Ball Probe 5mm Up	TWS 80-6002/10
Ball Probe 5mm Right Ball	TWS 80-6002/30
Probe 5mm Left	TWS 80-6002/40
Ball Probe 9mm Up	TWS 80-6002/50
Ball Probe 9mm Right Ball	TWS 80-6002/60
Probe 9mm Left	TWS 80-6002/70

FLEXIBLE BALL PROBES

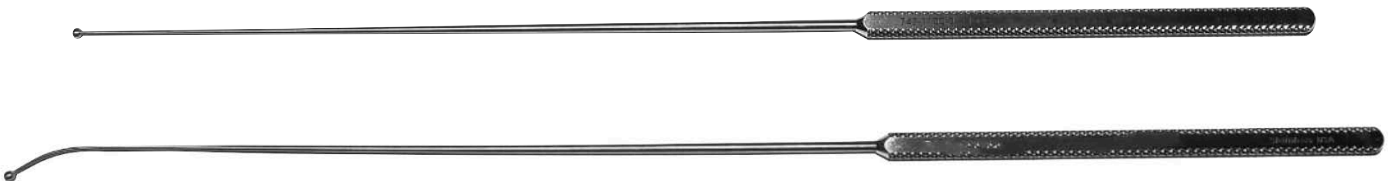

FLEXIBLE BALL PROBES

10.5" overall lengthh

Ball Probe Straight	TWS 80-1050/00
Ball Probe Curved	TWS 80-1050/10

MICRO BALL PROBES

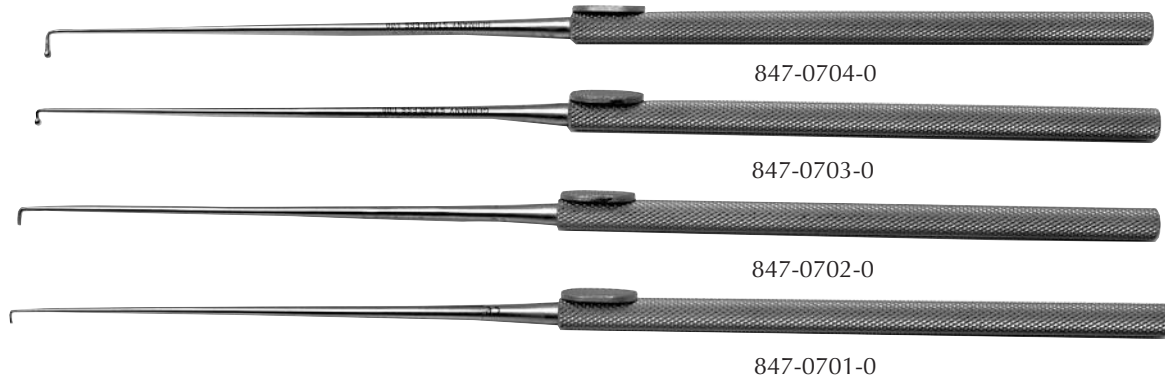

847-0704-0

847-0703-0

847-0702-0

847-0701-0

MICRO BALL PROBES AND HOOKS 7" length 175mm

Nerve Hook 2mm	TWS 80-1750/00
Nerve Hook 3mm	TWS 80-1750/10
3mm Ball Probe	TWS 80-1750/20
4mm Ball Probe	TWS 80-1750/30

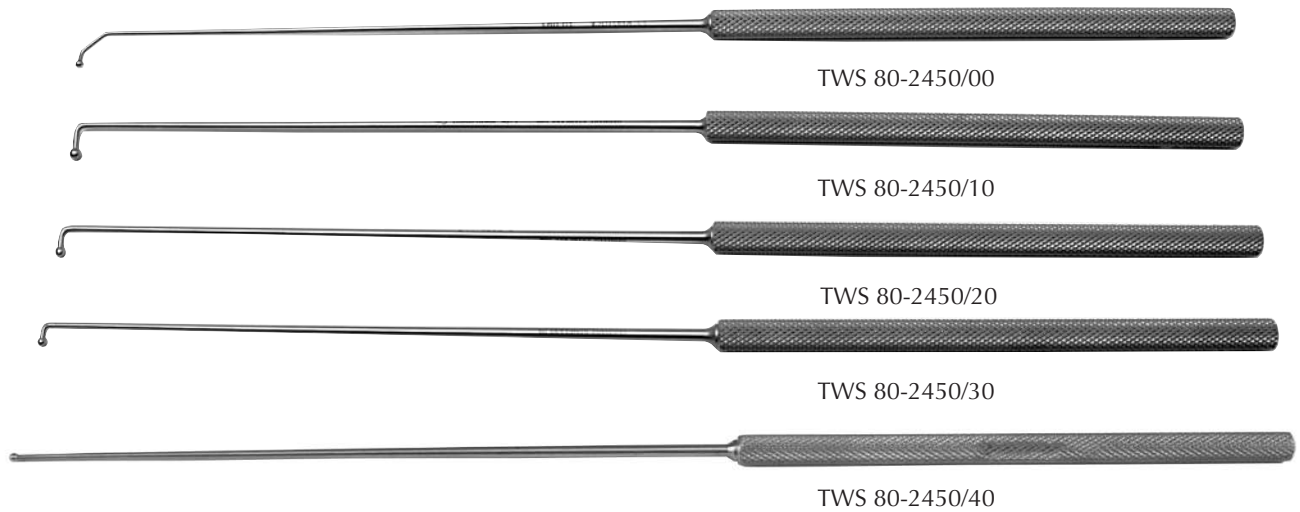

TWS 80-2450/00

TWS 80-2450/10

TWS 80-2450/20

TWS 80-2450/30

TWS 80-2450/40

MICRO BALL PROBES 9.5" overall length 245mm

5mm Ball Probe	TWS 80-2451/00
7mm Ball Probe	TWS 80-2451/10
9mm Ball Probe	TWS 80-2451/20
Curved Ball Probe	TWS 80-2451/30
Straight Ball Probe	TWS 80-2451/40



MICRO NERVE HOOK 9.5" overall length 245mm

TWS 80-2452/00 5mm

CARBON FIBER RETRACTORS

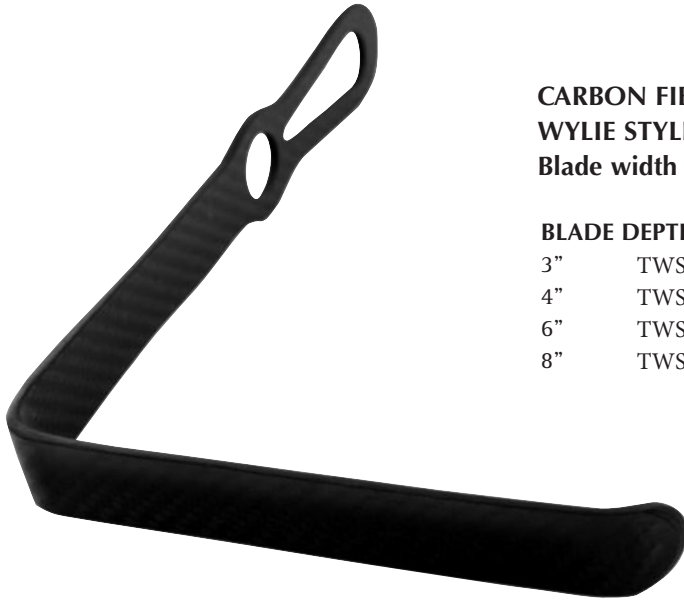

**CARBON FIBER ANTERIOR RETRACTORS
WYLIE STYLE**
Blade width 25mm

BLADE DEPTH

3"	TWS 80-2503/00
4"	TWS 80-2503/10
6"	TWS 80-2503/20
8"	TWS 80-2503/30



HOHMANN STYLE RETRACTOR
9.5" overall length

10mm	TWS 80-9500/00
18mm	TWS 80-9500/10
25mm	TWS 80-9500/20



CLOWARD RETRACTOR
100mm blade

TWS 80-1000/00

SUCTION SCOVILLE RETRACTOR



**SUCTION SCOVILLE RETRACTOR 7mm
7cm**

TWS 80-7003/00



SCOVILLE RETRACTOR WITH SUCTION TIP



**SCOVILLE RETRACTOR WITH SUCTION TIP
5" from bend**

5mm TWS 80-5002/00 8 FR
8mm TWS 80-5002/10 8 FR



FIBEROPTIC NERVE RETRACTOR

**FIBEROPTIC NERVE RETRACTOR
TWS 80-5003/00**



THIN FOOTPLATE KERRISON RONGEURS

THIN FOOTPLATE KERRISON RONGEURS 8" length 200mm

SIZE	40° FWD	90° UP
1mm	TWS 99-2000/00	TWS 99-2000/01
1.5mm	TWS 99-2000/10	TWS 99-2000/11
2mm	TWS 99-2000/20	TWS 99-2000/21
3mm	TWS 99-2000/30	TWS 99-2000/31
4mm	TWS 99-2000/40	TWS 99-2000/41
5mm	TWS 99-2000/50	TWS 99-2000/51



7" length 175mm

SIZE	40° FWD
1mm	TWS 99-1750/00
2mm	TWS 99-1750/10
3mm	TWS 99-1750/20
4mm	TWS 99-1750/30
5mm	TWS 99-1750/40



THIN FOOTPLATE KERRISON RONGEURS 8" length 200mm 15mm Wide Opening

SIZE	
1mm	TWS 99-1500/00
2mm	TWS 99-1500/10
3mm	TWS 99-1500/20
4mm	TWS 99-1500/30
5mm	TWS 99-1500/40

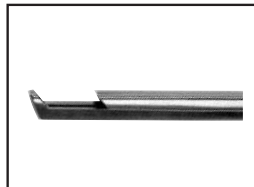

THIN FOOTPLATE KERRISON RONGEURS

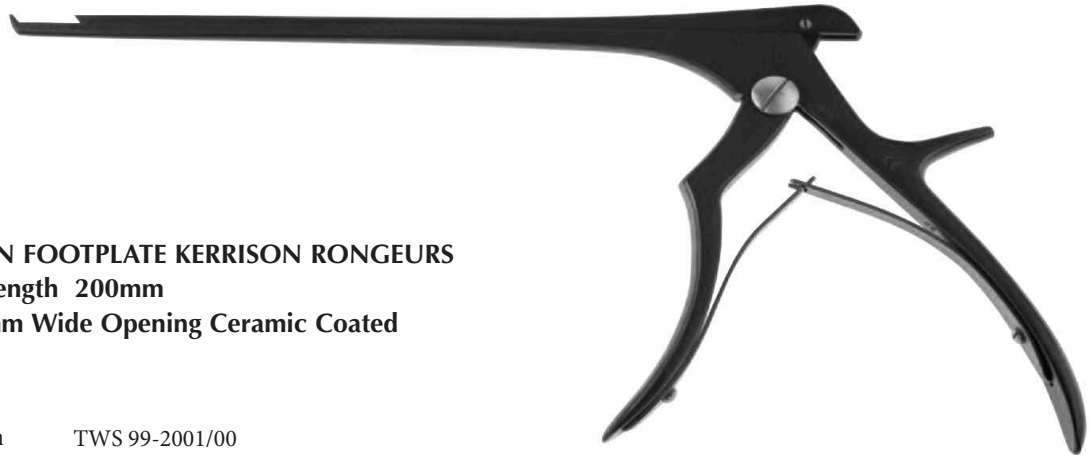

THIN FOOTPLATE KERRISON RONGEURS
8" length 200mm
15mm Wide Opening Ceramic Coated

SIZE

2mm	TWS 99-2001/00
3mm	TWS 99-2001/10
4mm	TWS 99-2001/20
5mm	TWS 99-2001/30

ULTRA THIN FOOTPLATE KERRISON RONGEURS



ULTRA THIN FOOTPLATE KERRISON RONGEURS
7" length 175mm

SIZE

1mm	TWS 99-1750/00
2mm	TWS 99-1750/10
3mm	TWS 99-1750/20

For Delicate Use Only

CERAMIC BONE EJECTING KERRISON RONGEURS



**CERAMIC BONE EJECTING KERRISON RONGEURS
THIN FOOTPLATE
8" length 40° FWD 200mm**

SIZE

2mm	TWS 99-2002/00
3mm	TWS 99-2002/10
4mm	TWS 99-2002/20
5mm	TWS 99-2002/30
6mm	TWS 99-2002/40

**CERAMIC KERRISON RONGEUR
THIN FOOTPLATE
8" length 200mm**

SIZE

1mm	TWS 99-2003/00
1.5mm	TWS 99-2003/10



**CERAMIC BONE EJECTING KERRISON RONGEURS
THIN FOOTPLATE
10" length 40° FWD 250mm**

SIZE

2mm	TWS 99-2500/00
3mm	TWS 99-2500/10
4mm	TWS 99-2500/20
5mm	TWS 99-2500/30

OPEN UP KERRISON RONGEURS



**8" OPEN UP KERRISONS
THIN FOOTPLATE
8" overall length 200mm**

SIZE

1mm	TWS 99-2004/00
2mm	TWS 99-2004/10
3mm	TWS 99-2004/20
4mm	TWS 99-2004/30
5mm	TWS 99-2004/40

Easy to Disassemble • Great for Cleaning



8" OPEN UP KERRISON STERILIZATION TRAY WITH COVER

Holds 5 Open Up Kerrisons
Outer Dimensions: 10" x 21.5" x 1.5"

TWS 99-2150/00

OPEN UP KERRISON RONGEURS



10" & 12" OPEN UP KERRISONS

10" overall length 250mm

THIN FOOTPLATE

SIZE	40° FWD
1mm	TWS 99-2501/00
2mm	TWS 99-2501/10
3mm	TWS 99-2501/20
4mm	TWS 99-2501/30
5mm	TWS 99-2501/40

12" overall length 300mm

SIZE	40° FWD
2mm	TWS 99-3000/00
3mm	TWS 99-3000/10
4mm	TWS 99-3000/20



OPEN UP KERRISON STERILIZATION TRAY WITH COVER

Holds 5 each 10" Open Up Kerrisons

Or 3 each 12" Open Up Kerrisons

Outer Dimensions: 10" x 21.5" x 2"

TWS 99-2151/00

Treasure Wright (U.K.) Ltd.
128 City Road, London, EC1V 2NX, UK
info@twrightmedical.com

CERAMIC OPEN UP KERRISON RONGEURS



**CERAMIC OPEN UP KERRISON RONGEURS
THIN FOOTPLATE
8" length 200mm 40° FWD**

SIZE

1mm	TWS 99-2005/00
2mm	TWS 99-2005/10
3mm	TWS 99-2005/20
4mm	TWS 99-2005/30
5mm	TWS 99-2005/40

CERAMIC BAYONET OPEN UP KERRISONS



**CERAMIC BAYONET OPEN UP KERRISONS
THIN FOOTPLATE
6.75" working length 170mm 40° FWD**

SIZE

1mm	TWS 99-1700/00
2mm	TWS 99-1700/10
3mm	TWS 99-1700/20
4mm	TWS 99-1700/30

CERAMIC EJECTOR KERRISON RONGEURS

**CERAMIC KERRISON RONGEURS
WITH SIDE SLIDING EJECTOR**
8" length 40° FWD 200mm

SIZE

1mm	TWS 99-2006/00
2mm	TWS 99-2006/10
3mm	TWS 99-2006/20
4mm	TWS 99-2006/30
5mm	TWS 99-2006/40



EJECTOR KERRISON RONGEURS

**KERRISON RONGEURS
WITH SIDE SLIDING EJECTOR**
8" length 40° FWD 200mm

SIZE

1mm	TWS 99-2007/00
2mm	TWS 99-2007/10
3mm	TWS 99-2007/20
4mm	TWS 99-2007/30
5mm	TWS 99-2007/40

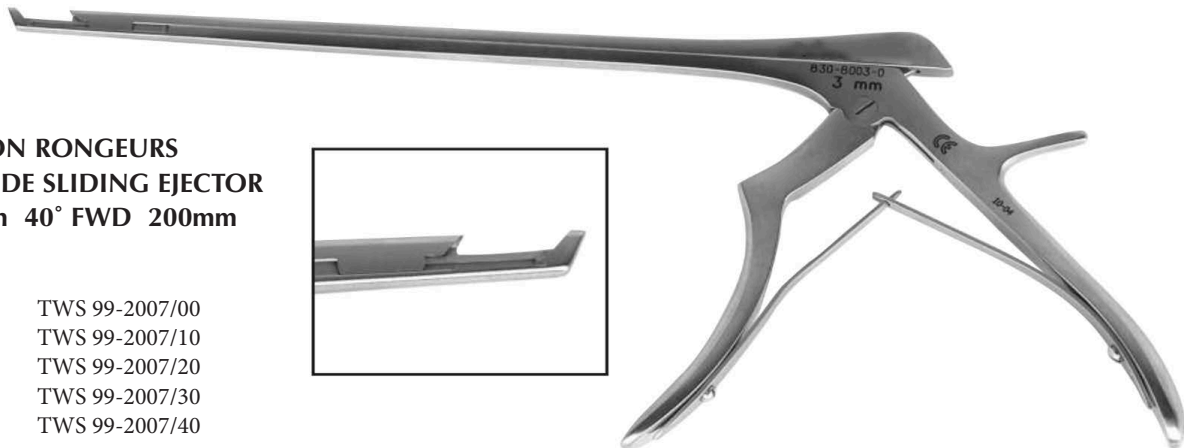

SCREWDRIVERS



SCREWDRIVERS 9.5" length

.215 x .020 Blade	.120 x .020 Blade
TWS 99-2152/00	TWS 99-1200/00

KERRISON RONGEURS



Standard Footplate

KERRISON RONGEURS 8" length 200mm

SIZE	40° FWD	90° UP	90° DWN
1mm	TWS 99-2008/00	TWS 99-2008/01	TWS 99-2008/02
2mm	TWS 99-2008/10	TWS 99-2008/11	TWS 99-2008/12
3mm	TWS 99-2008/20	TWS 99-2008/21	TWS 99-2008/22
4mm	TWS 99-2008/30	TWS 99-2008/31	TWS 99-2008/32
5mm	TWS 99-2008/40	TWS 99-2008/41	TWS 99-2008/42
6mm	TWS 99-2008/50	TWS 99-2008/51	TWS 99-2008/52



TRAY

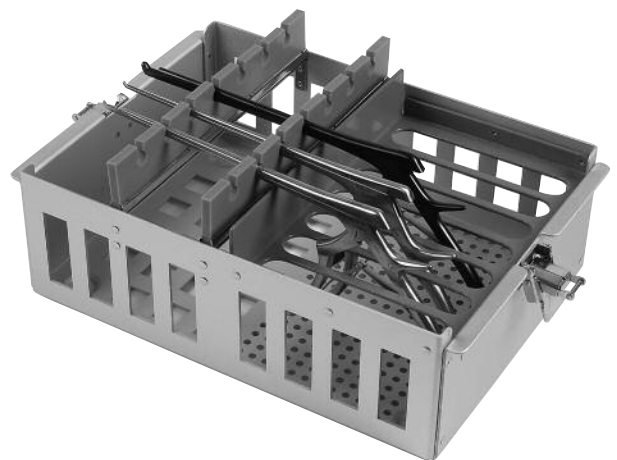
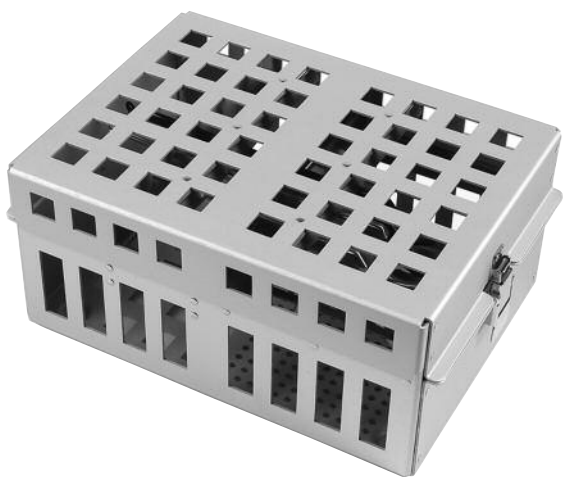

KERRISON INSTRUMENT TRAY

Holds 7 Kerrisons

TWS 99-2009/00

ANTERIOR KERRISON RONGEURS

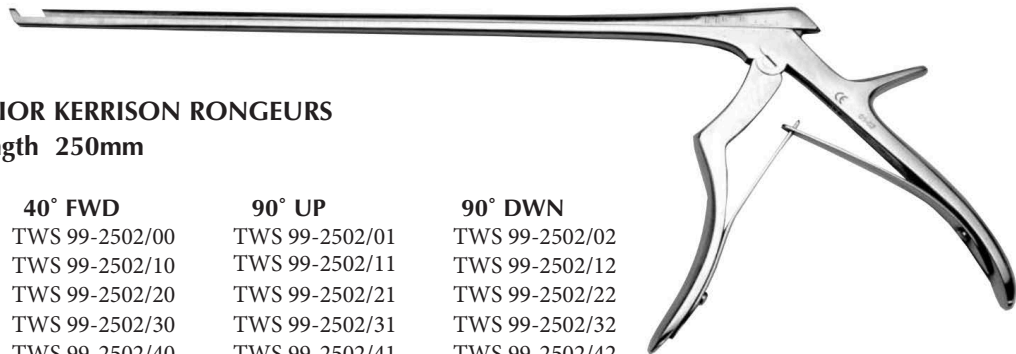

ANTERIOR KERRISON RONGEURS 10" length 250mm

SIZE	40° FWD	90° UP	90° DWN
1mm	TWS 99-2502/00	TWS 99-2502/01	TWS 99-2502/02
2mm	TWS 99-2502/10	TWS 99-2502/11	TWS 99-2502/12
3mm	TWS 99-2502/20	TWS 99-2502/21	TWS 99-2502/22
4mm	TWS 99-2502/30	TWS 99-2502/31	TWS 99-2502/32
5mm	TWS 99-2502/40	TWS 99-2502/41	TWS 99-2502/42
6mm	TWS 99-2502/50	TWS 99-2502/51	TWS 99-2502/52

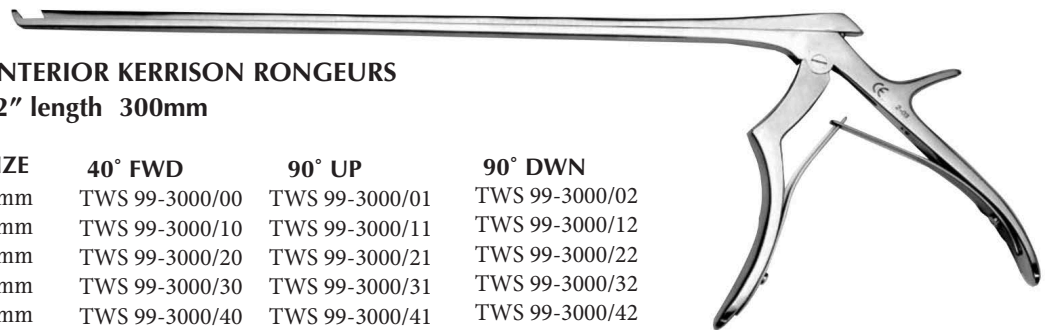

ANTERIOR KERRISON RONGEURS 12" length 300mm

SIZE	40° FWD	90° UP	90° DWN
2mm	TWS 99-3000/00	TWS 99-3000/01	TWS 99-3000/02
3mm	TWS 99-3000/10	TWS 99-3000/11	TWS 99-3000/12
4mm	TWS 99-3000/20	TWS 99-3000/21	TWS 99-3000/22
5mm	TWS 99-3000/30	TWS 99-3000/31	TWS 99-3000/32
6mm	TWS 99-3000/40	TWS 99-3000/41	TWS 99-3000/42

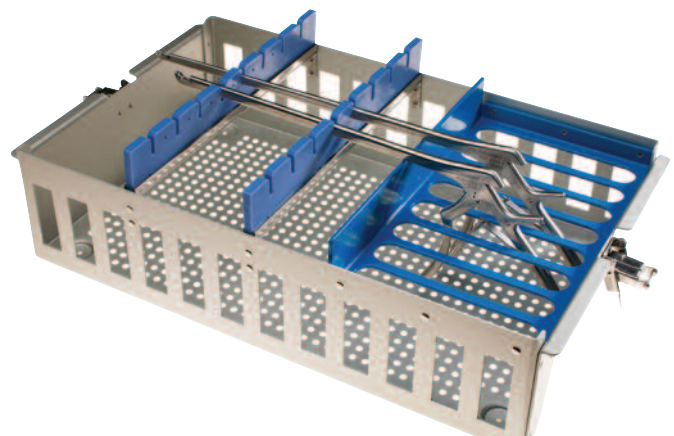
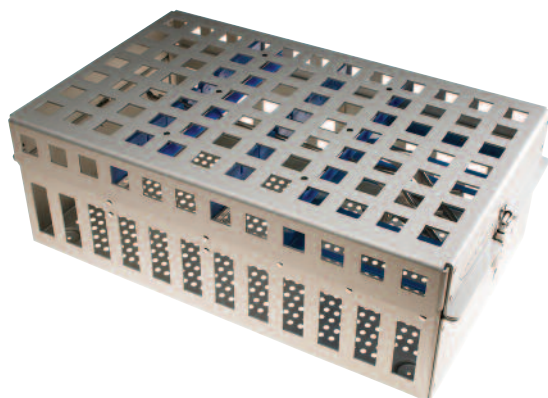

ANTERIOR KERRISON INSTRUMENT TRAY

Holds 7 each 10" or 12" Anterior Kerrisons

TWS 99-2009/00

FORAMINOTOMY RONGEURS

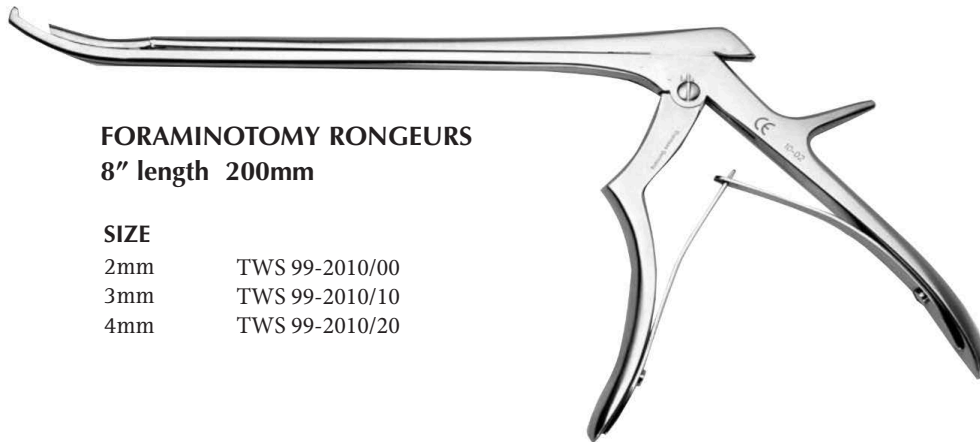

FORAMINOTOMY RONGEURS
8" length 200mm

SIZE

2mm	TWS 99-2010/00
3mm	TWS 99-2010/10
4mm	TWS 99-2010/20

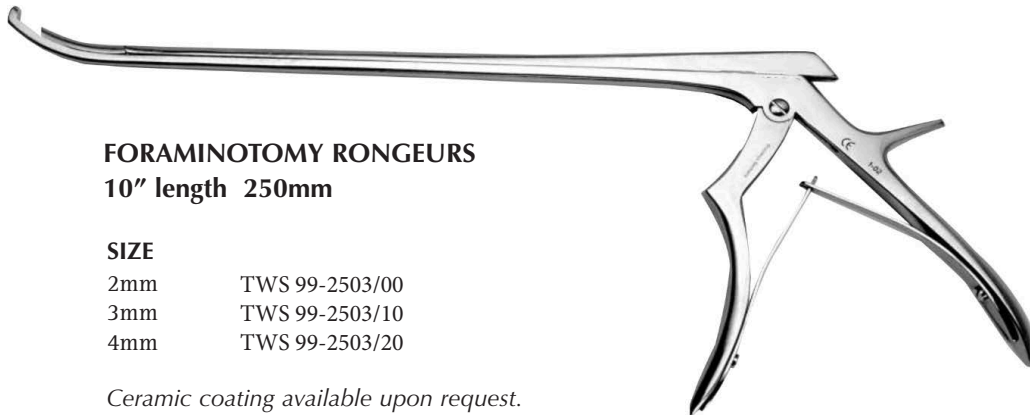

FORAMINOTOMY RONGEURS
10" length 250mm

SIZE

2mm	TWS 99-2503/00
3mm	TWS 99-2503/10
4mm	TWS 99-2503/20

Ceramic coating available upon request.

ANTERIOR KERRISON RONGEURS

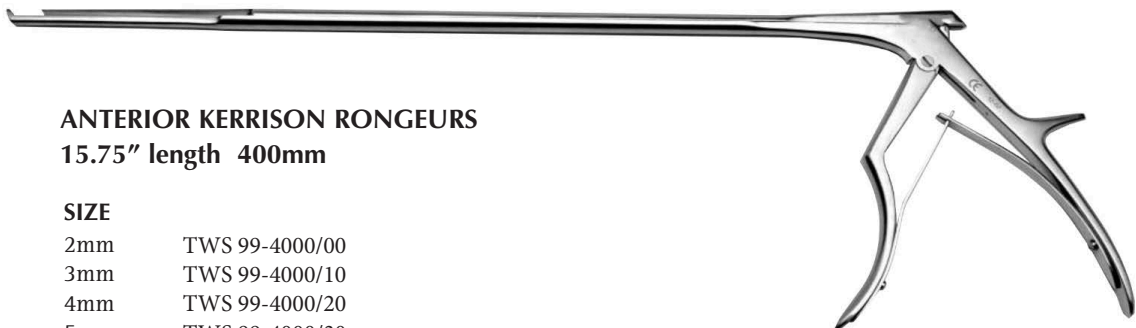

ANTERIOR KERRISON RONGEURS
15.75" length 400mm

SIZE

2mm	TWS 99-4000/00
3mm	TWS 99-4000/10
4mm	TWS 99-4000/20
5mm	TWS 99-4000/30
6mm	TWS 99-4000/40
7mm	TWS 99-4000/50

SPURLING KERRISON RONGEURS

SPURLING KERRISON RONGEURS
8" length 200mm
15mm throat opening Large Handle

SIZE	40° FWD
1mm	TWS 99-2020/00
2mm	TWS 99-2020/10
3mm	TWS 99-2020/20
4mm	TWS 99-2020/30
5mm	TWS 99-2020/40



10" length 250mm

SIZE	40° FWD
2mm	TWS 99-2504/00
3mm	TWS 99-2504/10
4mm	TWS 99-2504/20
5mm	TWS 99-2504/30

GERARD RONGEURS

GERARD RONGEURS
8" length 40° Back Biting Rongeur 200mm

SIZE	
3mm	TWS 99-2030/00
5mm	TWS 99-2030/10



FERRIS SMITH PITUITARY RONGEURS

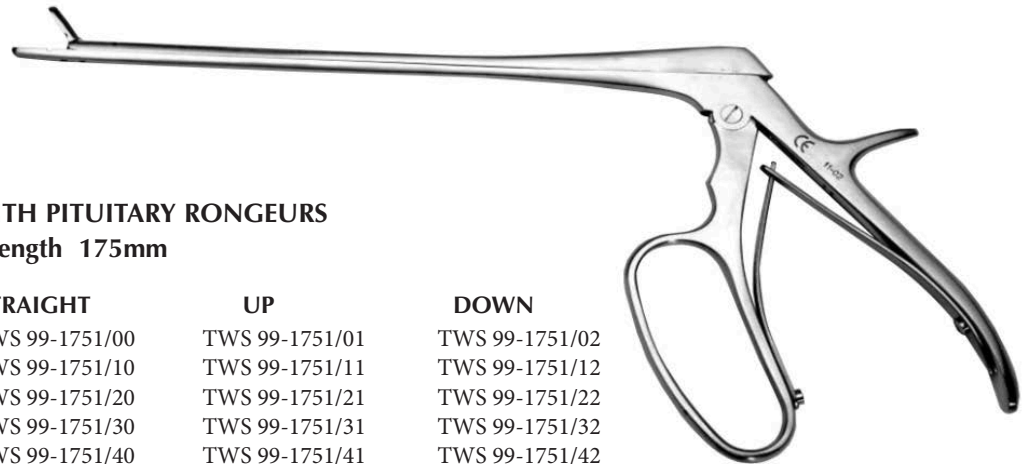

FERRIS SMITH PITUITARY RONGEURS 7" overall length 175mm

SIZE	STRAIGHT	UP	DOWN
2mm	TWS 99-1751/00	TWS 99-1751/01	TWS 99-1751/02
3mm	TWS 99-1751/10	TWS 99-1751/11	TWS 99-1751/12
4mm	TWS 99-1751/20	TWS 99-1751/21	TWS 99-1751/22
5mm	TWS 99-1751/30	TWS 99-1751/31	TWS 99-1751/32
6mm	TWS 99-1751/40	TWS 99-1751/41	TWS 99-1751/42

8" overall length 200mm

SIZE	STRAIGHT	UP	DOWN
2mm	TWS 99-2030/00	TWS 99-2030/01	TWS 99-2030/02
3mm	TWS 99-2030/10	TWS 99-2030/11	TWS 99-2030/12
4mm	TWS 99-2030/20	TWS 99-2030/21	TWS 99-2030/22
5mm	TWS 99-2030/30	TWS 99-2030/31	TWS 99-2030/32
6mm	TWS 99-2030/40	TWS 99-2030/41	TWS 99-2030/42

FERRIS SMITH PITUITARY/FORAMINOTOMY DESIGN

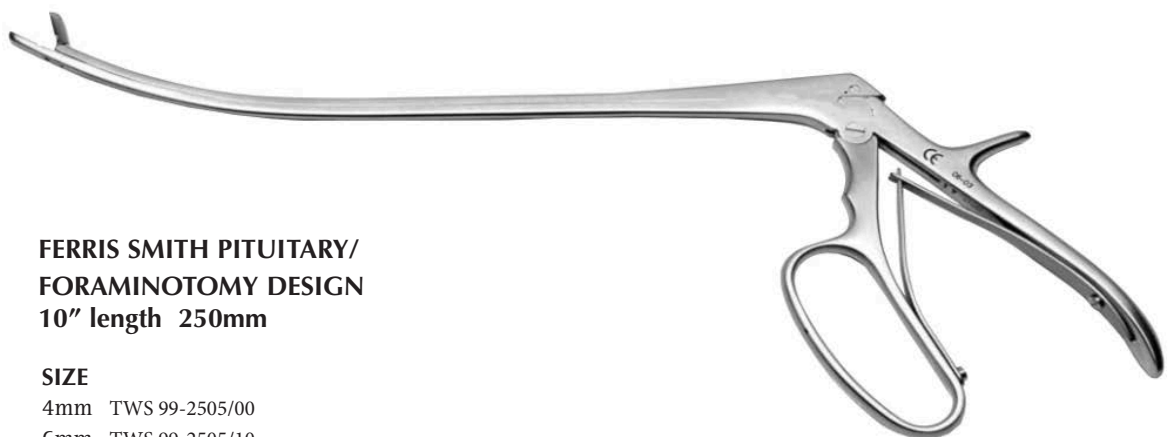

FERRIS SMITH PITUITARY/ FORAMINOTOMY DESIGN 10" length 250mm

SIZE	
4mm	TWS 99-2505/00
6mm	TWS 99-2505/10

Custom bends available upon request.

ANTERIOR FERRIS SMITH PITUITARY RONGEURS

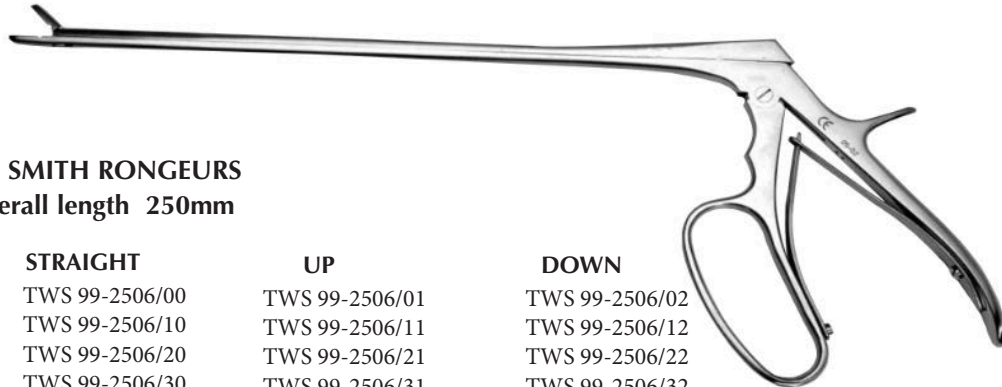

FERRIS SMITH RONGEURS 10" overall length 250mm

SIZE	STRAIGHT	UP	DOWN
2mm	TWS 99-2506/00	TWS 99-2506/01	TWS 99-2506/02
3mm	TWS 99-2506/10	TWS 99-2506/11	TWS 99-2506/12
4mm	TWS 99-2506/20	TWS 99-2506/21	TWS 99-2506/22
5mm	TWS 99-2506/30	TWS 99-2506/31	TWS 99-2506/32
6mm	TWS 99-2506/40	TWS 99-2506/41	TWS 99-2506/42

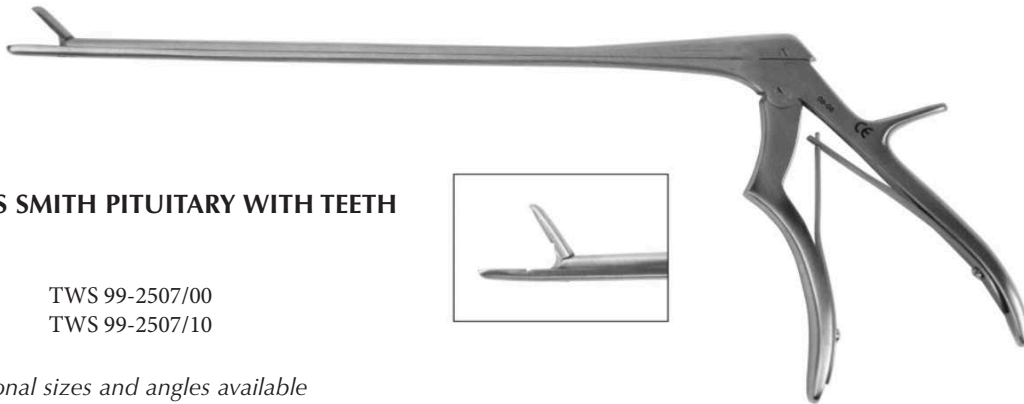

FERRIS SMITH PITUITARY WITH TEETH

SIZE	
3mm	TWS 99-2507/00
5mm	TWS 99-2507/10

Additional sizes and angles available upon request.

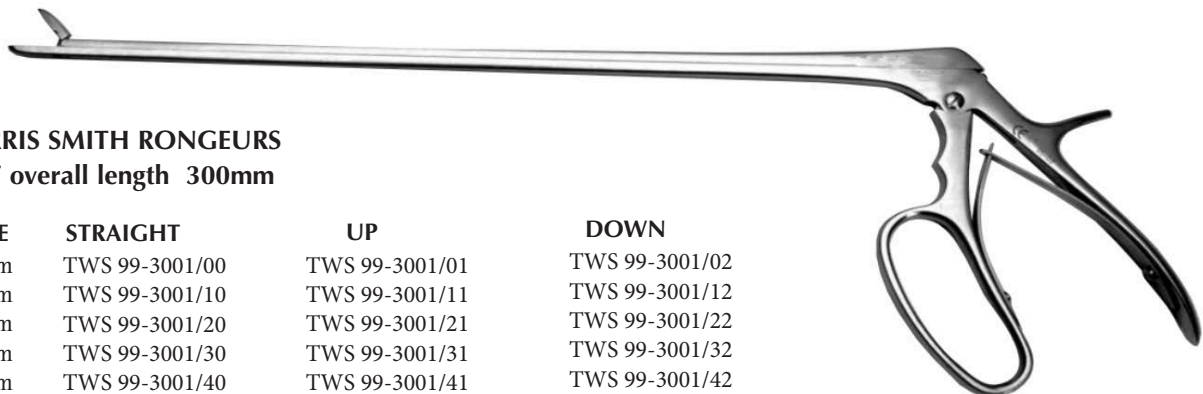

FERRIS SMITH RONGEURS 12" overall length 300mm

SIZE	STRAIGHT	UP	DOWN
2mm	TWS 99-3001/00	TWS 99-3001/01	TWS 99-3001/02
3mm	TWS 99-3001/10	TWS 99-3001/11	TWS 99-3001/12
4mm	TWS 99-3001/20	TWS 99-3001/21	TWS 99-3001/22
5mm	TWS 99-3001/30	TWS 99-3001/31	TWS 99-3001/32
6mm	TWS 99-3001/40	TWS 99-3001/41	TWS 99-3001/42

INTERVERTEBRAL DISCECTOMY RONGEURS

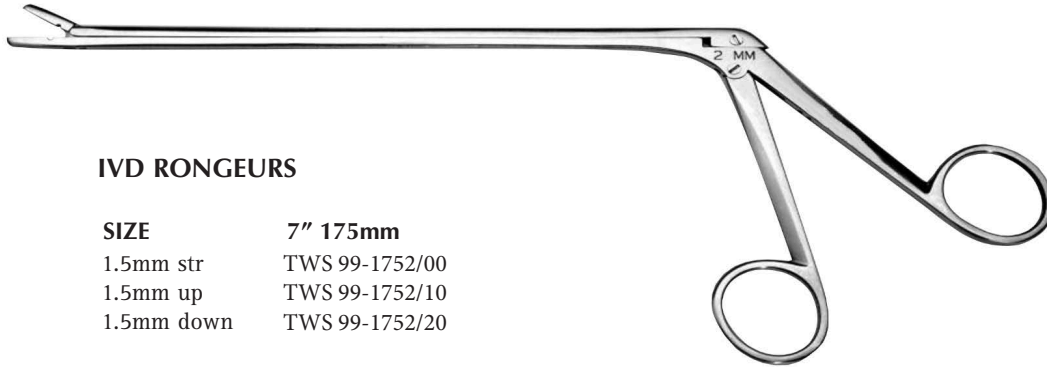

IVD RONGEURS

SIZE	7" 175mm
1.5mm str	TWS 99-1752/00
1.5mm up	TWS 99-1752/10
1.5mm down	TWS 99-1752/20

CUSHING IVD RONGEURS 2 X 10MM

SIZE	7" 175mm	9" 230mm
2mm str	TWS 99-1752/00	TWS 99-2300/00
2mm up	TWS 99-1752/10	TWS 99-2300/10
2mm dwn	TWS 99-1752/20	TWS 99-2300/20

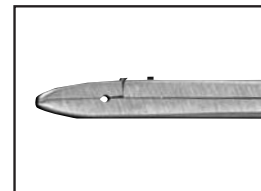

STRAIGHT

LOVE IVD RONGEURS 3 X 10MM

SIZE	7" 175mm	9" 230mm
3mm str	TWS 99-1753/00	TWS 99-2301/00
3mm up	TWS 99-1753/10	TWS 99-2301/10
3mm dwn	TWS 99-1753/20	TWS 99-2301/20

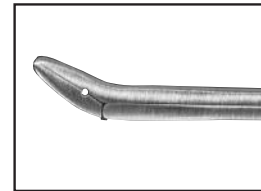

UP

SPURLING IVD RONGEURS 4 X 10MM

SIZE	7" 175mm	9" 230mm
4mm str	TWS 99-1754/00	TWS 99-2302/00
4mm up	TWS 99-1754/10	TWS 99-2302/10
4mm dwn	TWS 99-1754/20	TWS 99-2302/20

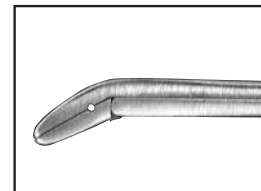

DOWN

CASPAR STYLE IVD PITUITARY

Teeth on back of Cup
Fenestrated Cup

SIZE	7" 175mm
2mm	TWS 99-1755/00
3mm	TWS 99-1755/10
4mm	TWS 99-1755/20

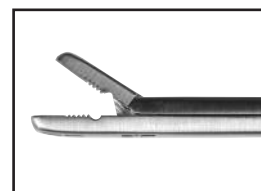

MICRO PITUITARY RONGEURS



TW Surgical

MICRO DECKER PITUITARY RONGEURS

6" length 150mm

	SIZE	STRAIGHT	UP	LEFT	RIGHT	DOWN
Delicate	1.5mm	TWS 99-1500/00	TWS 99-1500/01	TWS 99-1500/02	TWS 99-1500/03	TWS 99-1500/04
Standard	2mm	TWS 99-1500/10	TWS 99-1500/11			
With Teeth	2mm	TWS 99-1500/20				

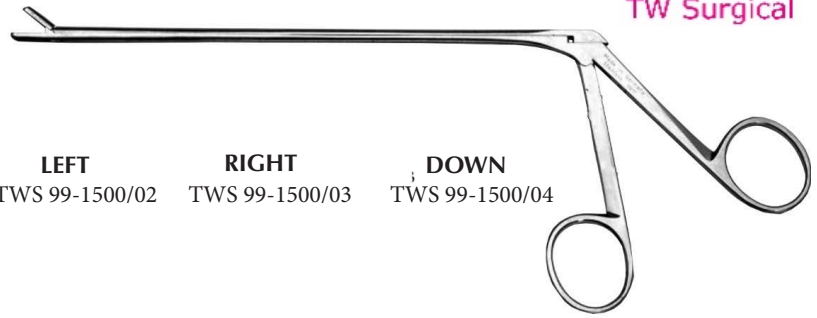

MICRO DECKER PITUITARY RONGEURS

8" length 200mm

	SIZE	STRAIGHT	UP	LEFT	RIGHT	DOWN BITE
Standard	2mm	TWS 99-2040/00	TWS 99-2040/01	TWS 99-2040/02	TWS 99-2040/03	TWS 99-2040/04
With Teeth	2mm	TWS 99-2040/10				

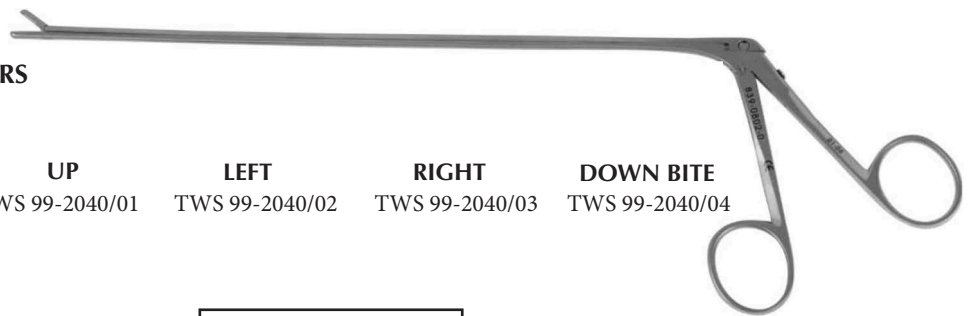

TEETH



UP BITE

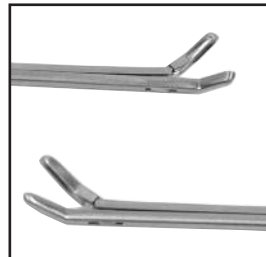

LEFT & RIGHT

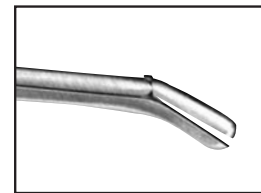

DOWN BITE

PEAPOD RONGEURS

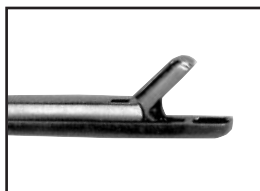

PEAPOD RONGEURS

Jaw 2 x 6mm

5.5" length 140mm

2mm up	TWS 1400/00
2mm straight	TWS 1400/10

7" length 175mm

2mm up	TWS 1756/00
2mm straight	TWS 1756/10

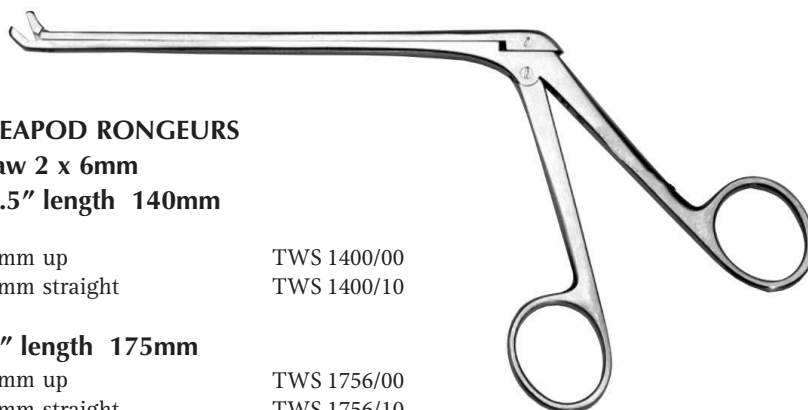

WILLIAMS PITUITARY RONGEURS

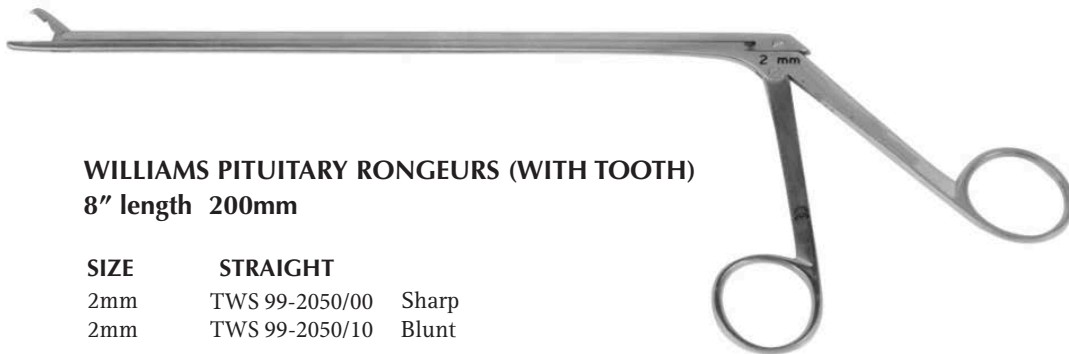

WILLIAMS PITUITARY RONGEURS (WITH TOOTH)
8" length 200mm

SIZE	STRAIGHT		
2mm	TWS 99-2050/00	Sharp	
2mm	TWS 99-2050/10	Blunt	

TOOTHED PITUITARY IVD RONGEURS

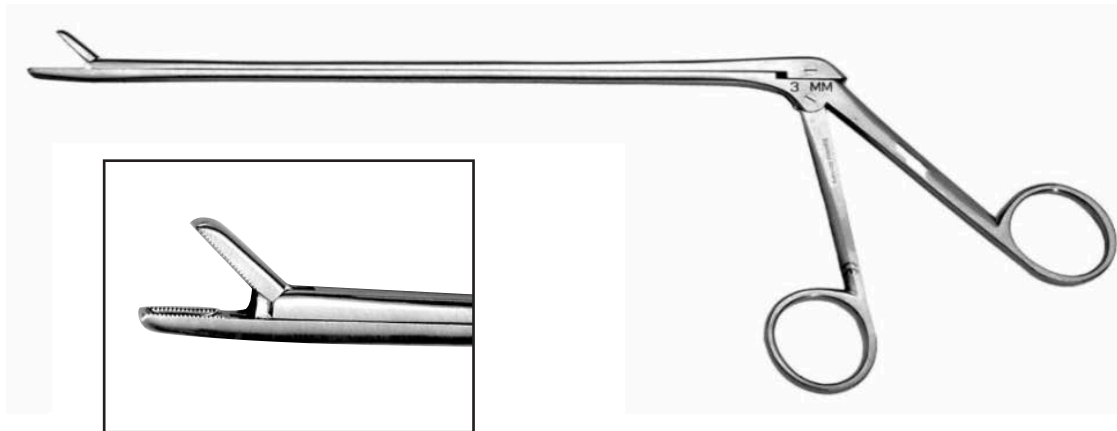

TOOTHED PITUITARY IVD RONGEURS
8" length 200mm

SIZE	STRAIGHT	UP	DOWN BITE
1.5mm	TWS 99-2060/00	TWS 99-2060/01	TWS 99-2060/02
2mm	TWS 99-2060/10	TWS 99-2060/11	TWS 99-2060/12
3mm	TWS 99-2060/20	TWS 99-2060/21	TWS 99-2060/22
4mm	TWS 99-2060/30	TWS 99-2060/31	TWS 99-2060/32
5mm	TWS 99-2060/40	TWS 99-2060/41	TWS 99-2060/42

TOOTHED PITUITARY RONGEURS

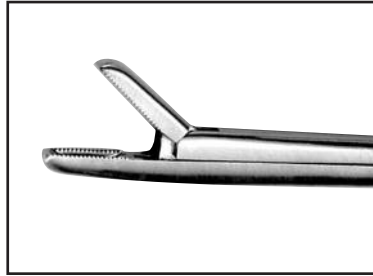
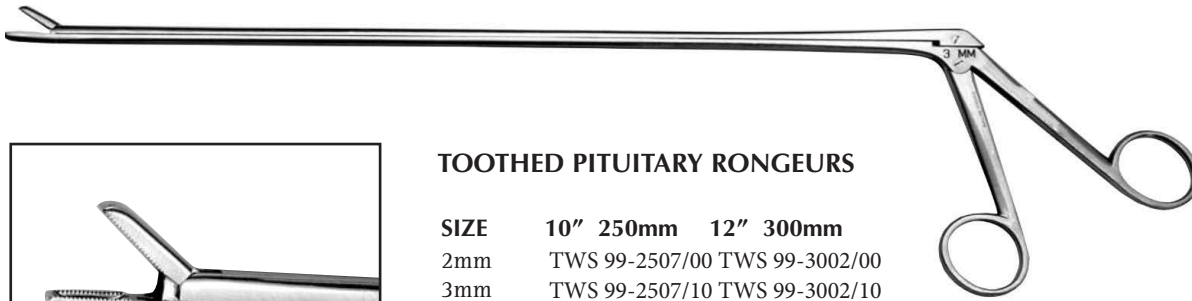

TOOTHED PITUITARY RONGEURS

SIZE	10" 250mm	12" 300mm
2mm	TWS 99-2507/00	TWS 99-3002/00
3mm	TWS 99-2507/10	TWS 99-3002/10
4mm	TWS 99-2507/20	TWS 99-3002/20
5mm	TWS 99-2507/30	TWS 99-3002/30

TOOTHED GRASPING FORCEP

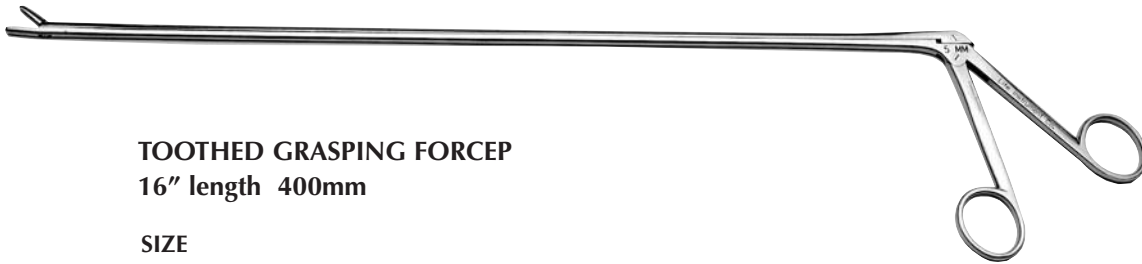

TOOTHED GRASPING FORCEP 16" length 400mm

SIZE	
5mm	TWS 99-4000/00

DISC RONGEURS



DISC RONGEURS 10" overall length 250 mm

Straight Shaft	TWS 99-2508/00
Curved Shaft	TWS 99-2508/10

ANTERIOR VERTEBRAL BODY RONGEURS

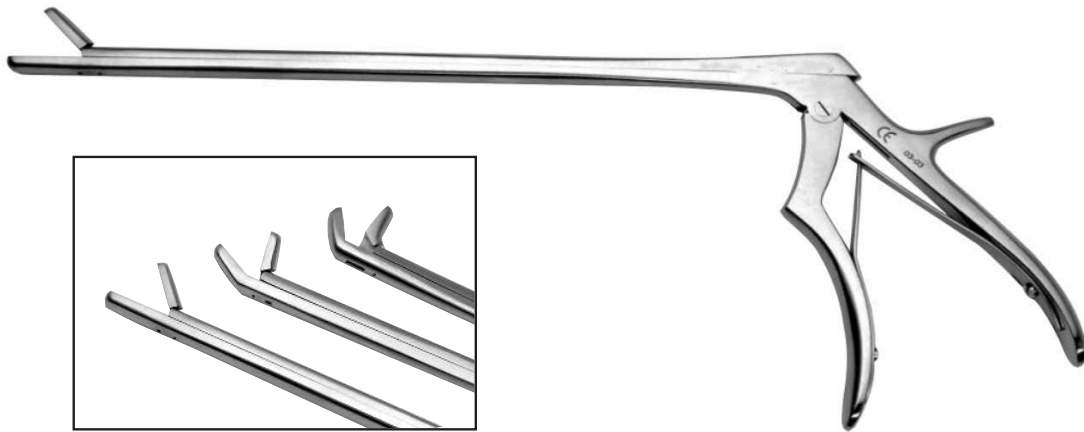

HODGSON STYLE

10" length 250mm

8mm Straight	TWS 99-2509/00
8mm Angled 30° up	TWS 99-2509/10
8mm Angled 60° up	TWS 99-2509/20
8mm Straight with Teeth	TWS 99-2508/30

12" length 300mm

8mm Straight	TWS 99-3003/00
8mm Straight with Teeth	TWS 99-3003/10

ANTERIOR DISC RONGEURS

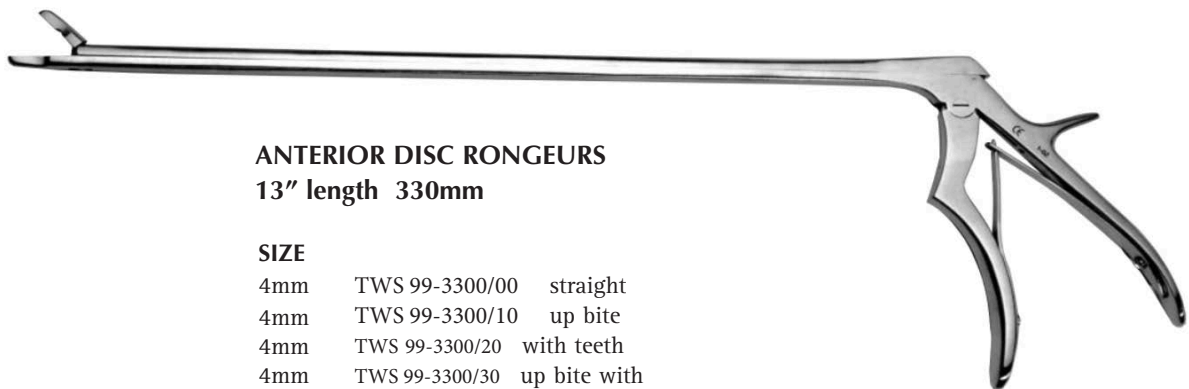

ANTERIOR DISC RONGEURS

13" length 330mm

SIZE

4mm	TWS 99-3300/00	straight
4mm	TWS 99-3300/10	up bite
4mm	TWS 99-3300/20	with teeth
4mm	TWS 99-3300/30	up bite with
6mm	TWS 99-3300/40	straight

ANTERIOR PITUITARY RONGEURS

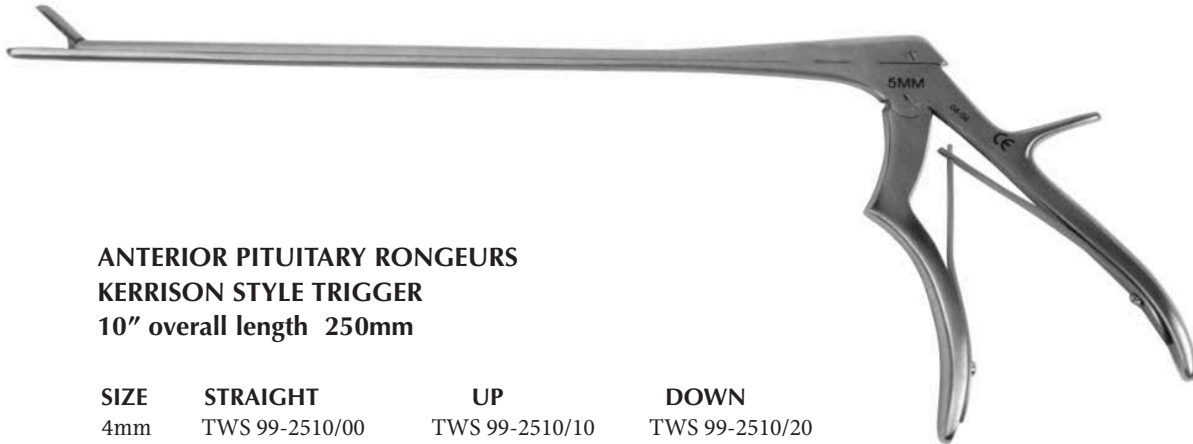

**ANTERIOR PITUITARY RONGEURS
KERRISON STYLE TRIGGER
10" overall length 250mm**

SIZE	STRAIGHT	UP	DOWN
4mm	TWS 99-2510/00	TWS 99-2510/10	TWS 99-2510/20

12" overall length 300mm

SIZE	STRAIGHT	UP	DOWN
4mm	TWS 99-3002/00	TWS 99-3002/10	TWS 99-3002/20

LATERAL CURVE PITUITARY RONGEURS

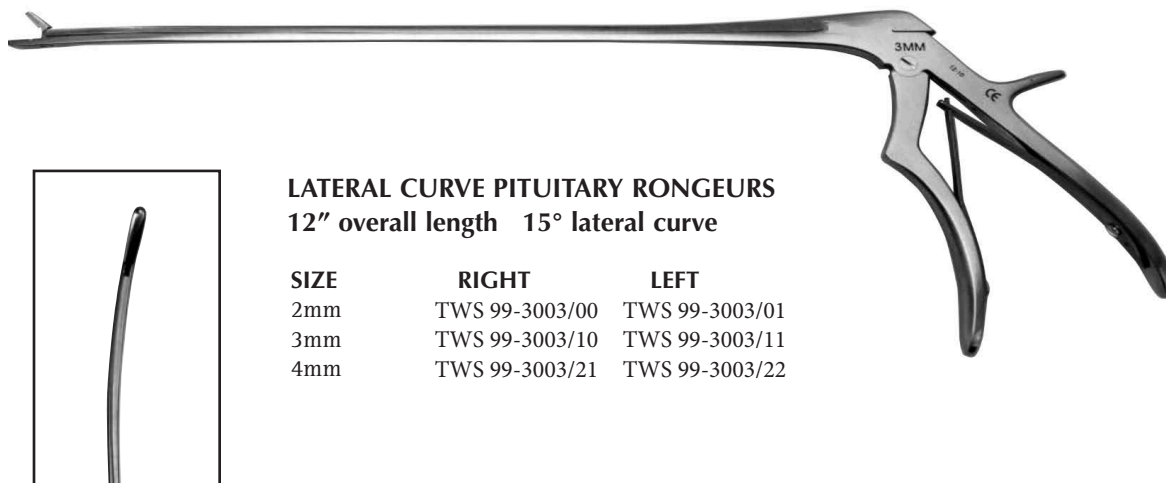

**LATERAL CURVE PITUITARY RONGEURS
12" overall length 15° lateral curve**

SIZE	RIGHT	LEFT
2mm	TWS 99-3003/00	TWS 99-3003/01
3mm	TWS 99-3003/10	TWS 99-3003/11
4mm	TWS 99-3003/21	TWS 99-3003/22

DURASAFE RONGEUR



DURASAFE RONGEUR
Reverse Biting Action Rongeur
10" overall length 250mm

SIZE

2mm	TWS 99-2520/00
3mm	TWS 99-2520/10
4mm	TWS 99-2520/20

Instrument can be opened up for cleaning.

BAYONET KERRISON RONGEURS

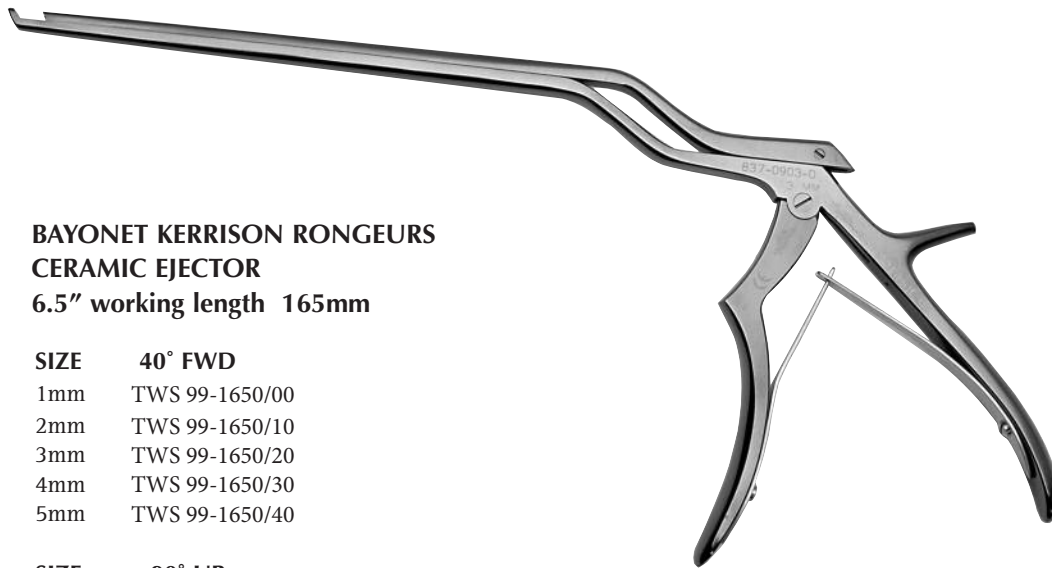

BAYONET KERRISON RONGEURS CERAMIC EJECTOR

6.5" working length 165mm

SIZE 40° FWD

1mm	TWS 99-1650/00
2mm	TWS 99-1650/10
3mm	TWS 99-1650/20
4mm	TWS 99-1650/30
5mm	TWS 99-1650/40

SIZE 90° UP

2mm	TWS 99-1650/50
3mm	TWS 99-1650/60
4mm	TWS 99-1650/70

See page 3.6 for Open Up Bayonet Kerrison.

BAYONET PITUITARY RONGEURS

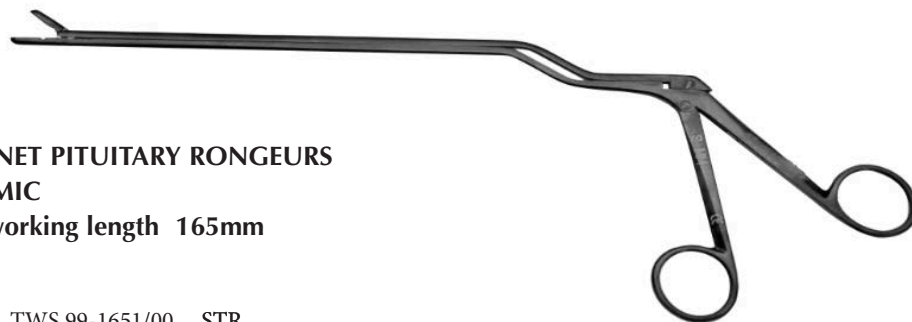

BAYONET PITUITARY RONGEURS CERAMIC

6.5" working length 165mm

SIZE

2mm	TWS 99-1651/00	STR
3mm	TWS 99-1651/10	STR
4mm	TWS 99-1651/20	STR

2mm	TWS 99-1651/30	STR
3mm	TWS 99-1651/40	STR
4mm	TWS 99-1651/50	STR

Downbite Pituitary available upon request.

LEKSELL RONGEURS



LEKSELL RONGEURS 9" length 230mm

SIZE	SLIGHT CURVE	FULL CURVE
2mm	TWS 99-2300/00	TWS 99-2300/01
4mm	TWS 99-2300/10	TWS 99-2300/11
8mm	TWS 99-2300/20	TWS 99-2300/21

FLAT NOSE LEKSELL (see inset)

SIZE	
8mm	TWS 99-2301/00



Excellent for removing osteophytes.

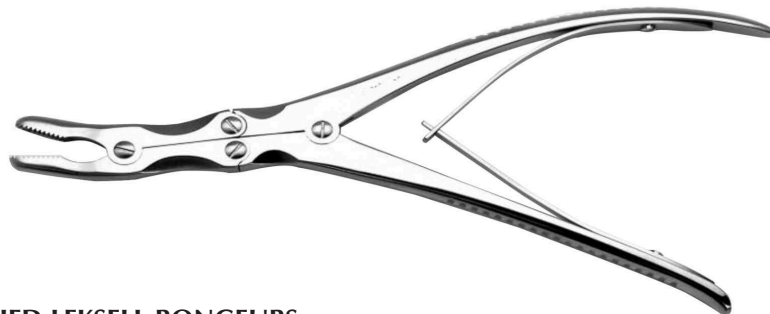

TOOTHED LEKSELL RONGEURS 9" length 230mm

SIZE	
4mm	TWS 99-2302/00
8mm	TWS 99-2302/10



ADSON RONGEURS

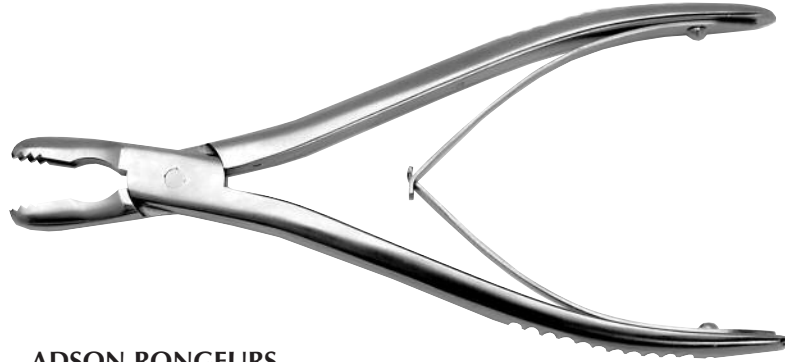

ADSON RONGEURS
8" length 200mm

8mm smooth	TWS 99-2070/00
8mm teeth	TWS 99-2070/10

ZIELKE RONGEUR



ZIELKE RONGEUR
8" length 200mm

5mm	TWS 99-2080/00
-----	----------------

BEYER RONGEUR



BEYER RONGEUR
7" length 175mm

3mm Curved	TWS 99-1757/00
------------	----------------

RUSKIN RONGEUR
9" length 230mm

6mm Straight	TWS 99-2303/00
6mm Angled	TWS 99-2303/10

MAZUR RONGEUR

Unique patented concave tip allows sculpturing of anterior cervical spine without clogging.
Improves strength of construct. Allows working in tight spaces.



MR-001

MAZUR RONGEUR

TWS 99-1000/00 Large 9" length
TWS 99-1000/10 Small 7" length

Available in 2 sizes.



SMITH PETERSON RONGEURS

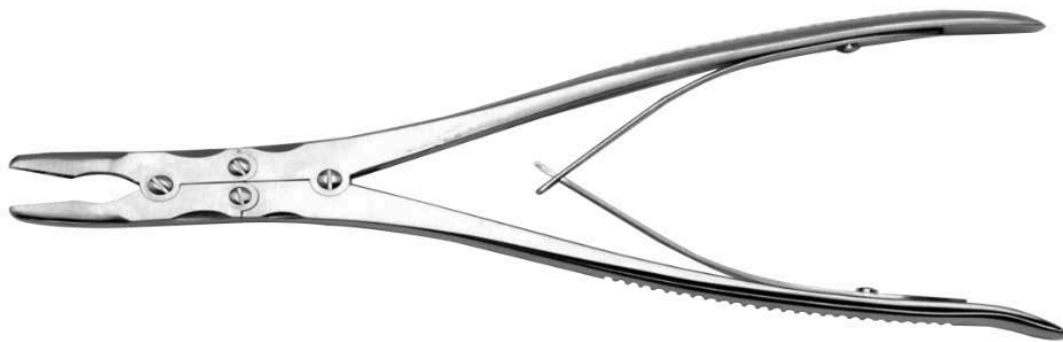

SMITH PETERSON RONGEURS 9" length 230mm

SIZE	STRAIGHT	ANGLED
2mm	TWS 99-2304/00	TWS 99-2304/01
4mm	TWS 99-2304/10	TWS 99-2304/11
6mm	TWS 99-2304/20	TWS 99-2304/21
7mm	TWS 99-2304/30	TWS 99-2304/31

STILLE HORSLEY BONE CUTTER



STILLE HORSELY BONE CUTTER
12" length 300mm

TWS 99-3004/00

ANTERIOR DOUBLE ACTION RONGEURS



ANTERIOR DOUBLE ACTION RONGEURS
14" length 355mm

5mm	TWS 3550/00
8mm	TWS 3550/10
12mm	TWS 3550/20

With teeth

5mm	TWS 3550/30
8mm	TWS 3550/40
12mm	TWS 3550/50

FRAZIER SUCTION TUBES



FRAZIER SUCTION TUBES

7" from bend

6FR	TWS 81-7000/00
8FR	TWS 81-7000/10
10FR	TWS 81-7000/20
12FR	TWS 81-7000/30
14FR	TWS 81-7000/40

8" from bend

10FR	TWS 81-8000/00
12FR	TWS 81-8000/10

10" from bend

10FR	TWS 81-1000/00
12FR	TWS 81-1000/20

Custom lengths available upon request.

*** Large Aluminum Handle for Excellent Control ***

FRAZIER SUCTION TUBES



FRAZIER SUCTION TUBES

Stainless Steel Thumbgrip

140mm (115mm from bend)

5.5" (4.5" from bend)

5FR	TWS 81-1150/00
7FR	TWS 81-1150/10
8FR	TWS 81-1150/20
9FR	TWS 81-1150/30
10FR	TWS 81-1150/00

180mm (150mm from bend)

7" (6" from bend)

3FR	TWS 81-1500/00
5FR	TWS 81-1150/10
7FR	TWS 81-1150/20
9FR	TWS 81-1150/30
11FR	TWS 81-1150/40
12FR	TWS 81-1150/50

200mm (180mm from bend)

8" (7" from bend)

7FR	TWS 81-2000/00
9FR	TWS 81-2000/10
11FR	TWS 81-2000/20
12FR	TWS 81-2000/30

230mm (200mm from bend)

9" (8" from bend)

7FR	TWS 81-2300/00
9FR	TWS 81-2300/10
11FR	TWS 81-2300/20
14FR	TWS 81-2300/30

280mm (250mm from bend)

11" (10" from bend)

9FR	TWS 81-2800/00
10FR	TWS 81-2800/10
12FR	TWS 81-2800/20

FUKASHIMA STYLE SUCTION TUBES



FUKASHIMA STYLE SUCTION TUBES Malleable Tapered Teardrop Suction Tube Stainless Steel

120mm (100mm from bend) 5" (4" from bend)

2FR	TWS 81-1200/00
3FR	TWS 81-1200/10
4FR	TWS 81-1200/20
5FR	TWS 81-1200/30
6FR	TWS 81-1200/40
7FR	TWS 81-1200/50
8FR	TWS 81-1200/60
10FR	TWS 81-1200/70

200mm (170mm from bend) 8" (7" from bend)

4FR	TWS 81-2001/00
5FR	TWS 81-2001/10
6FR	TWS 81-2001/20
7FR	TWS 81-2001/30
8FR	TWS 81-2001/40
9FR	TWS 81-2001/50
10FR	TWS 81-2001/60

160mm (130mm from bend) 6.5" (5" from bend)

4FR	TWS 81-1600/00
6FR	TWS 81-1600/10
8FR	TWS 81-1600/20
10FR	TWS 81-1600/30
12FR	TWS 81-1600/00

230mm (200mm from bend) 9" (8" from bend)

9FR	TWS 81-2301/00
10FR	TWS 81-2301/10

CONE SUCTION TUBES

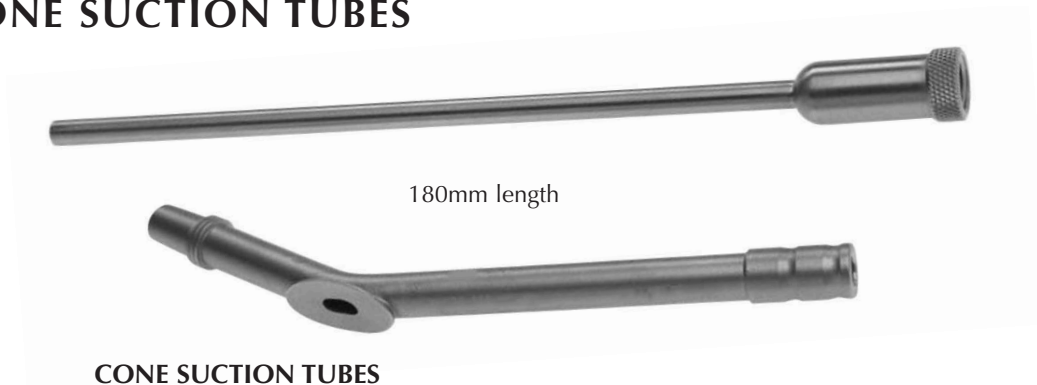

CONE SUCTION TUBES

Handle

TWS 81-1800/00

Tubes 180mm length

3mm	TWS 81-1801/00
4mm	TWS 81-1801/10
5mm	TWS 81-1801/20

ADSON SUCTION TUBES



ADSON SUCTION TUBES

12FR	TWS 81-1201/00
15FR	TWS 81-1201/10

SUCTION TUBE WITH ATRAUMATIC TIP



SUCTION TUBE WITH ATRAUMATIC TIP 4" from bend (100mm from bend)

5FR	TWS 81-1001/00
7FR	TWS 81-1001/20
10FR	TWS 81-1001/30

Custom lengths available upon request

SCOVILLE RETRACTOR WITH SUCTION TIP

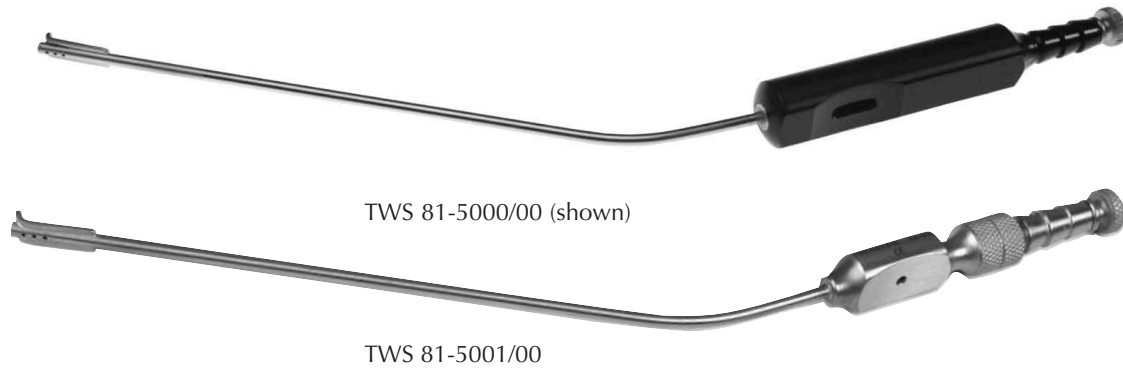

SCOVILLE RETRACTOR WITH SUCTION TIP 5" from bend

5mm	TWS 81-5002/00	8 FR	
8mm	TWS 81-5002/10	8 FR	
5mm	TWS 81-5002/20	8 FR	with Stainless Steel Thumbgrip

SCOVILLE RETRACTOR SUCTION WITH LIGHT



SCOVILLE RETRACTOR SUCTION WITH LIGHT

5mm TWS 81-5003/00
** 3 INSTRUMENTS IN ONE **

ASDOURIAN SUCTION TUBES



ASDOURIAN SUCTION TUBES 20 FR

5" from the bend	TWS 81-2002/00
9" from the bend	TWS 81-2002/10

DISK MARKERS



CERVICAL DISK MARKER

The markers easily identify the disk level on the x-ray.
Markers are 10cm in length with a 7mm protective ballstop.

Single	TWS 72-1051/10
Set of Three	TWS 72-1051/30



LUMBAR DISK MARKER

The markers easily identify the disk level on the x-ray.
Markers are 17.5cm in length with a 12.5mm protective ballstop.

Single	TWS 72-1031/01
Set of Three	TWS 72-1031/03

Saves Time • Reusable • Autoclavable

DISK SPACER SET



DISK SPACER SET

SIZE

9mm	TWS 72-1042/02
10mm	TWS 72-1042/04
11mm	TWS 72-1042/06
12mm	TWS 72-1042/08
13mm	TWS 72-1042/10
14mm	TWS 72-1042/12
16mm	TWS 72-1042/14
18mm	TWS 72-1042/16
T-Insertor	TWS 72-1042/18

“WHITE” RUSSIAN FORCEP



Tamp End

“WHITE” RUSSIAN FORCEP

New forcep designed to facilitate collection, delivery and packing of bone graft. Very useful for bone grafting adjacent to instrumentation, under rods and crosslinks.

8"	TWS 72-1051/30
10"	TWS 72-1051/60

JEFFERSON FORCEP



JEFFERSON FORCEP 7" length 175mm

1 x 2 Teeth	TWS 72-1055/01
Serrated	TWS 72-1055/02



**ARM WITH UNIVERSAL
ATTACHMENT (A) Table Clamp
Included**

400mm column TWS 72-1061/02

**ARM WITH LOW PROFILE ATTACHMENT (B)
Holds Transverse Cervical Retractor Frame
Eliminates Cervical Retraction Movement During
Operation Table Clamp Included**

TWS 72-1061/01

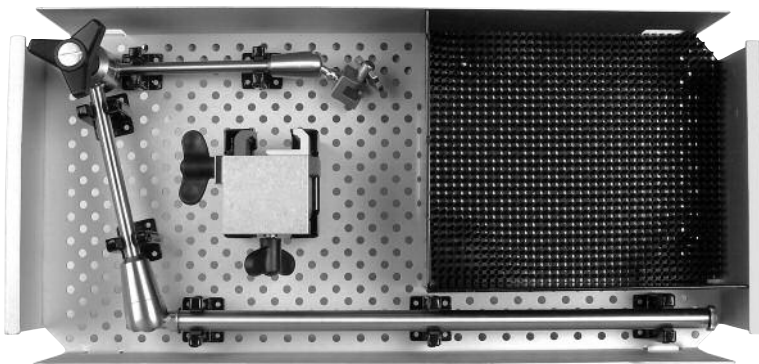
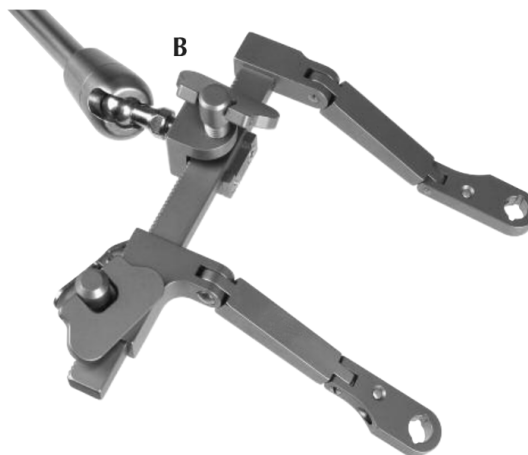

TWS 72-1061/03 Sterilization Insert to hold Arm

L-SHAPE COLUMN WITH ARTICULATING ARM

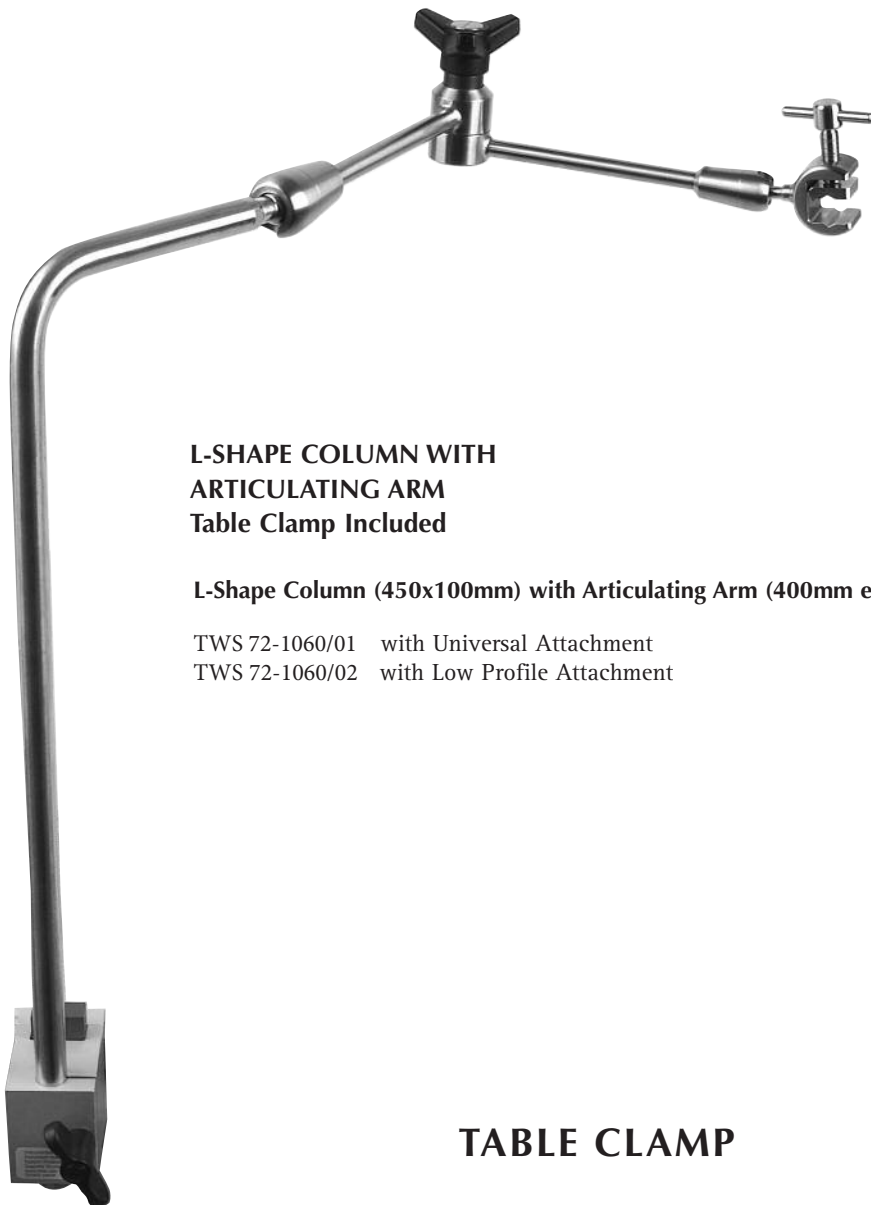

L-SHAPE COLUMN WITH ARTICULATING ARM Table Clamp Included

L-Shape Column (450x100mm) with Articulating Arm (400mm extension)

TWS 72-1060/01 with Universal Attachment

TWS 72-1060/02 with Low Profile Attachment

TABLE CLAMP

TABLE CLAMP

Stainless Steel

TWS 72-1061/00

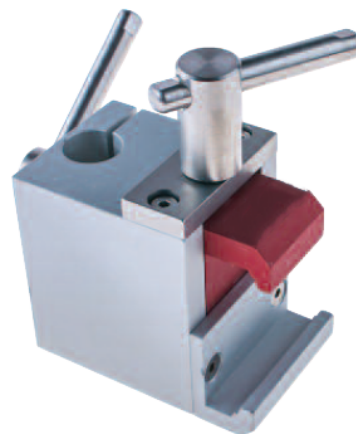

FUNNEL



FUNNEL Stainless Steel

Bone Funnel Cup	TWS 72-1078/01
8.5" Tube	TWS 72-1078/03
6.5" Tube	TWS 72-1078/05

**Cup disassembles from tube for easy cleaning.
* Sold Separately ***

PLUNGER



PLUNGER

TWS 72-1046/02	for 8.5" Tube
TWS 72-1046/03	for 6.5" Tube

DURA & VESSEL REPAIR INSTRUMENTS



TITANIUM MICRO NEEDLEHOLDER

12" length 300mm

Curved with Lock Round Handle for Better Control

TWS 72-1050/11

8" length 200mm

TWS 72-1050/13



BAYONET MICRO NEEDLEHOLDER

12" length 300mm

Curved with Lock

TWS 72-1050/20



ATRAUMATIC MICRO FORCEPS

Debakey Style 1.2mm Round Handle for Better Control

12" length 300mm

TWS 72-1050/60

7" length 175mm

TWS 72-1050/80

DURA & VESSEL REPAIR INSTRUMENTS



MICRO SCISSORS
Stainless Steel
Curved Round Handle for Better Control
12" length 300mm

TWS 72-1065/01

8" length 200mm

TWS 72-1065/02



BAYONET MICRO SCISSORS
Stainless Steel
Curved Round Handle for Better Control
12" length 300mm

TWS 72-1065/03

KNOT PUSHER



KNOT PUSHER

4" working length
6" working length
8" working length

TWS 72-1067/01
TWS 72-1067/02
TWS 72-1067/03



KNOT PUSHER

TWS 72-1068/01

BAYONET BIPOLAR FORCEP



BAYONET BIPOLAR FORCEP 6" working length 1.0mm tip

TWS 72-1069/01 Straight Tip
TWS 72-1069/02 Angled Tip

KNIFE BLADE HOLDER



KNIFE BLADE HOLDER 6" working length

TWS 72-1071/03

MICRO SCISSOR

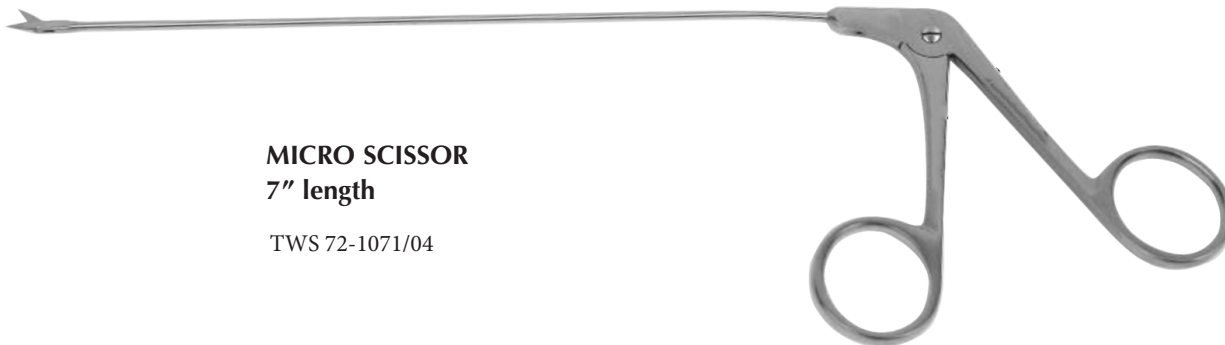

MICRO SCISSOR 7" length

TWS 72-1071/04

PERSONALIZED COBB ELEVATOR



WIRE TWISTER

** NEW **

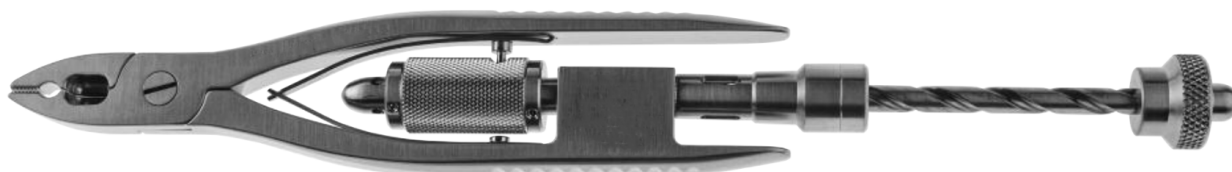

WIRE TWISTER

TWS 72-1037/01

QUEEN SQUARE PERCUSSION HAMMER



QUEEN SQUARE PERCUSSION HAMMER

Nylon hammer TWS 72-1037/02

ILLUMINATION SYSTEM

Any Retractor can be modified with an attachment to hold the light bundle.

LED LIGHT 50W

TWS 72-1038/01

CABLE

SIZE

4.5mm	6' length	TWS 72-1038/02
5mm	6' length	TWS 72-1038/03



PATTIE TRAY



PATTIE TRAY

TWS 72-1091/01

DOTY-BOYD PATTIE TRAY



DOTY-BOYD PATTIE TRAY

TWS 72-1091/06

PEDICLE PROBES



CURVED TAPERED TIP PROBE
Silicone Handle 10" overall length

TWS 72-1043/04



STRAIGHT TAPERED TIP PROBE
Silicone Handle 10" overall length

TWS 72-1043/06



PENFIELD STYLE PROBE
Silicone Handle 10" overall length

4mm TWS 72-1043/07 slight curve
4mm TWS 72-1043/08 flat



PEDICLE PROBE
9" overall length

TWS 72-1043/09 slight curve
TWS 72-1043/10 straight