



TW SURGICAL

## Ortho





<b>Retractors</b>	<b>3</b>
<b>Elevators</b>	<b>7</b>
<b>Hooks</b>	<b>8</b>
<b>Forceps</b>	<b>9</b>
<b>Osteotome</b>	<b>13</b>
<b>Bone rongeur</b>	<b>16</b>
<b>Tubes</b>	<b>18</b>



TW SURGICAL

hand & foot

Ortho



**Karmody  
spring wire retractor**  
with 2 blades  
TWS-1001/1 - 89mm  
TWS-1001/2 - 134mm



**spring wire retractor**  
TWS-1001/3 - 76mm



**approximator bulldog**  
TWS-1001/4 - 40mm



**Alar Converse**  
finger wound retractor  
TWS-1001/5 - 117mm



**Hays**  
phalangen elevator  
TWS-1001/6 - 3mm  
TWS-1001/7 - 5mm  
TWS-1001/8 - 7mm



**lamina and bone spreader**  
flat surface  
TWS-1001/9 - 140mm, 25° jaw



**lamina and bone spreader**  
1x2 teeth  
TWS-1001/10 - 140mm, 25° jaw



**lamina and bone spreader**  
with speadlock, 1x2 teeth  
TWS-1001/11 - 140mm, 25° jaw



**lamina and bone spreader** with  
speadlock, 1x2 teeth  
TWS-1001/12 - 140mm, 75° jaw

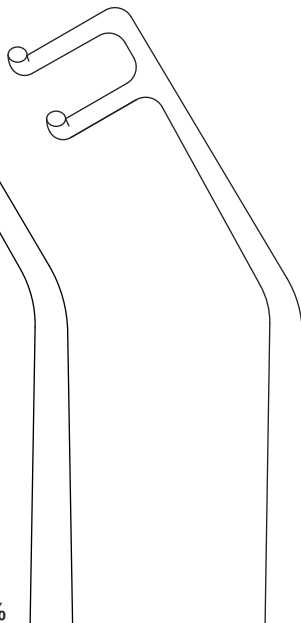
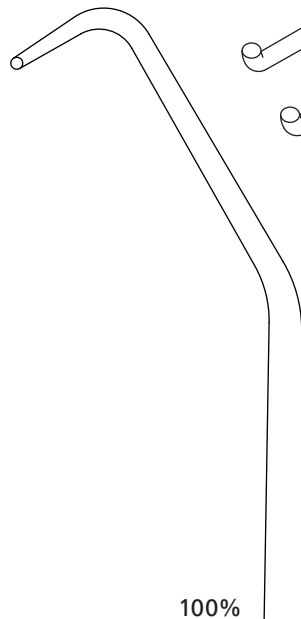
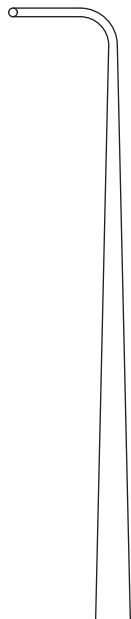

100%

**Koelbel**  
tissue & muscle spreader  
single-pronged, straight  
arms, fine tips  
TWS-1001/13 - 180mm

**Koelbel**  
tissue & muscle spreader  
single-pronged,  
angled arms  
TWS-1001/14 - 180mm

**Koelbel**  
tissue & muscle spreader  
2 blunt prongs  
angled arms  
TWS-1001/15 - 180mm

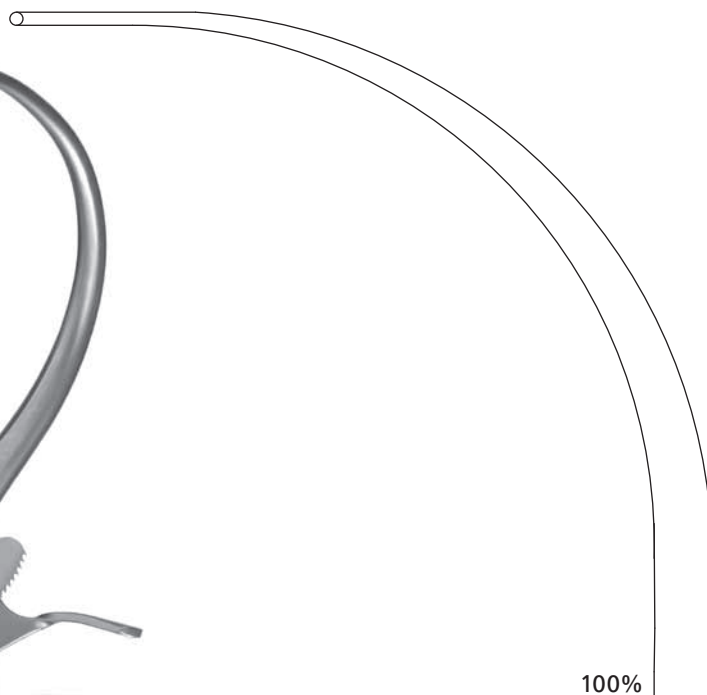

100%

**Koelbel**  
tissue & muscle spreader  
single-pronged  
90° curved arms  
TWS-1001/16 - 165mm



TW SURGICAL

shoulder

Ortho

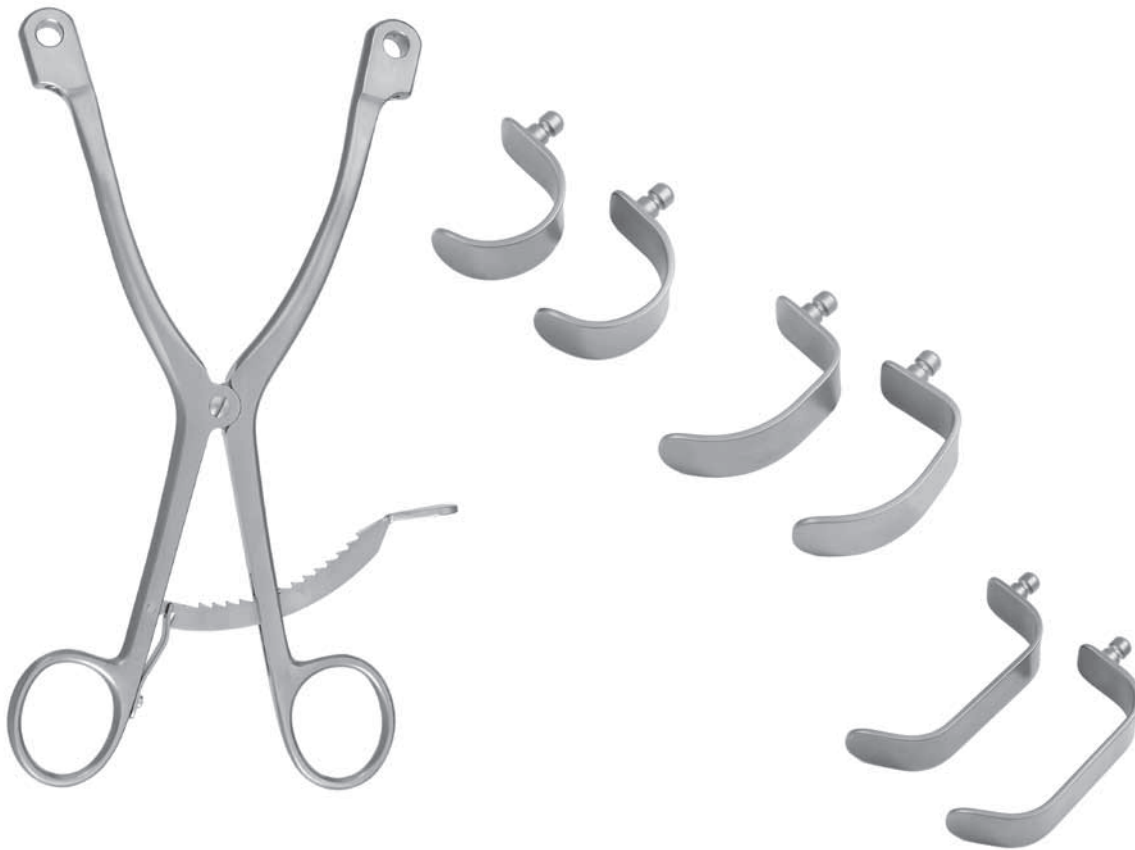

**Koelbel spreader**

TWS-1001/17 - 200mm

**Koelbel blades  
short blades**

TWS-1001/18 SET - 18x36mm pair of short blades

TWS-1001/19 SET - 20x36mm pair of short blades

TWS-1001/20 SET - 36x36mm pair of short blades

**long blades**

TWS-1001/21 SET - 18x53mm pair of long blades

TWS-1001/22 SET - 20x53mm pair of long blades

TWS-1001/23 SET - 36x53mm pair of long blades

**extralong blades**

TWS-1001/24 SET - 18x68mm pair of extralong blades

TWS-1001/25 SET - 20x68mm pair of extralong blades

TWS-1001/26 SET - 36x68mm pair of extralong blades



**blade changing forceps**

TWS-1001/27 - 115mm

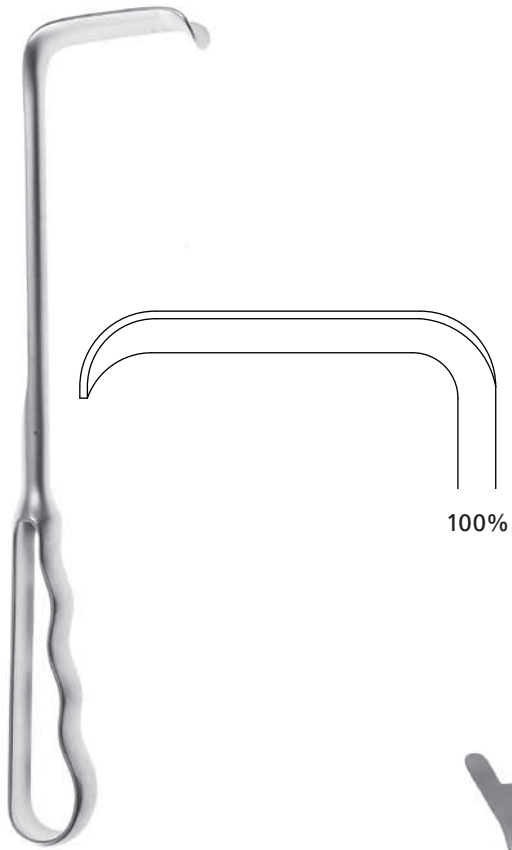

**Richardson hand-held retractor**

TWS-1001/28 - 240mm, 20x55mm

TWS-1001/29 - 240mm, 28x55mm



**Humerus**  
head retractor  
TWS-1001/30 - 180mm



**Humerus**  
head retractor acc. to Fukuda  
TWS-1001/31 - 35/225mm



**elevators**  
2 spikes, strongly cvd.  
TWS-1001/32 - 15/300mm  
TWS-1001/33 - 23/300mm



**elevators**  
2 spikes, curved  
TWS-1001/34 - 15/300mm  
TWS-1001/35 - 20/300mm



**Skid lever** double ended  
TWS-1001/36 - 285mm



**mallet**  
TWS-1001/37 - 244mm



**percussion awl** with  
metal handle  
TWS-1001/38 - 220mm



**penetrating awl**  
TWS-1001/39  
- 185mm



**crochet hook**  
suture passer  
TWS-1001/40  
- 185mm



**suture passer**  
TWS-1001/41  
- 185mm



**penetrating gouge**  
TWS-1001/42  
- 220mm



**Bankart**  
 perforating forceps 170mm  
 TWS-1001/43 - slightly angled  
 TWS-1001/44 - strongly angled

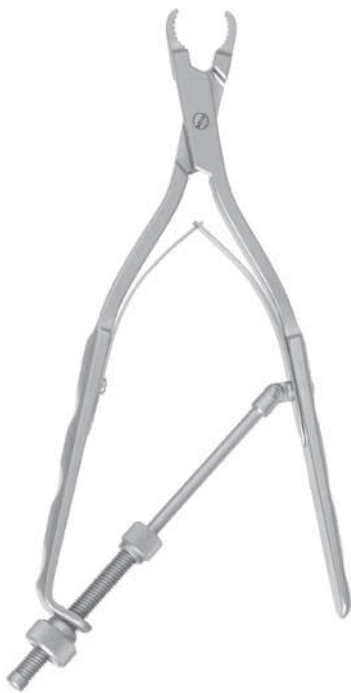

**bone holding forceps 180mm**  
 TWS-1001/45 - str. jaw  
 TWS-1001/46 - ang. jaw

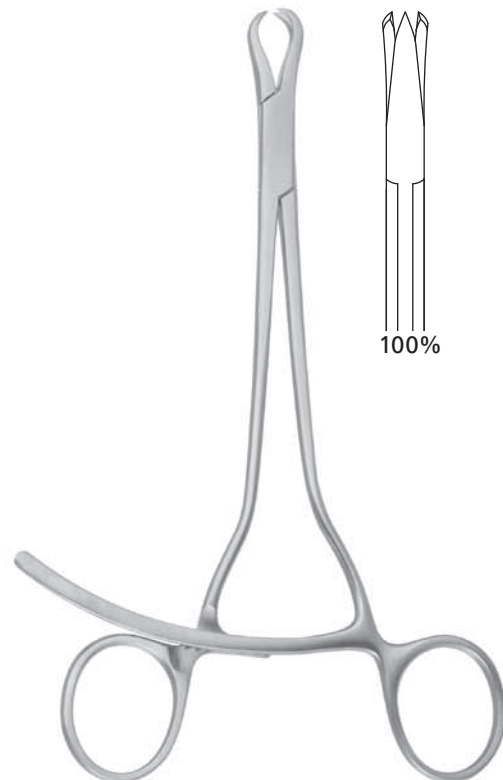

**bone reposition forceps**  
 TWS-1001/47 - 190mm, str.



**Mastin**  
muscle clamp  
TWS-1001/48  
- 172mm, ang. shanks



**Walton**  
meniscus clamp with 12 pins and mouse teeth  
TWS-1001/49 - 186mm, ang. shanks



TW SURGICAL

hand/foot surgery

Ortho

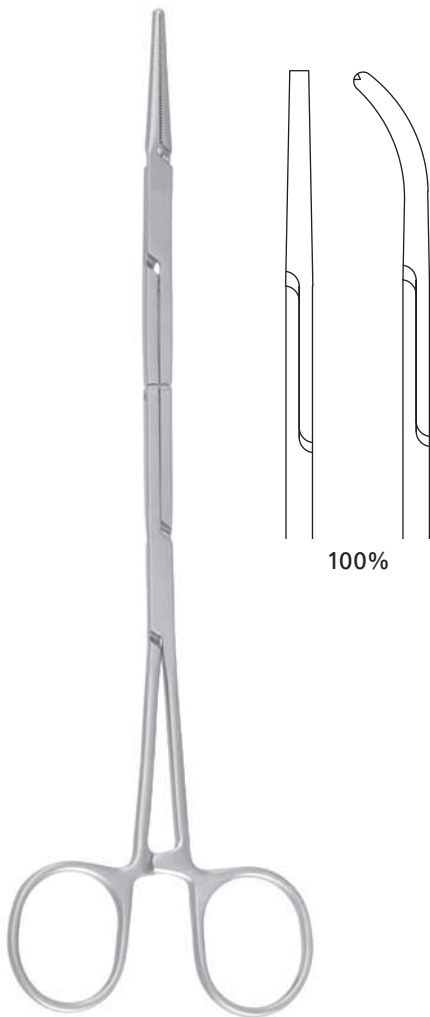

**tendon seizing forceps** double action  
TWS-1001/50 - 205mm, str.  
TWS-1001/51 - 203mm, cvd.

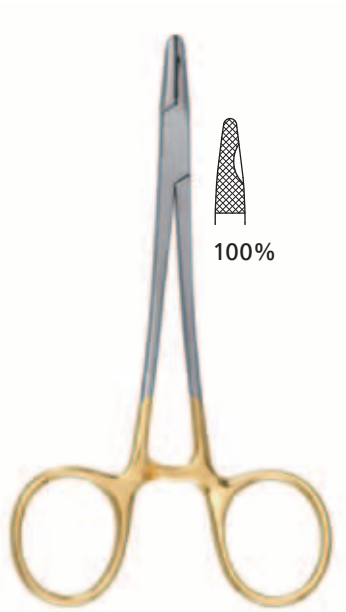

**Neivert *TC***  
TWS-1001/52  
- 126mm

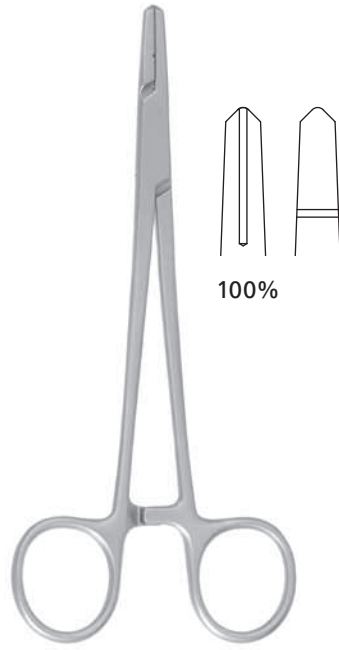

**wire holding forceps**  
cross and length serration in jaw  
TWS-1001/53 - 176mm



**chisel / osteotome set**

with 4 exchangeable blades 5/10/15/25mm width and one key

TWS-1001/54 - 200mm

**consisting of:**

TWS-1001/55 - handle

TWS-1001/56 - key / screw driver

TWS-1001/57 - 5mm wide blade

TWS-1001/58 - 10mm wide blade

TWS-1001/59 - 15mm wide blade

TWS-1001/60 - 25mm wide blade





TW SURGICAL

**osteotomes**



**Innomed osteotome**  
TWS-1001/61 - 4x185mm, straight



**Innomed osteotome**  
TWS-1001/62 - 6x185mm, straight



**Innomed osteotome**  
TWS-1001/63- 7x185mm, curved



**Innomed osteotome**  
TWS-1001/64 - 8x185mm, straight



**Innomed osteotome**  
TWS-1001/65 - 10x185mm, straight



**Innomed osteotome**  
TWS-1001/66 - 12x185mm, straight



**Innomed osteotome**  
TWS-1001/67 - 16x185mm, straight



**Innomed osteotome**  
TWS-1001/68 - 22x185mm, straight

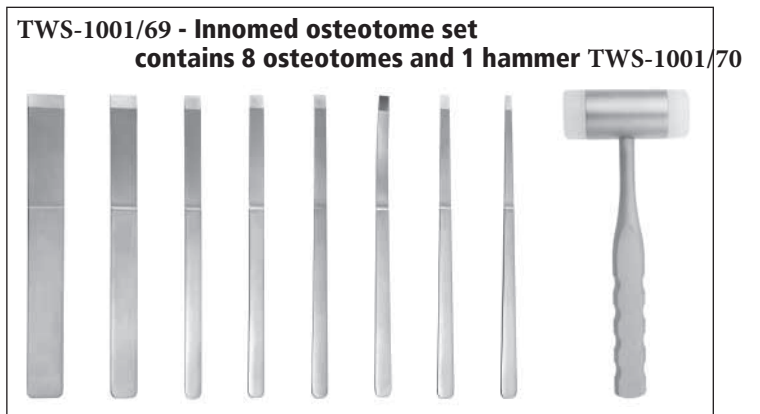



### Lambotte osteotome

TWS-1001/71 - (width 0,25") 6,35x230mm, curved  
TWS-1001/72 - (width 0,25") 6,35x230mm, straight



### Lambotte osteotome

TWS-1001/73 - (width 0,5") 12,7x230mm, curved  
TWS-1001/74 - (width 0,5") 12,7x230mm, straight



### Lambotte osteotome

TWS-1001/75 - (width 0,75") 19x230mm, curved  
TWS-1001/76 - (width 0,75") 19x230mm, straight



### Lambotte osteotome

TWS-1001/77 - (width 1,0") 25,4x230mm, curved  
TWS-1001/78 - (width 1,0") 25,4x230mm, straight



### Lambotte osteotome

TWS-1001/79 - (width 1,25") 31,75x230mm, curved  
TWS-1001/80 - (width 1,25") 31,75x230mm, straight



### Lambotte osteotome

TWS-1001/81 - (width 1,50") 38,10x230mm, curved  
TWS-1001/82 - (width 1,50") 38,10x230mm, straight



TW SURGICAL

spatula



**Davis malleable brain spatula**

TWS-1001/83 - 178mm length, 6,4mm width



**Davis malleable brain spatula**

TWS-1001/84 - 178mm length, 9,5mm width



**Davis malleable brain spatula**

TWS-1001/85 - 178mm length, 12,7mm width



**Davis malleable brain spatula**

TWS-1001/86 - 178mm length, 15,9mm width



**Davis malleable brain spatula**

TWS-1001/87 - 178mm length, 19,1mm width



**Davis malleable brain spatula**

TWS-1001/88 - 178mm length, 25,4mm width



**Davis malleable brain spatula**

TWS-1001/89 - 178mm length, 31,8mm width



**Davis malleable brain spatula**

TWS-1001/90 - 178mm length, 38,0mm width



**Heifetz brain spatula**

155mm length, blackened spatula working length: 100mm

TWS-1001/91 - 6,4mm width

TWS-1001/92 - 9,5mm width

TWS-1001/93 - 12,7mm width

TWS-1001/94 - 15,9mm width

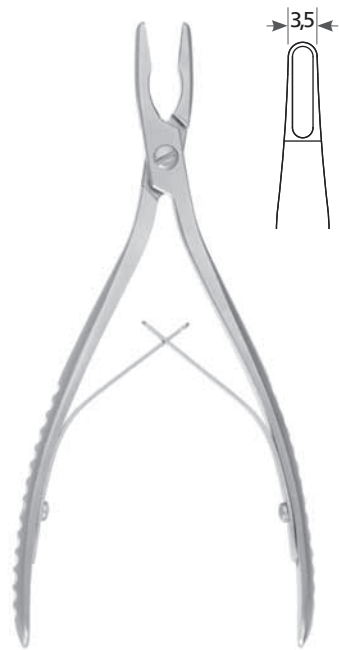

**Lempert bone rongeur**  
TWS-1001/95 - 160 / 3,5 mm

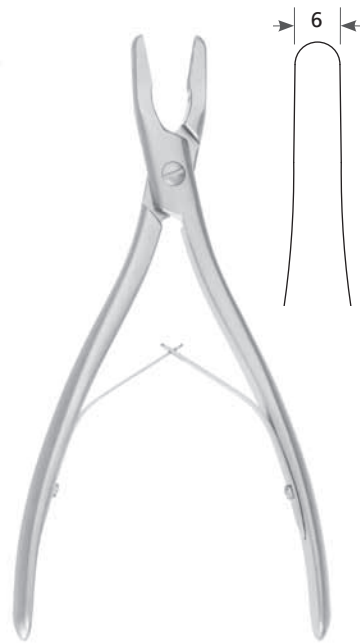

**Adson cranial rongeur**  
TWS-1001/96 - 210 / 6 mm



**bone nibbler**  
Koelbel tenectomy rongeur  
strongly curved  
TWS-1001/97 - 180 / 2,5mm



**bone nibbler**  
bone nibbling rongeur slightly curved  
TWS-1001/98 - 190 / 5,0mm

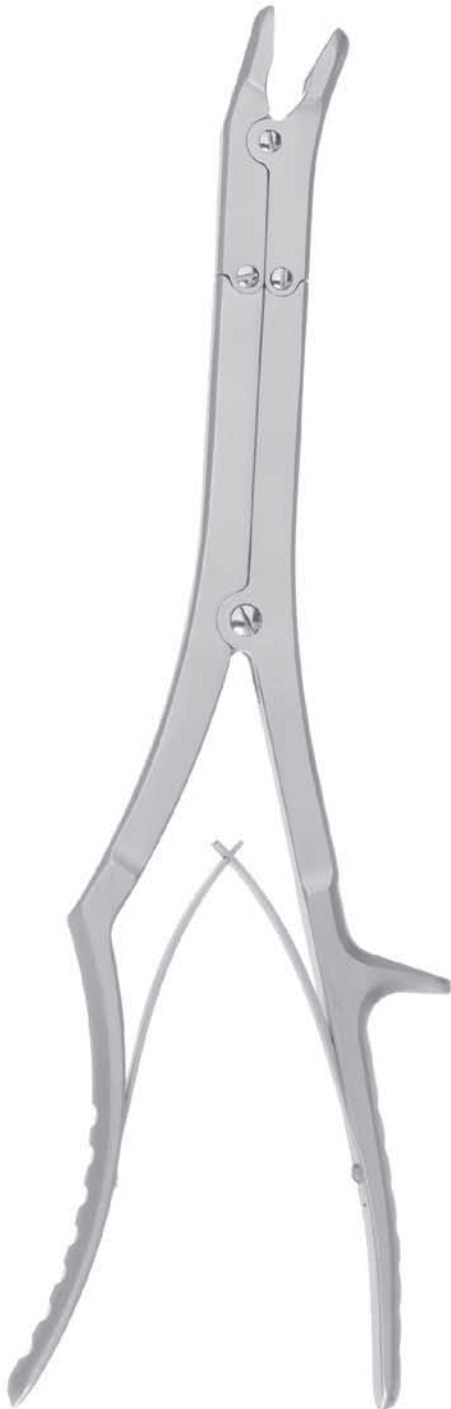

**bone rongeur double action** jaw  
without teeth  
TWS-1001/99 - 360 / 5mm  
TWS-1001/100 - 360 / 8mm  
TWS-1001/101 - 360 / 12mm

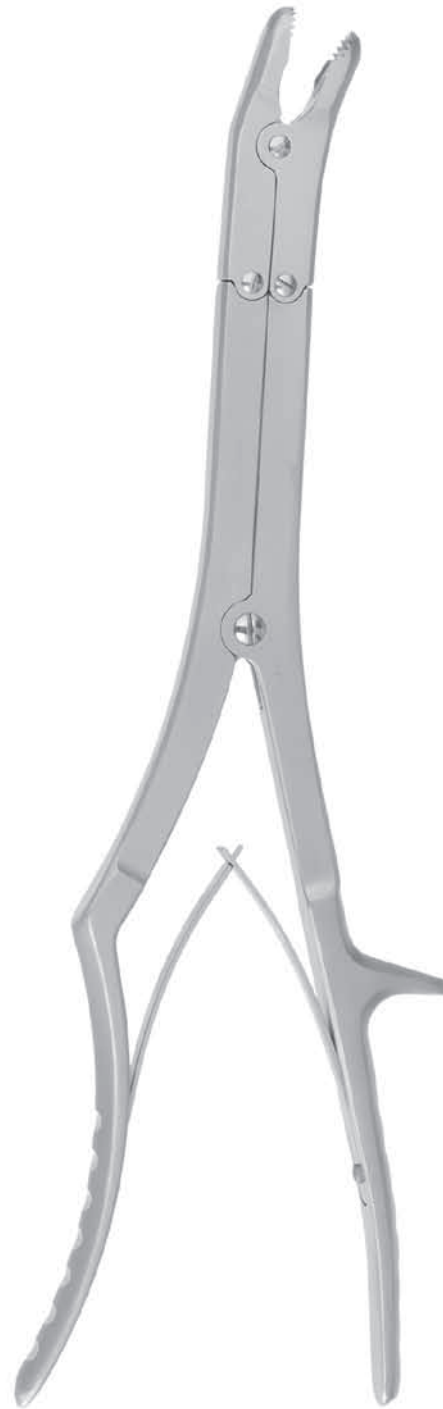

**bone rongeur double action** jaw with  
teeth  
TWS-1001/102 - 360 / 8mm, 7 teeth  
TWS-1001/103 - 360 / 12mm, 11 teeth

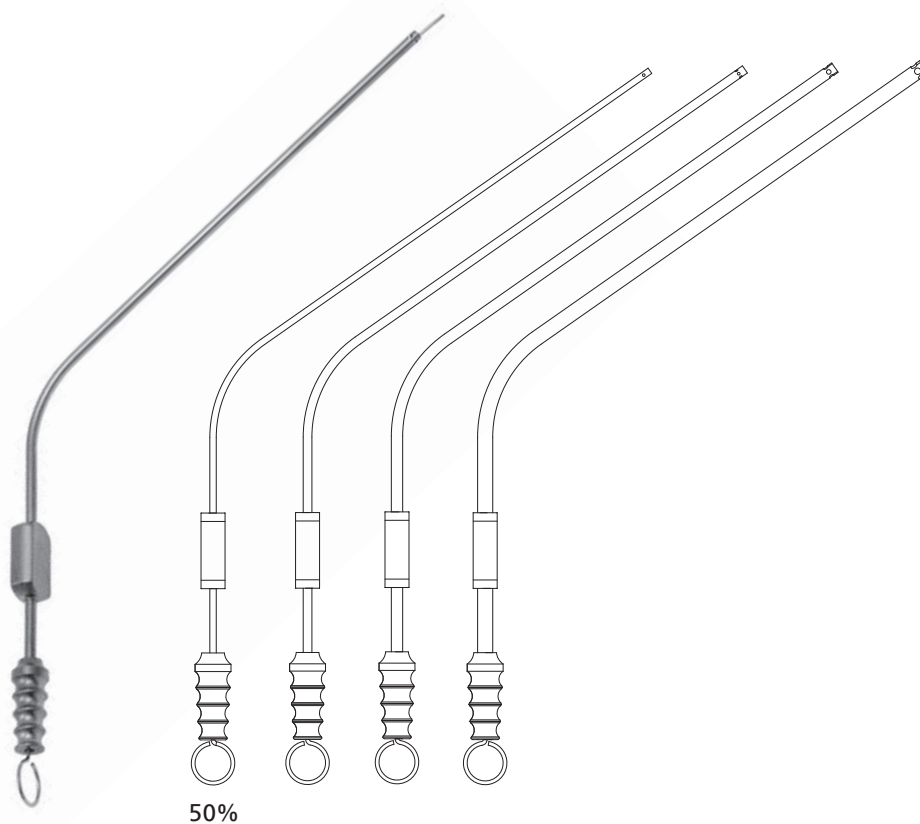

## McCulloch

suction tubes, working length 125mm, 55°

TWS-1001/104 - 1,7 mm = 5 FR

TWS-1001/105 - 2,3mm = 7 FR

TWS-1001/106 - 3,0mm = 9 FR

TWS-1001/107 - 4,0mm = 12FR

- A**  
 Adson cranial rongeur **16**  
 Alar Converse retractor **3**  
 Approximator bulldog **3**  
 Awl  
     Penetrating awl **8**  
     Percussion awl **8**
- B**  
 Bankart perforating forceps **9**  
 Blade changing forceps **5**  
 Blades, Koelbel **5**  
 Bone holding forceps **9**  
 Bone nibbler **16**  
 Bone reposition forceps **9**  
 Bone rongeur double action **17**  
 Bone spreader **3**
- C**  
 Chisel -> Osteotome  
 Crochet hook **8**
- D**  
 Davis malleable brain spatula **15**
- E**  
 Elevators **3, 7**
- F**  
 Fukuda head retractor **6**
- H**  
 Hays phalangen elevator **3**  
 Heifetz brain spatula **15**  
 Humerus head retractor **6**
- I**  
 Innomed osteotome **13**
- K**  
 Karmody spring wire retractor **3**  
 Knee instruments  
     Mastin muscle clamp **10**  
     Walton meniscus clamp **10**  
 Koelbel blades **5**  
 Koelbel spreader **5**
- L**  
 Lambotte osteotome **14**  
 lamina spreader **3**  
 Lempert bone rongeur **16**  
 Lever, Skid **7**
- M**  
 Mallet **7**  
 Mastin muscle clamp **10**  
 McCulloch suction tubes **18**
- N**  
 Needle holder  
     Neivert TC needle holder **12**
- O**  
 Osteotome  
     set with exchangeable blades **12**  
     Innomed osteotome **13**  
     Lambotte osteotome **14**
- P**  
 Penetrating awl **8**  
 Penetrating gouge **8**  
 Percussion awl **8**
- R**  
 Reposition forceps for bones **9**  
 Retractors  
     Alar Converse retractor **3**  
     Fukuda head retractor **6**  
     Humerus head retractor **6**  
     Karmody spring wire retractor **3**  
     Koelbel spreader **5**  
     Richardson hand-held retractor **6**  
     Spring wire retractor **3**  
 Richardson hand-held retractor **6**  
 Rongeur / Nibbler  
     Adson cranial rongeur **16**  
     Bone nibbler **16**  
     Bone rongeur double action **17**  
     Lempert bone rongeur **16**
- S**  
 Shoulder  
     Bankart perforating forceps **9**  
     Blade changing forceps **5**  
     Bone reposition forceps **9**  
     Crochet hook **8**  
     Elevators **7**  
     Fukuda head retractor **6**  
     Humerus head retractor **6**  
     Koelbel blades **5**  
     Koelbel spreader **5**  
     Mallet **7**  
     Penetrating awl **8**  
     Penetrating gouge **8**  
     percussion awl **8**  
     Richardson hand-held retractor **6**  
     Skid lever **7**  
     Suture passer **8**  
 Skid lever **7**  
 Spatula  
     Davis malleable brain spatula **15, 19**  
     Heifetz brain spatula **15, 19**  
 Spring wire retractor **3**  
 Suction tubes, McCulloch **18**  
 Suture passer **8**
- T**  
 Tendon seizing forceps **11**
- W**  
 Walton meniscus clamp **10**  
 Wire holding forceps **12**