



TW
Surgical

PLASTIC SURGERY



**UK
CA CE**



TW Surgical

Treasure Wright (U.K.) Ltd.



www.twrightmedical.com



info@twrightmedical.com



TW Surgical

AREOLA MARKERS



GROSSMANN AREOLA MARKER

Item Code	Description
TWS 84-3056/81	40MM,44MM,48MM, 52MM



FREEMAN AREOLA MARKER

Item Code	Description
TWS 84-3056/82	2 SIZES, 34MM / 36MM
TWS 84-3056/83	2 SIZES, 38MM / 42MM
TWS 84-3056/84	2 SIZES, 42MM / 45MM
TWS 84-3056/85	2 SIZES, 45MM / 50MM



FREEMAN AREOLA MARKER

Item Code	Description
TWS 84-3056/86	34MM
TWS 84-3056/87	36MM
TWS 84-3056/88	38MM
TWS 84-3056/89	42MM
TWS 84-3056/90	45MM
TWS 84-3056/91	50MM



STAINLESS STEEL

FREEMAN AREOLA MARKER

Item Code	Description
TWS 84-3056/92	38 MM
TWS 84-3056/93	42 MM
TWS 84-3056/94	50 MM
TWS 84-3056/95	45 MM
TWS 84-3056/96	34 MM
TWS 84-3056/97	36 MM



SOLZ AREOLA MARKER

Item Code	Description
TWS 84-3056/98	BLUNT, 36MM DIAMETER
TWS 84-3056/99	BLUNT, 40MM DIAMETER
TWS 84-3057/00	BLUNT, 42MM DIAMETER
TWS 84-3057/01	BLUNT, 45MM DIAMETER

BREAST RETRACTORS



TW Surgical



MARX BREAST RETRACTOR

Item Code	Description
TWS 84-3057/02	27CM, 125 X 30MM
TWS 84-3057/03	27CM, 140 X 30MM



FERRIERA STYLE RETRACTOR

Size	With Light Guide & Suction	With Light Guide	Retractor Only	Suction Only
70 X 16 mm	TWS 84-3057/04	TWS 84-3057/19	TWS 84-3057/34	TWS 84-3057/49
80 X 16 mm	TWS 84-3057/05	TWS 84-3057/20	TWS 84-3057/35	TWS 84-3057/50
90 X 27 mm	TWS 84-3057/06	TWS 84-3057/21	TWS 84-3057/36	TWS 84-3057/51
110 X 25 mm	TWS 84-3057/07	TWS 84-3057/22	TWS 84-3057/37	TWS 84-3057/52
120 X 25 mm	TWS 84-3057/08	TWS 84-3057/23	TWS 84-3057/38	TWS 84-3057/53
130 X 16 mm	TWS 84-3057/09	TWS 84-3057/24	TWS 84-3057/39	TWS 84-3057/54
130 X 25 mm	TWS 84-3057/10	TWS 84-3057/25	TWS 84-3057/40	TWS 84-3057/55
150 X 25 mm	TWS 84-3057/11	TWS 84-3057/26	TWS 84-3057/41	TWS 84-3057/56
150 X 30 mm	TWS 84-3057/12	TWS 84-3057/27	TWS 84-3057/42	TWS 84-3057/57
150 X 36 mm	TWS 84-3057/13	TWS 84-3057/28	TWS 84-3057/43	TWS 84-3057/58
180 X 16 mm	TWS 84-3057/14	TWS 84-3057/29	TWS 84-3057/44	TWS 84-3057/59
180 X 25 mm	TWS 84-3057/15	TWS 84-3057/30	TWS 84-3057/45	TWS 84-3057/60
190 X 25 mm	TWS 84-3057/16	TWS 84-3057/31	TWS 84-3057/46	TWS 84-3057/61
190 X 36 mm	TWS 84-3057/17	TWS 84-3057/32	TWS 84-3057/47	TWS 84-3057/62
220 X 27 mm	TWS 84-3057/18	TWS 84-3057/33	TWS 84-3057/48	TWS 84-3057/63

Treasure Wright (U.K.) Ltd.

128-160 City Road, London, EC1V 2NX, United Kingdom
info@twrightmedical.com



TW Surgical

BREAST RETRACTORS

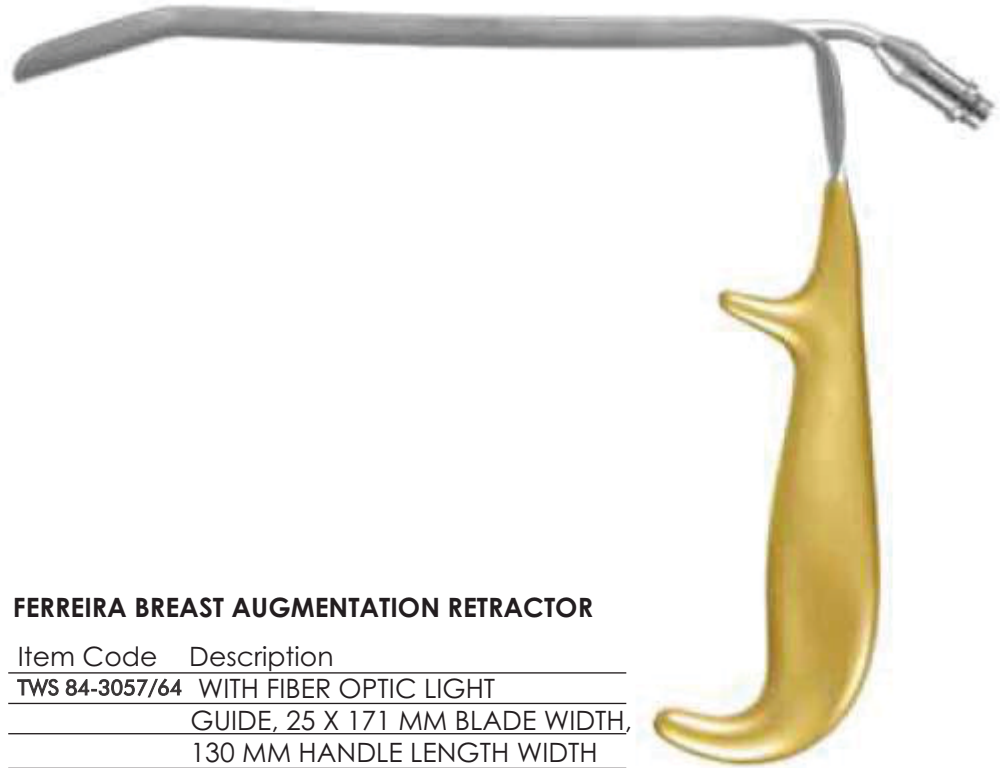

FERREIRA BREAST AUGMENTATION RETRACTOR

Item Code	Description
TWS 84-3057/64	WITH FIBER OPTIC LIGHT GUIDE, 25 X 171 MM BLADE WIDTH, 130 MM HANDLE LENGTH WIDTH



TEBBETTS RETRACTORS

Size	With Light Guide & Suction	With Light Guide	Retractor Only	Suction Only
70 X 16 mm	TWS 84-3057/65	TWS 84-3057/80	TWS 84-3057/95	TWS 84-3058/10
80 X 16 mm	TWS 84-3057/66	TWS 84-3057/81	TWS 84-3057/96	TWS 84-3058/11
90 X 27 mm	TWS 84-3057/67	TWS 84-3057/82	TWS 84-3057/97	TWS 84-3058/12
110 X 25 mm	TWS 84-3057/68	TWS 84-3057/83	TWS 84-3057/98	TWS 84-3058/13
120 X 25 mm	TWS 84-3057/69	TWS 84-3057/84	TWS 84-3057/99	TWS 84-3058/14
130 X 16 mm	TWS 84-3057/70	TWS 84-3057/85	TWS 84-3058/00	TWS 84-3058/15
130 X 25 mm	TWS 84-3057/71	TWS 84-3057/86	TWS 84-3058/01	TWS 84-3058/16
150 X 25 mm	TWS 84-3057/72	TWS 84-3057/87	TWS 84-3058/02	TWS 84-3058/17
150 X 30 mm	TWS 84-3057/73	TWS 84-3057/88	TWS 84-3058/03	TWS 84-3058/18
150 X 36 mm	TWS 84-3057/74	TWS 84-3057/89	TWS 84-3058/04	TWS 84-3058/19
180 X 16 mm	TWS 84-3057/75	TWS 84-3057/90	TWS 84-3058/05	TWS 84-3058/20
180 X 25 mm	TWS 84-3057/76	TWS 84-3057/91	TWS 84-3058/06	TWS 84-3058/21
190 X 25 mm	TWS 84-3057/77	TWS 84-3057/92	TWS 84-3058/07	TWS 84-3058/22
190 X 36 mm	TWS 84-3057/78	TWS 84-3057/93	TWS 84-3058/08	TWS 84-3058/23
220 X 27 mm	TWS 84-3057/79	TWS 84-3057/94	TWS 84-3058/09	TWS 84-3058/24

Treasure Wright (U.K.) Ltd.

128-160 City Road, London, EC1V 2NX, United Kingdom
info@twrightmedical.com

BREAST RETRACTORS



TW Surgical



TEBBETTS RETRACTOR, With Double Handle and Teeth at tip

Size	With Light Guide & Suction	With Light Guide	Retractor Only	Suction Only
70 X 16 mm	TWS 84-3058/25	TWS 84-3058/40	TWS 84-3058/55	TWS 84-3058/70
80 X 16 mm	TWS 84-3058/26	TWS 84-3058/41	TWS 84-3058/56	TWS 84-3058/71
90 X 27 mm	TWS 84-3058/27	TWS 84-3058/42	TWS 84-3058/57	TWS 84-3058/72
110 X 25 mm	TWS 84-3058/28	TWS 84-3058/43	TWS 84-3058/58	TWS 84-3058/73
120 X 25 mm	TWS 84-3058/29	TWS 84-3058/44	TWS 84-3058/59	TWS 84-3058/74
130 X 16 mm	TWS 84-3058/30	TWS 84-3058/45	TWS 84-3058/60	TWS 84-3058/75
130 X 25 mm	TWS 84-3058/31	TWS 84-3058/46	TWS 84-3058/61	TWS 84-3058/76
150 X 25 mm	TWS 84-3058/32	TWS 84-3058/47	TWS 84-3058/62	TWS 84-3058/77
150 X 30 mm	TWS 84-3058/33	TWS 84-3058/48	TWS 84-3058/63	TWS 84-3058/78
150 X 36 mm	TWS 84-3058/34	TWS 84-3058/49	TWS 84-3058/64	TWS 84-3058/79
180 X 16 mm	TWS 84-3058/35	TWS 84-3058/50	TWS 84-3058/65	TWS 84-3058/80
180 X 25 mm	TWS 84-3058/36	TWS 84-3058/51	TWS 84-3058/66	TWS 84-3058/81
190 X 25 mm	TWS 84-3058/37	TWS 84-3058/52	TWS 84-3058/67	TWS 84-3058/82
190 X 36 mm	TWS 84-3058/38	TWS 84-3058/53	TWS 84-3058/68	TWS 84-3058/83
220 X 27 mm	TWS 84-3058/39	TWS 84-3058/54	TWS 84-3058/69	TWS 84-3058/84

Treasure Wright (U.K.) Ltd.

128-160 City Road, London, EC1V 2NX, United Kingdom
info@twrightmedical.com



TW Surgical

BREAST RETRACTORS

TEBBETTS RETRACTOR, Insulated Blade with Teeth

Size	With Light Guide & Suction	With Light Guide	Retractor Only	Suction Only
70 X 16 mm	TWS 84-3058/85	TWS 84-3059/00	TWS 84-3059/15	TWS 84-3059/30
80 X 16 mm	TWS 84-3058/86	TWS 84-3059/01	TWS 84-3059/16	TWS 84-3059/31
90 X 27 mm	TWS 84-3058/87	TWS 84-3059/02	TWS 84-3059/17	TWS 84-3059/32
110 X 25 mm	TWS 84-3058/88	TWS 84-3059/03	TWS 84-3059/18	TWS 84-3059/33
120 X 25 mm	TWS 84-3058/89	TWS 84-3059/04	TWS 84-3059/19	TWS 84-3059/34
130 X 16 mm	TWS 84-3058/90	TWS 84-3059/05	TWS 84-3059/20	TWS 84-3059/35
130 X 25 mm	TWS 84-3058/91	TWS 84-3059/06	TWS 84-3059/21	TWS 84-3059/36
150 X 25 mm	TWS 84-3058/92	TWS 84-3059/07	TWS 84-3059/22	TWS 84-3059/37
150 X 30 mm	TWS 84-3058/93	TWS 84-3059/08	TWS 84-3059/23	TWS 84-3059/38
150 X 36 mm	TWS 84-3058/94	TWS 84-3059/09	TWS 84-3059/24	TWS 84-3059/39
180 X 16 mm	TWS 84-3058/95	TWS 84-3059/10	TWS 84-3059/25	TWS 84-3059/40
180 X 25 mm	TWS 84-3058/96	TWS 84-3059/11	TWS 84-3059/26	TWS 84-3059/41
190 X 25 mm	TWS 84-3058/97	TWS 84-3059/12	TWS 84-3059/27	TWS 84-3059/42
190 X 36 mm	TWS 84-3058/98	TWS 84-3059/13	TWS 84-3059/28	TWS 84-3059/43
220 X 27 mm	TWS 84-3058/99	TWS 84-3059/14	TWS 84-3059/29	TWS 84-3059/44



Tebbetts Breast Augmentation Fiber Optic Retractor, Insulated Blade With Smooth End

Size	With Light Guide & Suction	With Light Guide	Retractor Only	Suction Only
70 X 16 mm	TWS 84-3059/45	TWS 84-3059/60	TWS 84-3059/75	TWS 84-3059/90
80 X 16 mm	TWS 84-3059/46	TWS 84-3059/61	TWS 84-3059/76	TWS 84-3059/91
90 X 27 mm	TWS 84-3059/47	TWS 84-3059/62	TWS 84-3059/77	TWS 84-3059/92
110 X 25 mm	TWS 84-3059/48	TWS 84-3059/63	TWS 84-3059/78	TWS 84-3059/93
120 X 25 mm	TWS 84-3059/49	TWS 84-3059/64	TWS 84-3059/79	TWS 84-3059/94
130 X 16 mm	TWS 84-3059/50	TWS 84-3059/65	TWS 84-3059/80	TWS 84-3059/95
130 X 25 mm	TWS 84-3059/51	TWS 84-3059/66	TWS 84-3059/81	TWS 84-3059/96
150 X 25 mm	TWS 84-3059/52	TWS 84-3059/67	TWS 84-3059/82	TWS 84-3059/97
150 X 30 mm	TWS 84-3059/53	TWS 84-3059/68	TWS 84-3059/83	TWS 84-3059/98
150 X 36 mm	TWS 84-3059/54	TWS 84-3059/69	TWS 84-3059/84	TWS 84-3059/99
180 X 16 mm	TWS 84-3059/55	TWS 84-3059/70	TWS 84-3059/85	TWS 84-3060/00
180 X 25 mm	TWS 84-3059/56	TWS 84-3059/71	TWS 84-3059/86	TWS 84-3060/01
190 X 25 mm	TWS 84-3059/57	TWS 84-3059/72	TWS 84-3059/87	TWS 84-3060/02
190 X 36 mm	TWS 84-3059/58	TWS 84-3059/73	TWS 84-3059/88	TWS 84-3060/03
220 X 27 mm	TWS 84-3059/59	TWS 84-3059/74	TWS 84-3059/89	TWS 84-3060/04



Treasure Wright (U.K.) Ltd.

128-160 City Road, London, EC1V 2NX, United Kingdom
info@twrightmedical.com

BREAST RETRACTORS



TW Surgical

Tebbetts Breast Augmentation Fiber Optic Retractor, With Double Handle and Smooth End

Size	With Light Guide & Suction	With Light Guide	Retractor Only	Suction Only
70 X 16 mm	TWS 84-3060/05	TWS 84-3060/20	TWS 84-3060/35	TWS 84-3060/50
80 X 16 mm	TWS 84-3060/06	TWS 84-3060/21	TWS 84-3060/36	TWS 84-3060/51
90 X 27 mm	TWS 84-3060/07	TWS 84-3060/22	TWS 84-3060/37	TWS 84-3060/52
110 X 25 mm	TWS 84-3060/08	TWS 84-3060/23	TWS 84-3060/38	TWS 84-3060/53
120 X 25 mm	TWS 84-3060/09	TWS 84-3060/24	TWS 84-3060/39	TWS 84-3060/54
130 X 16 mm	TWS 84-3060/10	TWS 84-3060/25	TWS 84-3060/40	TWS 84-3060/55
130 X 25 mm	TWS 84-3060/11	TWS 84-3060/26	TWS 84-3060/41	TWS 84-3060/56
150 X 25 mm	TWS 84-3060/12	TWS 84-3060/27	TWS 84-3060/42	TWS 84-3060/57
150 X 30 mm	TWS 84-3060/13	TWS 84-3060/28	TWS 84-3060/43	TWS 84-3060/58
150 X 36 mm	TWS 84-3060/14	TWS 84-3060/29	TWS 84-3060/44	TWS 84-3060/59
180 X 16 mm	TWS 84-3060/15	TWS 84-3060/30	TWS 84-3060/45	TWS 84-3060/60
180 X 25 mm	TWS 84-3060/16	TWS 84-3060/31	TWS 84-3060/46	TWS 84-3060/61
190 X 25 mm	TWS 84-3060/17	TWS 84-3060/32	TWS 84-3060/47	TWS 84-3060/62
190 X 36 mm	TWS 84-3060/18	TWS 84-3060/33	TWS 84-3060/48	TWS 84-3060/63
220 X 27 mm	TWS 84-3060/19	TWS 84-3060/34	TWS 84-3060/49	TWS 84-3060/64





TW Surgical

BREAST RETRACTORS



Sculpo Breast Retractors

Item Code	Description
<u>TWS 84-3060/65</u>	<u>180 X 25mm, Blade Size, With 5mm Endoscopic Scope Sheath</u>
<u>TWS 84-3060/66</u>	<u>180 X 25mm, Blade Size, With 10mm Endoscopic Scope Sheath</u>



Ring breast retractor

Item Code	Description
<u>TWS 84-3060/67</u>	<u>with fiber optic illumination and irrigation tube</u>

Treasure Wright (U.K.) Ltd.

128-160 City Road, London, EC1V 2NX, United Kingdom
info@twrightmedical.com

BREAST RETRACTORS



TW Surgical



BIGGS MAMMAPLASTY RETRACTOR

Item Code	Description
TWS 84-3060/68	WITH FIBER OPTIC LIGHT GUIDE 5.0 CM BLADE WIDTH, 20 CM LENGTH



BIGGS MAMMAPLASTY RETRACTOR,

Item Code	Description
TWS 84-3060/69	3 CM BLADE WIDTH, NARROW, (171 MM) LENGTH



TW Surgical

BREAST RETRACTORS

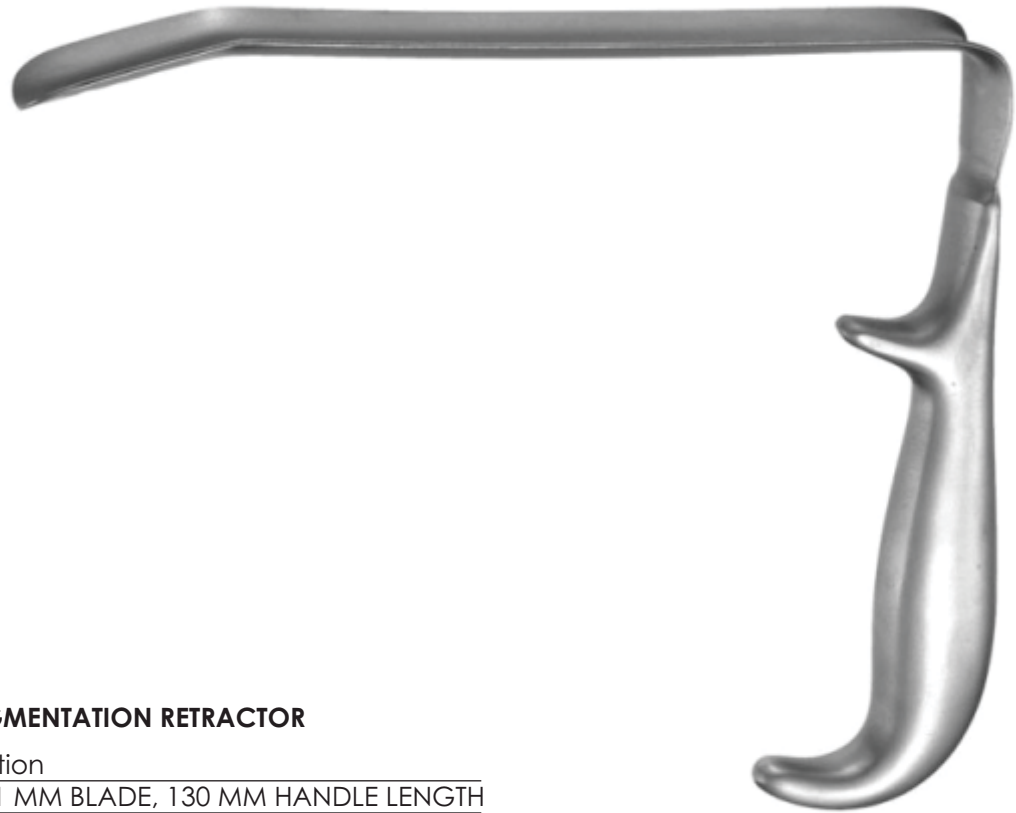

FERREIRA BREAST AUGMENTATION RETRACTOR

Item Code	Description
TWS 84-3060/70	25 X 171 MM BLADE, 130 MM HANDLE LENGTH



BIGGS MAMMAPLASTY RETRACTOR

Item Code	Description
TWS 84-3060/71	WITH FIBER OPTIC LIGHT GUIDE, NARROW, 3.0 CM BLADE WIDTH, 15 CM LENGTH

Treasure Wright (U.K.) Ltd.

128-160 City Road, London, EC1V 2NX, United Kingdom
info@twrightmedical.com

BREAST RETRACTORS



TW Surgical



BIGGS MAMMAPLASTY RETRACTOR

Item Code	Description
TWS 84-3060/72	50 MM WIDTH, STANDARD, 20 CM LENGTH



BREAST RETRACTOR

Item Code	Description
TWS 84-3060/73	DOUBLE ENDED, (31 CM), BLADES 22MM X 55MM AND 38MM X 70MM
TWS 84-3060/74	DOUBLE ENDED, (24 CM), BLADES 22MM X 55MM AND 38MM X 70MM



BIGGS MAMMAPLASTY RETRACTORS

Item Code	Description
TWS 84-3060/75	30MM, WITH FIBER OPTIC LIGHT GUIDE
TWS 84-3060/76	50MM, WITH FIBER OPTIC LIGHT GUIDE
TWS 84-3060/77	30MM, WITH FIBER OPTIC LIGHT GUIDE AND SUCTION
TWS 84-3060/78	50MM, WITH FIBER OPTIC LIGHT GUIDE AND SUCTION

BREAST RETRACTORS



WIEDER BREAST AND FACIAL RETRACTOR / TONGUE DEPRESSOR, WITH FIBER OPTIC LIGHT GUIDE

Item Code	Description
TWS 84-3060/79	SERRATED, (14 CM), 28MM
TWS 84-3060/81	SERRATED, (14 CM), 38MM
TWS 84-3060/80	SERRATED, (15 CM), 45MM



BREAST SPATULA

Item Code	Description
TWS 84-3060/82	WITH HANDLE 31.5 CM, 25MM X 18 CM BLADE, SERRATED TIP, SEMI MALLABLE



WIEDER BREAST AND FACIAL RETRACTOR / TONGUE DEPRESSOR

Item Code	Description
TWS 84-3060/83	SERRATED, (14 CM), 28MM
TWS 84-3060/84	SERRATED, (14 CM), 38MM
TWS 84-3060/85	SERRATED, (15 CM), 45MM



TW Surgical

BREAST DISSECTORS & ELEVATORS



MACCOLLUM DINGMAN BREAST DISSECTOR

Item Code	Description
TWS 84-3060/86	31.5 CM
TWS 84-3060/87	41 CM



MACCOLLUM DINGMAN SUBMAMMARY DISSECTOR

Item Code	Description
TWS 84-3060/88	30 CM



MACCOLLUM DINGMAN BREAST DISSECTOR

Item Code	Description
TWS 84-3060/89	1½" (38 MM) WIDTH, 17½" (432 MM) LENGTH



BREAST DISSECTOR

Item Code	Description
TWS 84-3060/90	SPATULATED BLADE, 33CM
TWS 84-3060/91	SPATULATED BLADE, 42CM



BREAST DISSECTOR

Item Code	Description
TWS 84-3060/92	OVAL SPATULATED BLADE, 33CM
TWS 84-3060/93	OVAL SPATULATED BLADE, 42CM

Treasure Wright (U.K.) Ltd.

128-160 City Road, London, EC1V 2NX, United Kingdom
info@twrightmedical.com

BREAST DISSECTOR & ELEVATORS



TW Surgical

BREAST DISSECTOR

Item Code	Description
<u>TWS 84-3060/94</u>	<u>ANGULATED BLADE, 33CM</u>
<u>TWS 84-3060/95</u>	<u>ANGULATED BLADE, 42CM</u>



REYNOLDS TRANSAUXILLARY BREAST DISSECTOR

Item Code	Description
<u>TWS 84-3060/96</u>	<u>FENESTRATED, 33CM</u>
<u>TWS 84-3060/97</u>	<u>FENESTRATED, 40CM</u>



SILVERSTEIN BREAST DISSECTOR

Item Code	Description
<u>TWS 84-3060/98</u>	<u>14" (356 MM) LENGTH</u>



SPATULA BREAST RETRACTOR / DISSECTOR

Item Code	Description
<u>TWS 84-3060/99</u>	<u>SERRATED, 12½", SEMI MALLEABLE</u>



PENN BREAST DISSECTOR

Item Code	Description
<u>TWS 84-3061/00</u>	<u>STRAIGHT, 1" (25 MM) WIDTH, 12¾" (324 MM) LENGTH</u>

Treasure Wright (U.K.) Ltd.

128-160 City Road, London, EC1V 2NX, United Kingdom
info@twrightmedical.com



TW Surgical

BREAST DISSECTORS & ELEVATORS



MCINNIS POLYCURETTE BREAST INSTRUMENT

Item Code	Description
TWS 84-3061/01	11 ³ / ₄ " (300 MM) WIDTH, 12 ¹ / ₂ " (318 MM) LENGTH



JACOBS TRANSAXILLARY DISSECTOR

Item Code	Description
TWS 84-3061/02	CURVED SHAFT CHISEL EDGE 17" (432 mm) WIDTH 1/2" (13mm)



WIESLANDER TRANSAXILLARY BREAST DISSECTOR

Item Code	Description
TWS 84-3061/03	LENGTH 18 1/8" (460mm) WIDTH 1" (25mm)
TWS 84-3061/04	LENGTH 17" (432mm) WIDTH 1-3/8" (35mm)



REYNOLDS TRANSAXILLARY BREAST DISSECTOR

Item Code	Description
TWS 84-3061/05	15 3/4" (400mm) 1 1/2" (38mm)



TROCER BREAST TUBE

Item Code	Description
TWS 84-3061/06	14" (356 MM), LARGE, 17.3 MM ID, 19.0 MM OD
TWS 84-3061/07	13 1/2" (343MM), SMALL, 14 MM ID, 16 MM OD

BREAST DISSECTOR & ELEVATORS



TW Surgical



SOLZ ATRAUMATIC BREAST DISSECTOR

Item Code	Description
TWS 84-3061/08	34CM
TWS 84-3061/09	37CM



SOLZ BREAST HOOK DISSECTOR

Item Code	Description
TWS 84-3061/10	36CM



AGRIS DINGMAN BREAST DISSECTOR

Item Code	Description
TWS 84-3061/11	SET OF 2, LEFT AND RIGHT, 36CM



ICONOCLAST

Item Code	Description
TWS 84-3061/12	LARGE, 11½" (292 MM) LENGTH, 5¾" (146 MM) BLADE
TWS 84-3061/13	SMALL, 8¾" (222 MM) LENGTH, 3¼" (83 MM) BLADE



<u>Item Code</u>	<u>Description</u>
TWS 84-3061/14	BREAST ELEVATOR FOR MAMMARY PLASTY

DISSECTOR & ELEVATORS



TW Surgical

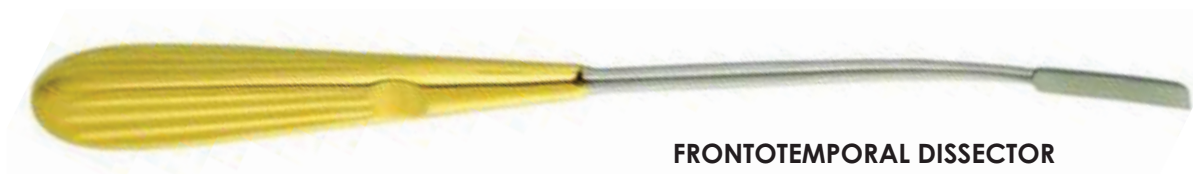

FRONTOTEMPORAL DISSECTOR

Item Code Description

TWS 84-3061/15 9" (22.5 CM), 5MM TIP, SLIGHTLY CURVED

TWS 84-3061/16 9" (23 CM), 7MM TIP, SLIGHTLY CURVED

TWS 84-3061/17 9" (23 CM), 10MM TIP, SLIGHTLY CURVED



FLAP DISSECTOR

Item Code Description

TWS 84-3061/18 9½" (23.5 CM), 5MM TIP, STRAIGHT



TEMPORAL T DISSECTOR

Item Code Description

03-023-001 9½" (23.5 CM), 12MM TIP, STRAIGHT



FRONTOGLABELLAR DISSECTOR

Item Code Description

TWS 84-3061/19 10½" (26.5 CM), 7MM TIP, S SHAPED

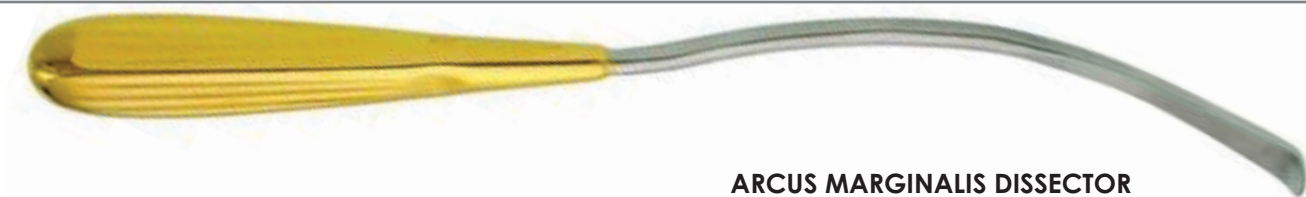

ARCUS MARGINALIS DISSECTOR

Item Code Description

TWS 84-3061/20 9 3/4" (24 CM), 10MM TIP, S SHAPED



TW Surgical

DISSECTORS & ELEVATORS



MIDFACE FACIAL DISSECTOR,

Item Code	Description
TWS 84-3061/21	9 ³ / ₄ " (24 CM), MULTIPLE CURVES, 12MM WIDE TIP



ORBITAL RIM DISSECTOR

Item Code	Description
TWS 84-3061/22	9" (22.5 CM), SLIGHTLY CURVED



TRANSORAL DISSECTOR

Item Code	Description
TWS 84-3061/23	9 ³ / ₄ " (23.5 CM), CURVED TIP



ZYGOMATIC ARCH ELEVATOR

Item Code	Description
TWS 84-3061/24	8 ¹ / ₄ " (20.5 CM), STRAIGHT BLADE, 5MM



SCALP ELEVATOR

Item Code	Description
TWS 84-3061/25	9 3/4" (24 CM), 12.5MM TIP, SLIGHTLY CURVED
TWS 84-3061/26	9 3/4" (24 CM), 15MM TIP, SLIGHTLY CURVED
TWS 84-3061/27	9 3/4" (24 CM), 7MM TIP, STRAIGHT
TWS 84-3061/28	9 3/4" (24 CM), 12.5MM TIP, S SHAPED
TWS 84-3061/29	9 3/4" (24 CM), 12.5MM TIP, SLIGHTLY CURVED
TWS 84-3061/30	9 3/4" (24 CM), 7MM TIP, CURVED TIP
TWS 84-3061/31	9 3/4" (24 CM), 7MM TIP, STRONGLY CURVED
TWS 84-3061/32	9 3/4" (24 CM), 7MM TIP, SLIGHTLY CURVED

Treasure Wright (U.K.) Ltd.

128-160 City Road, London, EC1V 2NX, United Kingdom
info@twrightmedical.com



SCALP ELEVATOR WITH SUCTION

Item Code	Description
TWS 84-3061/33	9 ³ / ₄ " (24 CM), 7MM WIDE TIP, SLIGHTLY CURVED



SCALP ELEVATOR WITH SUCTION

Item Code	Description
TWS 84-3061/34	10 ¹ / ₂ " (26 CM), 8.5 MM WIDE TIP, CURVED TIP



PERIOSTEAL ELEVATOR

TWS 84-3061/35	10" (25 CM), S SHAPED
----------------	-----------------------



PERIOSTEAL SPREADER

Item Code	Description
TWS 84-3061/36	9 ³ / ₄ " (24 CM), 8MM TIP, S SHAPED



PERIOSTEAL SPREADER

Item Code	Description
TWS 84-3061/37	9 ³ / ₄ " (24 CM), 10MM WIDE BLADE, S SHAPED



TW Surgical

DISSECTORS & ELEVATORS



HALLE SEPTUM ELEVATOR

Item Code Description

TWS 84-3061/38 NARROW, 3 MM WIDTH, 7" (178 MM) LENGTH



FREER SEPTUM ELEVATOR

Item Code Description

TWS 84-3061/39 DOUBLE ENDED, SHARP / BLUNT, WIDE,
6.5 MM WIDTH, 7³/₄" (197 MM) LENGTH



HAJEK BALLENGER SEPTUM ELEVATOR

Item Code Description

TWS 84-3061/40 DOUBLE ENDED, 8.5 MM WIDTH, 7¹/₂"
(191 MM) LENGTH



FREER SEPTUM ELEVATOR

Item Code Description

TWS 84-3061/41 CURVED, DOUBLE ENDED, 5 MM
WIDTH, 7¹/₂" (191 MM) LENGTH



KILLIAN SEPTUM ELEVATOR

Item Code Description

TWS 84-3061/42 DOUBLE ENDED, 4 MM WITH 3.4 MM
TAPER, AND 4.3 MM WITH 3 MM TAPER,
7¹/₄" (184 MM) LENGTH

NAGATA AURICULAR SEPTUM

Item Code Description

TWS 84-3061/43 ELEVATOR, 16CM, BLUNT
TWS 84-3061/44 ELEVATOR, 17CM, BLUNT

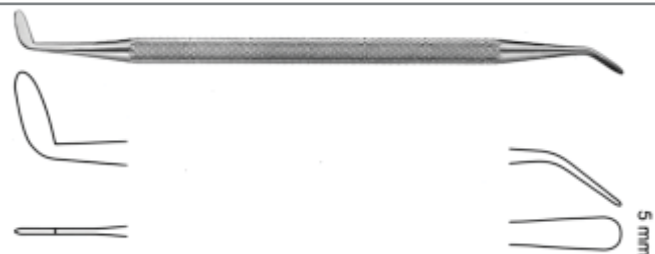

Treasure Wright (U.K.) Ltd.

128-160 City Road, London, EC1V 2NX, United Kingdom
info@twrightmedical.com



LANGENBECK BONE ELEVATOR

Item Code	Description
TWS 84-3061/45	23CM, 10MM, BLUNT, STRONG CURVE



FREER PERIOSTEAL ELEVATOR

Item Code	Description
TWS 84-3061/46	19CM, 5MM, DOUBLE ENDED, SHARP / BLUNT
TWS 84-3061/47	19CM, 6.5MM, DOUBLE ENDED, SHARP / BLUNT

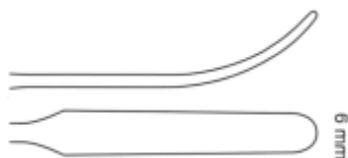

COHEN PERIOSTEAL ELEVATOR / RETRACTOR

Item Code	Description
TWS 84-3061/48	24CM, 6MM, DOUBLE ENDED, BLUNT



PENNINGTON SEPTUM ELEVATOR

Item Code	Description
TWS 84-3061/49	20CM, DOUBLE ENDED



TW Surgical

DISSECTORS & ELEVATORS

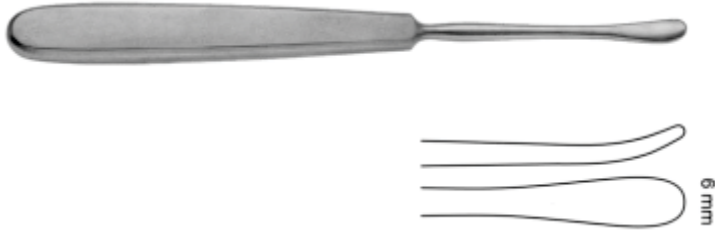

YANKAUER SEPTUM ELEVATOR

Item Code	Description
TWS 84-3061/50	18CM, 6MM, BLUNT



COTTLE PERIOSTEAL ELEVATOR

Item Code	Description
TWS 84-3061/51	18CM, 8MM, BLUNT

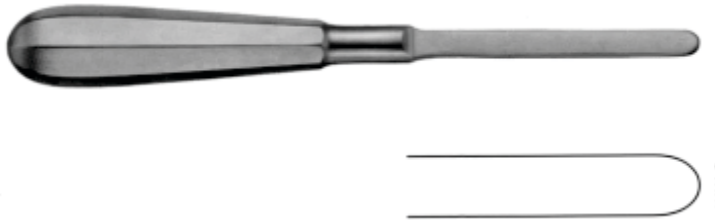

BOIES NASAL FRACTURE ELEVATOR

Item Code	Description
TWS 84-3061/52	19CM, 8MM, BLUNT



GOLDMAN SEPTUM FRACTURE ELEVATOR,

Item Code	Description
TWS 84-3061/53	17CM, 5MM, BLUNT

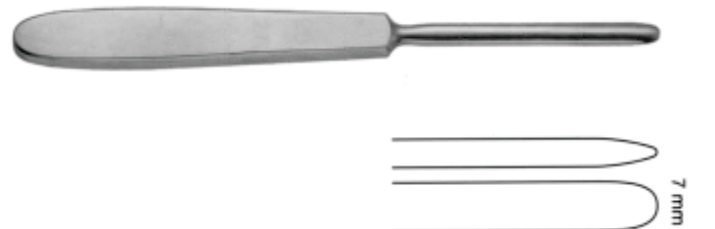

NASAL FRACTURE ELEVATOR

Item Code	Description
TWS 84-3061/54	17CM, 7MM, BLUNT

Treasure Wright (U.K.) Ltd.

128-160 City Road, London, EC1V 2NX, United Kingdom
info@twrightmedical.com

DISSECTOR & ELEVATORS



SUCTION ELEVATOR WITH GUIDE

Item Code	Description
TWS 84-3061/55	21CM, 4MM

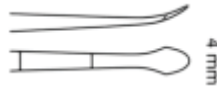
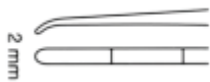

COTTLE PERIOSTEAL ELEVATOR

Item Code	Description
TWS 84-3061/56	20CM, 2/4MM, DOUBLE ENDED, FINE
TWS 84-3061/57	23CM, 3/4MM, DOUBLE ENDED

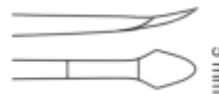

MASING SEPTUM ELEVATOR

Item Code	Description
TWS 84-3061/58	22CM, 5/5MM, DOUBLE ENDED



LANGENBECK BONE ELEVATOR

Item Code	Description
TWS 84-3061/59	20CM, 7MM, BLUNT
TWS 84-3061/60	20CM, 10MM, BLUNT



TW Surgical

DISSECTORS & ELEVATORS



HOWARTH SEPTUM ELEVATOR

Item Code Description

TWS 84-3061/61 DOUBLE ENDED, 5 MM WIDTH, 8½"
(216 MM) LENGTH



KILLIAN SEPTUM ELEVATOR

Item Code Description

TWS 84-3061/62 DOUBLE ENDED, 9" (229 MM) LENGTH,
6 MM WITH 4.5 MM TAPER AND 4.3 MM
WITH 3 MM TAPER

CHISELS & GOUGES



TW Surgical



GRADUATED CHISELS

Item Code	Description
TWS 84-3061/63	17.8CM, 3.8MM



GRADUATED CHISELS

Item Code	Description
TWS 84-3061/64	17.8CM, 3.8MM



GRADUATED CHISELS

Item Code	Description
TWS 84-3061/65	17.8CM, 7.5MM



GRADUATED CHISELS

Item Code	Description
TWS 84-3061/66	17.8CM, 7.5MM



FREER SEPTUM CHISEL

Item Code	Description
TWS 84-3061/67	15.5CM, 4MM
TWS 84-3061/68	15.5CM, 6MM



BALLENGER SEPTUM CHISEL

Item Code	Description
TWS 84-3061/69	16CM, 4MM
TWS 84-3061/70	16CM, 6MM



KILLIAN NASAL GOUGE

Item Code	Description
TWS 84-3061/71	17.5CM, 6MM



KILLIAN CLAUS NASAL GOUGE

Item Code	Description
TWS 84-3061/72	17CM, 6MM

CHISELS & GOUGES



COTTLE GUBISCH CHISEL

Item Code Description
TWS 84-3061/73 18CM, 5MM, GRADUATED, HOLLOW CUT
TWS 84-3061/74 18CM, 12MM, GRADUATED, HOLLOW CUT



COTTLE CHISEL

Item Code Description
TWS 84-3061/75 18CM, 4MM, CROSS BAR, GRADUATED
TWS 84-3061/76 18CM, 7MM, CROSS BAR, GRADUATED
TWS 84-3061/77 18CM, 9MM, CROSS BAR, GRADUATED
TWS 84-3061/78 18CM, 12MM, CROSS BAR, GRADUATED

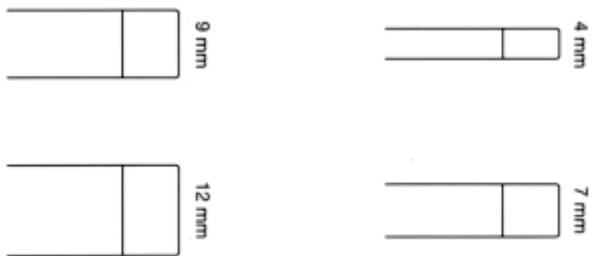

COTTLE CHISEL

Item Code Description
TWS 84-3061/79 18CM, 16MM, FISHTAIL SHAPED END, CROSSBAR,

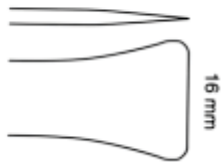

RUBIN EDGED BONE CHISEL

Item Code Description
TWS 84-3061/80 18CM, 8/12MM, T SHAPE
TWS 84-3061/81 18CM, 10/14MM, T SHAPE
TWS 84-3061/82 18CM, 12/16MM, T SHAPE

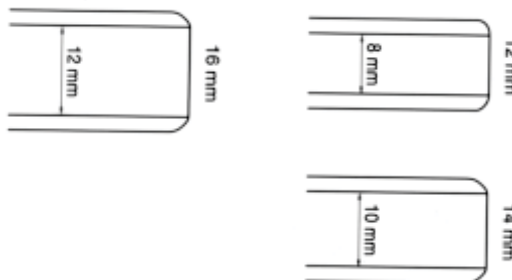



TW Surgical

CHISELS & GOUGES

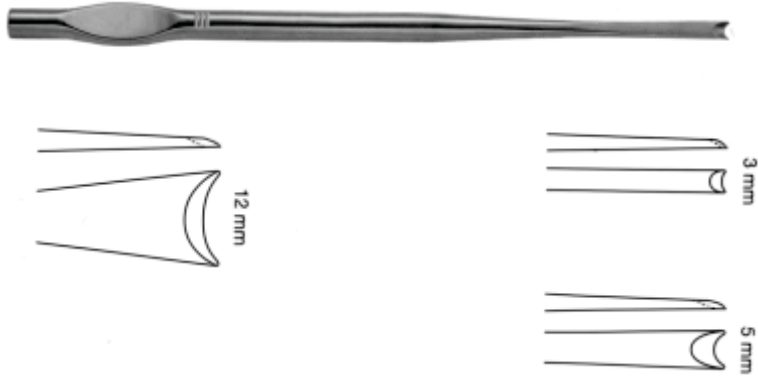

WALTER CHISEL/OSTEOTOME

Item Code Description

TWS 84-3061/83 19CM, 3MM, MODIFIED

TWS 84-3061/84 19CM, 5MM, MODIFIED

TWS 84-3061/85 19CM, 12MM, MODIFIED

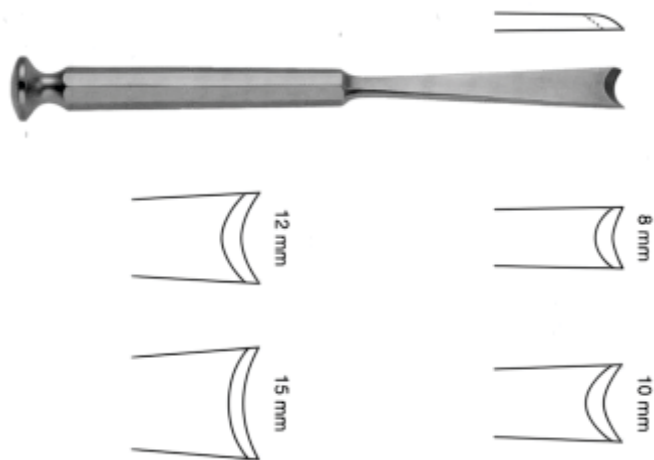

MCINDOE CHISEL

Item Code Description

TWS 84-3061/86 16CM, 8MM

TWS 84-3061/87 16CM, 10MM

TWS 84-3061/88 16CM, 12MM

TWS 84-3061/89 16CM, 15MM

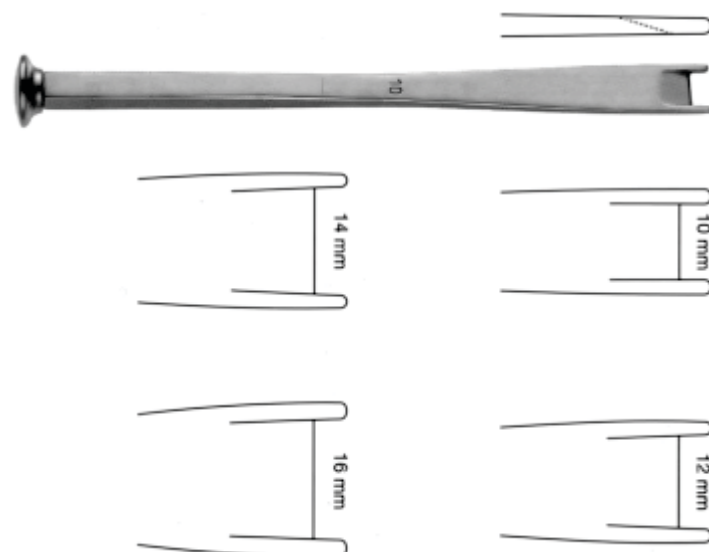

MOBERG CHISEL

Item Code Description

TWS 84-3061/90 18CM, 10MM

TWS 84-3061/91 18CM, 12MM

TWS 84-3061/92 18CM, 14MM

TWS 84-3061/93 18CM, 16MM



BRAITHWAITE NASAL CHISEL

Item Code Description

TWS 84-3061/94 RIGHT, 5 MM WIDTH, 5 1/2" (140 MM)
TWS 84-3061/95 LEFT, 5 MM WIDTH, 5 1/2" (140 MM)



CLODIUS BONE CHISEL

Item Code Description

TWS 84-3061/96 6 MM WIDTH, 8 3/4" (222 MM) LENGTH
8 MM WIDTH, 8 3/4" (222 MM) LENGTH
10 MM WIDTH, 8 3/4" (222 MM) LENGTH
20 MM WIDTH, 8 3/4" (222 MM) LENGTH



TW Surgical

OSTEOTOMES & RASPATORIES



9 mm

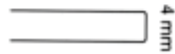

4 mm



12 mm



7 mm

COTTLE OSTEOTOME, 18CM

Item Code Description

TWS 84-3061/97 4MM, STRAIGHT, GRADUATED

TWS 84-3061/98 7MM, STRAIGHT, GRADUATED

TWS 84-3061/99 9MM, STRAIGHT, GRADUATED

TWS 84-3062/00 12MM, STRAIGHT, GRADUATED



3 mm

GUBISCH OSTEOTOME

Item Code Description

TWS 84-3062/01 18.5CM, 3MM, ALUMINIUM HANDLE



16 mm

COTTLE OSTEOTOME, 18CM

Item Code Description

TWS 84-3062/02 16MM, FISHTAIL SHAPED END, STRAIGHT, GRADUATED



14 mm



10 mm

RUBIN NASAL OSTEOTOME, 18CM

Item Code Description

TWS 84-3062/03 10MM

TWS 84-3062/04 14MM

OSTEOTOMES & RASPATORIES



TW Surgical



COTTLE OSTEOTOME, 18CM

Item Code Description
TWS 84-3062/05 6MM, CURVED, GRADUATED



COTTLE BONE LEVER/SPLITTING OSTEOTOME,

Item Code Description
TWS 84-3062/06 20CM, 10MM



GUBISCH FANOUS NASAL OSTEOTOME

Item Code Description
TWS 84-3062/07 19.5CM, NARROW, DELICATE, WITH GUIDE THORN

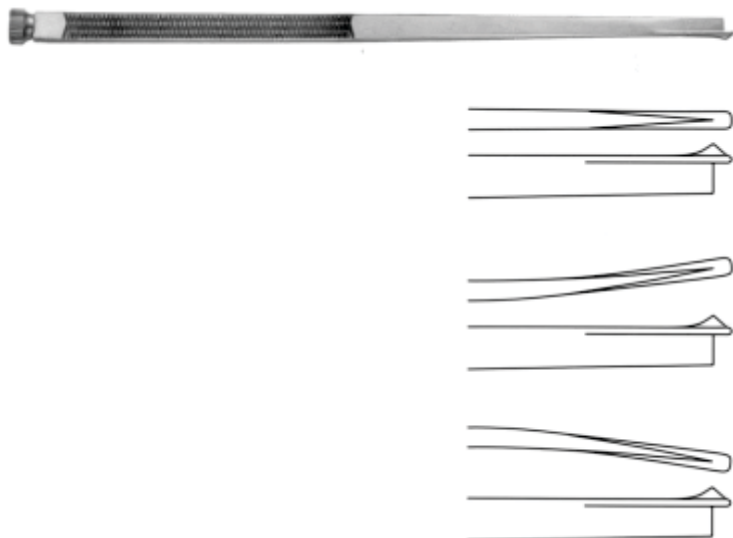

FANOUS OSTEOTOME, 19.5CM

Item Code Description
TWS 84-3062/08 4MM, STRAIGHT, WITH GUIDE THORN
TWS 84-3062/09 4MM, LEFT, WITH GUIDE THORN
TWS 84-3062/10 4MM, RIGHT, WITH GUIDE THORN

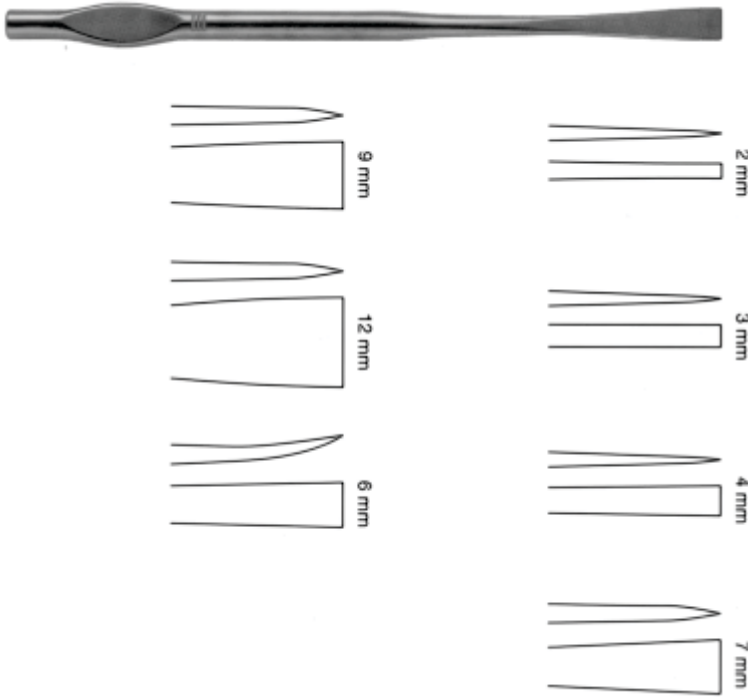

WALTER OSTEOTOME, 19CM

Item Code	Description
TWS 84-3062/11	2MM
TWS 84-3062/12	3MM
TWS 84-3062/13	4MM
TWS 84-3062/14	7MM
TWS 84-3062/15	9MM,
TWS 84-3062/16	12MM,
TWS 84-3062/17	6MM, CURVED

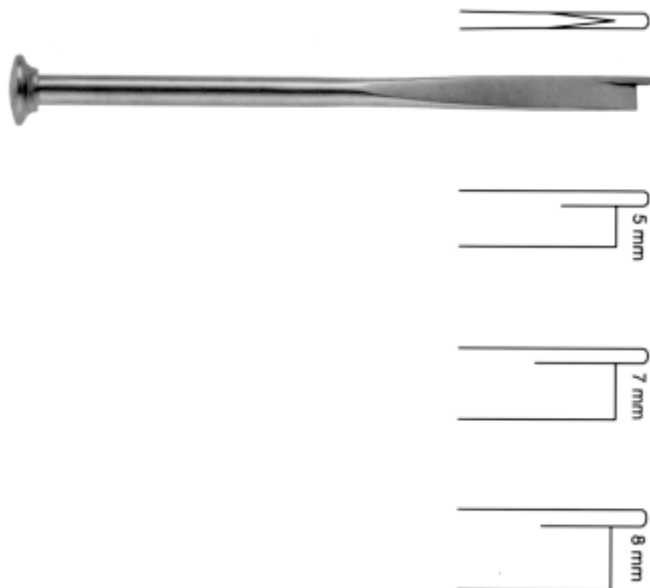

FOMON OSTEOTOME, 17CM

Item Code	Description
TWS 84-3062/18	5MM, STRAIGHT
TWS 84-3062/19	7MM, STRAIGHT
TWS 84-3062/20	8MM, STRAIGHT

OSTEOTOMES & RASPATORIES

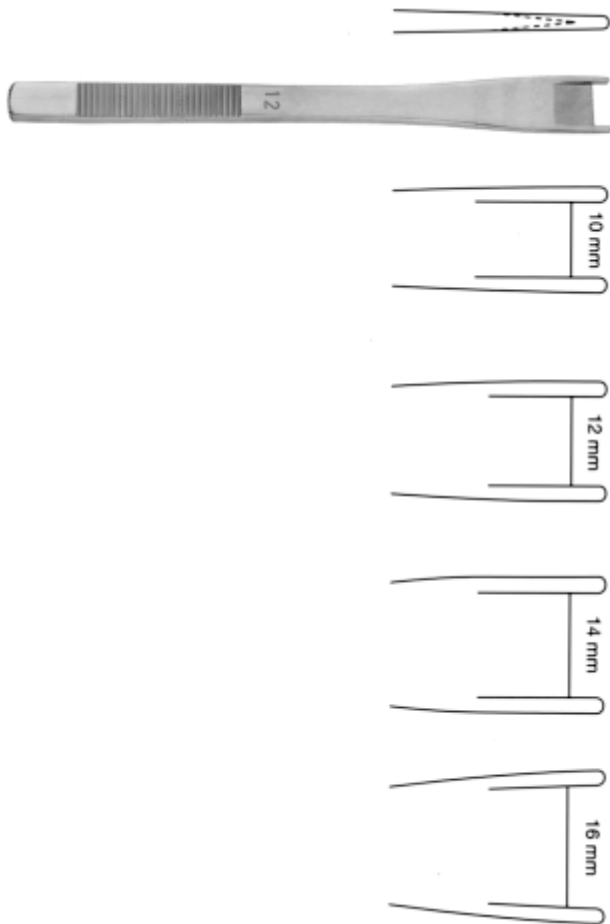

CINELLI GUARDED OSTEOTOME, 16CM

Item Code	Description
<u>TWS 84-3062/21</u>	<u>10MM, STRAIGHT</u>
<u>TWS 84-3062/22</u>	<u>12MM, STRAIGHT</u>
<u>TWS 84-3062/23</u>	<u>14MM, STRAIGHT</u>
<u>TWS 84-3062/24</u>	<u>16MM, STRAIGHT</u>



OBWEGESER PERIOSTEAL ELEVATOR / RASPATORY, 20CM

Item Code	Description
<u>TWS 84-3062/25</u>	<u>704MM, CURVED, SHARP</u>
<u>TWS 84-3062/26</u>	<u>10X7MM, CURVED, SHARP</u>
<u>TWS 84-3062/27</u>	<u>11X9MM, CURVED, SHARP</u>



TW Surgical

OSTEOTOMES & RASPATORIES

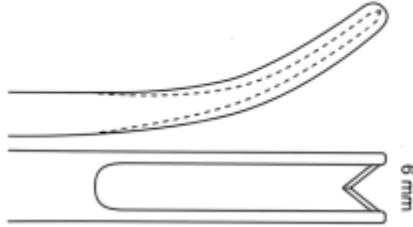

BLUME GUARDED OSTEOTOME, 18CM

Item Code Description

TWS 84-3062/28 6MM,CURVED, V SHAPED TIP

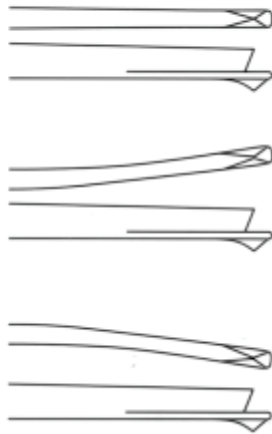
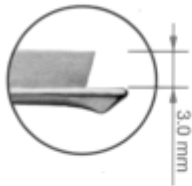

SCHROM OSTEOTOME, 19.5CM

Item Code Description

TWS 84-3062/29 3MM, STRAIGHT, WITH GUIDE THORN

TWS 84-3062/30 3MM, RIGHT, WITH GUIDE THORN

TWS 84-3062/31 3MM, LEFT, WITH GUIDE THORN

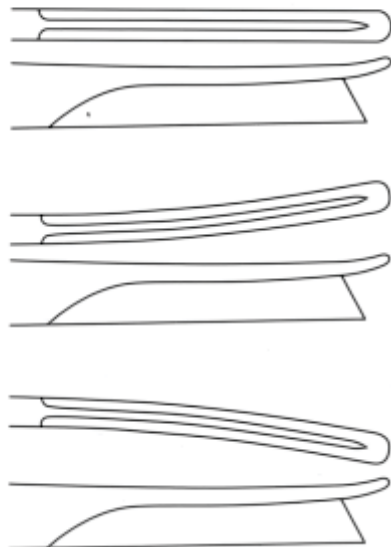

SILVER OSTEOTOME, 18CM

Item Code Description

TWS 84-3062/32 STRAIGHT

TWS 84-3062/33 CURVED LEFT

TWS 84-3062/34 CURVED RIGHT

OSTEOTOMES & RASPATORIES

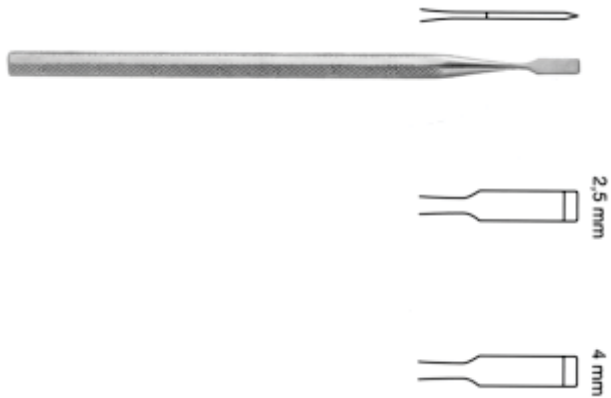

OBWEGESER OSTEOTOME, 15CM

Item Code	Description
<u>TWS 84-3062/35</u>	<u>2.5MM</u>
<u>TWS 84-3062/36</u>	<u>4.0MM</u>



OBWEGESER SPLITTING OSTEOTOME, 21.5CM

Item Code	Description
<u>TWS 84-3062/37</u>	<u>7MM</u>
<u>TWS 84-3062/38</u>	<u>10MM</u>



OBWEGESER WEDGE OSTEOTOME, 22CM

Item Code	Description
<u>TWS 84-3062/39</u>	<u>8MM</u>
<u>TWS 84-3062/40</u>	<u>12MM</u>
<u>TWS 84-3062/41</u>	<u>16MM</u>



TW Surgical

OSTEOTOMES & RASPATORIES

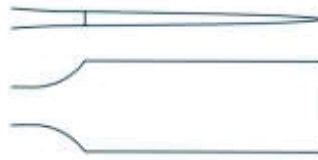

OBWEGESER BLADE OSTEOTOME, 22CM

Item Code	Description
TWS 84-3062/42	8MM
TWS 84-3062/43	12MM
TWS 84-3062/44	16MM
TWS 84-3062/45	20MM

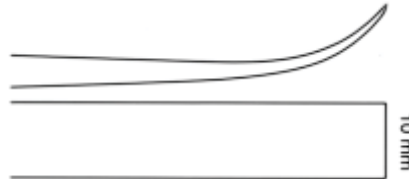

OBWEGESER PTERYGOID OSTEOTOME

Item Code	Description
TWS 84-3062/46	23.5CM, 10MM, CURVED

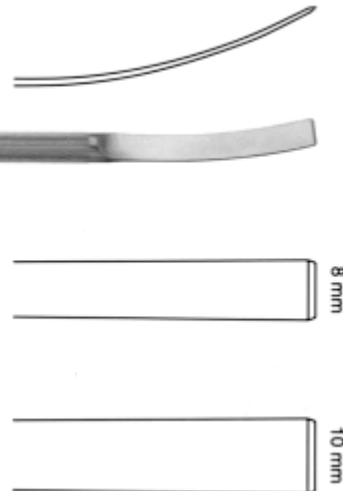

OBWEGESER FLEXIBLE OSTEOTOME, 21CM

Item Code	Description
TWS 84-3062/47	8MM, CURVED
TWS 84-3062/48	10MM, CURVED

OSTEOTOMES & RASPATORIES



TW Surgical



TESSIER OSTEOTOME, 20.5CM

Item Code Description

<u>TWS 84-3062/49</u>	<u>10MM, STRAIGHT</u>
<u>TWS 84-3062/50</u>	<u>10MM, CURVED</u>
<u>TWS 84-3062/61</u>	<u>15MM, STRAIGHT</u>
<u>TWS 84-3062/62</u>	<u>15MM, CURVED</u>
<u>TWS 84-3062/63</u>	<u>20MM, STRAIGHT</u>
<u>TWS 84-3062/64</u>	<u>30MM, STRAIGHT</u>



10 mm



10 mm



15 mm



15 mm

TESSIER OSTEOTOME, 16CM,

Item Code Description

<u>TWS 84-3062/65</u>	<u>10MM, STRAIGHT, BEVELED EDGES</u>
<u>TWS 84-3062/66</u>	<u>10MM, CURVED, BEVELED EDGES</u>
<u>TWS 84-3062/67</u>	<u>15MM, STRAIGHT, BEVELED EDGES</u>
<u>TWS 84-3062/68</u>	<u>16CM, 15MM, CURVED, BEVELED EDGES</u>



TW Surgical

OSTEOTOMES & RASPATORIES

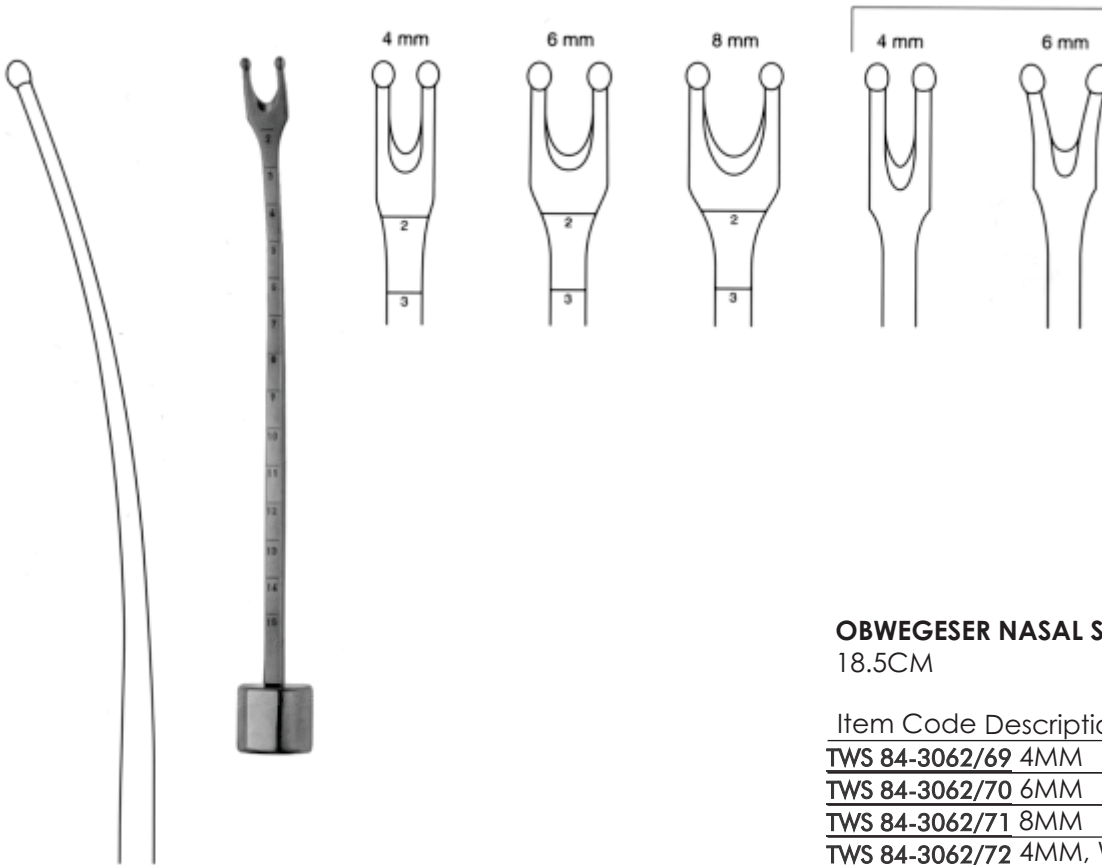

OBWEGESER NASAL SEPTUM OSTEOTOME, 18.5CM

Item Code	Description
<u>TWS 84-3062/69</u>	<u>4MM</u>
<u>TWS 84-3062/70</u>	<u>6MM</u>
<u>TWS 84-3062/71</u>	<u>8MM</u>
<u>TWS 84-3062/72</u>	<u>4MM, WITHOUT SCALE</u>

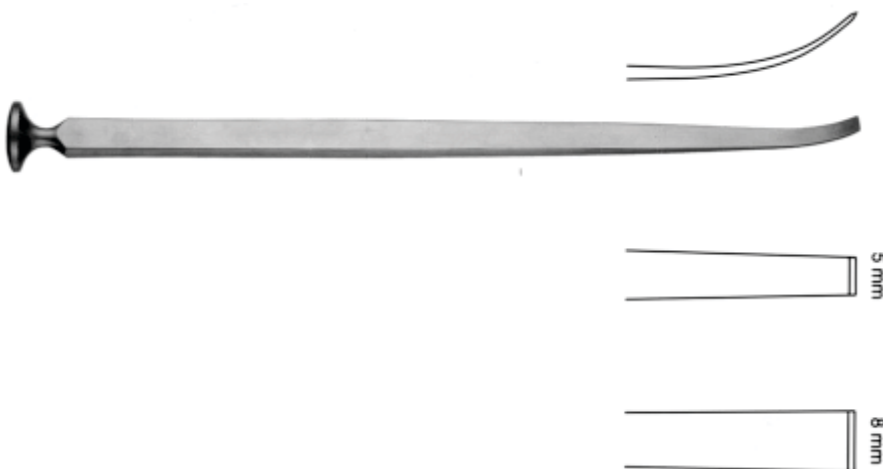

STEINHAUSER ORBITAL OSTEOTOME, 22.5CM,

Item Code	Description
<u>TWS 84-3062/73</u>	<u>5MM, CURVED</u>
<u>TWS 84-3062/74</u>	<u>8MM, CURVED</u>

OSTEOTOMES & RASPATORIES



TW Surgical



ROZNER NASAL OSTEOTOME, 6.5 MM

Item Code Description
TWS 84-3062/75 WIDTH, 6 1/2" (165 MM) LENGTH



GIUNTA OSTEOTOME

Item Code Description
TWS 84-3062/76 DOUBLE GUARDED, CURVED, 4 MM
WIDTH, 7" (178 MM) LENGTH



LAMBOTTE OSTEOTOME, 5" (127 MM)

Item Code Description
TWS 84-3062/77 4 MM
TWS 84-3062/78 6 MM
TWS 84-3062/79 8 MM
TWS 84-3062/80 10 MM
TWS 84-3062/81 12 MM



FREER RASPATORY, 19CM

Item Code Description
TWS 84-3062/82 5/5MM, DOUBLE ENDED, SHARP / SHARP

Treasure Wright (U.K.) Ltd.

128-160 City Road, London, EC1V 2NX, United Kingdom
info@twrightmedical.com

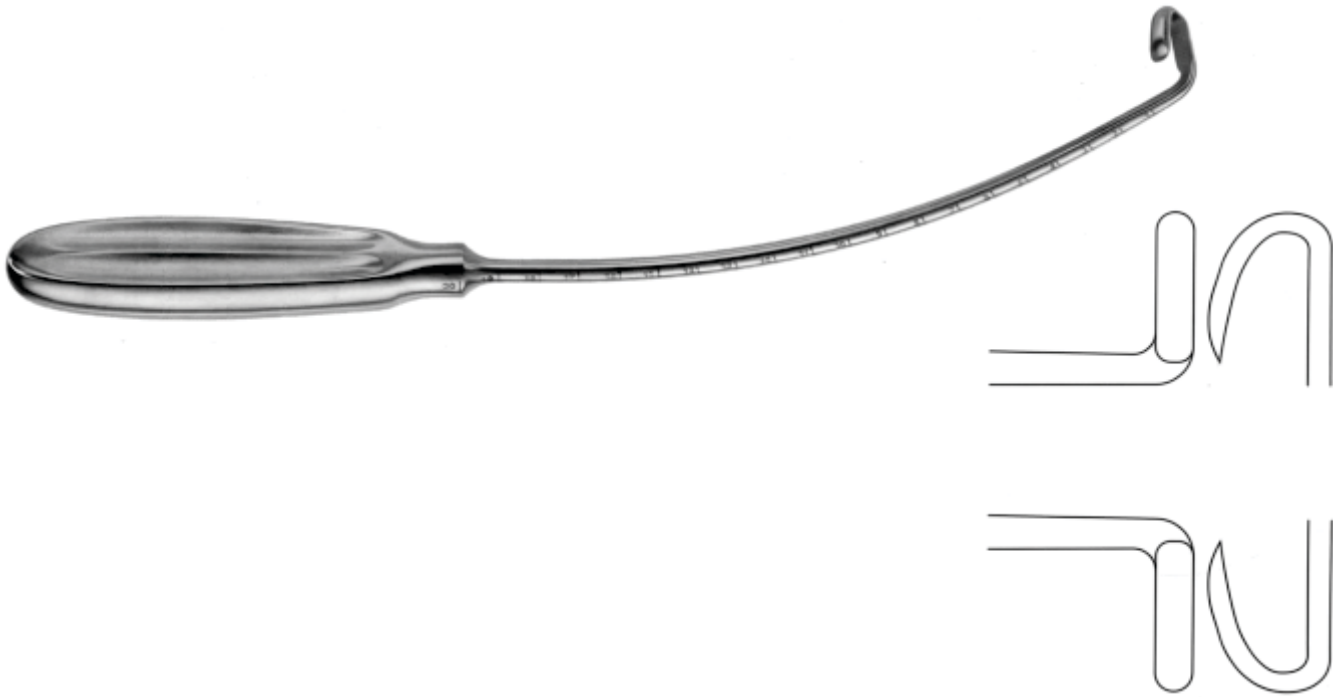

OBWEGESER RIB RASPATORY, 30CM

Item Code Description

TWS 84-3062/83 LEFT

TWS 84-3062/84 RIGHT

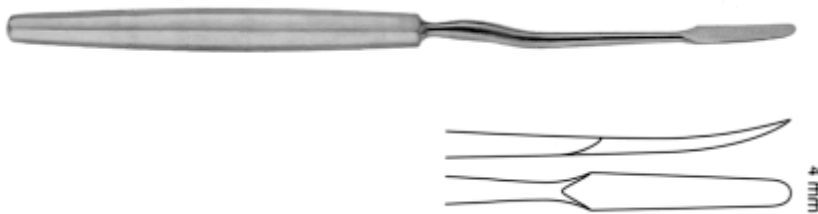

JOSEPH MASING SEPTUM RASPATORY

Item Code Description

TWS 84-3062/85 22CM, 4MM, SHARP



COTTLE PERIOSTEAL ELEVATOR/RASPATORY

Item Code Description

TWS 84-3062/86 18CM, 8MM, SHARP

OSTEOTOMES & RASPATORIES



**CONVERSE PERIOSTEAL ELEVATOR/
RASPATORY, 18CM**

Item Code Description
TWS 84-3062/87 5MM, SHARP

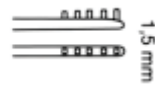
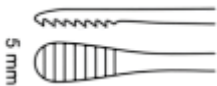

**COTTLE PERIOSTEUM COMB
AND RASPATORY, 23CM**

Item Code Description
TWS 84-3062/88 1.5/5MM, DOUBLE ENDED



COTTLE MCKENTY RASPATORY, 22CM

Item Code Description
TWS 84-3062/89 4/4MM, DOUBLE ENDED, SHARP



**OBWEGESER PERIOSTEAL ELEVATOR /
ASPATORY, 17.5CM**

Item Code Description
TWS 84-3062/90 6MM, SHARP
TWS 84-3062/91 7MM, SHARP
TWS 84-3062/92 9MM, SHARP
TWS 84-3062/93 11MM, SHARP



TW Surgical

OSTEOTOMES & RASPATORIES

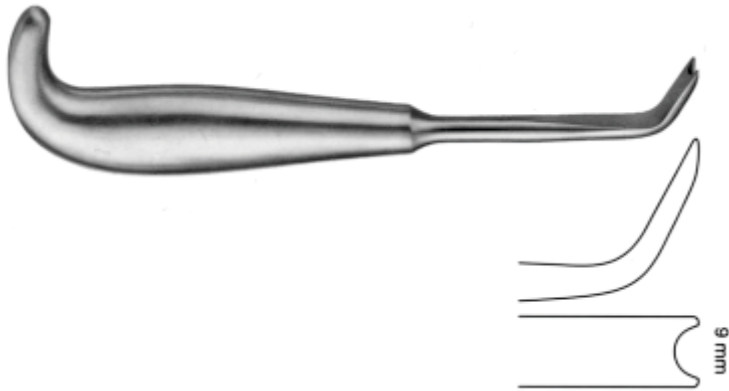

HARGIS RASPATORY, 19CM

Item Code	Description
<u>TWS 84-3062/94</u>	<u>9MM, ANGLED</u>

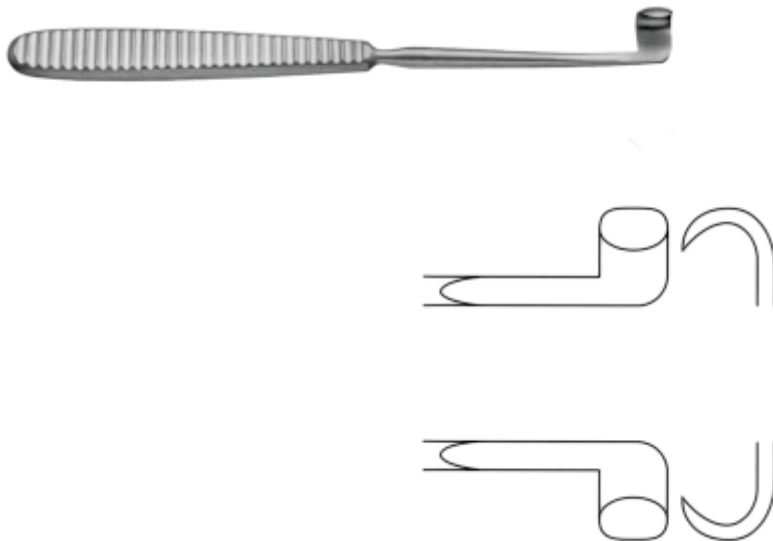

OBWEGESER MANDIBULAR RIM STRIPPER

Item Code	Description
<u>TWS 84-3062/95</u>	<u>19CM</u>

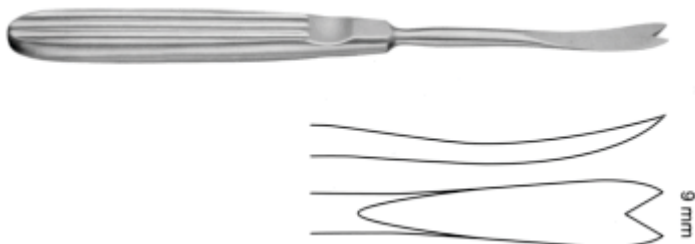

OBWEGESER PERIOSTEAL ELEVATOR / RASPATORY, 17.5CM

Item Code	Description
<u>TWS 84-3062/96</u>	<u>9MM, V NOTCH</u>

OSTEOTOMES & RASPATORIES

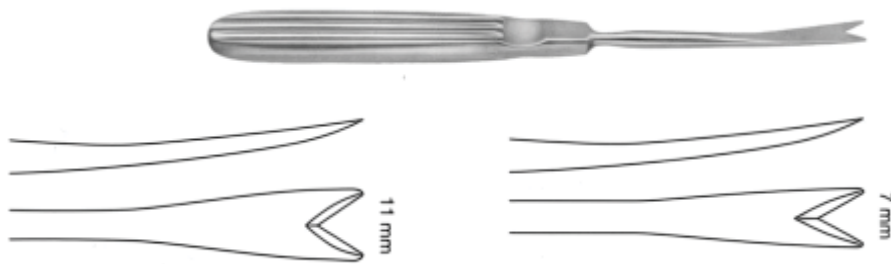

OBWEGESER SWALLOWTAIL STRIPPER, 17.5CM,

Item Code Description
TWS 84-3062/97 7MM
TWS 84-3062/98 11MM

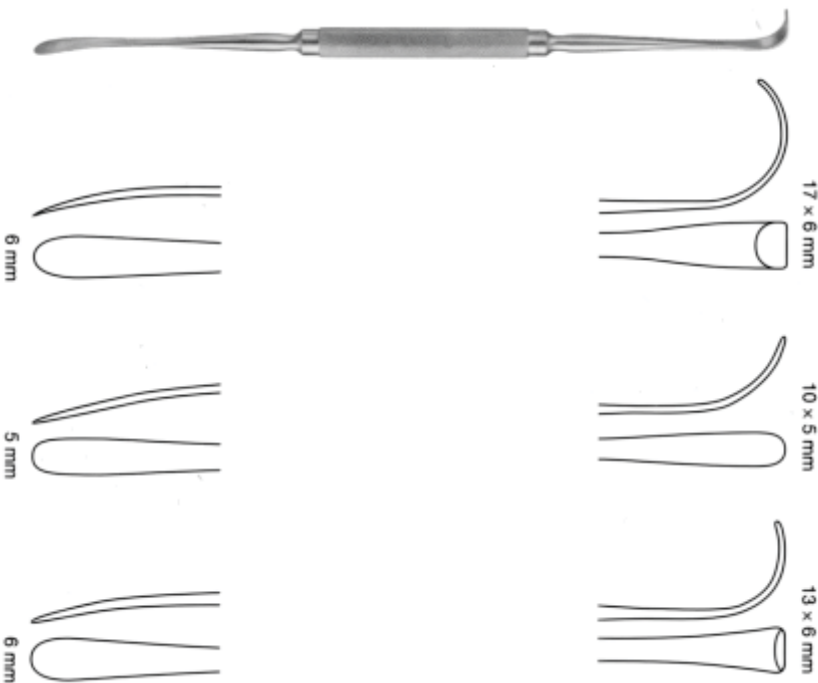

OBWEGESER FREER PERIOSTEAL ELEVATOR, 21CM,

Item Code Description
TWS 84-3062/99 6MM SHARP / 1705MM BLUNT
TWS 84-3063/00 5MM SHARP / 10X5MM BLUNT
TWS 84-3063/01 6MM SHARP / 1305MM BLUNT

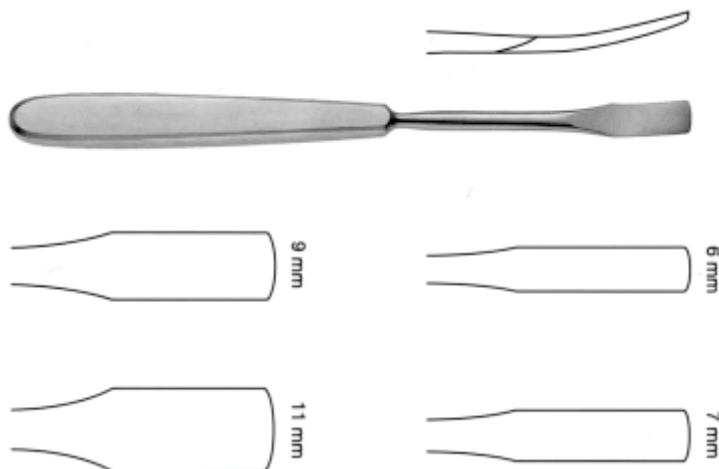

OBWEGESER PERIOSTEAL ELEVATOR, 18CM

Item Code Description
TWS 84-3063/02 6MM, BEVELED EDGE
TWS 84-3063/03 7MM, BEVELED EDGE
TWS 84-3063/04 9MM, BEVELED EDGE
TWS 84-3063/05 11MM, BEVELED EDGE



TW Surgical

OSTEOTOMES & RASPATORIES

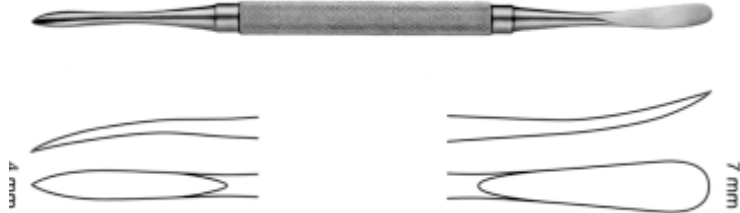

DINGMAN PERIOSTEAL ELEVATOR / RASPATORY, 18CM

Item Code Description
TWS 84-3063/06 4/7MM, SHARP / BLUNT



TESSIER RASPATORY, 18CM,

Item Code Description
TWS 84-3063/07 8MM, 30 DEGREE CURVED
TWS 84-3063/08 12MM, 60 DEGREE CURVED



Item Code Description
TWS 84-3063/09 STEINHAUSER ORBITAL FLOOR
RASPATORY, 17CM, 9X4MM

MUCOSA KNIFE & RASPATORIES



TW Surgical

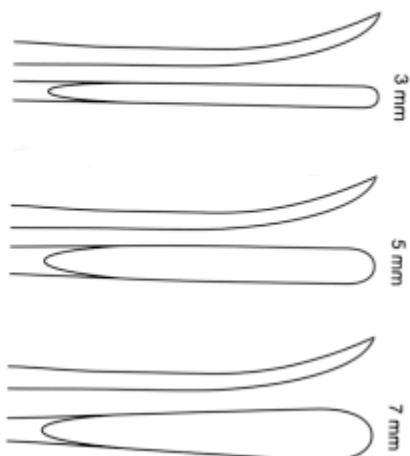

WILLIGER RASPATORY, 16CM

Item Code Description
TWS 84-3063/10 3MM, SHARP
TWS 84-3063/11 5MM, SHARP
TWS 84-3063/12 7MM, SHARP

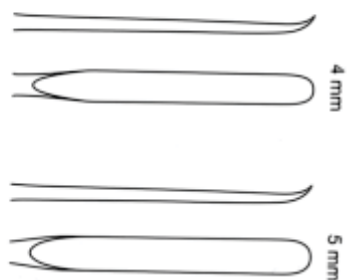

MCKENTY RASPATORY, 15CM

Item Code Description
TWS 84-3063/13 4MM, SHARP, LIGHT CURVE
TWS 84-3063/14 5MM, SHARP, LIGHT CURVE



FREER MUCOSA END KNIFE

Item Code Description
TWS 84-3063/15 6" (15 CM)



TW Surgical

RHINOPLASTY FILES & RASPS

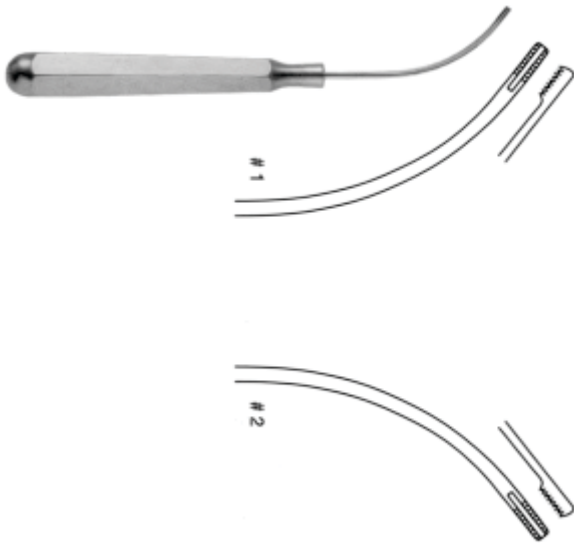

DINGMAN CARTILAGE ABRADERS, SET OF TWO

Item Code Description

TWS 84-3063/16 #1, 15CM, CURVED LEFT

TWS 84-3063/17 #2, 15CM, CURVED RIGHT

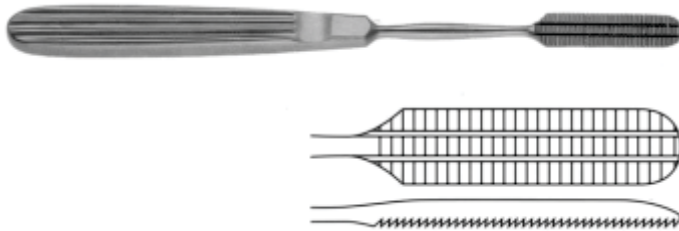

MALTZ NASAL RASP

Item Code Description

TWS 84-3063/18 18.5CM



LEWIS NASAL RASP

Item Code Description

TWS 84-3063/19 20CM

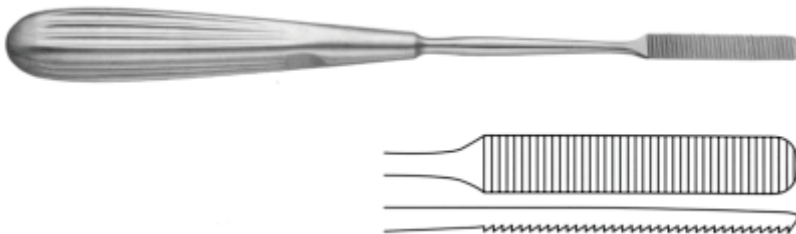

COTTLE NASAL RASP

Item Code Description

TWS 84-3063/20 21CM

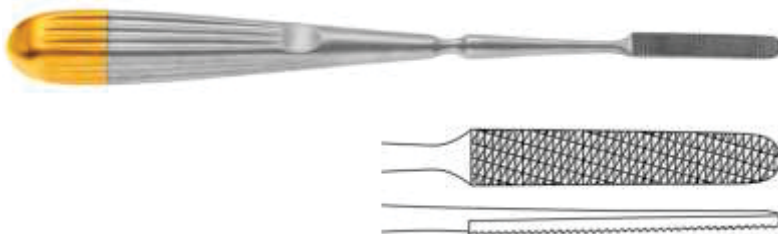

COTTLE T.C. NASAL RASP

Item Code Description

TWS 84-3063/21 20.5CM

Treasure Wright (U.K.) Ltd.

128-160 City Road, London, EC1V 2NX, United Kingdom
info@twrightmedical.com

RHINOPLASTY FILES & RASPS

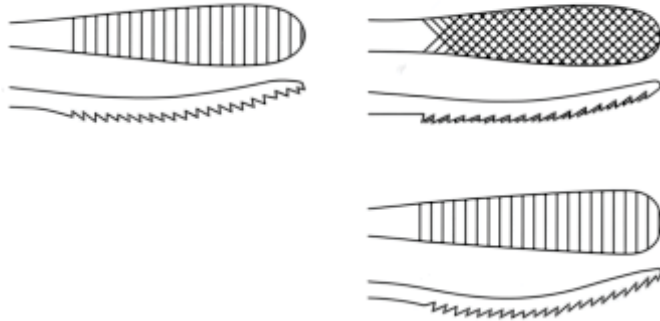

AUFRICHT NASAL RASP, 21CM

Item Code	Description
<u>TWS 84-3063/22</u>	<u>CROSS CUT</u>
<u>TWS 84-3063/23</u>	<u>DOWN</u>
<u>TWS 84-3063/24</u>	<u>UP</u>

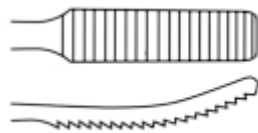

NASAL RASP

Item Code	Description
<u>TWS 84-3063/25</u>	<u>19.5CM, UP</u>

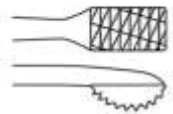

LEWIS T.C. NASAL RASP

Item Code	Description
<u>TWS 84-3063/26</u>	<u>19.5CM</u>

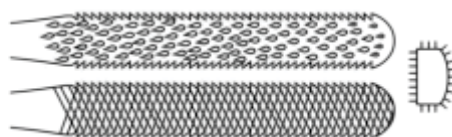
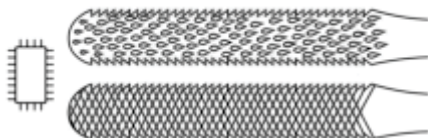

FOMON BONE AND NASAL RASP

Item Code	Description
<u>TWS 84-3063/27</u>	<u>20CM</u>



TW Surgical

RHINOPLASTY FILES & RASPS

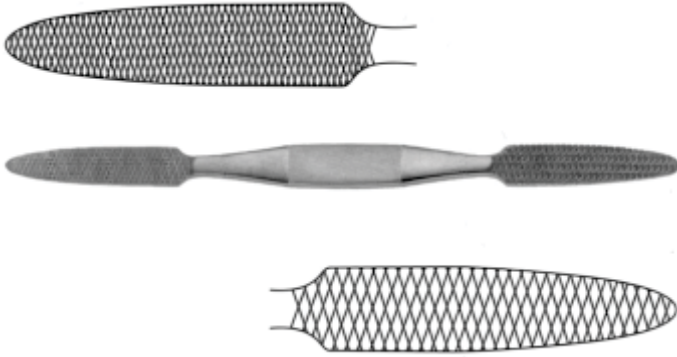

CONVERSE BONE AND NASAL FILE

Item Code	Description
<u>TWS 84-3063/28</u>	<u>18.5CM</u>

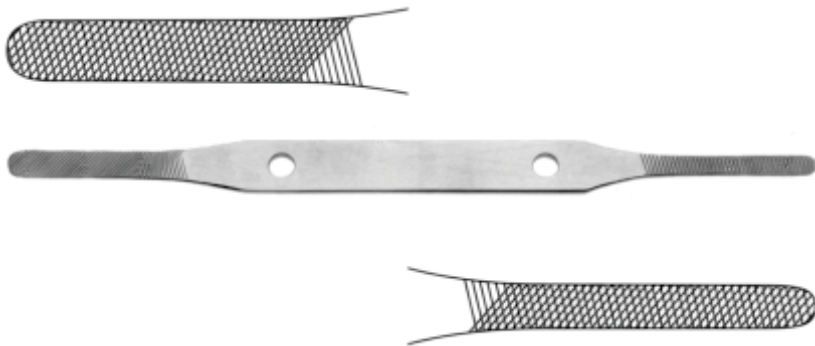

MASING NASAL FILE

Item Code	Description
<u>TWS 84-3063/29</u>	<u>21CM, FINE</u>

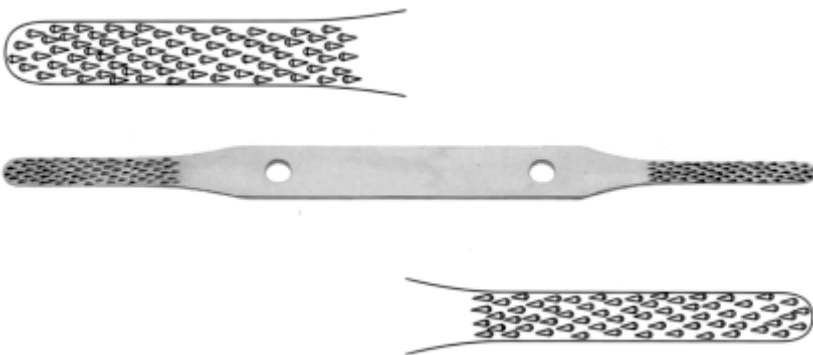

MASING NASAL RASP

Item Code	Description
<u>TWS 84-3063/30</u>	<u>21CM, COARSE</u>

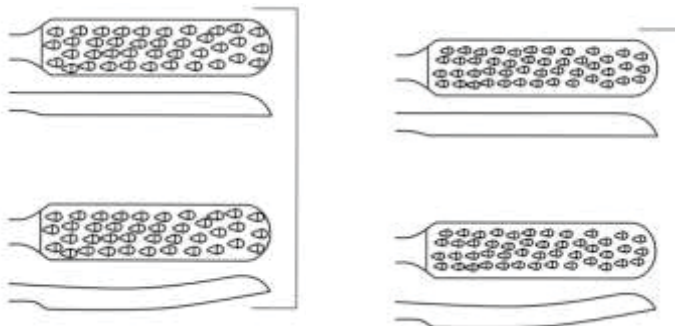

OBWEGESER NASAL RASP, 19.5CM

Item Code	Description
<u>TWS 84-3063/31</u>	<u>FLAT, FINE, DELICATE PATTERN</u>
<u>TWS 84-3063/32</u>	<u>FLAT, MEDIUM FINE</u>
<u>TWS 84-3063/33</u>	<u>CONVEX, FINE, DELICATE PATTERN</u>
<u>TWS 84-3063/34</u>	<u>CONVEX, MEDIUM FINE</u>

RHINOPLASTY FILES & RASPS



TW Surgical



GUBISCH FOMON T.C. NASAL RASP, 20CM

<u>Item Code</u>	<u>Description</u>
<u>TWS 84-3063/35</u>	<u>#1 and #2</u>
<u>TWS 84-3063/36</u>	<u>#3 and #4</u>
<u>TWS 84-3063/37</u>	<u>#5 and #6</u>
<u>TWS 84-3063/38</u>	<u>#7 and #8</u>
<u>TWS 84-3063/39</u>	<u>#9 and #10</u>



TW Surgical

RHINOPLASTY FORCEPS

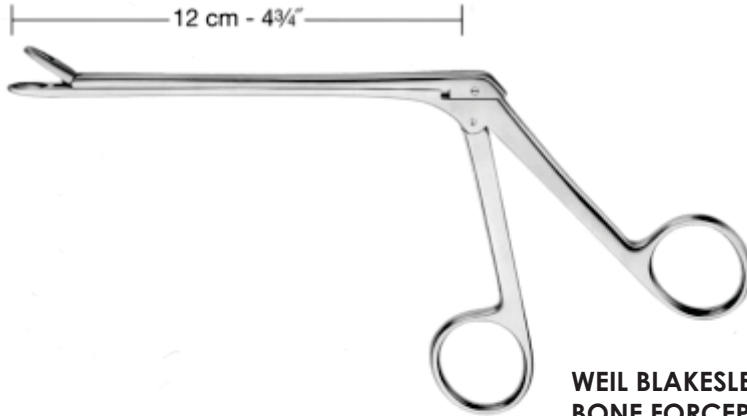

WEIL BLAKESLEY WILDE ETHMOID BONE FORCEP

NORMAL SHAFT



3,0 mm		TWS 84-3063/40	TWS 84-3063/45	TWS 84-3063/49
3,6 mm		TWS 84-3063/41	TWS 84-3063/46	TWS 84-3063/50
4,2 mm		TWS 84-3063/42	TWS 84-3063/47	TWS 84-3063/51
4,8 mm		TWS 84-3063/43	TWS 84-3063/48	
5,6 mm		TWS 84-3063/44		

SLIM SHAFT



3,0 mm		TWS 84-3063/52	TWS 84-3063/57
3,6 mm		TWS 84-3063/53	TWS 84-3063/58
4,2 mm		TWS 84-3063/54	TWS 84-3063/59
4,8 mm		TWS 84-3063/55	TWS 84-3063/60
5,6 mm		TWS 84-3063/56	

Treasure Wright (U.K.) Ltd.

128-160 City Road, London, EC1V 2NX, United Kingdom
info@twrightmedical.com

RHINOPLASTY FORCEPS



TW Surgical

11,5 cm - 4½"



WEIL BLAKESLEY FORCEPS, THROUGH CUT



2,0 mm 

TWS 84-3063/61

TWS 84-3063/64

2,5 mm 

TWS 84-3063/62

TWS 84-3063/65

3,0 mm 

TWS 84-3063/63

TWS 84-3063/66



TW Surgical

RHINOPLASTY RETRACTORS



COTTLE DOUBLE HOOK, 15CM

Item Code	Description
TWS 84-3063/67	SHARP, 3X4MM

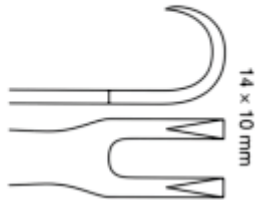

KILNER DOUBLE NASAL HOOK, 10CM

Item Code	Description
TWS 84-3063/68	SHARP, 1409MM

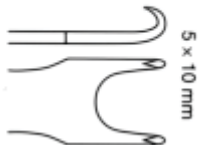

GUBISCH KILNER DOUBLE NASAL HOOK (ALAR RETRACTOR)

Item Code	Description
TWS 84-3063/69	8CM, SHARP, 5090 MM

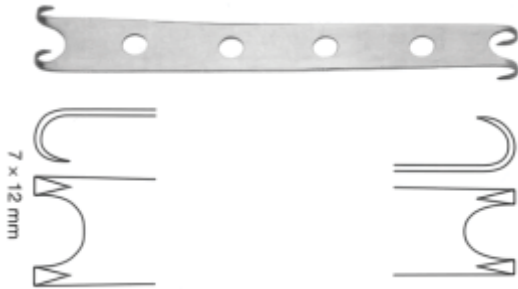

CONVERSE ALAR RETRACTOR, 12CM

Item Code	Description
TWS 84-3063/70	DOUBLE ENDED, 709MM AND 7X14MM

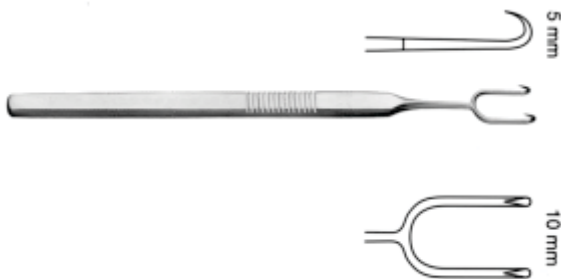

COTTLE ALAR AND SKIN HOOK, 14CM

Item Code	Description
TWS 84-3063/71	2 PRONGS, SHARP, 509MM

RHINOPLASTY RETRACTORS



MILLARD COTTLE RETRACTOR



Item Code	Description
TWS 84-3063/72	WITH FINGER RING, 5.5CM, DOUBLE PRONG, SHARP, 5X12MM

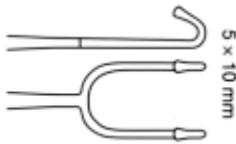

FOMON RETRACTOR, 17CM

Item Code	Description
TWS 84-3063/73	BALL TIPS, 5 X 10 MM



COTTLE RETRACTOR, 15CM

Item Code	Description
TWS 84-3063/74	4 PRONGS, BLUNT, 10090 MM

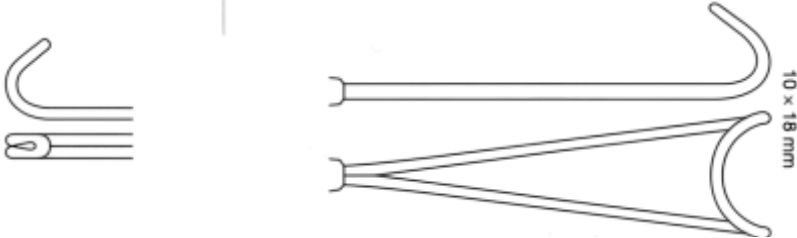

MASING RETRACTOR, 20CM

Item Code	Description
TWS 84-3063/75	WITH GUIDE CHANNEL, 10X18MM

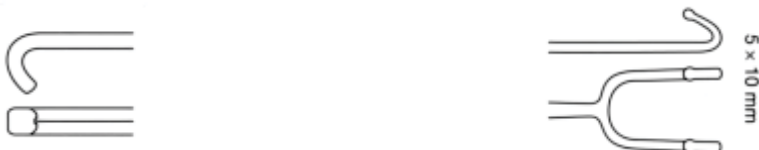

NEIVERT RETRACTOR, 19CM

Item Code	Description
TWS 84-3063/76	DOUBLE ENDED, WITH GUIDE CHANNEL, 509MM



TW Surgical

RHINOPLASTY RETRACTORS



COTTLE NEIVERT RETRACTOR, 21CM

Item Code Description

TWS 84-3063/77 DOUBLE ENDED, 5090MM



COTTLE ALAR RETRACTOR, 14CM,

Item Code Description

TWS 84-3063/78 13X12MM

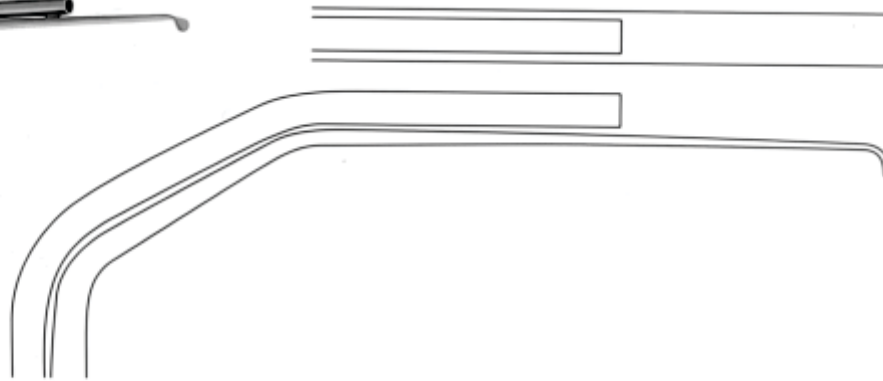

WALTER ALAR AND NASAL RETRACTOR

Item Code Description

TWS 84-3063/79 WITH FIBER OPTIC ILLUMINATION, 18.5CM

RHINOPLASTY RETRACTORS

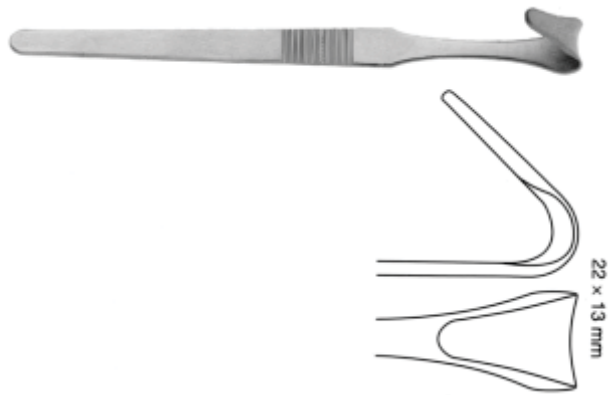

COTTLE ALAR RETRACTOR, 15CM

Item Code Description
TWS 84-3063/80 22X13MM

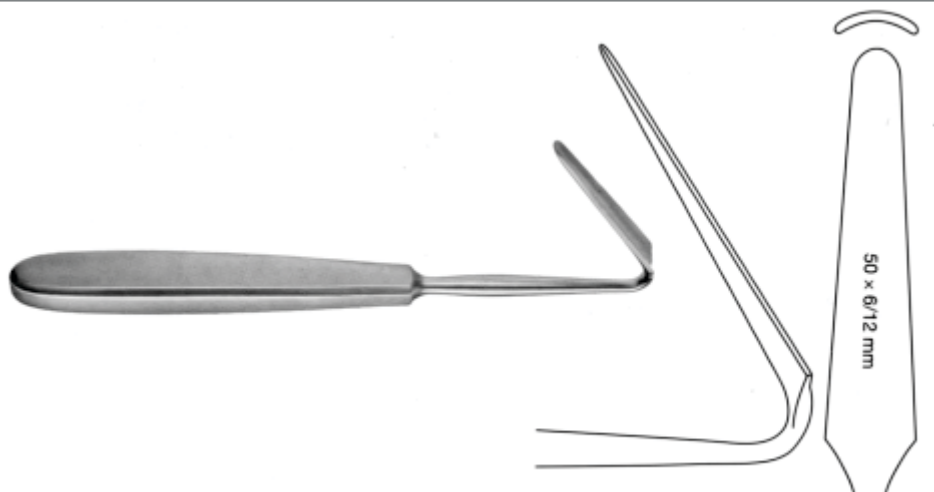

**GUBISCH AUFRICHT NASAL RETRACTOR,
17CM**

Item Code Description
TWS 84-3063/8150X6-12MM

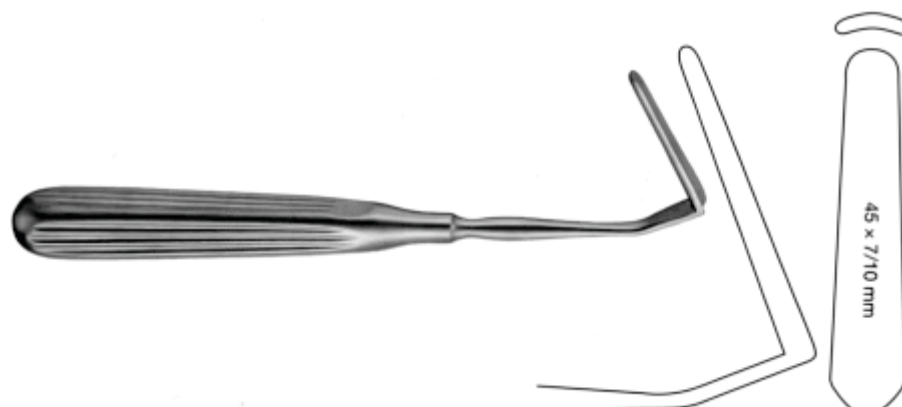

**AUFRICHT NASAL RETRACTOR,
18CM**

Item Code Description
TWS 84-3063/82 45X7-10MM



TW Surgical

RHINOPLASTY RETRACTORS

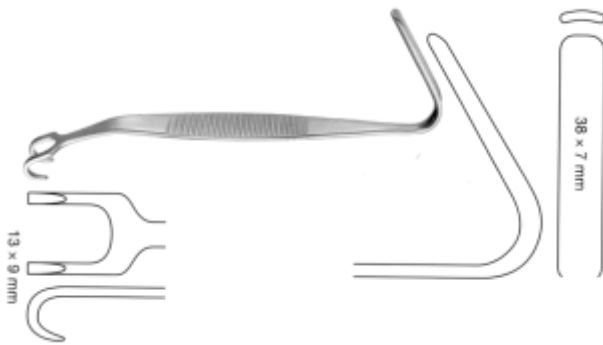

AUFRICHT NASAL RETRACTOR, 13.5CM

Item Code Description
TWS 84-3063/83 DOUBLE ENDED, BLUNT, 38X7MM

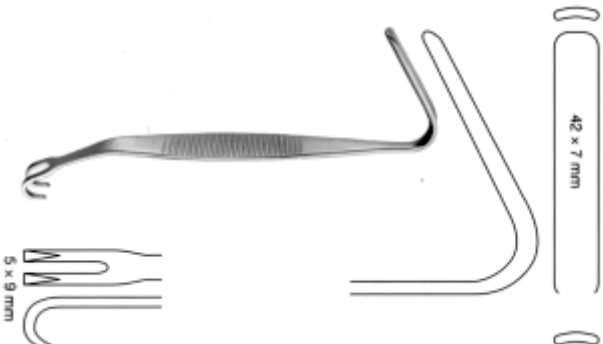

AUFRICHT WALTER NASAL RETRACTOR

Item Code Description
TWS 84-3063/84 13.5CM, DOUBLE ENDED, BLUNT, 38X7MM

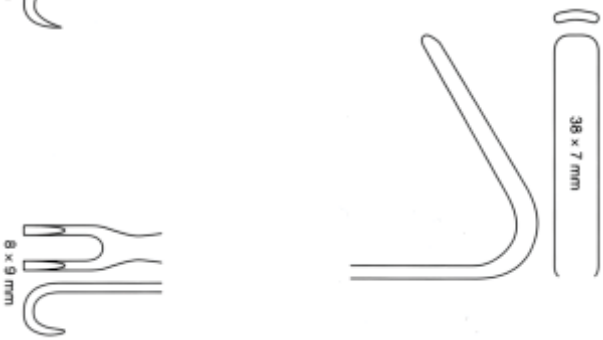

Item Code Description
TWS 84-3063/85 13.5CM, DOUBLE ENDED, SHARP, 42X7MM

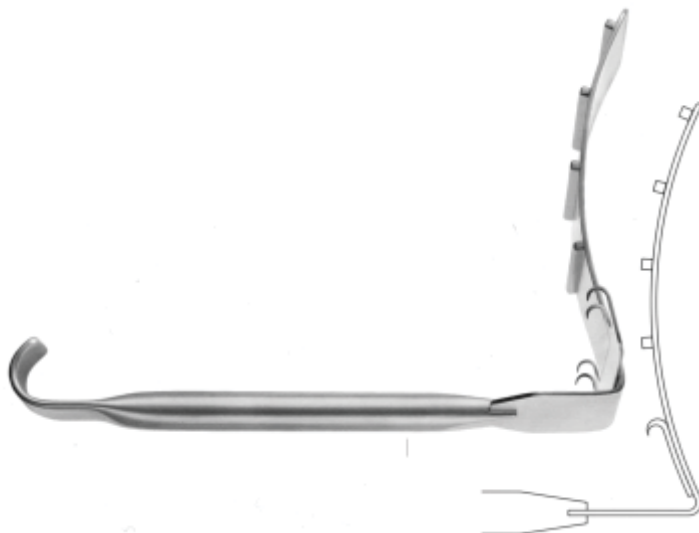

SALDANHA RETRACTOR

Item Code Description
TWS 84-3063/86 9 1/4" (23.5cm)



AUFRICHT NASAL RETRACTOR

Item Code	Description
TWS 84-3063/87	6 1/4" (16CM), 7MM TIP, 45MM BLADE, WITH FIBER OPTIC LIGHT GUIDE
TWS 84-3063/88	7" (18CM), 10MM TIP, 45MM BLADE, WITH FIBER OPTIC LIGHT GUIDE



**CONVERSE BLADE NASAL RETRACTOR,
WITH FIBER OPTIC LIGHT GUIDE**

Item Code	Description
TWS 84-3063/89	20MM X 10MM WIDE
TWS 84-3063/90	30MM X 12MM WIDE
TWS 84-3063/91	40MM X 12MM WIDE
TWS 84-3063/92	50MM X 12MM WIDE,



FOMON NASAL RETRACTOR

Item Code	Description
TWS 84-3063/93	1 BALL END PRONG, 6 1/4" (16 CM)
TWS 84-3063/94	2 BALL END PRONGS, 6 1/4" (16 CM)



TW Surgical

RHINOPLASTY SAWS



JOSEPH NASAL SAW

Item Code	Description
TWS 84-3063/95	17CM, STRAIGHT

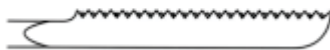

JOSEPH NASAL SAW, 17CM

Item Code	Description
TWS 84-3063/96	LEFT
TWS 84-3063/97	RIGHT

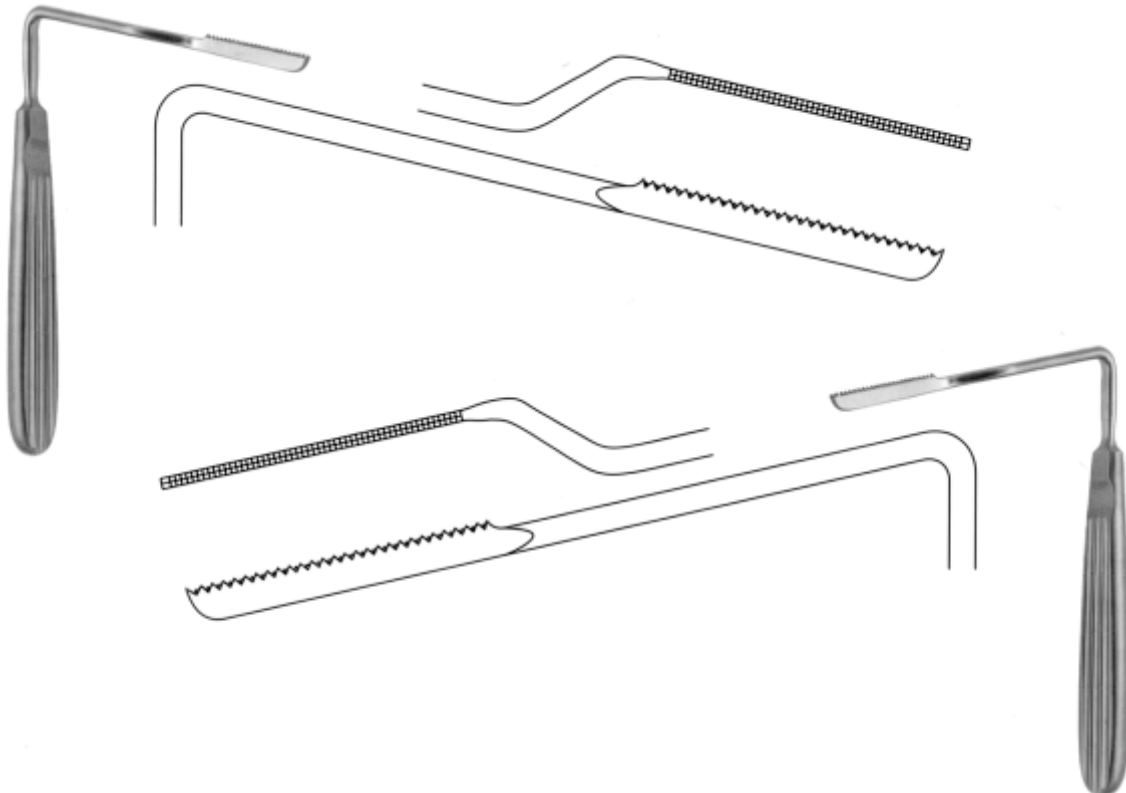

JOSEPH NASAL SAW

Item Code	Description
TWS 84-3063/98	ANGLED TO LEFT
TWS 84-3063/99	ANGLED TO RIGHT

Treasure Wright (U.K.) Ltd.

128-160 City Road, London, EC1V 2NX, United Kingdom
info@twrightmedical.com

RHINOPLASTY SEPTUM FORCEPS

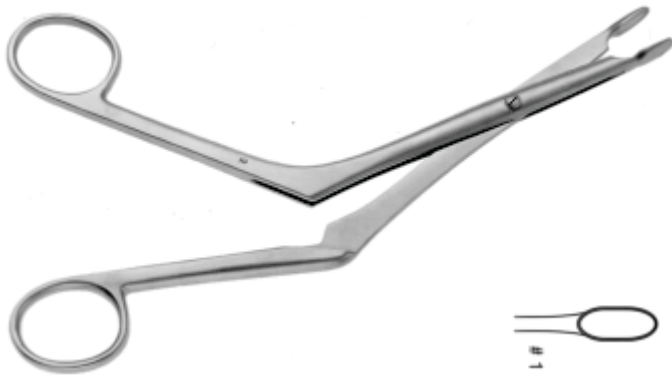

LUC BRUENINGS HEYMANN ETHMOID FORCEPS

Item Code	Description
<u>TWS 84-3064/00</u>	<u>18CM</u>

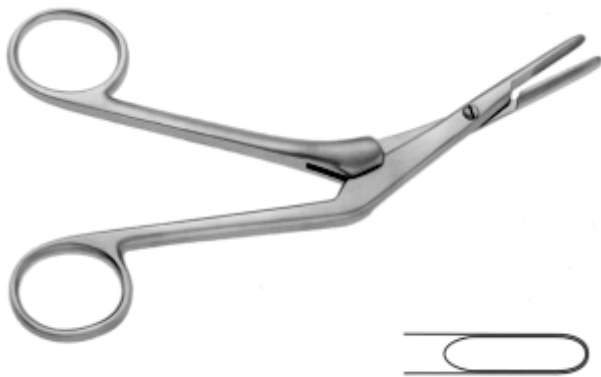

CRAIG VOMER FORCEPS

Item Code	Description
<u>TWS 84-3064/01</u>	<u>17CM</u>



CRAIG DOMNICK SEPTUM FORCEPS, 17CM

Item Code	Description
<u>TWS 84-3064/02</u>	<u>CURVED RIGHT</u>
<u>TWS 84-3064/03</u>	<u>CURVED LEFT</u>



OBWEGESER NASAL SEPTUM CUTTER / PERFORATION FORCEPS

Item Code	Description
<u>TWS 84-3064/04</u>	<u>18.5CM</u>



TW Surgical

RHINOPLASTY SPECULA

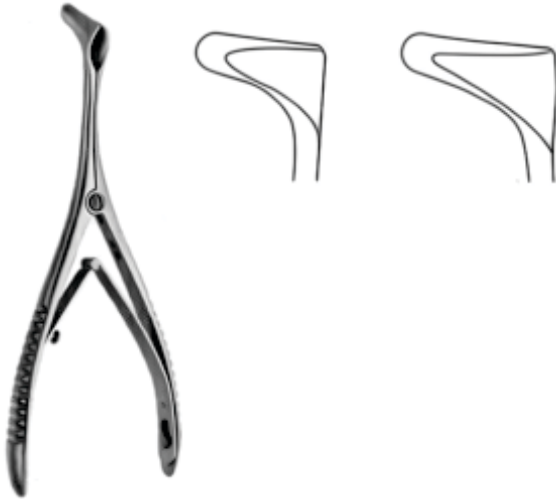

TIECK HALLE NASAL SPECULUM, 13.5CM

Item Code	Description
TWS 84-3064/05	FOR BABIES
TWS 84-3064/06	FOR INFANTS

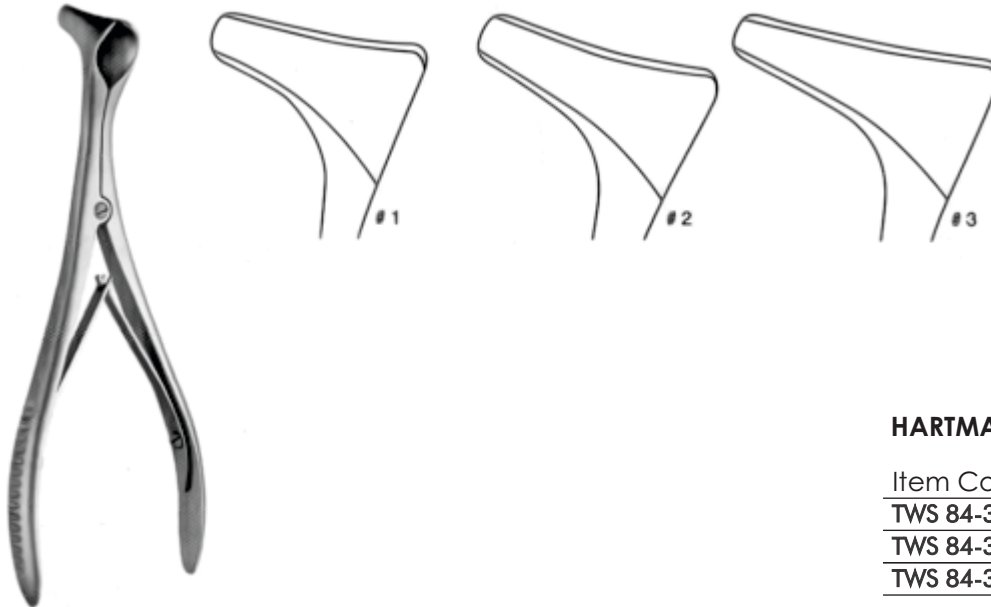

HARTMANN NASAL SPECULUM

Item Code	Description
TWS 84-3064/07	#1, 15CM
TWS 84-3064/08	#2, 15CM
TWS 84-3064/09	#3, 15CM

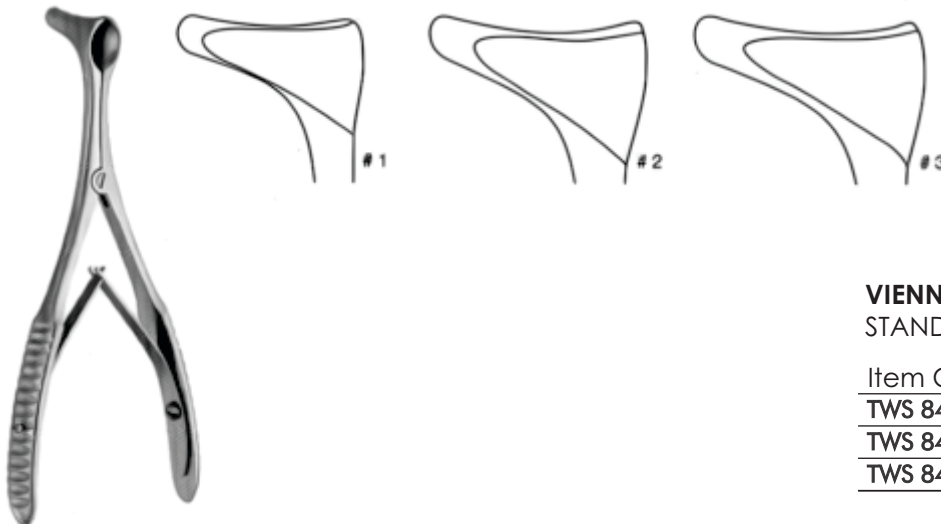

VIENNA MODEL (MODIFIED WIEN) STANDARD NASAL SPECULUM

Item Code	Description
TWS 84-3064/10	#1, 14CM
TWS 84-3064/11	#2, 14CM
TWS 84-3064/12	#3, 14CM



KILLIAN NASAL SPECULUM

<u>Item Code</u>	<u>Description</u>
TWS 84-3064/13	#1, 14CM, 35MM
TWS 84-3064/14	#2, 14CM, 50MM
TWS 84-3064/15	#3, 14CM, 75MM
TWS 84-3064/16	#4, 14CM, 90MM

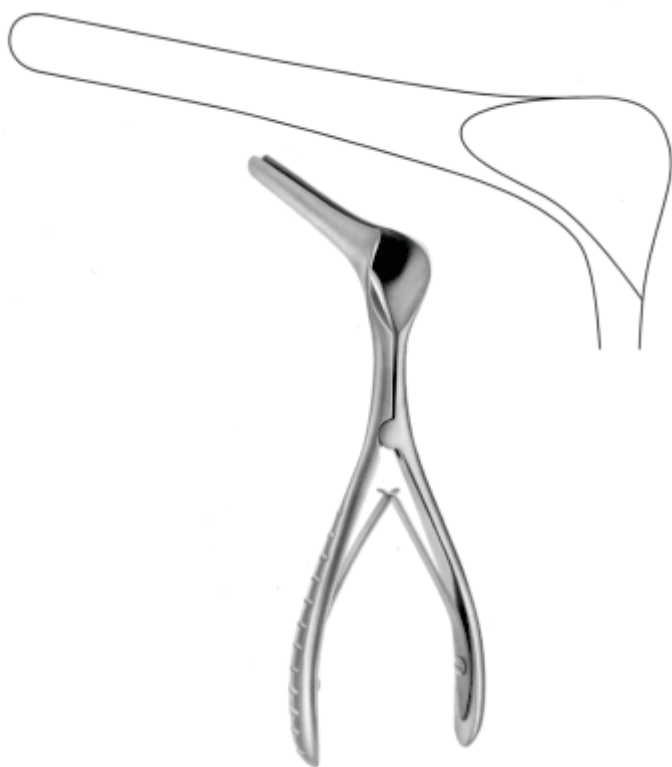

KILLIAN ASEPT NASAL SPECULUM

<u>Item Code</u>	<u>Description</u>
TWS 84-3064/17	#4, 90MM (MODIFIED)



COTTLE NASAL SPECULUM

Item Code	Description
TWS 84-3064/18	#1, 14CM, 35MM
TWS 84-3064/19	#2, 14CM, 55MM
TWS 84-3064/20	#3, 14CM, 75MM
TWS 84-3064/21	#4, 14CM, 90MM



COTTLE NASAL SEPTUM SPECULUM

Item Code	Description
TWS 84-3064/22	14CM, 50MM



COTTLE NASAL SPECULUM

Item Code	Description
TWS 84-3064/23	DELICATE, 15CM, 55MM

RHINOPLASTY KNIVES



TW Surgical



COTTLE NASAL KNIFE

Item Code	Description
<u>TWS 84-3064/24</u>	<u>14CM, STRAIGHT</u>



JOSEPH NASAL KNIFE

Item Code	Description
<u>TWS 84-3064/25</u>	<u>15CM, STRAIGHT, BUTTON END</u>



CONVERSE RHINOPLASTY KNIFE

Item Code	Description
<u>TWS 84-3064/26</u>	<u>15CM, CURVED, BUTTON END</u>



COTTLE DOUBLE EDGED KNIFE

Item Code	Description
<u>TWS 84-3064/27</u>	<u>15CM, STRAIGHT</u>

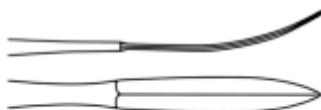

JOSEPH DOUBLE EDGED KNIFE

Item Code	Description
<u>TWS 84-3064/28</u>	<u>15CM, CURVED, SHARP TIP</u>



JOSEPH BUTTON END KNIFE

Item Code	Description
<u>TWS 84-3064/29</u>	<u>16CM, ANGLED</u>



TW Surgical

GRASPING FORCEPS & HOOK SCISSORS

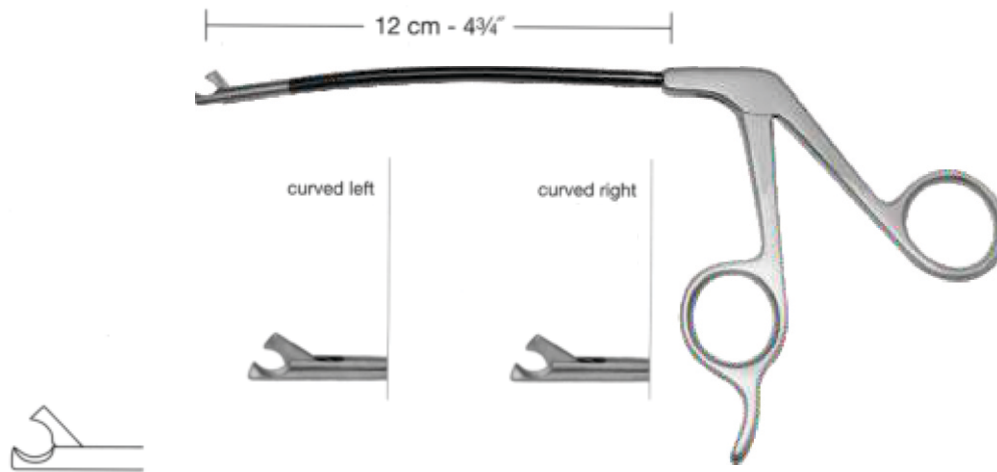

HOOK SCISSORS, 12cm SHAFT

Item Code	Description
<u>TWS 84-3064/30</u>	<u>LEFT</u>
<u>TWS 84-3064/31</u>	<u>RIGHT</u>

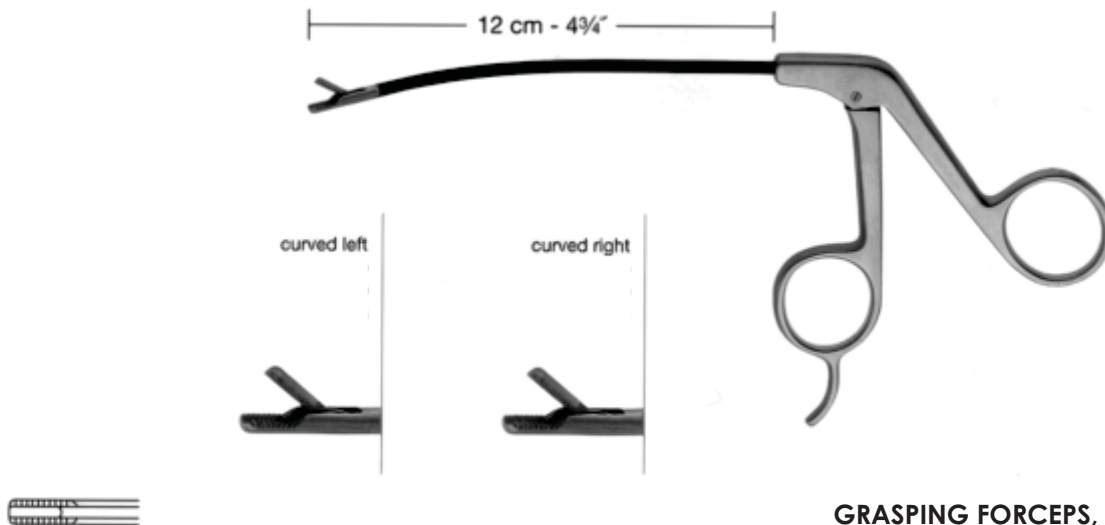

GRASPING FORCEPS, 12cm SHAFT

Item Code	Description
<u>TWS 84-3064/32</u>	<u>LEFT</u>
<u>TWS 84-3064/33</u>	<u>RIGHT</u>

SEPTUM STRAIGHTENING FORCEPS

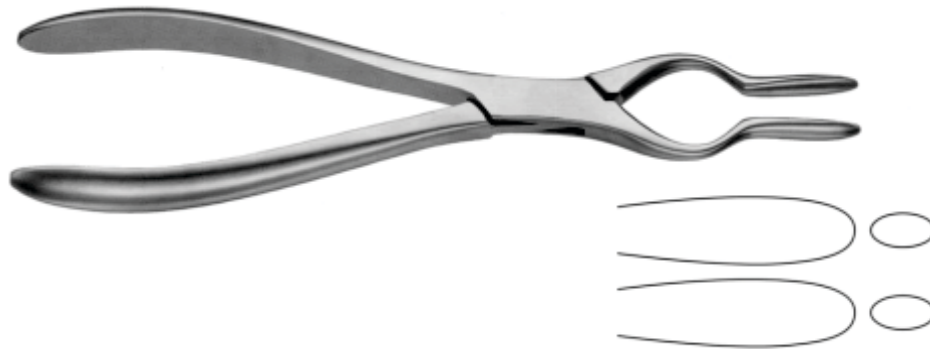

WALSHAM UNIVERSAL SEPTUM FORCEPS

Item Code	Description
<u>TWS 84-3064/34</u>	<u>23CM</u>

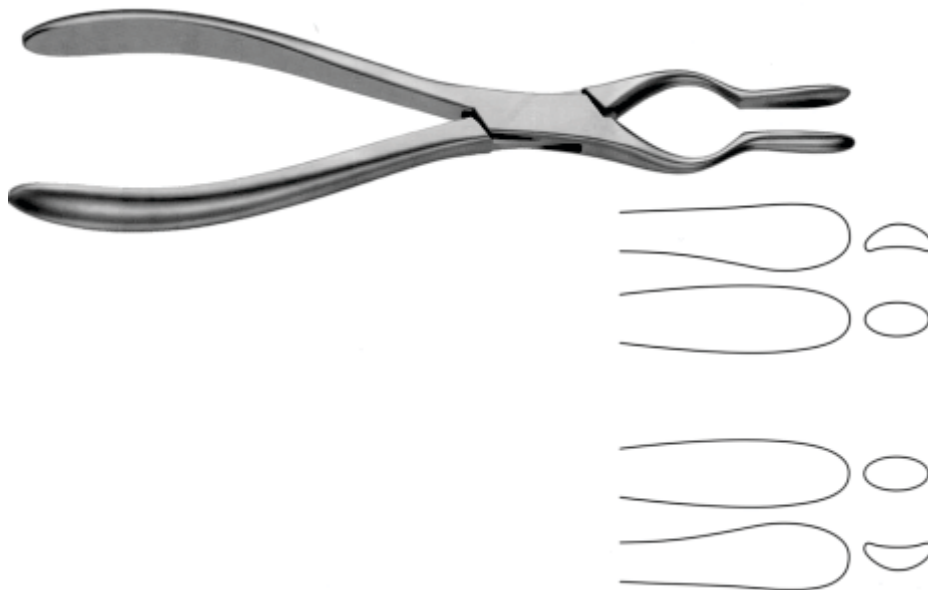

WALSHAM SEPTUM STRAIGHTENING FORCEPS, 23CM

Item Code	Description
<u>TWS 84-3064/35</u>	<u>RIGHT</u>
<u>TWS 84-3064/36</u>	<u>LEFT</u>

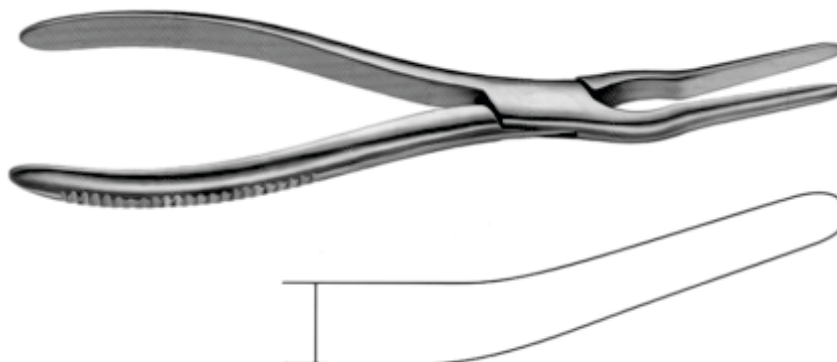

ASCH SEPTUM STRAIGHTENING FORCEPS

Item Code	Description
<u>TWS 84-3064/37</u>	<u>22CM, ANGLED</u>



SEPTUM STRAIGHTENING FORCEPS

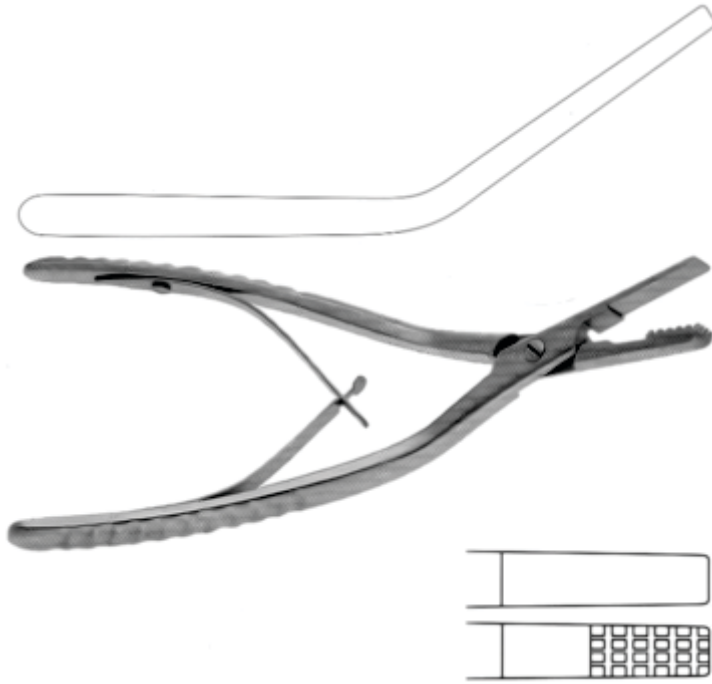

OBWEGESER NASAL SEPTUM CUTTER / PERFORATION FORCEPS

Item Code	Description
TWS 84-3064/38	18.5CM

MOUTH GAGS



TW Surgical



MOLT MOUTH GAG

Item Code	Description
TWS 84-3064/39	10CM, CHILD SIZE
TWS 84-3064/40	5CM, ADULT SIZE



ROSER KOENIG MOUTH GAG

Item Code	Description
TWS 84-3064/41	16CM



DENHART MOUTH GAG

Item Code	Description
TWS 84-3064/42	13CM

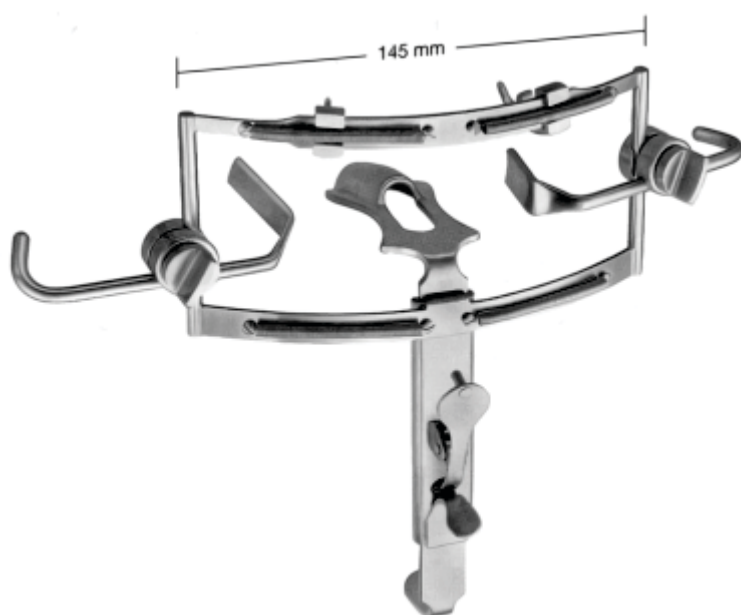

DINGMAN MOUTH GAG

Item Code	Description
TWS 84-3064/43	COMPLETE

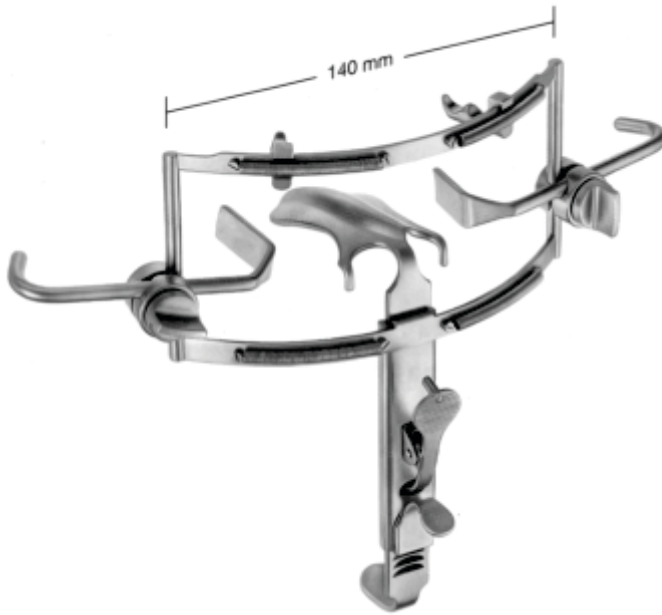

Tongue depressor
Bajalengua
Abaisse-langue
Abbassalingua

55 x 32 mm
Fig.1

60 x 35 mm
Fig.2

75 x 38 mm
Fig.3

WANG MOUTH GAG

Item Code	Description
TWS 84-3064/44	COMPLETE

RAKE RETRACTORS



TW Surgical



YANCOSKIE CORONAL LIFT RETRACTOR

Item Code	Description
TWS 84-3064/45	OFFSET 8½" (216mm) WIDTH 150mm



YANCOSKIE ABDOMINOPLASTY RET.

Item Code	Description
TWS 84-3064/46	OFFSET 7½" (190mm) WIDTH 150mm

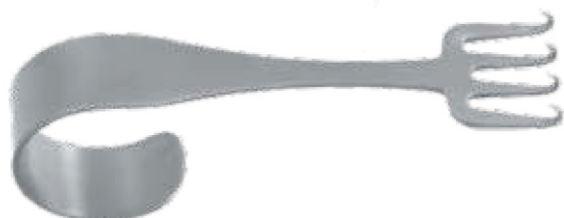

FREEMAN FACE LIFT RETRACTOR

Item Code	Description
TWS 84-3064/47	SMALL FINGER RING, 4" (102mm) WIDTH 21.8mm
TWS 84-3064/48	LARGE FINGER RING, 4¾" (121mm) WIDTH 25mm



TW Surgical

RAKE RETRACTORS



FREEMAN FACE LIFT RETRACTOR

Item Code Description

TWS 84-3064/49 ADAMSON MODEL, 7" (178mm), 37mm



Item Code Description

TWS 84-3064/50 **FREEMAN FLAP RAKE RETRACTOR**
4 1/4" (108mm), 1 1/4" (32mm)



FREEMAN RAKE RETRACTOR

Item Code Description

TWS 84-3064/51 4" (100mm), WIDTH (22mm)

TWS 84-3064/52 4" (100mm), WIDTH (38mm)



GORNEY RAKE RETRACTOR

Item Code Description

TWS 84-3064/53 3" (75mm), WIDTH (38mm)

TWS 84-3064/54 4 1/4" (108mm), WIDTH (38mm)

RETRACTORS



FRAZIER HOOK

Item Code	Description
<u>TWS 84-3064/55</u>	<u>SHARP, 5" (127mm), 5mm</u>
<u>TWS 84-3064/56</u>	<u>BLUNT, 5" (127mm), 5mm</u>



TYRELL HOOK

Item Code	Description
<u>TWS 84-3064/57</u>	<u>SHARP, 5" (127mm), 2mm</u>
<u>TWS 84-3064/58</u>	<u>BLUNT, 5" (127mm), 2mm</u>



KILNER SKIN HOOK

Item Code	Description
<u>TWS 84-3064/59</u>	<u>SHARP, SMOOTH HANDLE, 5" (127mm), 2.5mm</u>



GUTHRIE HOOK

Item Code	Description
<u>TWS 84-3064/60</u>	<u>SHARP, 4³/₄" (121mm), 2.5mm</u>



JOSEPH DOUBLE PRONG HOOK

Item Code	Description
<u>TWS 84-3064/61</u>	<u>SHARP, 6¹/₄" (159mm) , 2mm</u>
<u>TWS 84-3064/62</u>	<u>SHARP, 6¹/₄" (159mm) , 5mm</u>
<u>TWS 84-3064/63</u>	<u>SHARP, 6¹/₄" (159mm) , 7mm</u>
<u>TWS 84-3064/64</u>	<u>SHARP, 6¹/₄" (159mm) , 10mm</u>
<u>TWS 84-3064/65</u>	<u>SHARP, 6¹/₄" (159mm) , 12mm</u>



TW Surgical

RETRACTORS



MAMMAPLASTY OR MASTECTOMY HOOK

Item Code	Description
<u>TWS 84-3064/66</u>	<u>EXTRA LARGE, SHARP, 7½" (191mm), 10mm</u>



FREEMAN SKIN HOOK, 4" (102mm)

Item Code	Description
<u>TWS 84-3064/67</u>	<u>SINGLE SHARP HOOK, 5mm</u>
<u>TWS 84-3064/68</u>	<u>DOUBLE SHARP HOOK, 5mm</u>



CLODIUS FISH HOOK RETRACTOR

Item Code	Description
<u>TWS 84-3064/69</u>	<u>WITH CHAIN, SMALL, 7mm</u>
<u>TWS 84-3064/70</u>	<u>WITH CHAIN, LARGE, 12mm</u>



MILLARD THUMB SINGLE HOOK

Item Code	Description
<u>TWS 84-3064/71</u>	<u>STANDARD, 5mm</u>



MILLARD THUMB DOUBLE HOOK

Item Code	Description
<u>TWS 84-3064/72</u>	<u>STANDARD, 17mm</u>

RETRACTORS



TW Surgical



FREEMAN FLAP RETRACTOR

Item Code	Description
<u>TWS 84-3064/73</u>	<u>8" (203mm) 1/2" (13mm)</u>
<u>TWS 84-3064/74</u>	<u>8" (203mm) 1" (25mm)</u>



FREEMAN FLAP RETRACTOR FIBER OPTIC

Item Code	Description
<u>TWS 84-3064/75</u>	<u>8" (203mm) 1/2" (13mm)</u>
<u>TWS 84-3064/76</u>	<u>8" (203mm) 1" (25mm)</u>



TW Surgical

RETRACTORS

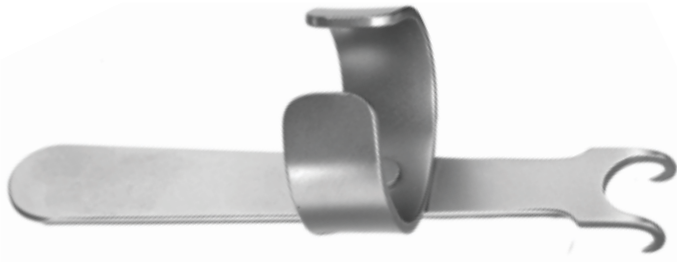

SWIVEL DOUBLE HOOK/RETRACTOR

Item Code	Description
TWS 84-3064/77	2 SHARP PRONG WITH SWIVEL RING 3½" (89mm), 10mm



MARTINEZ-KILNER NASAL RETRACTOR

Item Code	Description
TWS 84-3064/78	2 SHARP PRONGS WITH THUMB RING 4½" (114mm) 7.5mm



SHEEN NASAL RETRACTOR

Item Code	Description
TWS 84-3064/79	ANGLED, 6½" (165mm), 10mm



SHEEN RETRACTOR

Item Code	Description
TWS 84-3064/80	CURVED, 6¼" (159mm), 6.5mm



FARABEUFR RETRACTOR

Item Code	Description
TWS 84-3064/81	STANDARD SET OF 2, 6" (152mm)

RETRACTORS



TW Surgical



U.S. ARMY RETRACTOR, SET OF 2

Item Code	Description
TWS 84-3064/82	8½" (216mm)



DEAVER RETRACTOR,

Item Code	Description
TWS 84-3064/83	12" (305mm), 1" (25mm)



RIBBON RETRACTOR

Item Code	Description
TWS 84-3064/84	INFANT, 6¾" (171mm), 5/8" (16mm)
TWS 84-3064/85	PEDIATRIC, 8" (203mm), 5/8" (16mm)
TWS 84-3064/86	PEDIATRIC, 8" (203mm), 1" (25mm)



MEYERDING FINGER RETRACTOR



Item Code	Description
TWS 84-3064/87	STYLE 1, 7" (178mm), 18mmX7.5mm
TWS 84-3064/88	STYLE 2, 7" (178mm), 16mmX5.5mm
TWS 84-3064/89	STYLE 3, 7" (178mm), 8mmX4.5mm
TWS 84-3064/90	STYLE 4, 7" (178mm), 10mmX3.5mm
TWS 84-3064/91	STYLE 5, 7" (178mm), 8mmX4mm



TW Surgical

RETRACTORS

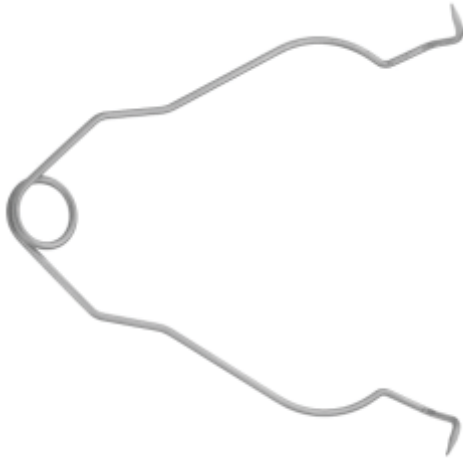

FARR STYLE SPRING RETRACTOR

Item Code	Description
TWS 84-3064/92	SHARP POINTS, 1½" (38mm)
TWS 84-3064/93	SHARP POINTS, 2" (51mm)
TWS 84-3064/94	SHARP POINTS, 2¼" (57mm)
TWS 84-3064/95	SHARP POINTS, 2½" (64mm)
TWS 84-3064/96	SHARP POINTS, 3" (76mm)
TWS 84-3064/97	SHARP POINTS, 2½" (64mm)



ALM SELF-RETRAINING RETRACTOR

Item Code	Description
TWS 84-3064/98	4 X 4 BLUNT PRONGS, 2¾" (70mm)
TWS 84-3064/99	4 X 4 SHARP PRONGS, 2¾" (70mm)
TWS 84-3065/00	4 X 4 BLUNT PRONGS, 4" (102mm)



HOLZHEIMER CROSS-ACTION RETRACTOR

Item Code	Description
TWS 84-3065/01	4 X 4 SHARP PRONGS, 4" (102mm)
TWS 84-3065/02	4 X 4 BLUNT PRONGS, 4" (102mm)



PAPARELLA-WEITLANER RETRACTOR

Item Code	Description
TWS 84-3065/03	2 X 2 SEMI-SHARP PRONGS 5" (127mm), 33mm INSIDE SPREAD

CYLINDER OSTEOTOMES



TW Surgical

Cortical Cutter



SHEPARD CORTICAL CUTTER

Item Code	Description
TWS 84-3065/04	12 cm/ 4¾"

For turning cylinder osteotomes



SHEPARD FOR TURNING CYLINDER

Item Code	Description
TWS 84-3065/05	11 cm/ 4 3/8"



CYLINDER OSTEOTOES, 12.5cm/5"



Item Code	Description
TWS 84-3065/06	Ø5mm
TWS 84-3065/07	Ø6mm
TWS 84-3065/08	Ø8mm

RAM, 14cm/5½"



Item Code	Description
TWS 84-3065/09	Ø5mm
TWS 84-3065/10	Ø6mm
TWS 84-3065/11	Ø8mm

TROCARS 14.5cm/5¾"



Item Code	Description
TWS 84-3065/12	Ø5mm
TWS 84-3065/13	Ø6mm
TWS 84-3065/14	Ø8mm



TW Surgical

AURICULAR PLASTIC INSTRUMENTS



UNIVERSAL T. C. WIRE CUTTING SCISSORS

Item Code	Description
TWS 84-3065/15	12CM



NIROL T.C. WIRE TWISTING FORCEPS

Item Code	Description
TWS 84-3065/16	15CM



NAGATA AURICULAR SEPTUM ELEVATOR

Item Code	Description
TWS 84-3065/17	16CM, BLUNT
TWS 84-3065/18	17CM, BLUNT



DOYEN RIB RASPATORY, 17CM

Item Code	Description
TWS 84-3065/19	RIGHT
TWS 84-3065/20	LEFT

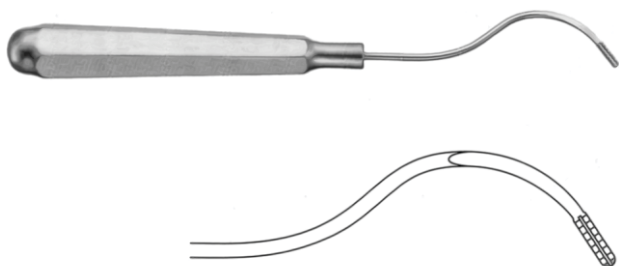

KISTLER ANHELIX CARTILAGE RASP

Item Code	Description
TWS 84-3065/21	RIGHT
TWS 84-3065/22	LEFT



MAYO SCISSORS

Item Code	Description
<u>TWS 84-3065/23</u>	<u>SUPERCUT PLUS T.C.</u>
	<u>(TUNGSTEN CARBIDE) 17CM, CURVED</u>



COTTLE CARTILAGE CRUSHER

Item Code	Description
<u>TWS 84-3065/24</u>	<u>WITH CLAMP, FOR TAKING OUT THE</u>
	<u>PREPARED MATERIAL, 65X30X30MM</u>



CARTILAGE CUTTING BLOCK

Item Code	Description
<u>TWS 84-3065/25</u>	<u>TEFLON, 85X55X10MM</u>



GUBISCH CARTILAGE CRUSHER

Item Code	Description
<u>TWS 84-3065/26</u>	<u>65X30MM</u>



AIACH FORCEPS

Item Code	Description
TWS 84-3065/27	16CM, 5MM TIP



DINGMAN CARTILAGE ABRADERS

Item Code	Description
TWS 84-3065/28	SET OF TWO



RUBIN SEPTAL MORSELIZER FORCEPS

Item Code	Description
TWS 84-3065/29	21CM



RUBIN SEPTAL MORSELIZER FORCEPS

Item Code	Description
TWS 84-3065/30	T.C. (TUNGSTEN CARBIDE) 20CM



BONE MILL

<u>Item Code</u>	<u>Description</u>
<u>TWS 84-3065/31</u>	<u>WITH ASSEMBLING WRENCH</u>



TW Surgical

DERMATOMES



HUMBY DERMATOME KNIFE, ADJUSTABLE

Item Code Description

TWS 84-3065/32 COMPLETE WITH WOODEN BOX, 32CM



Item Code Description

TWS 84-3065/33 SPARE BLADE FOR HUMBY AND WATSON DERMATOME



WATSON DERMATOME

Item Code Description

TWS 84-3065/34 (SKIN GRAFT KNIFE)



SCHINK DERMATOME

Item Code Description

TWS 84-3065/35 30CM, ADJUSTABLE

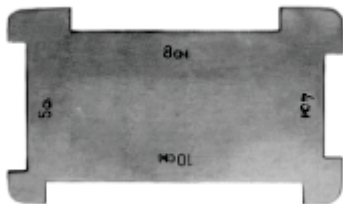

SKIN HOLDING/STRETCHING PLATE

Item Code Description

TWS 84-3065/36 FOR SCHINK DERMATOME



SILVER DERMATOME

Item Code Description

TWS 84-3065/37 19CM, ADJUSTABLE

LIP AND CHEEK RETRACTORS



TW Surgical



LIP RETRACTOR

Item Code	Description
TWS 84-3065/38	FOR UPPER JAW, 21CM



LIP RETRACTOR

Item Code	Description
TWS 84-3065/39	FOR LOWER JAW, 26CM



VESTIBULUM (UNIVERSAL) RETRACTOR

Item Code	Description
TWS 84-3065/40	15CM

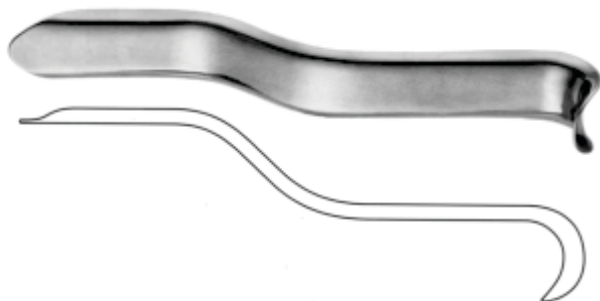

UNIVERSITY OF MINNESOTA CHEEK RETRACTOR

Item Code	Description
TWS 84-3065/41	15.5CM

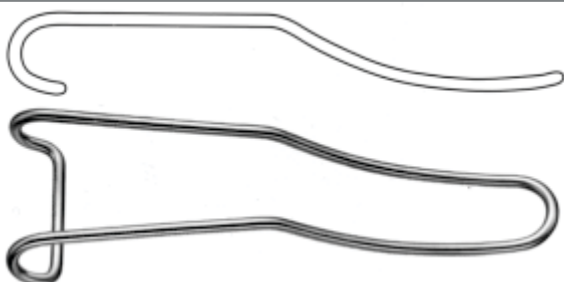

STERNBERG CHEEK RETRACTOR

Item Code	Description
TWS 84-3065/42	14.5CM



TW Surgical

LIP AND CLEFT PALATE INST.



BLOCKSMA CLEFT PALATE HOOK, 18CM

Item Code	Description
TWS 84-3065/43	1 PRONG
TWS 84-3065/44	3MM, 2 PRONG

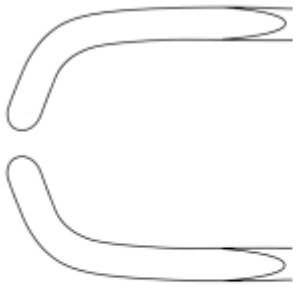

CLEFT PALATE RASPATORY, 14CM

Item Code	Description
TWS 84-3065/45	#1 LEFT
TWS 84-3065/46	#2 RIGHT



KAHRE CLEFT PALATE RASPATORY

Item Code	Description
TWS 84-3065/47	17CM



MCINDOE CLEFT PALATE RASPATORY

Item Code	Description
TWS 84-3065/48	16.5CM

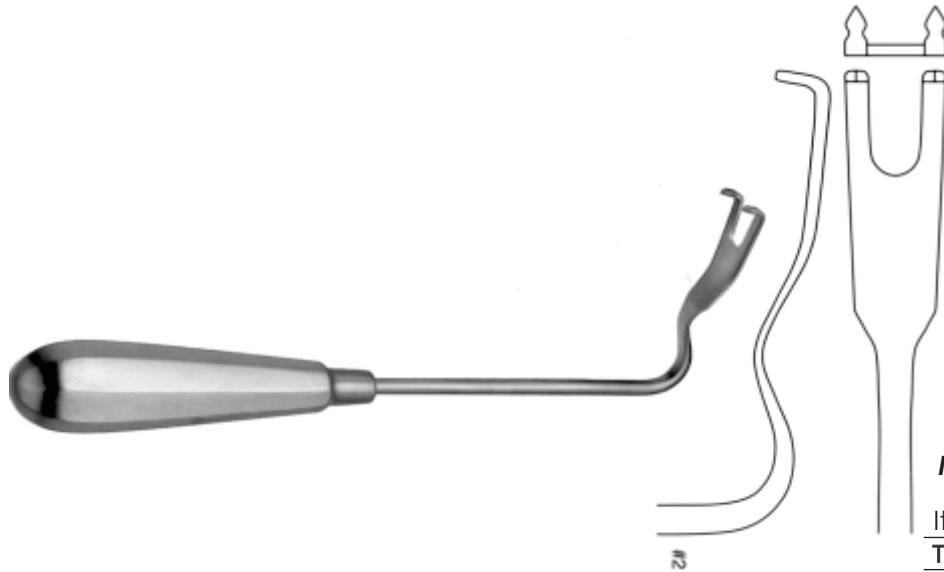

MUCOPERIOSTEAL RETRACTOR

Item Code	Description
TWS 84-3065/49	19CM

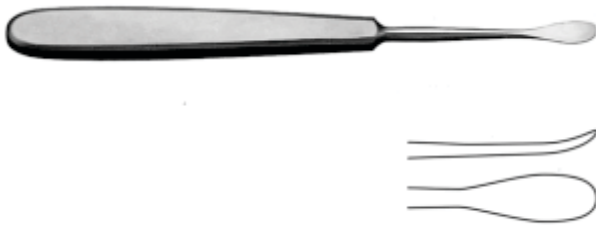

WANG CLEFT PALATE ELEVATOR

Item Code	Description
TWS 84-3065/50	15.5CM

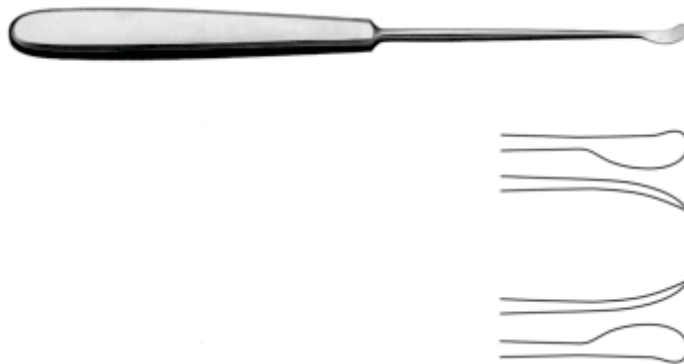

WANG CLEFT PALATE ELEVATOR, 18CM

Item Code	Description
TWS 84-3065/51	RIGHT
TWS 84-3065/52	LEFT
TWS 84-3065/53	RIGHT ANGLED
TWS 84-3065/54	LEFT ANGLED



TW Surgical

MALLETS



MALLET

Item Code	Description
TWS 84-3065/55	18.5CM, PLASTIC FACINGS, 200 GRAMS, 25MM DIAMETER



MALLET, 26CM, NOVOTEX PLASTIC

Item Code	Description
TWS 84-3065/56	150 GRAMS, 35MM DIAMETER
TWS 84-3065/57	240 GRAMS, 45MM DIAMETER
TWS 84-3065/58	330 GRAMS, 50MM DIAMETER



COTTLE MALLET, 19CM

Item Code	Description
TWS 84-3065/59	1 PLAIN FACE, 1 CONVEX FACE



QUILLEN METAL HAMMER, 24CM

Item Code	Description
TWS 84-3065/60	300 GRAMS, 30MMØ, ANGLED FACES

Treasure Wright (U.K.) Ltd.

128-160 City Road, London, EC1V 2NX, United Kingdom
info@twrightmedical.com

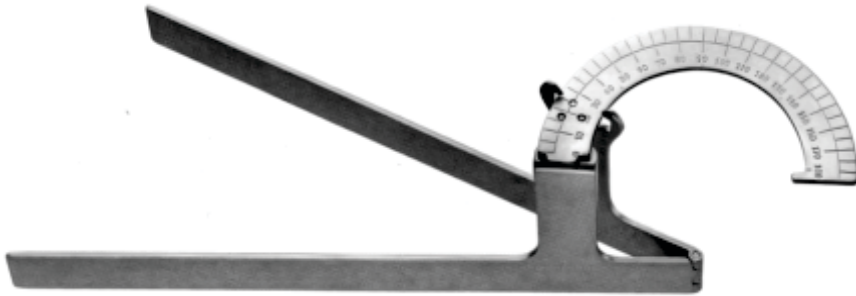

MOLTGEN FLEXOMETER

Item Code Description
TWS 84-3065/61 24CM



FINGER GONIOMETER

Item Code Description
TWS 84-3065/62 13CM



KNOCHEN MESSZIRKEL BONE BOW SPACER

Item Code Description
TWS 84-3065/63 19.5CM, SHARP TIPS

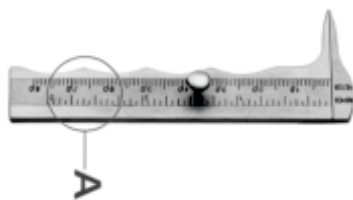

JAMESON CALIPER

Item Code Description
TWS 84-3065/64 10CM



THORPE CALIPER, 11CM

Item Code Description
TWS 84-3065/65 80MM MEASURING RANGE



TW Surgical

MARKING AND MEASURING INST.



CASTROVIEJO CALIPER, 8CM

Item Code	Description
TWS 84-3065/66	20MM MEASURING RANGE



CASTROVIEJO CALIPER, 9CM

Item Code	Description
TWS 84-3065/67	40MM MEASURING RANGE



CASTROVIEJO EPKER CALIPER, 18CM

Item Code	Description
TWS 84-3065/68	STRAIGHT, 40MM MEASURING RANGE



CASTROVIEJO EPKER CALIPER, 18CM

Item Code	Description
TWS 84-3065/69	ANGLED, 40MM MEASURING RANGE

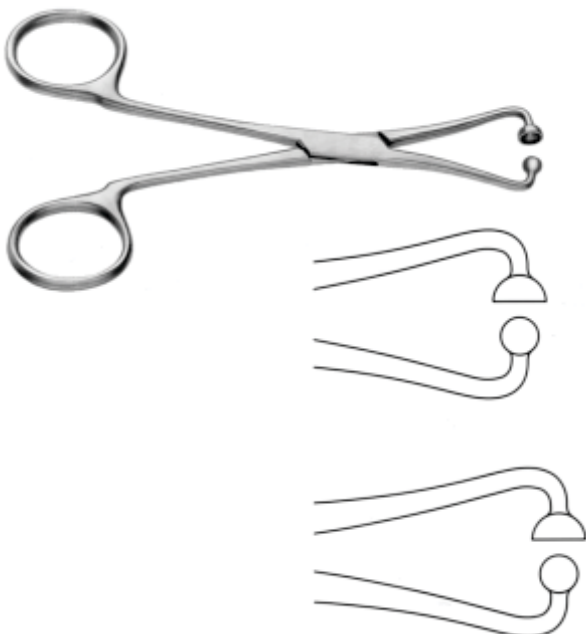

NOSE TIP MARKER

Item Code	Description
TWS 84-3065/70	12CM, STRAIGHT
TWS 84-3065/71	14.5CM, STRAIGHT



JOSEPH MEASURING ROD, 17CM

Item Code	Description
TWS 84-3065/72	GRADUATED IN MILLIMETERS

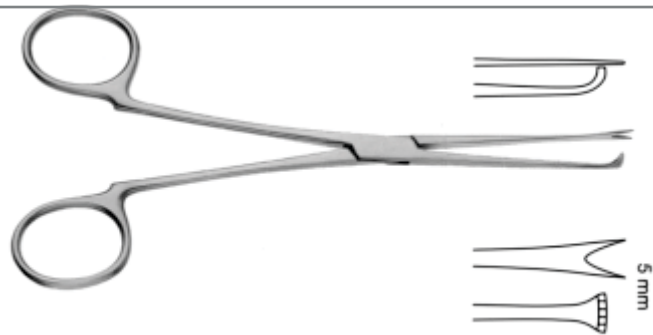

PITANGUY FACELIFT MARKER, 16CM

Item Code	Description
TWS 84-3065/73	5MM WIDE



MARTEN FLAP MARKER, 5 3/4" (14.5 CM)

Item Code	Description
TWS 84-3065/74	WITH RATCHET
TWS 84-3065/75	WITHOUT RATCHET



D ASSUMPCAO ABDOMINAL FLAP MARKER

Item Code	Description
TWS 84-3065/76	10 MM WIDTH, 10" (254 MM) LENGTH



LOCKWOOD ABDOMINAL DEMARCATOR

Item Code	Description
TWS 84-3065/77	11 MM WIDTH, WITH ANGLED HINGE, 12 1/4" (311 MM) LENGTH



TW Surgical

MARKING AND MEASURING INST. MAXILLA MOBILIZER

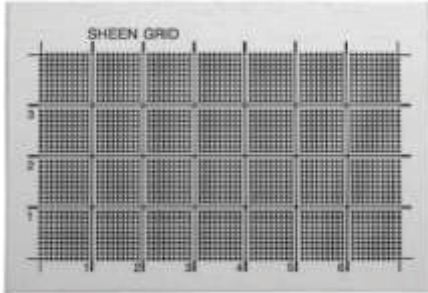

Sheen Grid Stainless Steel

Item Code	Description
TWS 84-3065/78	Autoclavable, Grid Dimensions are 40 X 70 mm



NAVAL MARKER

Item Code	Description
TWS 84-3065/79	11 3/8" (29cm)

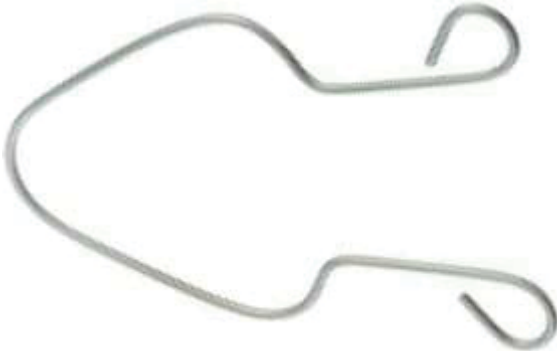

ACKERMAN BREAST MARKER

Item Code	Description
TWS 84-3065/80	5 1/2" (14 CM), SMALL
TWS 84-3065/81	6 1/4" (16 CM), LARGE



MCKISSOCK KEYHOLE PATTERN

Item Code	Description
TWS 84-3065/82	38 MM DIAMETER, WITH CM MARKINGS
TWS 84-3065/83	42 MM DIAMETER, WITH CM MARKINGS
TWS 84-3065/84	45 MM, DIAMETER, WITH CM MARKINGS



OBWEGESER MAXILLA MOBILIZING INSTRUMENT

Item Code	Description
TWS 84-3065/85	23CM, 12MM

BONE INSTRUMENTS



TW Surgical

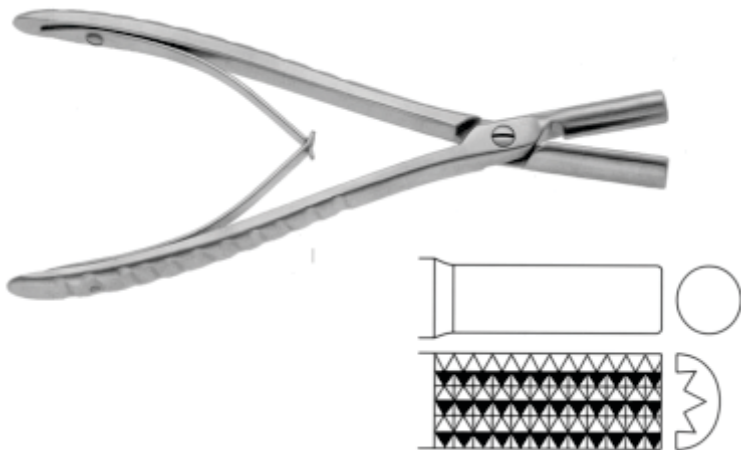

OBWEGESER, BONE BENDING PLIERS

Item Code Description
TWS 84-3065/86 17.5cm/7"

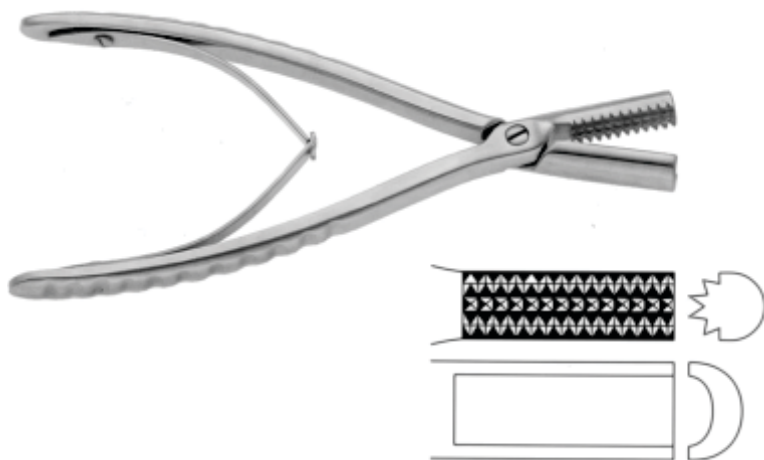

OBWEGESER, BONE BENDING PLIERS

Item Code Description
TWS 84-3065/87 17.5cm/7"

Septal Morslizer Forceps
with protective guard

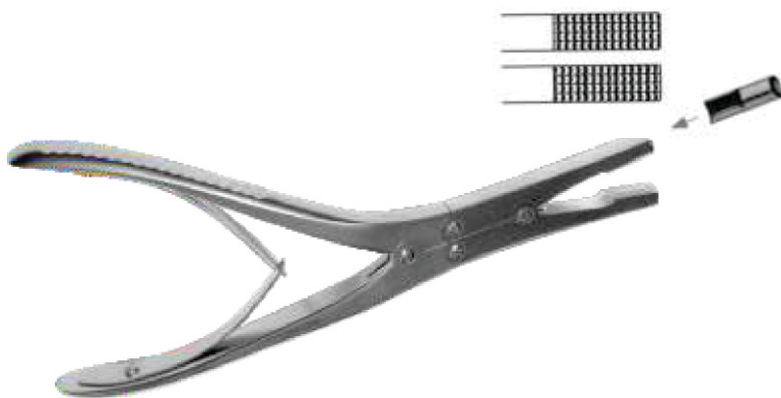

RUBIN FORCEPS

Item Code Description
TWS 84-3065/88 20cm/8"

Treasure Wright (U.K.) Ltd.

128-160 City Road, London, EC1V 2NX, United Kingdom
info@twrightmedical.com

SCALPEL HANDLE



TW Surgical



SCALPEL HANDLE, NO.3

Item Code	Description
TWS 84-3065/89	12.5cm/5"



SCALPEL HANDLE, NO.7

Item Code	Description
TWS 84-3065/90	16.5cm/6½"



SCALPEL HANDLE, NO.7K

Item Code	Description
TWS 84-3065/91	12cm/4¾"



SCALPEL HANDLE, NO.3L

Item Code	Description
TWS 84-3065/92	21cm/8¼"



SCALPEL HANDLE, NO.3LA

Item Code	Description
TWS 84-3065/93	20.5cm/8"



ROUND SCALPEL HANDLE

Item Code	Description
TWS 84-3065/94	15.5cm/6 1/8"



TW Surgical

SCISSORS

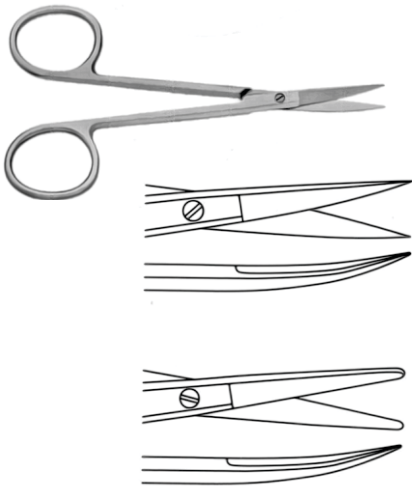

COTTLE MASING RHINOPLASTY SCISSORS, 10CM, CURVED BLADE

Item Code	Description
<u>TWS 84-3065/95</u>	<u>SHARP</u>
<u>TWS 84-3065/96</u>	<u>BLUNT</u>



COTTLE BULLDOG SCISSORS

Item Code	Description
<u>TWS 84-3065/97</u>	<u>11.5CM</u>

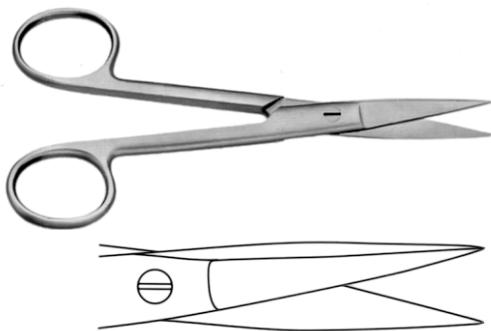

CONVERSE SCISSORS

Item Code	Description
<u>TWS 84-3065/98</u>	<u>13.5CM, DOUBLE EDGED, OUTER EDGES SEMI SHARP</u>

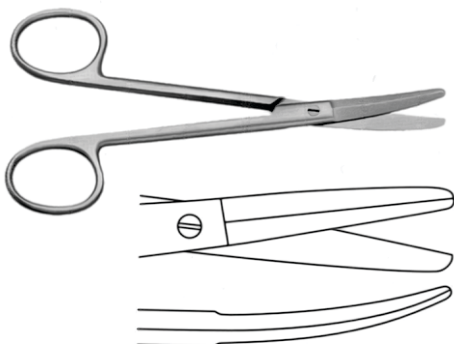

FOMON RHINOPLASTY SCISSORS, 12.5CM

Item Code	Description
<u>TWS 84-3065/99</u>	<u>WITH OUTER CUTTING, BOTH SIDES SHARP</u>

SCISSORS



TW Surgical

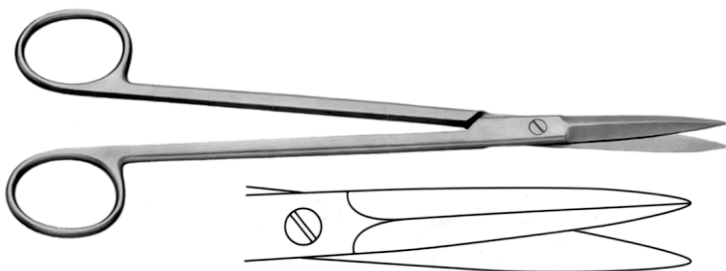

MCINDOE RHINOPLASTY SCISSORS

Item Code	Description
TWS 84-3066/00	19CM, STRAIGHT, SERRATED

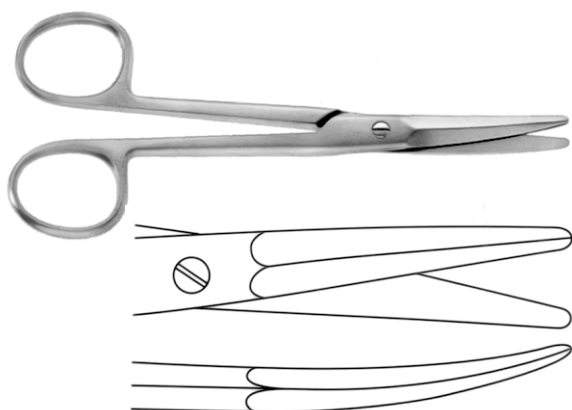

AUFRICHT NASAL SCISSORS, 14CM, BLUNT

STANDARD	SUPERCUT	TC	SUPERCUT PLUS
TWS 84-3066/01	TWS 84-3066/02	TWS 84-3066/03	TWS 84-3066/04



GIUNTA T.C. NASAL SCISSORS

Item Code	Description
TWS 84-3066/05	13.5CM, CURVED

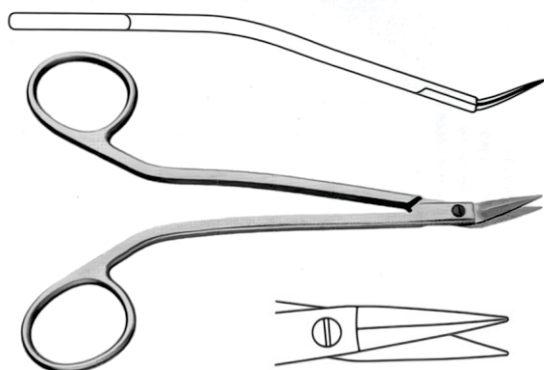

WALTER DORSAL SCISSORS 14CM, ANGULAR

STANDARD	SUPERCUT	TC	SUPERCUT PLUS
TWS 84-3066/06	TWS 84-3066/07	TWS 84-3066/08	TWS 84-3066/09



TW Surgical

SCISSORS

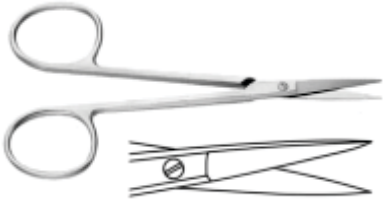

IRIS SCISSORS, STRAIGHT

	STANDARD	SUPERCUT	TC	SUPERCUT PLUS
3½" (9cm)	TWS 84-3066/10	TWS 84-3066/14	TWS 84-3066/18	TWS 84-3066/22
4¼" (10.5cm)	TWS 84-3066/11	TWS 84-3066/15	TWS 84-3066/19	TWS 84-3066/23
4½" (11.5cm)	TWS 84-3066/12	TWS 84-3066/16	TWS 84-3066/20	TWS 84-3066/24
5" (12.5cm)	TWS 84-3066/13	TWS 84-3066/17	TWS 84-3066/21	TWS 84-3066/25



IRIS SCISSORS, CURVED

	STANDARD	SUPERCUT	TC	SUPERCUT PLUS
3½" (9cm)	TWS 84-3066/26	TWS 84-3066/30	TWS 84-3066/34	TWS 84-3066/38
4¼" (10.5cm)	TWS 84-3066/27	TWS 84-3066/31	TWS 84-3066/35	TWS 84-3066/39
4½" (11.5cm)	TWS 84-3066/28	TWS 84-3066/32	TWS 84-3066/36	TWS 84-3066/40
5" (12.5cm)	TWS 84-3066/29	TWS 84-3066/33	TWS 84-3066/37	TWS 84-3066/41

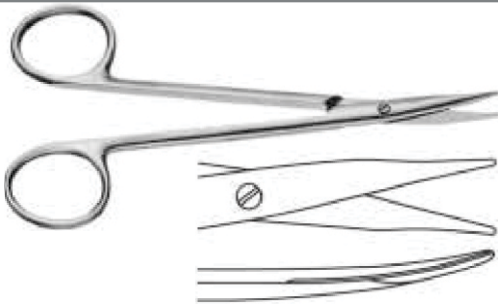

STEVEN SCISSORS, 5 1/8" (13cm)

STANDARD	SUPERCUT
TWS 84-3066/42	TWS 84-3066/43



MAYO SCISSORS, STRIAGHT

	STANDARD	SUPERCUT	TC	SUPERCUT PLUS
14 cm	TWS 84-3066/44	TWS 84-3066/46	TWS 84-3066/48	TWS 84-3066/50
17 cm	TWS 84-3066/45	TWS 84-3066/47	TWS 84-3066/49	TWS 84-3066/51

MAYO SCISSORS, STRIAGHT

	STANDARD	SUPERCUT	TC	SUPERCUT PLUS
14 cm	TWS 84-3066/52	TWS 84-3066/54	TWS 84-3066/56	TWS 84-3066/58
17 cm	TWS 84-3066/53	TWS 84-3066/55	TWS 84-3066/57	TWS 84-3066/59

Treasure Wright (U.K.) Ltd.

128-160 City Road, London, EC1V 2NX, United Kingdom
info@twrightmedical.com

SCISSORS



MAYO STILLE SCISSORS

	STANDARD	SUPERCUT	TC	SUPERCUT PLUS
15 cm	TWS 84-3066/60	TWS 84-3066/62	TWS 84-3066/64	TWS 84-3066/66
17 cm	TWS 84-3066/61	TWS 84-3066/63	TWS 84-3066/65	TWS 84-3066/67



METZENBAUM SCISSORS

	STANDARD	SUPERCUT	TC	SUPERCUT PLUS
14 cm	TWS 84-3066/68	TWS 84-3066/71	TWS 84-3066/74	TWS 84-3066/77
18 cm	TWS 84-3066/69	TWS 84-3066/72	TWS 84-3066/75	TWS 84-3066/78
20 cm	TWS 84-3066/70	TWS 84-3066/73	TWS 84-3066/76	TWS 84-3066/79



NELSON METZENBAUM SCISSORS

	STANDARD	SUPERCUT	TC	SUPERCUT PLUS
23 cm	TWS 84-3066/80	TWS 84-3066/83	TWS 84-3066/86	TWS 84-3066/89
26 cm	TWS 84-3066/81	TWS 84-3066/84	TWS 84-3066/87	TWS 84-3066/90
30 cm	TWS 84-3066/82	TWS 84-3066/85	TWS 84-3066/88	TWS 84-3066/91



TW Surgical

SCISSORS



FANOUS SCISSORS

	STRIAGHT STANDARD	STRIAGHT SUPERCUT	CURVED STANDARD	CURVED SUPERCUT
16.5 cm	TWS 84-3066/92	TWS 84-3066/94	TWS 84-3066/96	TWS 84-3066/98
20.5 cm	TWS 84-3066/93	TWS 84-3066/95	TWS 84-3066/97	TWS 84-3066/99



GORNEY SCISSORS

	STANDARD	SUPERCUT	TC	SUPERCUT PLUS
17 cm	TWS 84-3067/00	TWS 84-3067/03	TWS 84-3067/06	TWS 84-3067/09
19 cm	TWS 84-3067/01	TWS 84-3067/04	TWS 84-3067/07	TWS 84-3067/10
23 cm	TWS 84-3067/02	TWS 84-3067/05	TWS 84-3067/08	TWS 84-3067/11

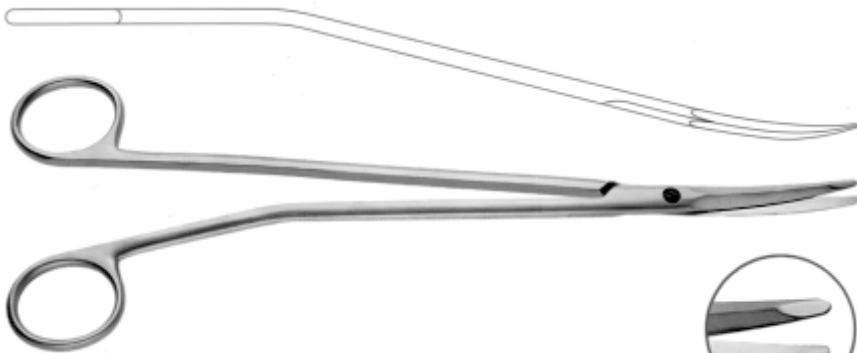

GORNEY FREEMAN SCISSORS

	STANDARD	SUPERCUT	TC	SUPERCUT PLUS
23 cm	TWS 84-3067/12	TWS 84-3067/13	TWS 84-3067/14	TWS 84-3067/15

Treasure Wright (U.K.) Ltd.

128-160 City Road, London, EC1V 2NX, United Kingdom
info@twrightmedical.com

SCISSORS

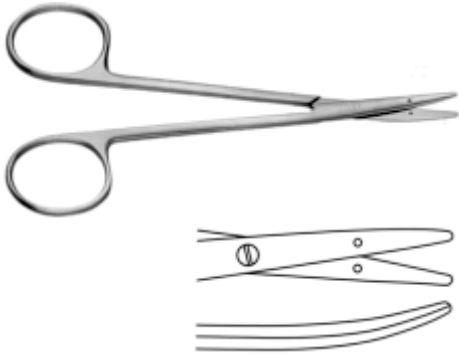

LITTLER SCISSORS,

Item Code	Description
TWS 84-3067/16	STANDARD, 4 ³ / ₄ " (12cm)

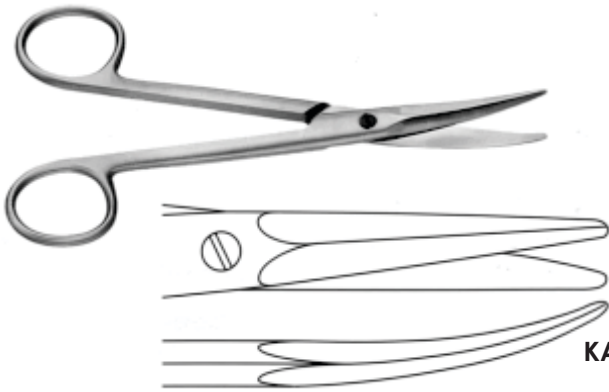

KAYE SCISSORS

	STANDARD	SUPERCUT	TC	SUPERCUT PLUS
15 cm	TWS 84-3067/17	TWS 84-3067/19	TWS 84-3067/21	TWS 84-3067/23
17 cm	TWS 84-3067/18	TWS 84-3067/20	TWS 84-3067/22	TWS 84-3067/24

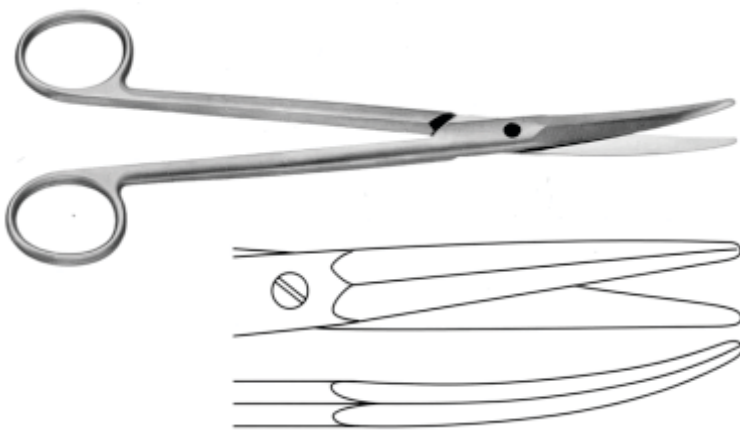

KAYE SCISSORS

	STANDARD	SUPERCUT	TC	SUPERCUT PLUS
19 cm	TWS 84-3067/25	TWS 84-3067/27	TWS 84-3067/29	TWS 84-3067/31
23 cm	TWS 84-3067/26	TWS 84-3067/28	TWS 84-3067/30	TWS 84-3067/32



TW Surgical

SCISSORS



BLEPHAROPLASTY SCISSORS

Item Code	Description
TWS 84-3067/33	SUPERCUT, 4½" (11.5cm)

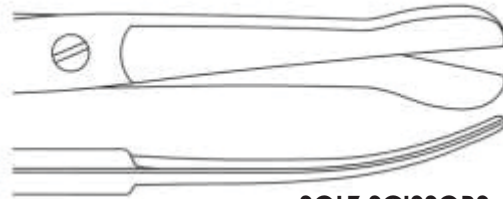

SOLZ SCISSORS

	STANDARD	SUPERCUT	TC	SUPERCUT PLUS
20 cm	TWS 84-3067/34	TWS 84-3067/35	TWS 84-3067/36	TWS 84-3067/37



SOLZ SCISSORS

	STANDARD	SUPERCUT	TC	SUPERCUT PLUS
20 cm	TWS 84-3067/38	TWS 84-3067/39	TWS 84-3067/40	TWS 84-3067/41

Treasure Wright (U.K.) Ltd.

128-160 City Road, London, EC1V 2NX, United Kingdom
info@twrightmedical.com

SCISSORS

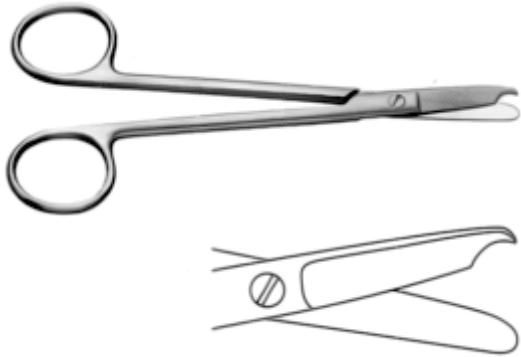

LITTAUER SCISSORS

Item Code	Description
TWS 84-3067/42	5 1/8" (13cm)

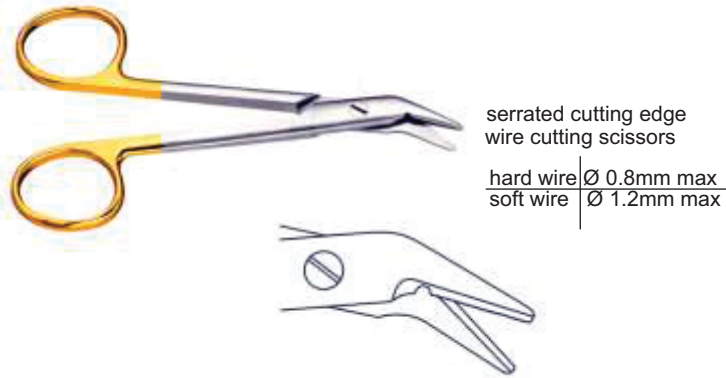

UNIVERSAL SCISSORS

Item Code	Description
TWS 84-3067/43	4 3/4" (12cm)



DEAN SCISSORS

	STANDARD	SUPERCUT
17 cm	TWS 84-3067/44	TWS 84-3067/45

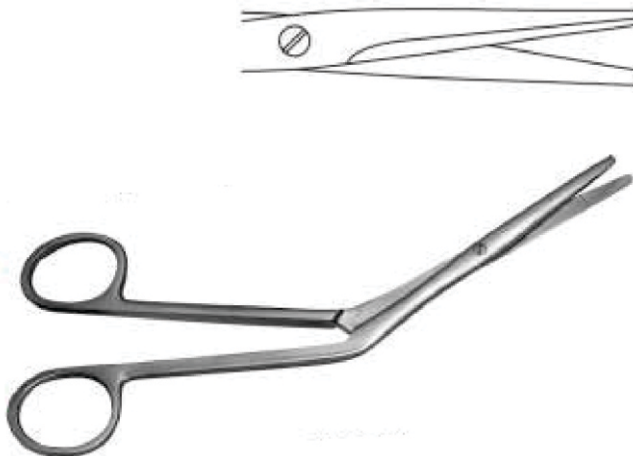

HEYMANN SCISSORS

	STANDARD	SUPERCUT
17 cm	TWS 84-3067/46	TWS 84-3067/47



TW Surgical

SCISSORS

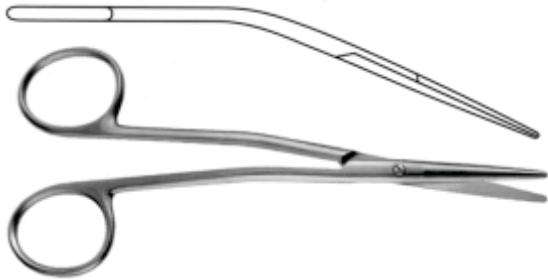

FOMON SCISSORS

	STANDARD	SUPERCUT	TC	SUPERCUT PLUS
13 cm	TWS 84-3067/48	TWS 84-3067/49	TWS 84-3067/50	TWS 84-3067/51



WALTER SCISSORS

	STANDARD	SUPERCUT
14 cm	TWS 84-3067/52	TWS 84-3067/53

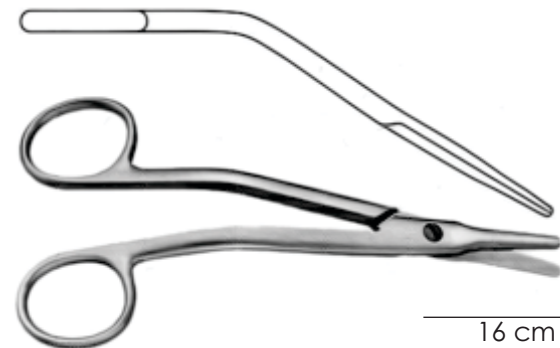

WALTER COTTLE SCISSORS

	STANDARD	SUPERCUT	TC	SUPERCUT PLUS
16 cm	TWS 84-3067/54	TWS 84-3067/55	TWS 84-3067/56	TWS 84-3067/57

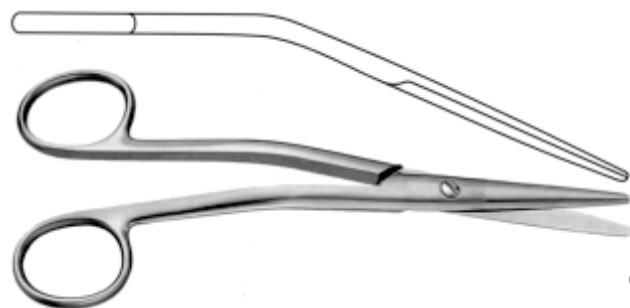

COTTLE SCISSORS

	STANDARD	SUPERCUT	TC	SUPERCUT PLUS
16 cm	TWS 84-3067/58	TWS 84-3067/59	TWS 84-3067/60	TWS 84-3067/61

SCISSORS

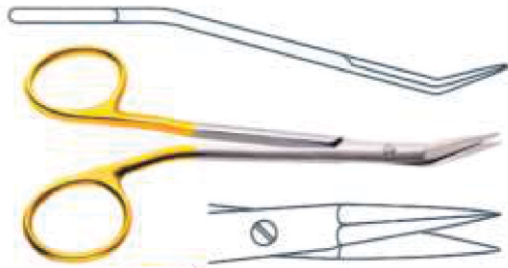

GIUNTA SCISSORS

	STANDARD	SUPERCUT	TC	SUPERCUT PLUS
13.5 cm	TWS 84-3067/62	TWS 84-3067/63	TWS 84-3067/64	TWS 84-3067/65



outer edges
semi sharp

CONVERSE SCISSORS

	STANDARD	SUPERCUT	TC	SUPERCUT PLUS
13.5 cm	TWS 84-3067/66	TWS 84-3067/67	TWS 84-3067/68	TWS 84-3067/69



COTTLE MASING SCISSORS, 10 CM

	STANDARD
SHARP	TWS 84-3067/70
BLUNT	TWS 84-3067/71



Bulldog Scissors

COTTLE SCISSORS, 11.5 CM

	STANDARD
11.5 cm	TWS 84-3067/72



TW Surgical

SCISSORS

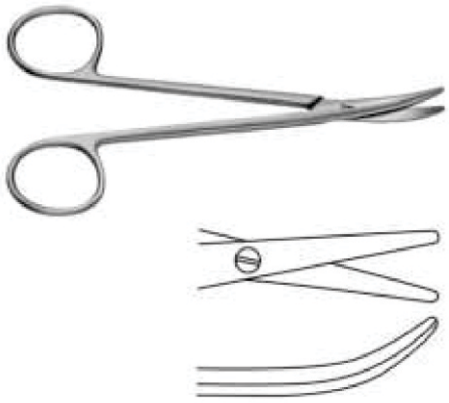

CINELLI SCISSORS

	STANDARD
11 cm	TWS 84-3067/73



with outer cutting,
both sides sharp

FOMON SCISSORS

	STANDARD
12.5 cm	TWS 84-3067/74



serrated cutting edge



Nasal Septum Scissors

CAPLAN SCISSORS

Item Code	Description
TWS 84-3067/75	20cm/ 8"

DRESSING & TISSUE FORCEPS



TW Surgical



TISSUE FORCEPS

Item Code	Description
TWS 84-3067/76	14.5cm/5 3/4"



ADSON FORCEPS

Item Code	Description
TWS 84-3067/77	12cm/4 3/4"



ADSON FORCEPS,TC

Item Code	Description
TWS 84-3067/78	12cm/4 3/4"



ADSON FORCEPS,TC

Item Code	Description
TWS 84-3067/79	15cm/6"



HUDSON-EWALD FORCEPS

Item Code	Description
TWS 84-3067/80	SERRATED, 12cm/4 3/4"



HUDSON-EWALD FORCEPS

Item Code	Description
TWS 84-3067/81	1X2 TEETH, 12cm/4 3/4"



ADSON FORCEPS

Item Code	Description
TWS 84-3067/82	1X2 TEETH, 15cm/6"



TW Surgical

DRESSING & TISSUE FORCEPS



ADSON FORCEPS, TC

Item Code	Description
TWS 84-3067/83	1X2 TEETH, 12cm/4 ³ / ₄ "



ADSON FORCEPS, TC

Item Code	Description
TWS 84-3067/84	1X2 TEETH, 15cm/6"



ADSON BROWN FORCEPS, 12cm/4³/₄"

Item Code	Description
TWS 84-3067/85	7X7 TEETH
TWS 84-3067/86	9X9 TEETH



ADSON BROWN FORCEPS

Item Code	Description
TWS 84-3067/87	12cm/ 4 ³ / ₄ "



ADSON GRAEFE BROWN FORCEPS

Item Code	Description
TWS 84-3067/88	12cm/ 4 ³ / ₄ "



SEMKEN FORCEPS

Item Code	Description
TWS 84-3067/89	12.5cm/ 5"

Treasure Wright (U.K.) Ltd.

128-160 City Road, London, EC1V 2NX, United Kingdom
info@twrightmedical.com

DRESSING & TISSUE FORCEPS

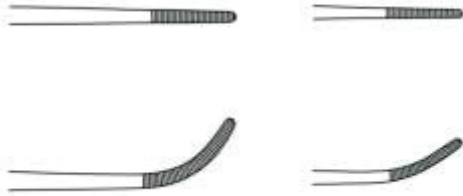

SEMKEN FORCEPS

Item Code	Description
TWS 84-3067/90	SERRATED, STRAIGHT, 12.5cm/5"
TWS 84-3067/91	SERRATED, CURVED, 12.5cm/5"
TWS 84-3067/92	SERRATED, STRAIGHT, 15cm/6"
TWS 84-3067/93	SERRATED, CURVED, 15cm/6"

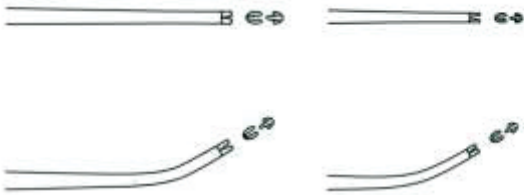

SEMKEN FORCEPS

Item Code	Description
TWS 84-3067/94	1X2 TEETH, STRAIGHT, 12.5cm/5"
TWS 84-3067/95	1X2 TEETH, CURVED, 12.5cm/5"
TWS 84-3067/96	1X2 TEETH, STRAIGHT, 15cm/6"
TWS 84-3067/97	1X2 TEETH, CURVED, 15cm/6"



MCINDOE FORCEPS

Item Code	Description
TWS 84-3067/98	SERRATED, 15cm/6"



GILLIES FORCEPS

Item Code	Description
TWS 84-3067/99	SERRATED, 1X2 TEETH, 15cm/6"



WAUGH FORCEPS

Item Code	Description
TWS 84-3068/00	CROSS SERRATION, 15cm/6"
TWS 84-3068/01	CROSS SERRATION, 1X2 TEETH, 15cm/6"



TW Surgical

DRESSING & TISSUE FORCEPS



Item Code	Description
TWS 84-3068/02	FORCEPS, SERRATED, 20cm/8"



DEBAKEY "AT" FORCEPS

Item Code	Description
TWS 84-3068/03	15cm/6"

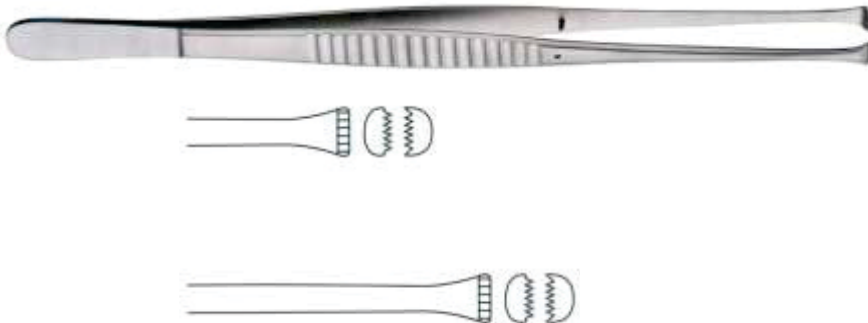

NELSON FORCEPS

Item Code	Description
TWS 84-3068/04	15cm/6"
TWS 84-3068/05	23cm/9"



WALTER FORCEPS

Item Code	Description
TWS 84-3068/06	16m/6¼"



WALTER FORCEPS

Item Code	Description
TWS 84-3068/07	16m/6¼"

DRESSING & TISSUE FORCEPS



TW Surgical



Bayonet Forceps

GRUENWALD FORCEPS

Item Code	Description
TWS 84-3068/08	16 cm/ 6¼"



TROELTSCH (WILDE) FORCEPS

Item Code	Description
TWS 84-3068/09	13 cm/ 5 1/8"



Lip Grasping Forceps

WALTER FORCEPS

Item Code	Description
TWS 84-3068/10	8 cm/ 3 1/8"

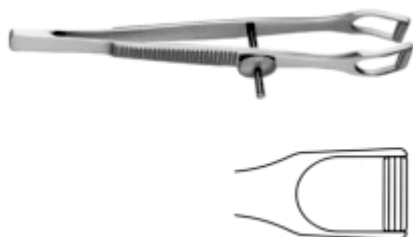

COTTLE FORCEPS

Item Code	Description
TWS 84-3068/11	15 cm/ 6"



with catch

FOX FORCEPS

Item Code	Description
TWS 84-3068/12	15 cm/ 6"



TW Surgical

HEMOSTATIC FORCEPS



HALSTED MOSQUITO FORCEPS

Item Code	Description
TWS 84-3068/13	STRAIGHT 12.5cm/5"
TWS 84-3068/14	CURVED 12.5cm/5"

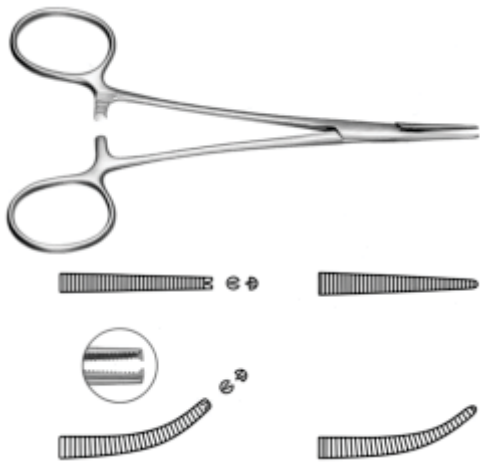

MICRO MOSQUITO FORCEPS

Item Code	Description
TWS 84-3068/15	STRAIGHT 12.5cm/5"
TWS 84-3068/16	CURVED 12.5cm/5"
TWS 84-3068/17	STRAIGHT, 1X2 TEETH, 12.5cm/5"
TWS 84-3068/18	CURVED, 1X2 TEETH, 12.5cm/5"

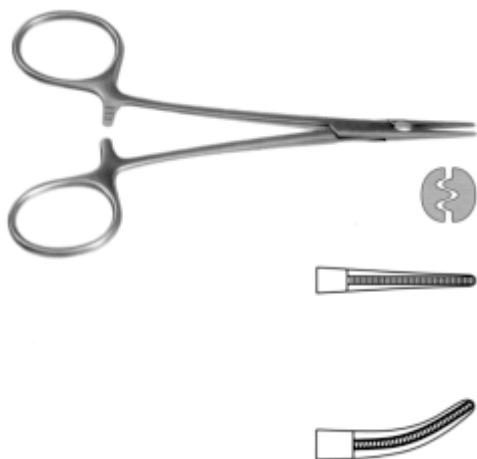

Atraumatic Serration

MOSQUITO "AT" FORCEPS

Item Code	Description
TWS 84-3068/19	STRAIGHT 12.5cm/5"
TWS 84-3068/20	CURVED 12.5cm/5"

HEMOSTATIC FORCEPS



TW Surgical



MICRO JACOBSON FORCEPS

Item Code	Description
TWS 84-3068/21	STRAIGHT 12.5cm/5"
TWS 84-3068/22	CURVED 12.5cm/5"



MICRO JACOBSON FORCEPS

Item Code	Description
TWS 84-3068/23	STRAIGHT 12.5cm/5"
TWS 84-3068/24	CURVED 12.5cm/5"

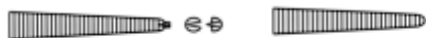

HALSTED MOSQUITO FORCEPS

Item Code	Description
TWS 84-3068/25	STRAIGHT 10cm/4"
TWS 84-3068/26	CURVED 10cm/4"
TWS 84-3068/27	STRAIGHT, 1X2 TEETH, 12.5cm/5"
TWS 84-3068/28	CURVED, 1X2 TEETH, 12.5cm/5"



TW Surgical

HEMOSTATIC FORCEPS



PROVIDENCE HOSPITAL FORCEPS, 14cm/5½"

Item Code	Description
TWS 84-3068/29	STRAIGHT
TWS 84-3068/30	CURVED,
TWS 84-3068/31	STRAIGHT, 1X2 TEETH
TWS 84-3068/32	CURVED, 1X2 TEETH

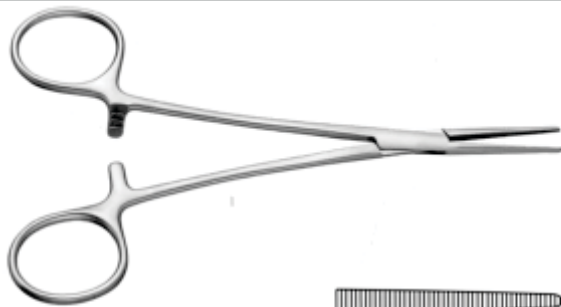

LERICHE FORCEPS, 15cm/ 6"

Item Code	Description
TWS 84-3068/33	STRAIGHT
TWS 84-3068/34	CURVED
TWS 84-3068/35	STRAIGHT, 1X2 TEETH
TWS 84-3068/36	CURVED, 1X2 TEETH

Treasure Wright (U.K.) Ltd.

128-160 City Road, London, EC1V 2NX, United Kingdom
info@twrightmedical.com

NEEDLE HOLDERS



COLLIER NEEDLE HOLDER

Item Code Description
TWS 84-3068/37 13 cm/ 5 1/8"

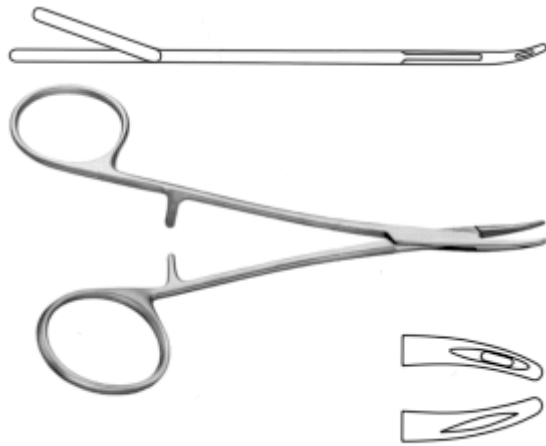

CONVERSE NEEDLE HOLDER

Item Code Description
TWS 84-3068/38 15 cm/ 6"

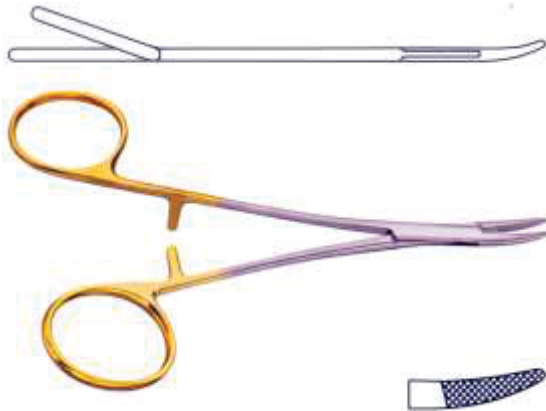

CONVERSE NEEDLE HOLDER

Item Code Description
TWS 84-3068/39 TC, 15 cm/ 6"

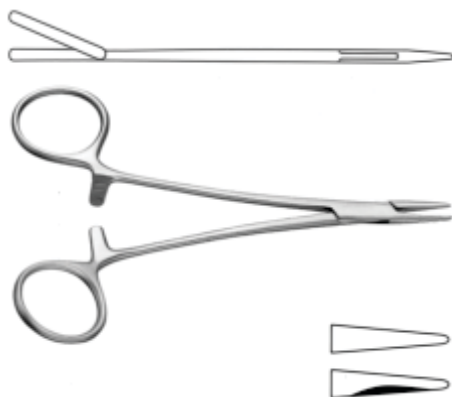

NEIVERT NEEDLE HOLDER

Item Code Description
TWS 84-3068/40 12 cm/ 5"



TW Surgical

NEEDLE HOLDERS



NEEDLE HOLDER, TC

Item Code	Description
TWS 84-3068/41	11.5 cm/ 4½"
TWS 84-3068/42	13 cm/ 5 1/8"



NEIVERT NEEDLE HOLDER

Item Code	Description
TWS 84-3068/43	TC, 12.5 cm/ 5"



WRIGHT (DERF) NEEDLE HOLDER

Item Code	Description
TWS 84-3068/44	12.5 cm/ 5"



NEEDLE HOLDER

Item Code	Description
TWS 84-3068/45	TC, 12.5 cm/ 5"

NEEDLE HOLDERS



TW Surgical



WRIGHT (DERF) NEEDLE HOLDER

Item Code	Description
<u>TWS 84-3068/46</u>	<u>TC, 12.5 cm/ 5"</u>



HALSEY NEEDLE HOLDER

Item Code	Description
<u>TWS 84-3068/47</u>	<u>13.5 cm/ 5 3/8"</u>



HALSEY NEEDLE HOLDER

Item Code	Description
<u>TWS 84-3068/48</u>	<u>TC, 13.5 cm/ 5 3/8"</u>

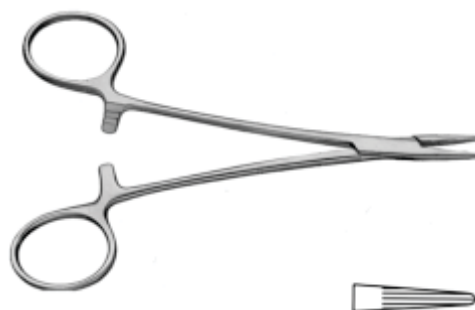

DERF CONVERSE NEEDLE HOLDER

Item Code	Description
<u>TWS 84-3068/49</u>	<u>12.5 cm/ 5"</u>



TW Surgical

NEEDLE HOLDERS



CRILE WOOD NEEDLE HOLDER

Item Code	Description
TWS 84-3068/50	15 cm/ 6"
TWS 84-3068/51	18 cm/ 7 1/8"
TWS 84-3068/52	20 cm/ 8"
TWS 84-3068/53	23 cm/ 9"



CRILE WOOD NEEDLE HOLDER, TC

Item Code	Description
TWS 84-3068/54	15 cm/ 6"
TWS 84-3068/55	18 cm/ 7 1/8"
TWS 84-3068/56	20 cm/ 8"
TWS 84-3068/57	23 cm/ 9"
TWS 84-3068/58	25 cm/ 10"
TWS 84-3068/59	30 cm/ 11 3/4"

NEEDLE HOLDERS

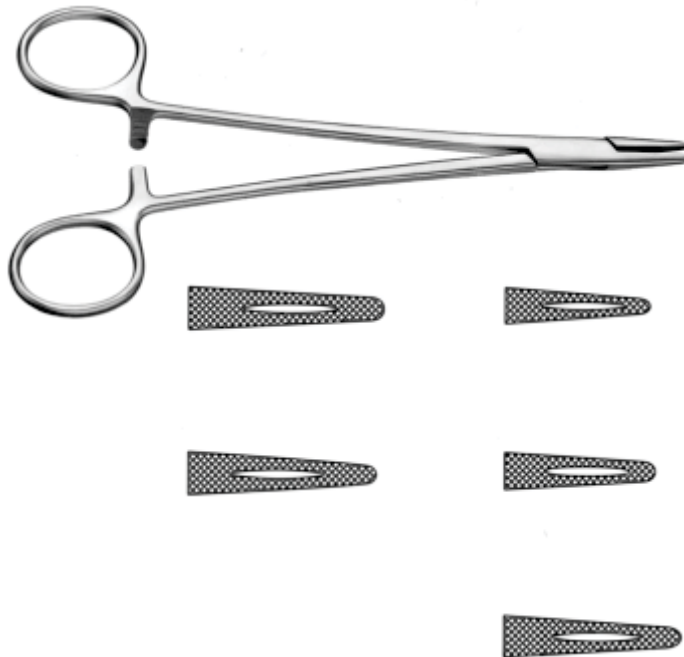

MAYO HEGAR NEEDLE HOLDER

Item Code	Description
TWS 84-3068/60	15 cm/ 6"
TWS 84-3068/61	18 cm/ 7 1/8"
TWS 84-3068/62	23 cm/ 9"
TWS 84-3068/63	24 cm/ 9 1/2"

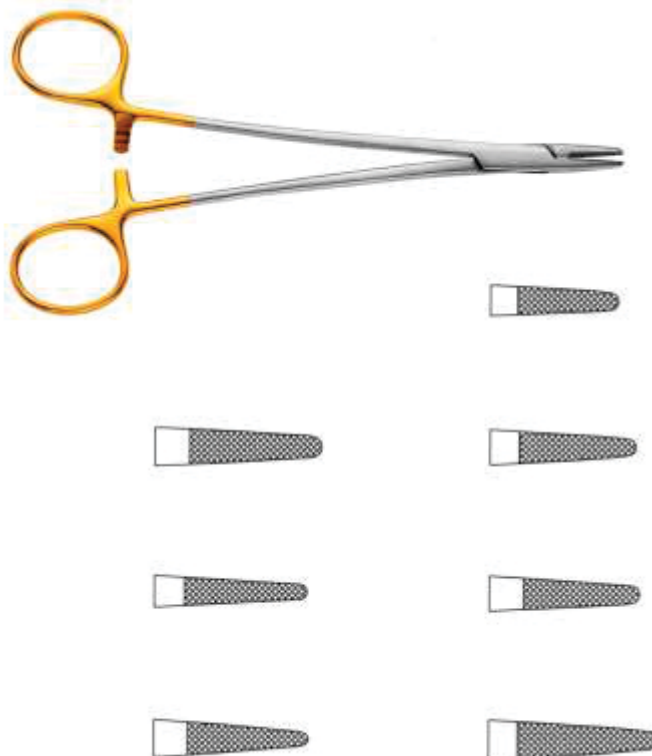

MAYO HEGAR NEEDLE HOLDER, TC

Item Code	Description
TWS 84-3068/64	15 cm/ 6"
TWS 84-3068/65	18 cm/ 7 1/8"
TWS 84-3068/66	23 cm/ 9"
TWS 84-3068/67	24 cm/ 9 1/2"
TWS 84-3068/68	26 cm/ 10 1/4"
TWS 84-3068/69	30 cm/ 11 3/4"



TW Surgical

NEEDLE HOLDERS

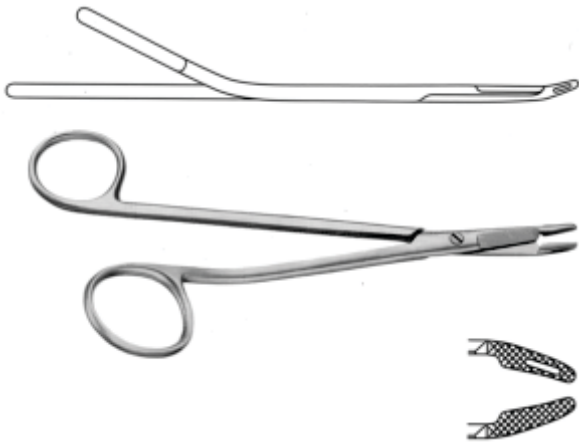

GILLIES SLIM NEEDLE HOLDER

Item Code	Description
TWS 84-3068/70	14.5 cm/ 5 ³ / ₄ "

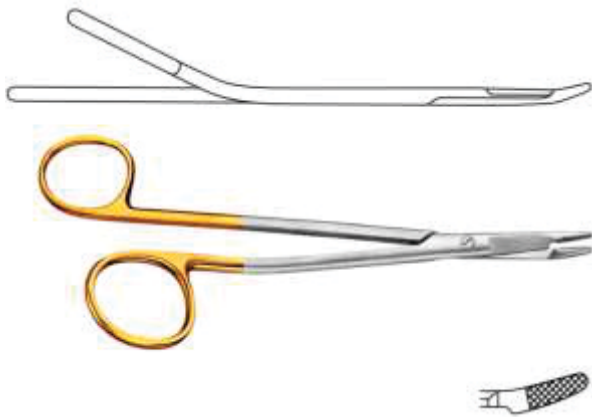

GILLIES SLIM NEEDLE HOLDER, TC

Item Code	Description
TWS 84-3068/71	14.5 cm/ 5 ³ / ₄ "



GILLIES NEEDLE HOLDER

Item Code	Description
TWS 84-3068/72	15.5 cm/ 6 1/8"



VESSEL DILATOR

Item Code	Description
TWS 84-3068/73	ANGLED, 11cm/ 4¼", 0.2mmØ



VESSEL DILATOR

Item Code	Description
TWS 84-3068/74	ANGLED, 11cm/ 4¼", 0.3mmØ

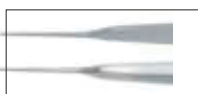

VESSEL DILATOR

Item Code	Description
TWS 84-3068/75	ANGLED, 13.5cm/ 5 3/8", 0.2mmØ



VESSEL DILATOR

Item Code	Description
TWS 84-3068/76	LONG ANGLED, 13.5cm/ 5 3/8", 0.2mmØ



VESSEL DILATOR

Item Code	Description
TWS 84-3068/77	LONG ANGLED, 18cm/ 7", .3mmØ



VESSEL DILATOR

Item Code	Description
TWS 84-3068/78	LONG ANGLED, 18cm/ 7", 0.2mmØ



TW Surgical

MICRO SURGERY INSTRUMENTS



ROUND BODIED VESSEL DILATOR

Item Code	Description
TWS 84-3068/79	15cm/ 6", 0.3mmØ, BALANCED FORCEPS



ROUND BODIED VESSEL DILATOR

Item Code	Description
TWS 84-3068/80	CURVED, 15cm/ 6", 0.2mmØ, BALANCED FORCEPS



ROUND BODIED VESSEL DILATOR

Item Code	Description
TWS 84-3068/81	18cm/ 7", 0.3mmØ, BALANCED FORCEPS



ROUND BODIED VESSEL DILATOR

Item Code	Description
TWS 84-3068/82	CURVED, 18cm/ 7", 0.3mmØ, BALANCED FORCEPS



JEWELLERS FORCEPS

Item Code	Description
TWS 84-3068/83	11cm/ 4¼", 0.3mmØ



JEWELLERS FORCEPS

Item Code	Description
TWS 84-3068/84	LONG, 15cm/ 6", 0.3mmØ



JEWELLERS FORCEPS

Item Code	Description
TWS 84-3068/85	12cm/ 4¾", 0.3mmØ



JEWELLERS FORCEPS

Item Code	Description
TWS 84-3068/86	13.5cm/ 5 3/8", 0.3mmØ



Pierse Forceps have a micro hole in the tips which securely grip tissue with minimal trauma



PIERSE FORCEPS

Item Code	Description
TWS 84-3068/87	12cm/ 4 3/4", 0.3mmØ



MICRO ADSON FIXATION FORCEPS

Item Code	Description
TWS 84-3068/88	12cm/ 4 3/4", 0.3mmØ, 1X2 MICRO TEETH



ROUND BODIED FORCEPS

Item Code	Description
TWS 84-3068/89	15cm/ 6", STRAIGHT, WITH PLATFORM, 0.3mmØ



ROUND BODIED FORCEPS

Item Code	Description
TWS 84-3068/90	15cm/ 6", CURVED, WITH PLATFORM, 0.3mmØ



ROUND BODIED FORCEPS

Item Code	Description
TWS 84-3068/91	15cm/ 6", ANGLED, 0.2mmØ



ROUND BODIED FORCEPS

Item Code	Description
TWS 84-3068/92	18cm/ 7", STRAIGHT, 0.5mmØ



TW
Surgical

Treasure Wright (U.K.) Ltd.

**Address: 128-160 , City Road,
London EC1V 2NX. United Kingdom**

www.twrightmedical.com

info@twrightmedical.com



TW Surgical



**UK
CA CE**