

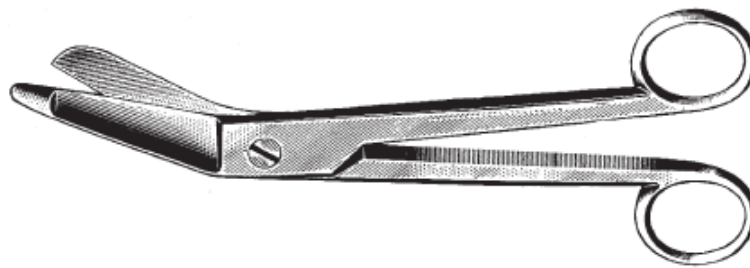

**TW**  
Surgical

# CASTROOM INSTRUMENT

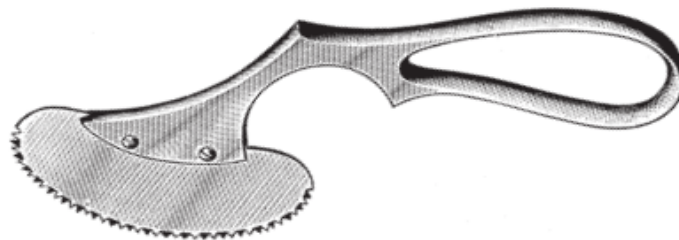

**UK  
CA CE**



TW Surgical

Treasure Wright (U.K.) Ltd.



[www.twrightmedical.com](http://www.twrightmedical.com)



[info@twrightmedical.com](mailto:info@twrightmedical.com)



TW Surgical

## BANDAGE SCISSORS

### SUPER-CUT BANDAGE

- Very little hand strength is required for cutting, putting less strain on thumb and forearm.
- Perfect cutting control because you don't have to force them to cut.
- Retain their sharpness longer than ordinary scissors.
- Not recommended for cutting plaster.

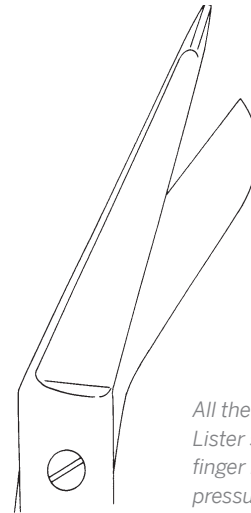
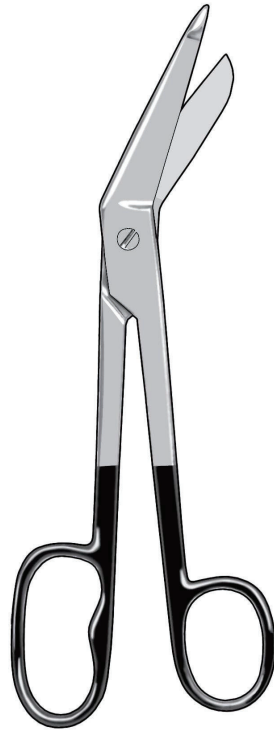

*All the benefits of our Super-Cut Lister scissors plus an oversized finger ring, which helps relieve pressure on the third metacarpal.*

TWS 84-2031/11  
8" (203mm)

### SUPER-CUT LISTER BANDAGE SCISSORS WITH LARGE FINGER RING



*Cuts bandages and multiple layers of dressings with ease. Razor-sharp blades reduce hand fatigue.*

TWS 84-2031/14  
5 1/2" (140mm)  
stainless

TWS 84-2031/15  
7 1/4" (184mm)  
stainless

### SUPER-CUT LISTER BANDAGE SCISSORS

**Treasure Wright (U.K.) Ltd.**

128-160 City Road, London, EC1V 2NX, United Kingdom  
info@twrightmedical.com



TW Surgical

# PLASTER CAST SCISSORS AND SHEARS



*For light plaster and cloth.*

TWS 84-2031/17 6" (152mm)  
Lister-type (not pictured)

TWS 84-2031/18 7 1/2" (191mm)  
one serrated blade  
with autoclavable plastic finger rings

**UTILITY SHEARS**

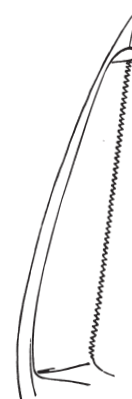

*For light weight plaster or aluminum casts.*

TWS 84-2031/19  
7 1/2" (191mm)  
one serrated blade

**HERCULES SCISSORS**



*Effective for cloth or cotton wadding.*

TWS 84-2031/20  
8" (203mm)  
one serrated blade  
with wire cutting notch

**UTILITY SHEARS**

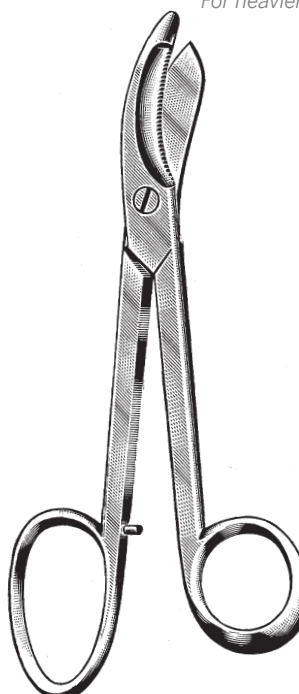

*For heavier plaster*

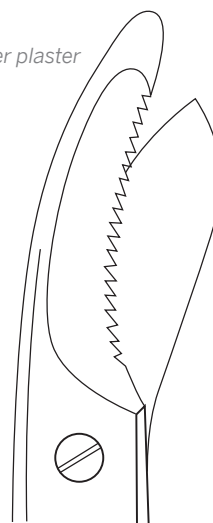

TWS 84-2031/21  
9 1/4" (235mm)  
one serrated blade

**BRUNS SHEARS**



TW Surgical

## PLASTER CAST INSTRUMENTS

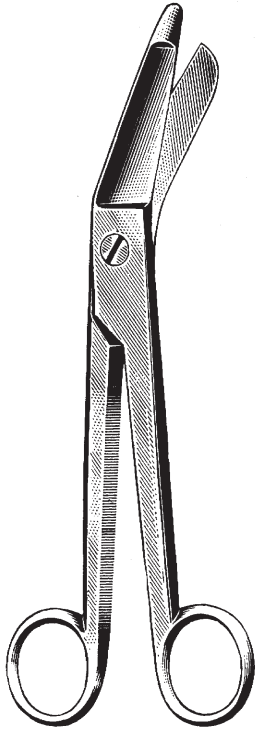

*Useful for cutting  
tape and bandages.*

TWS 84-2031/22  
8" (203mm)

**ESMARCH SHEARS**

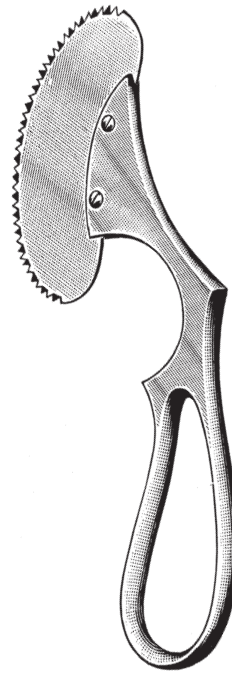

TWS 84-2031/23  
6" (152mm)  
with stainless blade  
chrome handle

**ENGEL PLASTER SAW**



TWS 84-2031/24  
7" (178mm)  
with stainless handle

**REINER PLASTER KNIFE**

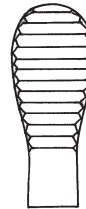

*For lightweight  
cast breaking  
and trimming.*

TWS 84-2031/25  
7" (178mm)  
deep serrated tips



**PEDIATRIC CAST BREAKER**

# PLASTER CAST INSTRUMENTS

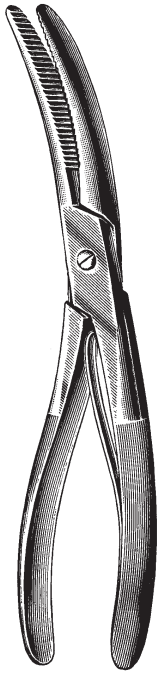

TWS 84-2031/26  
7" (178mm)  
small

TWS 84-2031/27  
9 1/2" (241mm)

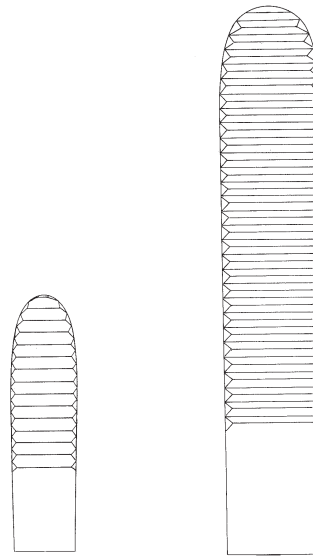

*For cast removal.*

**PLASTER BREAKER WOLFF (BOEHLER)**  
deep serrated tips

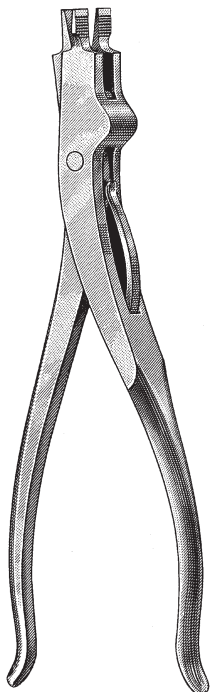

TWS 84-2031/30  
9" (229mm) serrated  
3 prongs

TWS 84-2031/31  
9" (229mm) serrated  
3 prongs

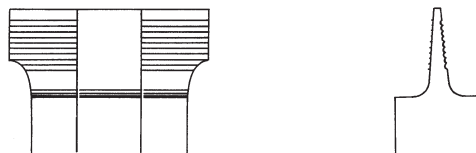

*To relieve cast pressure  
or for cast removal. One  
handed operation.*

**CAST  
SPREADER**

**WALTON CAST SPREADER**



TW Surgical

## PLASTER CAST INSTRUMENTS

*To relieve cast pressure  
or for cast removal.*

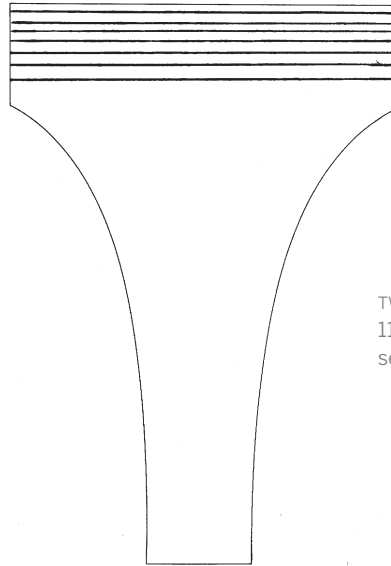
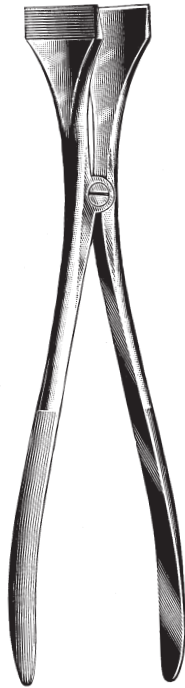

TWS 84-2031/32  
11" (279mm)  
serrated

### **HENNIG PLASTER SPREADER**

*For cast removal.*

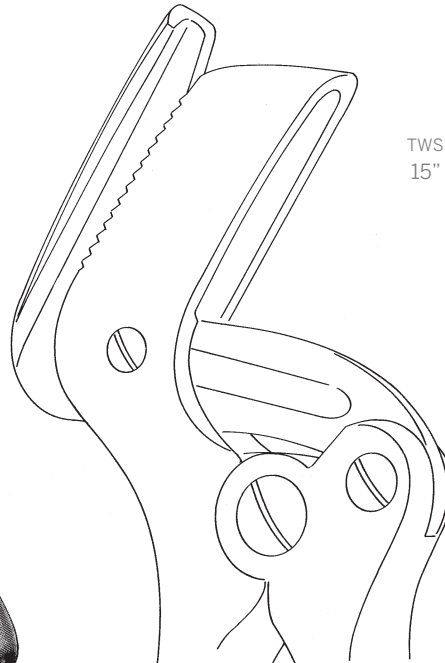

TWS 84-2031/33  
15" (381mm)

### **STILLE PLASTER SHEARS**

**Treasure Wright (U.K.) Ltd.**

128-160 City Road, London, EC1V 2NX, United Kingdom  
info@twrightmedical.com



**TW**  
Surgical

## Treasure Wright (U.K.) Ltd.

---

**Address: 128-160 , City Road,  
London EC1V 2NX. United Kingdom**

---

[www.twrightmedical.com](http://www.twrightmedical.com)

[info@twrightmedical.com](mailto:info@twrightmedical.com)



TW Surgical



**UK  
CA CE**