



**TW**  
Surgical

# BONE HOLDING



**UK  
CA CE**



TW Surgical

Treasure Wright (U.K.) Ltd.



[www.twrightmedical.com](http://www.twrightmedical.com)



[info@twrightmedical.com](mailto:info@twrightmedical.com)



TW Surgical

## BONE HOLDING INSTRUMENTS

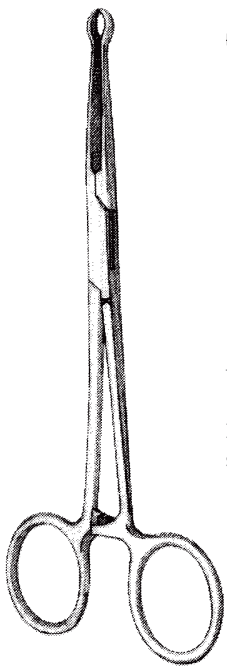

*Very useful for removing the sesamoid bone.*

TWS 84-2031/34  
6" (152mm)  
1x2 teeth  
serrated jaws

**LOCKE PHALANGEAL FORCEPS**

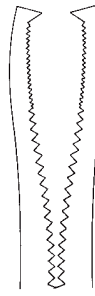
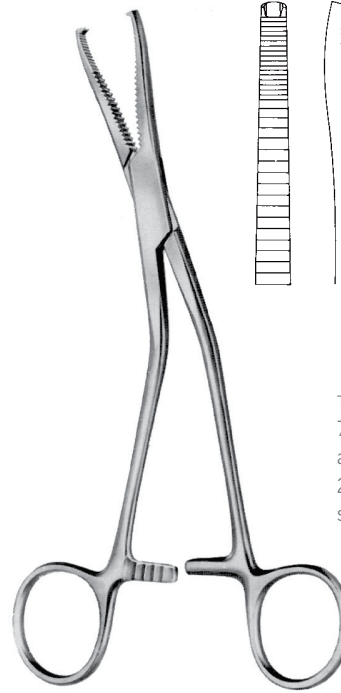

*Delicate serrated jaws for holding small bone fragments.*

TWS 84-2031/35  
7 1/2" (191mm)  
angular  
2x2 sharp teeth  
serrated jaws

**DINGMAN CARTILAGE AND BONE CLAMP**



TWS 84-2031/36  
6 1/2" (165mm)  
slightly curved

**SESAMOIDECTOMY CLAMP**



*For positioning mini bone plates.*

TWS 84-2031/37  
4 3/4" (121mm)  
one pointed tip  
and foot plate

**PLATE AND BONE HOLDING FORCEPS**



TW Surgical

# BONE HOLDING INSTRUMENTS

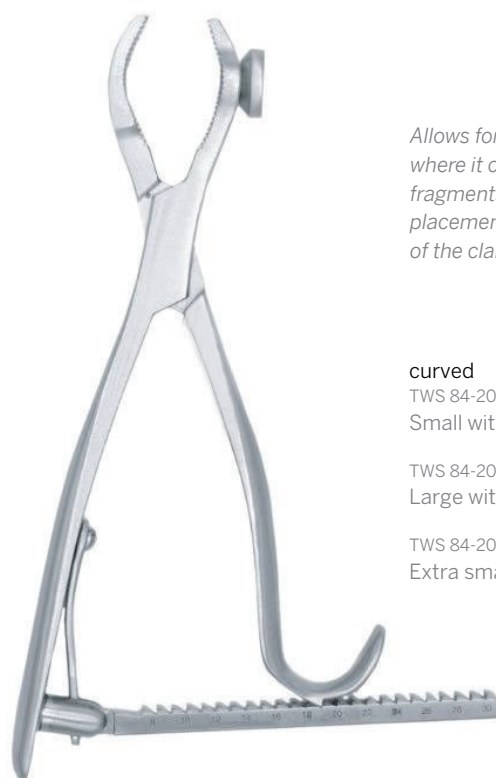

Allows for placement of the bone clamp where it can best stabilize the bone fragments. The drill guide allows for screw placement through the opening at the top of the clamp.

- curved**
- TWS 84-2031/38  
Small with 8mm drill guide with ratchet
- TWS 84-2031/39  
Large with 10mm drill guide with ratchet
- TWS 84-2031/40  
Extra small with 6mm drill guide with ratchet

**O'BRIEN BONE CLAMP**

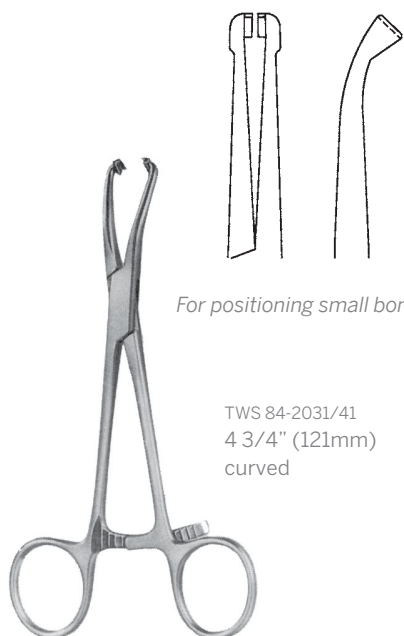

For positioning small bone plates.

TWS 84-2031/41  
4 3/4" (121mm)  
curved

**PLATE AND BONE HOLDING FORCEPS**

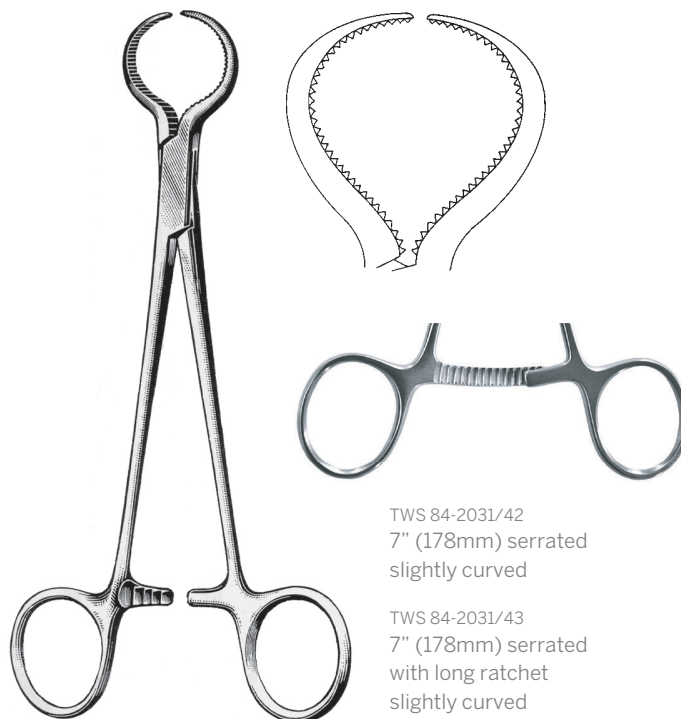

TWS 84-2031/42  
7" (178mm) serrated  
slightly curved

TWS 84-2031/43  
7" (178mm) serrated  
with long ratchet  
slightly curved

**LEWIN BONE FORCEPS**



TW Surgical

## BONE HOLDING INSTRUMENTS



TWS 84-2031/44  
7" (178mm)  
with speed lock  
2x2 sharp teeth

**PATELLA FORCEPS**

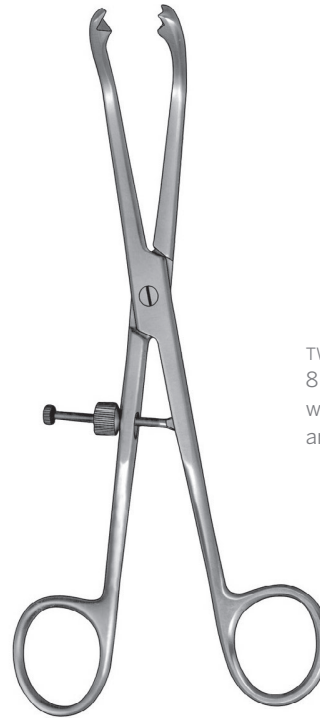

TWS 84-2031/45  
8 1/2" (216mm)  
with speed lock  
angular tip

**FIBULA FORCEPS**



*Grasping forceps  
for small bones.*

TWS 84-2031/46  
8 1/4" (210mm)  
1x1 sharp points

**MALLEOLLAR FORCEPS**

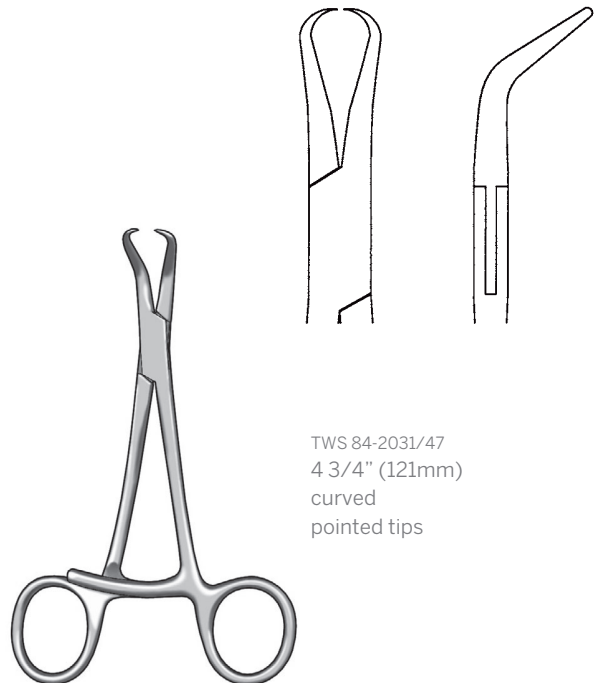

TWS 84-2031/47  
4 3/4" (121mm)  
curved  
pointed tips

**STAGBEETLE BONE  
REDUCTION FORCEPS**

Treasure Wright (U.K.) Ltd.

128-160 City Road, London, EC1V 2NX, United Kingdom  
info@twrightmedical.com



TW Surgical

# BONE HOLDING INSTRUMENTS

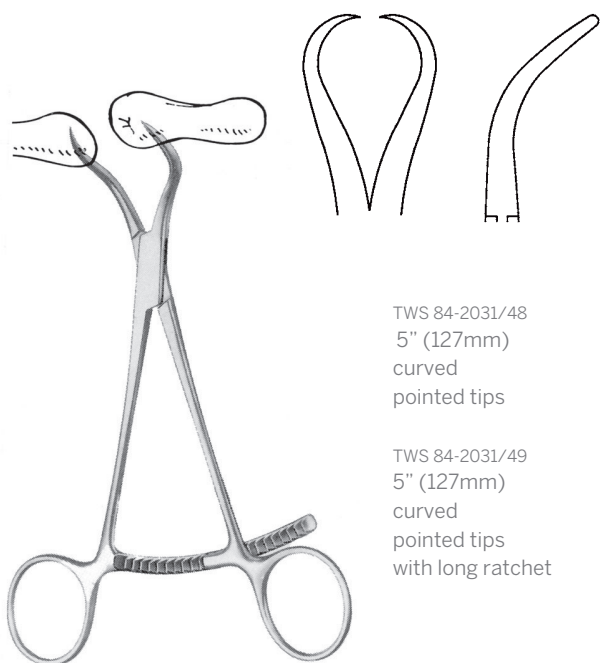

TWS 84-2031/48  
5" (127mm)  
curved  
pointed tips

TWS 84-2031/49  
5" (127mm)  
curved  
pointed tips  
with long ratchet

## BONE REDUCTION FORCEPS

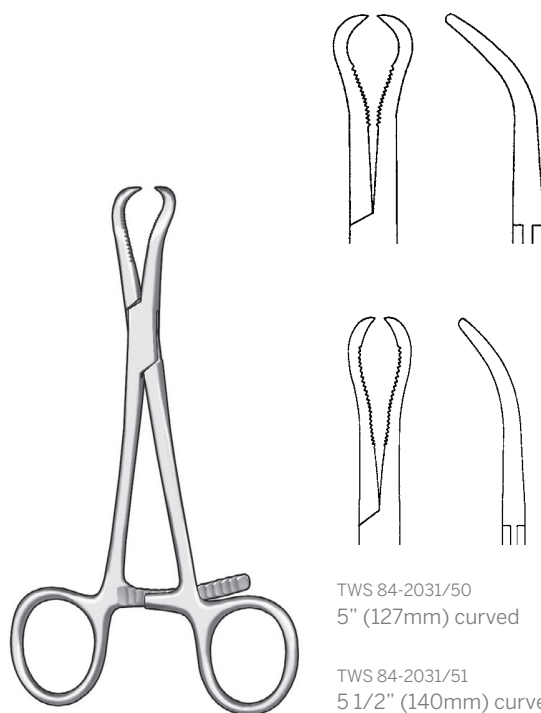

TWS 84-2031/50  
5" (127mm) curved

TWS 84-2031/51  
5 1/2" (140mm) curved

## BONE REDUCTION FORCEPS

Serrated with pointed tips

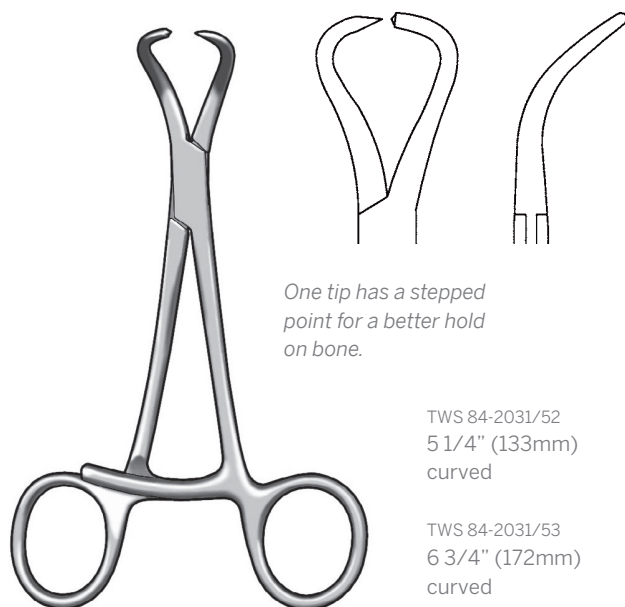

*One tip has a stepped point for a better hold on bone.*

TWS 84-2031/52  
5 1/4" (133mm)  
curved

TWS 84-2031/53  
6 3/4" (172mm)  
curved

## BONE REDUCTION FORCEPS

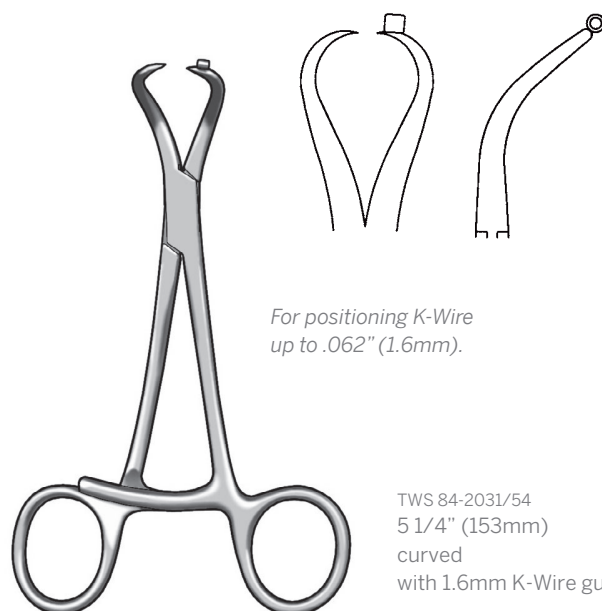

*For positioning K-Wire up to .062" (1.6mm).*

TWS 84-2031/54  
5 1/4" (153mm)  
curved  
with 1.6mm K-Wire guide

## BONE HOLDING FORCEPS



TW Surgical

## BONE HOLDING INSTRUMENTS

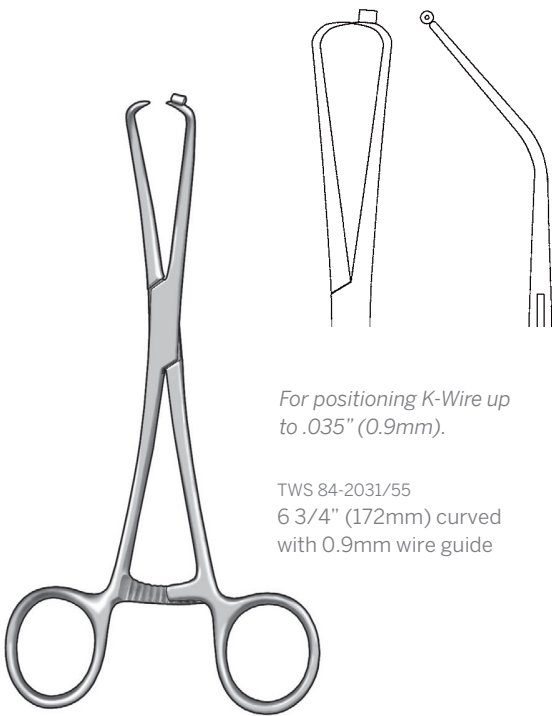

*For positioning K-Wire up to .035" (0.9mm).*

TWS 84-2031/55  
6 3/4" (172mm) curved  
with 0.9mm wire guide

### BONE HOLDING FORCEPS

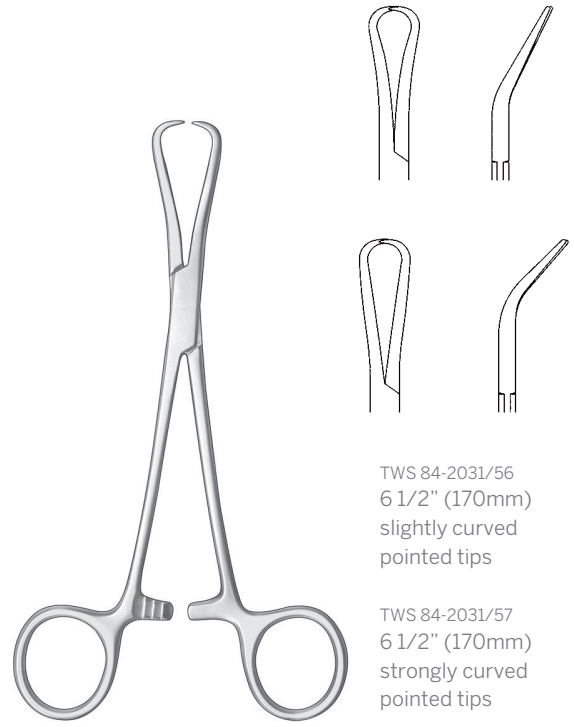

TWS 84-2031/56  
6 1/2" (170mm)  
slightly curved  
pointed tips

TWS 84-2031/57  
6 1/2" (170mm)  
strongly curved  
pointed tips

### GLENOID PERFORATING FORCEPS

TWS 84-2031/58  
6" (152mm)  
angular  
inside fenestration: 22mm x 14mm  
outside fenestration: 30mm x 20mm  
ratchet length: 3"



### BONE HOLDING FORCEPS with fenestration

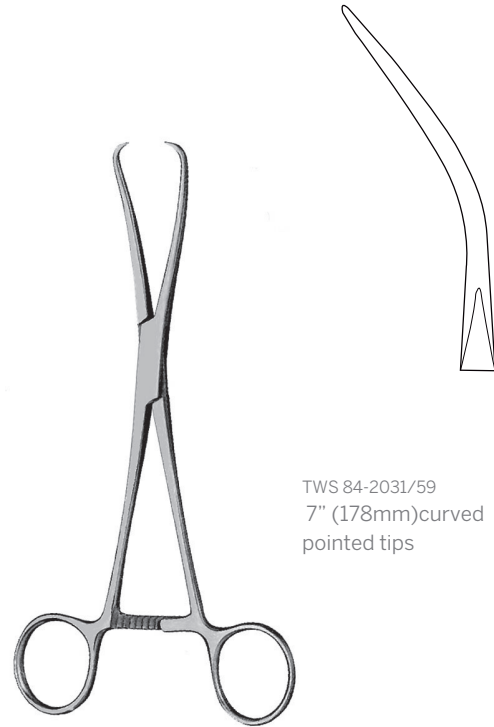

TWS 84-2031/59  
7" (178mm) curved  
pointed tips

### REILL BONE REDUCTION FORCEPS

Treasure Wright (U.K.) Ltd.

128-160 City Road, London, EC1V 2NX, United Kingdom  
info@twrightmedical.com



TW Surgical

# BONE HOLDING INSTRUMENTS



## BONE REDUCTION FORCEPS

TWS 84-2131/60 5 1/2" (140mm) curved narrow tip

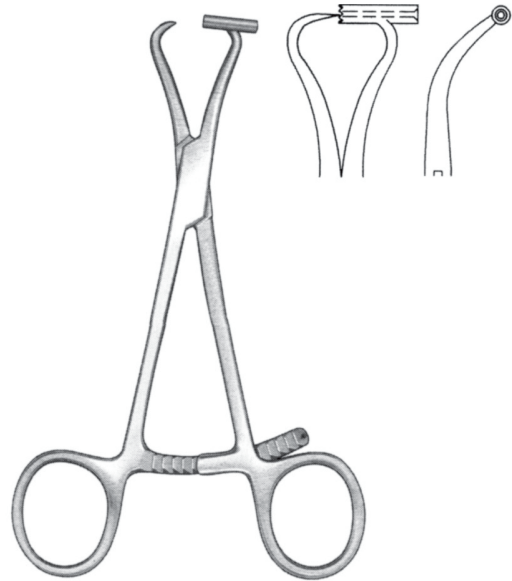

TWS 84-2031/60 5" (127mm) .035" (0.9mm) curved  
TWS 84-2031/61 5" (127mm) .045" (1.1mm) curved  
TWS 84-2031/62 5" (127mm) .062" (1.6mm) curved

## BONE HOLDING FORCEPS

With K-Wire guide

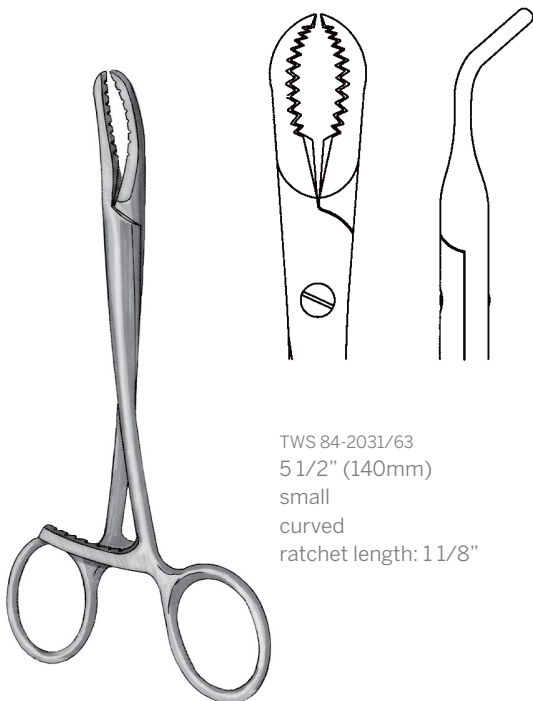

TWS 84-2031/63  
5 1/2" (140mm)  
small  
curved  
ratchet length: 1 1/8"

## BONE REDUCTION FORCEPS

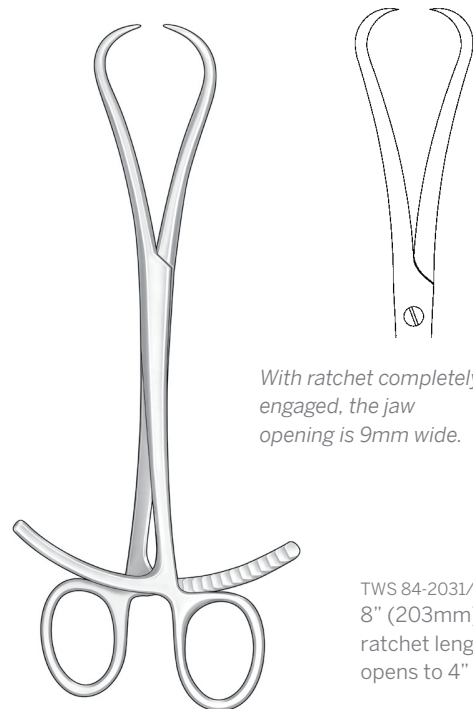

With ratchet completely engaged, the jaw opening is 9mm wide.

TWS 84-2031/64  
8" (203mm)  
ratchet length: 2"  
opens to 4"

## BONE REDUCTION FORCEPS



TW Surgical

## BONE HOLDING INSTRUMENTS



TWS 84-2031/65  
10 1/4" (260mm)

### REPOSITION FORCEPS



TWS 84-2031/66  
Small, 5 1/2" (140mm) with speed lock

TWS 84-2031/67  
Medium, 6" (152mm) with speed lock

TWS 84-2031/68  
Large, 8" (203mm) with speed lock

### BONE FRAGMENT CLAMP



TWS 84-2031/69  
5 1/2" (140mm) curved  
serrated with pointed tips extra  
long ratchet

### BONE REDUCTION FORCEPS

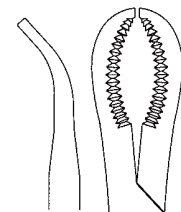

TWS 84-2031/70 7" (178mm) curved  
TWS 84-2031/71 9" (229mm) curved

### BONE REDUCTION FORCEPS

With speed lock

Treasure Wright (U.K.) Ltd.

128-160 City Road, London, EC1V 2NX, United Kingdom  
info@twrightmedical.com



TW Surgical

# BONE HOLDING INSTRUMENTS



TWS 84-2031/72  
7 1/2" (191mm)  
curved sideways  
deep teeth  
without ratchet



TWS 84-2031/73  
8" (203mm)  
curved sideways  
deep teeth  
with ratchet

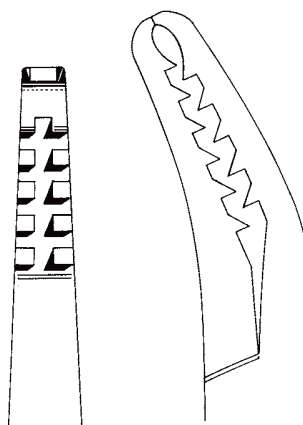

## SEMB BONE HOLDING FORCEPS

With or without ratchet



TWS 84-2031/74  
9" (229mm)  
curved sideways  
serrated



## VAN BUREN SEQUESTNUM FORCEPS



TWS 84-2031/75  
8 1/4" (210mm)  
deep teeth

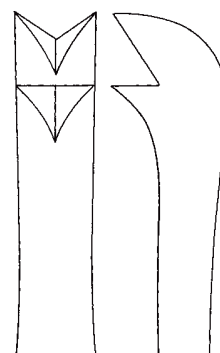

## FERGUSSON BONE HOLDING FORCEPS



TW Surgical

## BONE HOLDING INSTRUMENTS



TWS 84-2031/76  
8 1/4" (210mm)  
2x2 teeth

**LANGENBECK BONE HOLDING FORCEPS**

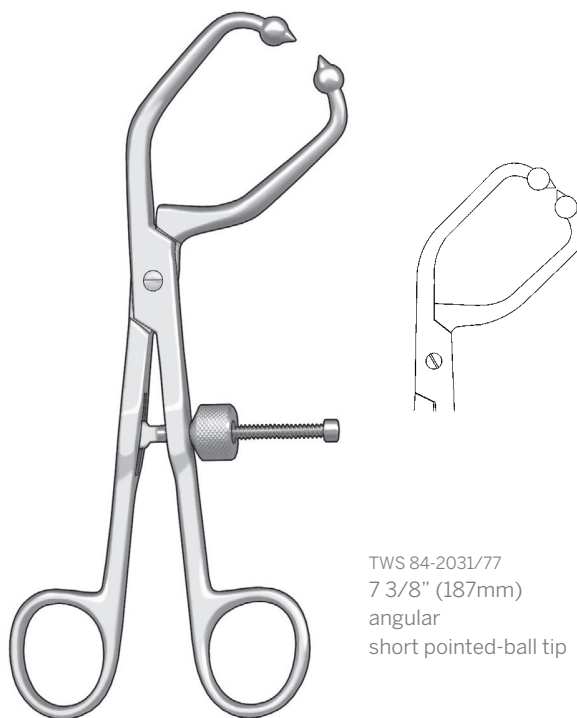

TWS 84-2031/77  
7 3/8" (187mm)  
angular  
short pointed-ball tip

**PELVIC REDUCTION FORCEPS**

Short tips

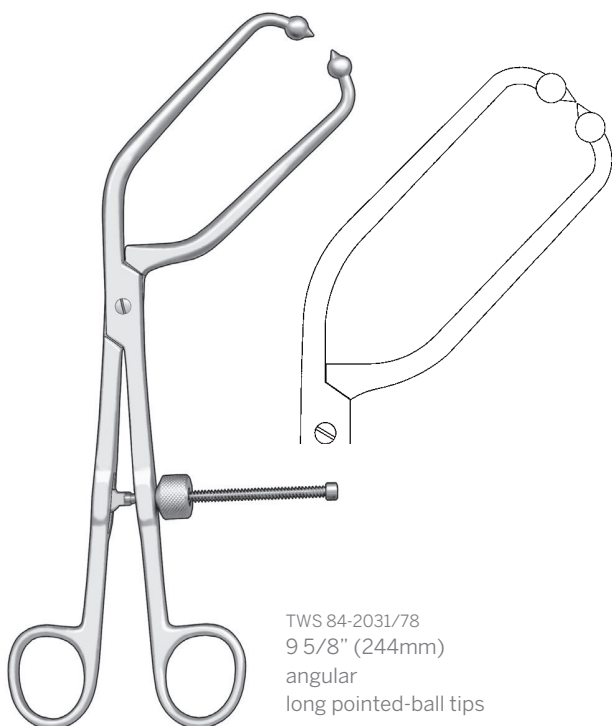

TWS 84-2031/78  
9 5/8" (244mm)  
angular  
long pointed-ball tips

**PELVIC REDUCTION FORCEPS**

Long tips

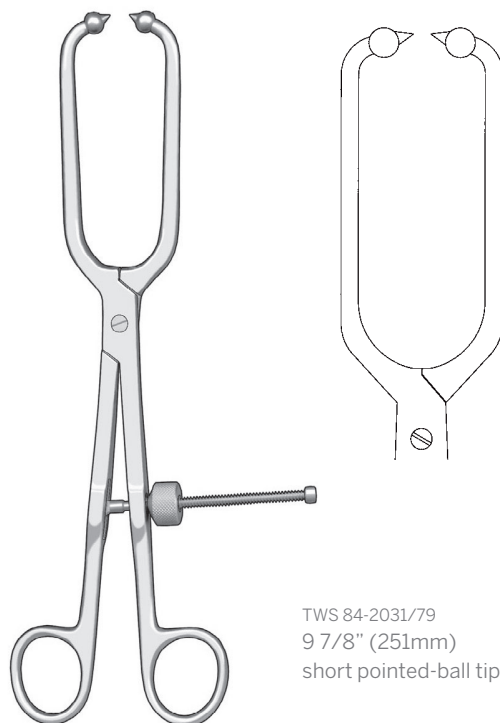

TWS 84-2031/79  
9 7/8" (251mm)  
short pointed-ball tips

**PELVIC REDUCTION FORCEPS**

Angled tips



TW Surgical

# BONE HOLDING INSTRUMENTS

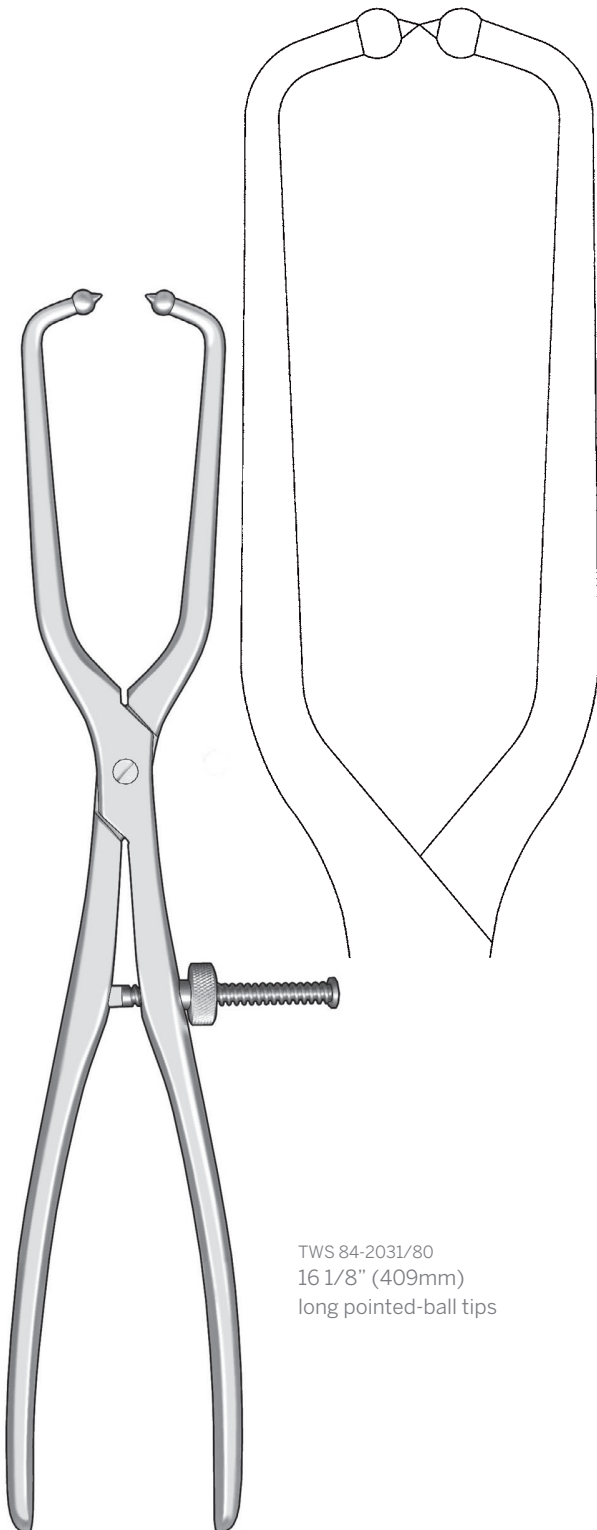

TWS 84-2031/80  
16 1/8" (409mm)  
long pointed-ball tips

**PELVIC REDUCTION FORCEPS**

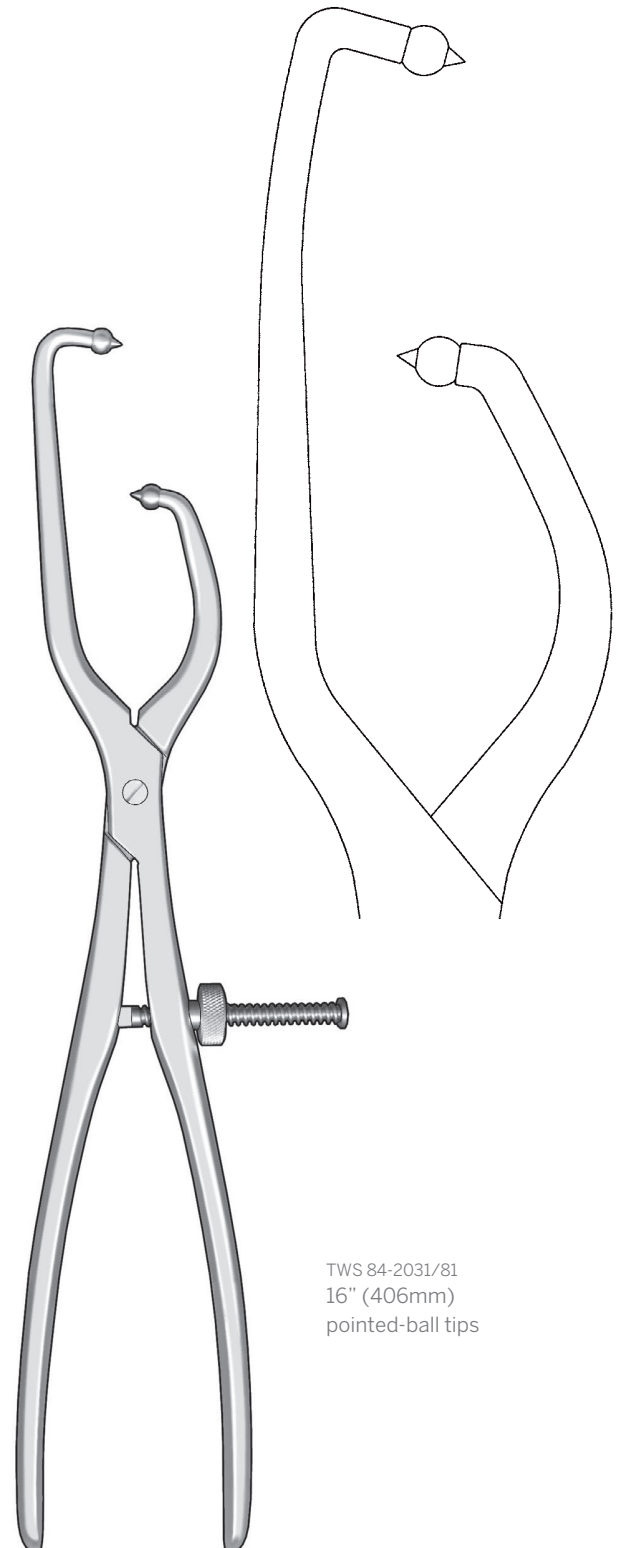

TWS 84-2031/81  
16" (406mm)  
pointed-ball tips

**ASYMMETRIC PELVIC REDUCTION FORCEPS**



TW Surgical

## BONE HOLDING INSTRUMENTS

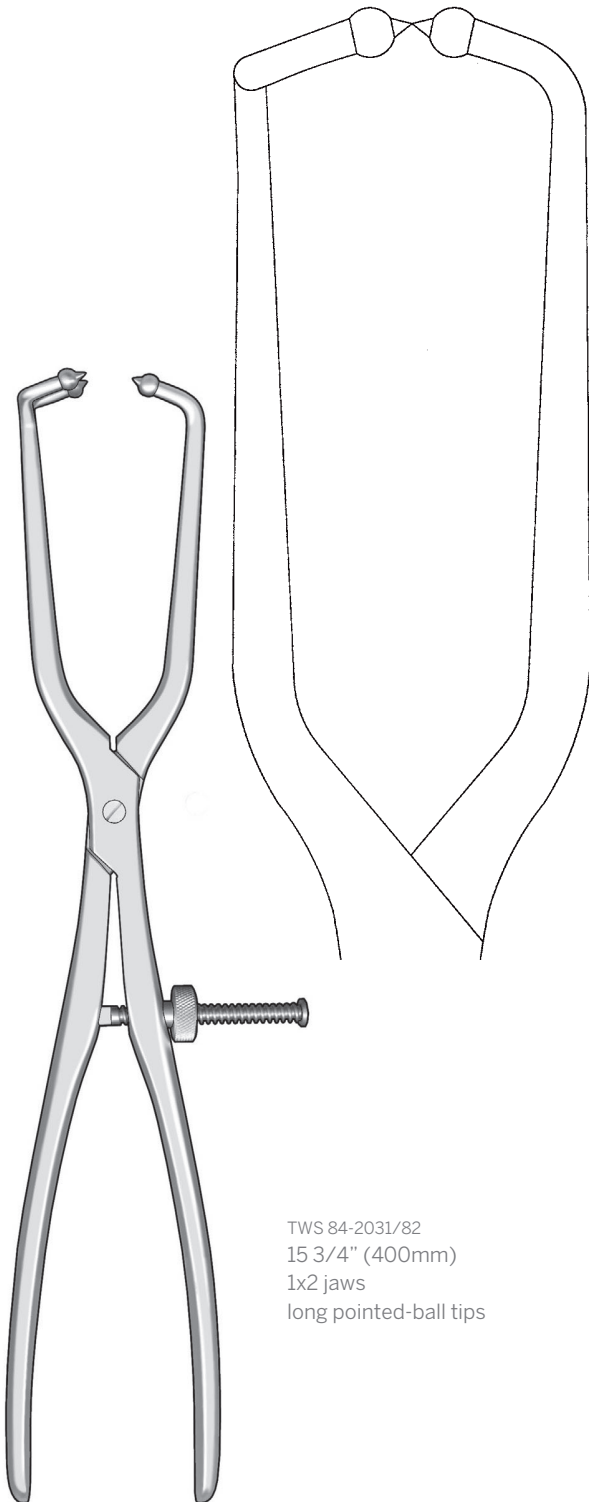

TWS 84-2031/82  
15 3/4" (400mm)  
1x2 jaws  
long pointed-ball tips

**PELVIC REDUCTION FORCEPS**

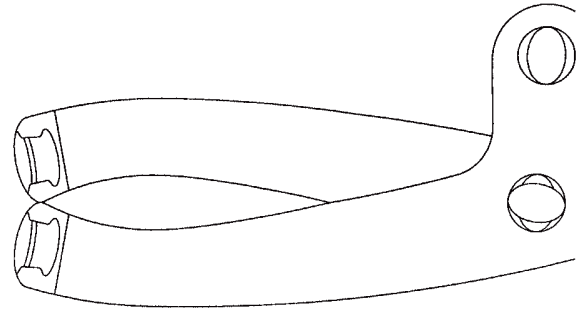

TWS 84-2031/83  
13 1/2" (343mm)  
with screws

**PELVIC REDUCTION FORCEPS**



TW Surgical

# BONE HOLDING INSTRUMENTS

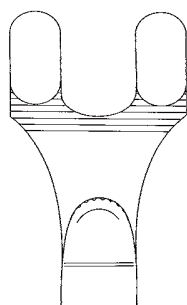

TWS 84-2031/84  
4 3/4" (121mm)

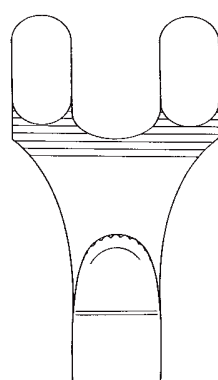

TWS 84-2031/85  
7 1/4" (184mm)

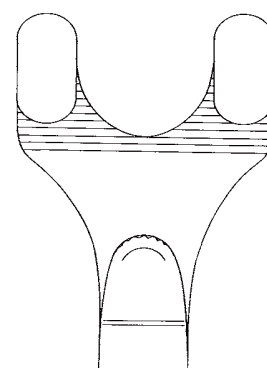

TWS 84-2031/86  
8" (203mm)

Calibrated in inches to  
measure bone diameter.

## LOWMAN BONE CLAMP

1x2 jaws

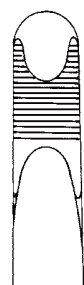
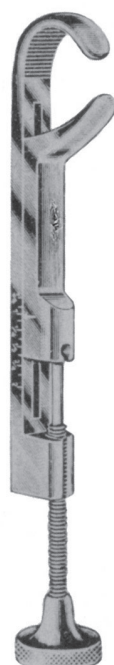

TWS 84-2031/87  
4 3/4" (121mm)

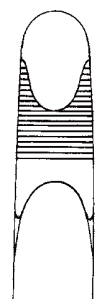

TWS 84-2031/88  
7 1/4" (184mm)

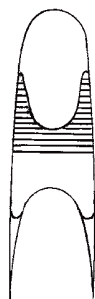

TWS 84-2031/89  
8" (203mm)

Calibrated in inches to  
measure bone diameter.

## LOWMAN BONE CLAMP

1x1 jaws

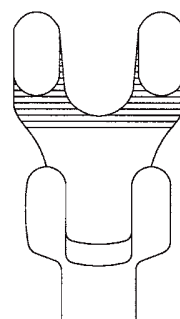
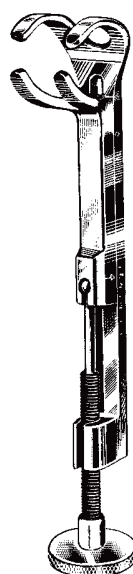

TWS 84-2031/90  
7 1/4" (184mm)

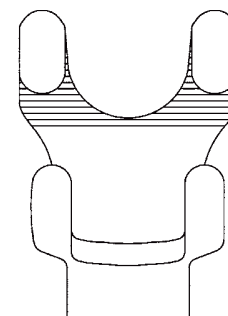

TWS 84-2031/91  
8" (203mm)

Calibrated in inches to  
measure bone diameter.

## LAMBERT-LOWMAN BONE CLAMP

2x2 jaws

Treasure Wright (U.K.) Ltd.

128-160 City Road, London, EC1V 2NX, United Kingdom  
info@twrightmedical.com



TW Surgical

## BONE HOLDING INSTRUMENTS

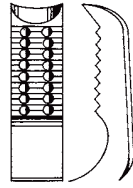

TWS 84-2031/92  
5 3/4" (146mm)  
mini

TWS 84-2031/93  
8 1/2" (216mm)

### KERN BONE FORCEPS

Without ratchet

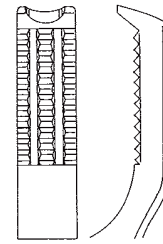

TWS 84-2031/94  
5 3/4" (146mm)  
mini

TWS 84-2031/95  
8 1/2" (216mm)

### KERN BONE FORCEPS

With ratchet

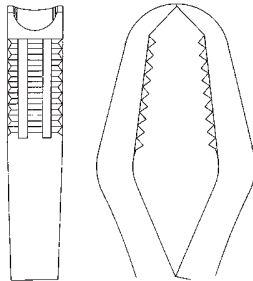

TWS 84-2031/96  
13" (330mm)  
light model  
without ratchet

TWS 84-2031/97  
13" (330mm)  
light model  
with ratchet

### LANE BONE HOLDING FORCEPS

Without ratchet

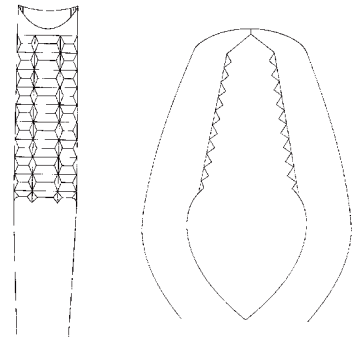

*Particularly well suited  
for use during insertion of  
intermedullary nails.*

TWS 84-2031/98  
13" (330mm)  
standard model  
without ratchet

TWS 84-2031/99  
13" (330mm)  
standard model  
with ratchet

### LANE BONE HOLDING FORCEPS

With ratchet

Treasure Wright (U.K.) Ltd.

128-160 City Road, London, EC1V 2NX, United Kingdom  
info@twrightmedical.com



TW Surgical

# BONE HOLDING INSTRUMENTS

TWS 84-2032/00  
17" (432mm)  
without ratchet



**LANE BONE FORCEPS**  
Without ratchet

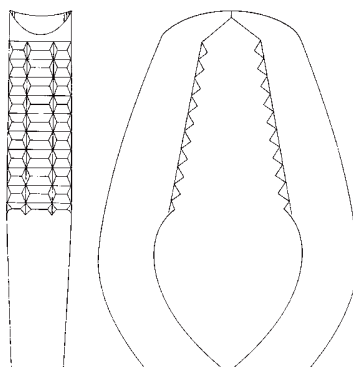

TWS 84-2032/01  
17" (432mm)with  
ratchet

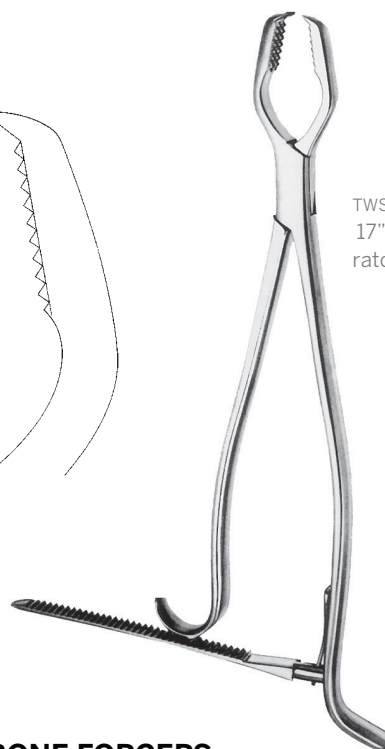

**LANE BONE FORCEPS**  
With ratchet



*Fit thin end of band through slot  
in other end of band. Insert thin  
end into clamp.*

TWS 84-2032/02  
8 1/2" (216mm)  
bands not included

TWS 84-2032/03  
single band only

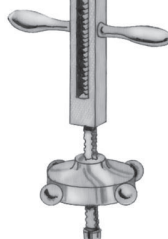

**PARHAM-MARTIN BONE CLAMP**

## BONE HOLDING INSTRUMENTS

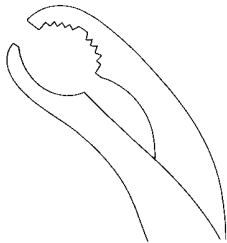

TWS 84-2032/04

6" (152mm)

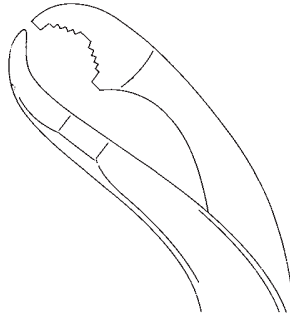

TWS 84-2032/05

7 1/2" (191mm)

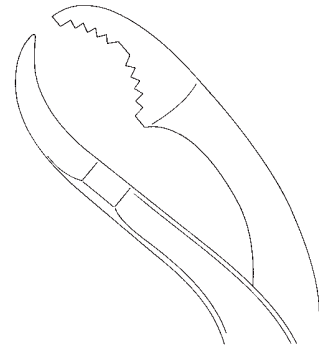

TWS 84-2032/06

9 1/2" (241mm)

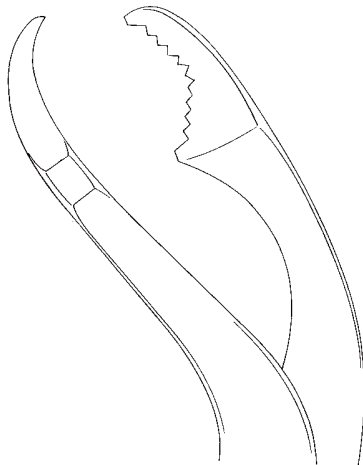

TWS 84-2032/07  
10 1/4" (260mm)

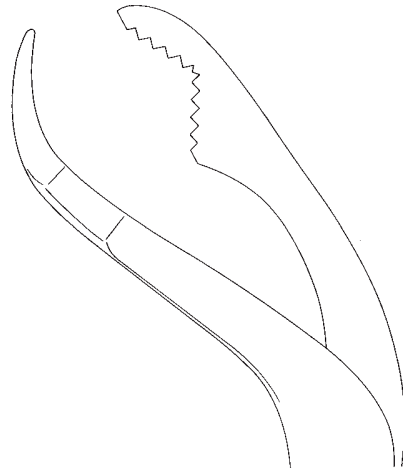

TWS 84-2032/08  
11" (280mm)

### VERBRUGGE BONE HOLDING FORCEPS

Self centering, with speed lock



TW Surgical

## BONE HOLDING INSTRUMENTS

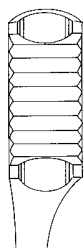
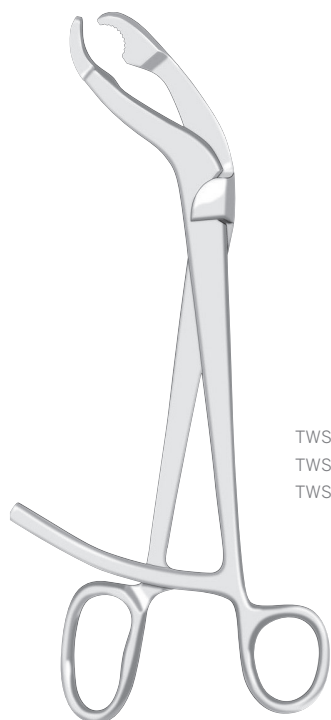

TWS 84-2032/09 10" (254mm)  
TWS 84-2032/10 10 1/2" (267mm)  
TWS 84-2032/11 11" (280mm)

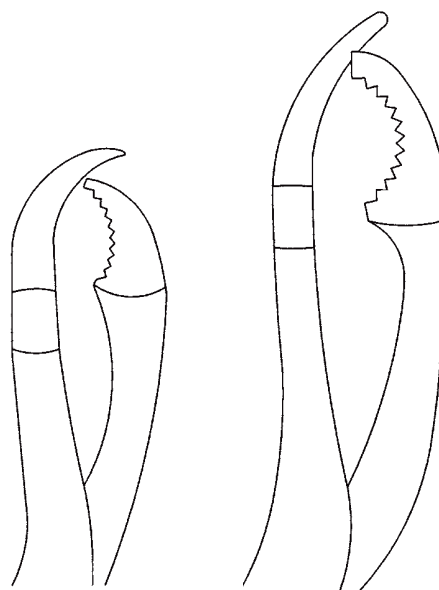

### VERBRUGGE BONE HOLDING FORCEPS

With long ratchet

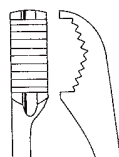
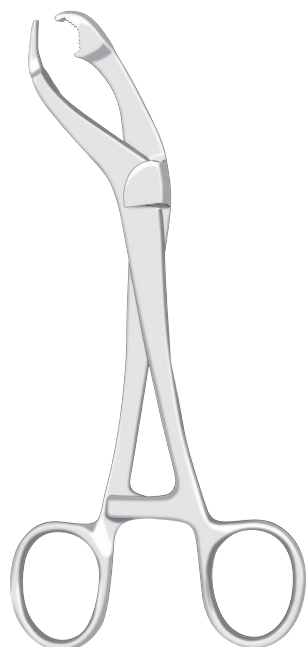

TWS 84-2032/14  
6 3/4" (172mm)

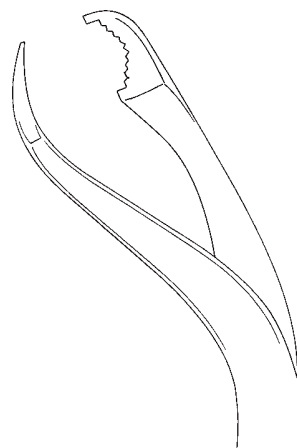

### VERBRUGGE BONE HOLDING FORCEPS

With short ratchet

Treasure Wright (U.K.) Ltd.

128-160 City Road, London, EC1V 2NX, United Kingdom  
info@twrightmedical.com



TW Surgical

## BONE HOLDING INSTRUMENTS

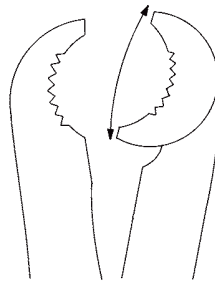

TWS 84-2032/16 8 1/2" (216mm)  
TWS 84-2032/17 10 1/2" (267mm)  
TWS 84-2032/18 11 1/2" (292mm)



### LAMBOTTE BONE HOLDING FORCEPS

With swivel head, adjustable jaw

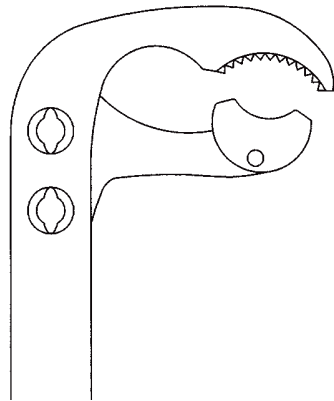

TWS 84-2032/19  
8 1/2" (216mm)  
with swivel head, adjustable jaw



### BONE HOLDING FORCEPS

Angled

Treasure Wright (U.K.) Ltd.

128-160 City Road, London, EC1V 2NX, United Kingdom  
info@twrightmedical.com



TW Surgical

# BONE HOLDING INSTRUMENTS

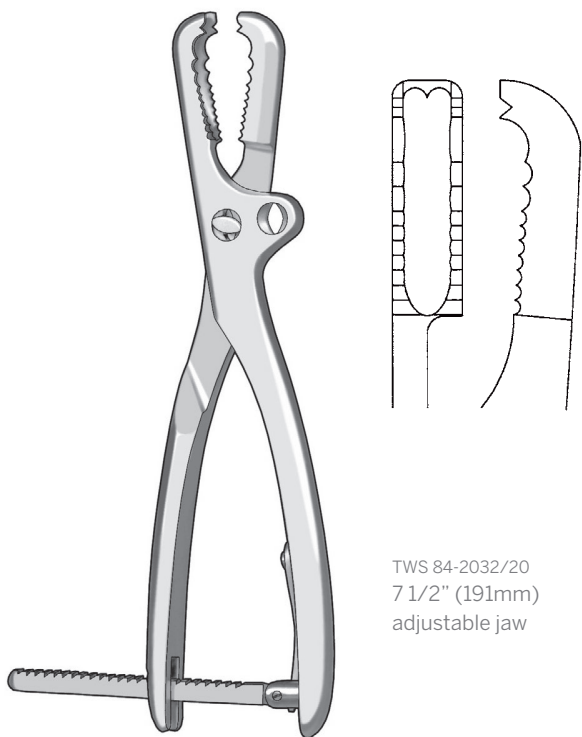

TWS 84-2032/20  
7 1/2" (191mm)  
adjustable jaw

**FARABEU-F-LAMBOTTE BONE HOLDING FORCEPS**



TWS 84-2032/21  
10 1/2" (267mm)  
adjustable jaw

**FARABEU-F-LAMBOTTE BONE HOLDING FORCEPS**



TWS 84-2032/22 9" (229mm)  
TWS 84-2032/23 10" (254mm)

**FARABEU BONE HOLDING FORCEPS**  
Adjustable jaw

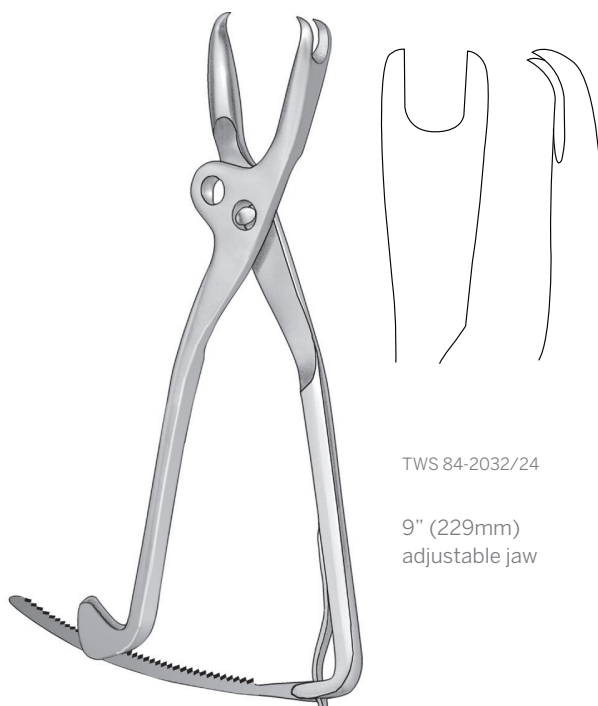

TWS 84-2032/24  
9" (229mm)  
adjustable jaw

**BISHOP BONE HOLDING FORCEPS**



TW Surgical

## BONE HOLDING INSTRUMENTS

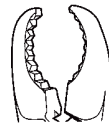

TWS 84-2032/25  
7 1/4" (184mm)  
mini

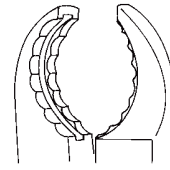

TWS 84-2032/26  
9" (229mm)

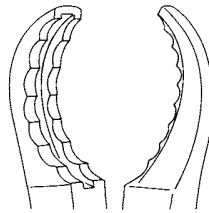

TWS 84-2032/27  
10" (254mm)

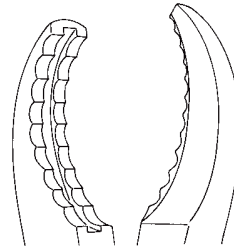

TWS 84-2032/28  
11" (280mm)

### ULRICH SELF-RETAINING FORCEPS

Straight, with speed lock

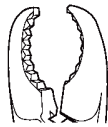

TWS 84-2032/29  
7 1/4" (184mm)

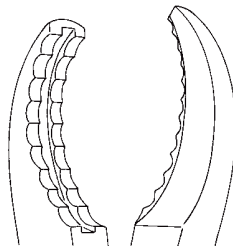

TWS 84-2032/30  
11" (280mm)

### ULRICH SELF-RETAINING FORCEPS

Angular, with speed lock

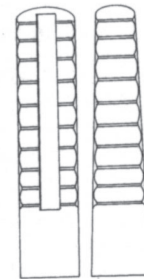

TWS 84-2032/31  
11" (280mm)  
angular  
with speed lock  
swivel jaw

### ULRICH SELF-RETAINING FORCEPS

Treasure Wright (U.K.) Ltd.

128-160 City Road, London, EC1V 2NX, United Kingdom  
info@twrightmedical.com



TW Surgical

# BONE HOLDING INSTRUMENTS



TWS 84-2032/32  
12" (305mm)  
X-large opening 30-100mm



TWS 84-2032/33 Medium 15" w/speedlock opening 14mm to 190mm  
TWS 84-2032/34 Large 15" w/speedlock opening 32mm to 210mm

## PERIARTICULAR REDUCTION CLAMP

## PERIARTICULAR REDUCTION CLAMP

Treasure Wright (U.K.) Ltd.

128-160 City Road, London, EC1V 2NX, United Kingdom  
info@twrightmedical.com



TW Surgical

## BONE HOLDING INSTRUMENTS



TWS 84-2032/35	5 1/4"	(133mm)	small
TWS 84-2032/36	6 1/2"	(165mm)	medium
TWS 84-2032/37	9"	(229mm)	large



**PERIARTICULAR  
REDUCTION CLAMP**

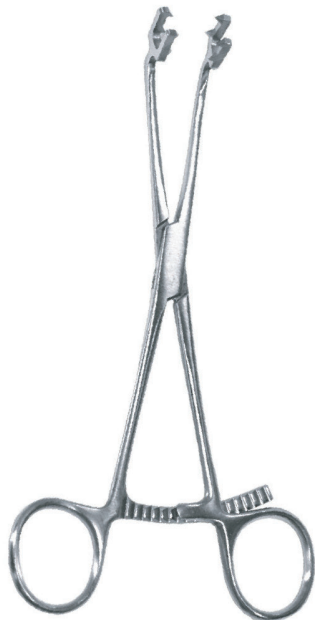

TWS 84-2032/41	6 1/4"	(159mm)	straight
TWS 84-2032/42	6 1/4"	(159mm)	curved

**IKUTA BONE CLAMP**



TWS 84-2032/40  
5 3/4" CVD (146mm)

**BONE REDUCTION FORCEPS**



TW Surgical

# BONE HOLDING INSTRUMENTS

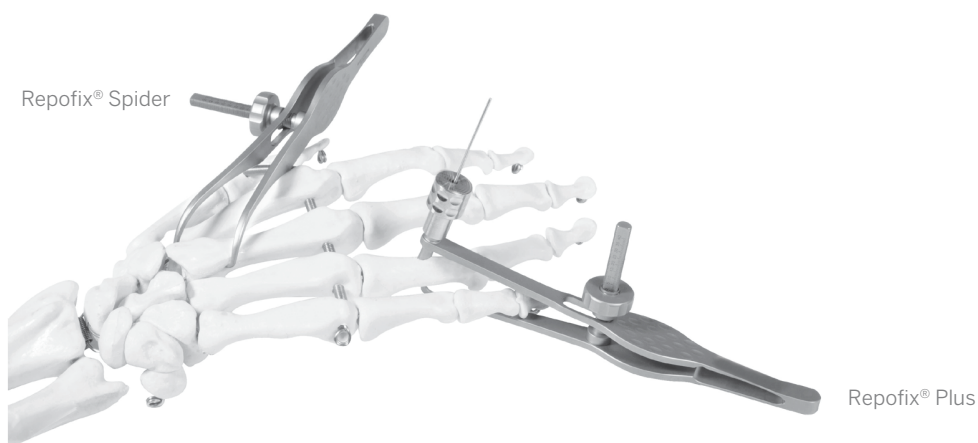

Drill



Measure



Insert screw

- Forcep (only)
- TWS 84-2032/43
- 5" (127mm)
- 3.5mm Inner diameter of tube, for guides and implants (screws/wires)
- 40mm Maximum measurable bone width

### Available Drill/Wire Guides

- .8mm drill/wire opening TWS 84-2032/44
- .9mm drill/wire opening TWS 84-2032/45
- 1.0mm drill/wire opening TWS 84-2032/46
- 1.1mm drill/wire opening TWS 84-2032/47
- 1.2mm drill/wire opening TWS 84-2032/48
- 1.3mm drill/wire opening TWS 84-2032/49

### Sterilization Tray

TWS 84-2032/50

Large enough to contain Repofix® Plus and Repofix® Spider

Repofix complete set with all guides and sterilization tray

TWS 84-2032/52-Set



## REPOFIX® PLUS

Maintains reduction as you drill, measure, & insert screws or wires through forcep tube.

Treasure Wright (U.K.) Ltd.

128-160 City Road, London, EC1V 2NX, United Kingdom  
info@twrightmedical.com

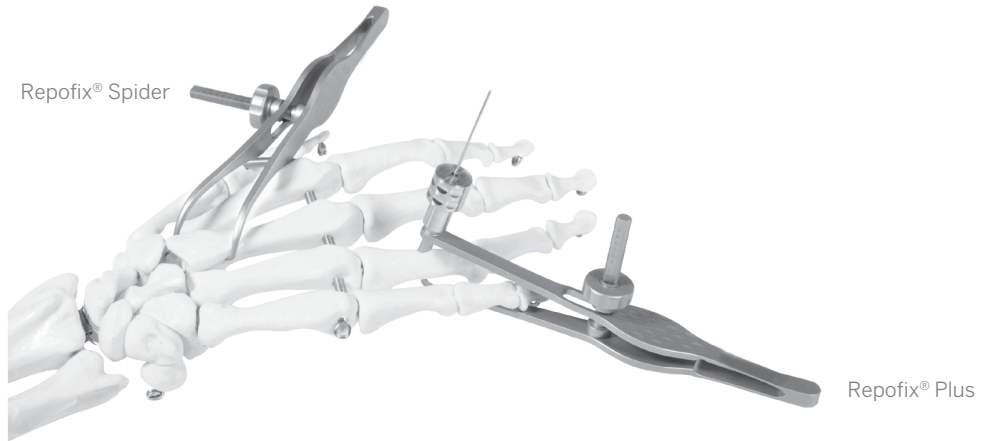

- Fine tips allow reduction in limited spaces
- Speed lock tightening wheel for controlled reduction
- Measuring scale



TWS 84-2032/53  
5 3/8" (137mm)  
50mm                      Maximum measurable bone width

Sterilization Tray  
TWS 84-2032/54                      Large enough to contain Repofix® Plus and Repofix® Spider

## REPOFIX® SPIDER



**TW**  
Surgical

## Treasure Wright (U.K.) Ltd.

---

**Address: 128-160 , City Road,  
London EC1V 2NX. United Kingdom**

---

[www.twrightmedical.com](http://www.twrightmedical.com)

[info@twrightmedical.com](mailto:info@twrightmedical.com)



TW Surgical



**UK  
CA CE**