



**TW**  
Surgical

# ENDOSCOPY



**UK  
CA** **CE**



TW Surgical

Treasure Wright (U.K.) Ltd.



[www.twrightmedical.com](http://www.twrightmedical.com)



[info@twrightmedical.com](mailto:info@twrightmedical.com)



**TWS 33154** Ø 2,9 mm ■

Diagnostic sheath with 1 rotatable stopcock, WL. 228 mm, round, for 0° Endoscopes

**TWS 33155** Ø 2,9 mm ■

Diagnostic sheath with 1 rotatable stopcock, WL. 228 mm, round, for 30° Endoscopes



**TWS 33156** ■

Obturator for diagnostic sheaths

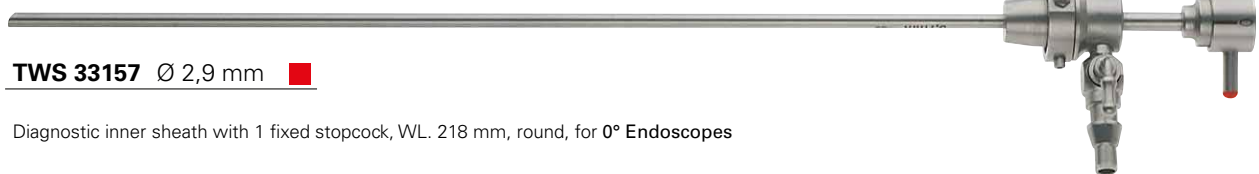

**TWS 33157** Ø 2,9 mm ■

Diagnostic inner sheath with 1 fixed stopcock, WL. 218 mm, round, for 0° Endoscopes

**TWS 33158** Ø 2,9 mm ■

Diagnostic inner sheath with 1 fixed stopcock, WL. 218 mm, round, for 30° Endoscopes



**TWS 33159** Ø 3,7 mm ■

Continuous flow outer sheath with 1 fixed stopcock, WL. 200 mm, round, for sheaths



Inner sheath mounted on outer sheath



**TWS 33160** ■

Operation inner sheath with 1 fixed stopcock, drop shape, instrument channel 5 Charr., for 30° Endoscopes



**TWS 33161** Ø 4,3 mm ■

Continuous flow outer sheath with 1 fixed stopcock, WL. 181 mm, drop shape



**TWS 33162** Ø 4,3 mm ■

Continuous flow operation sheath with 2 fixed stopcocks, WL. 173 mm, oval, instrument channel with stopcock 5 Charr., for 30° Endoscopes





**TWS 33163** Ø 4,0 mm

Diagnostic sheath with 1 rotatable stopcock, WL. 270 mm, round, for 0° Endoscopes

**TWS 33164** Ø 4,0 mm

Diagnostic sheath with 1 rotatable stopcock, WL. 270 mm, round, for 30° Endoscopes



**TWS 33165**

Obturator for diagnostic sheaths

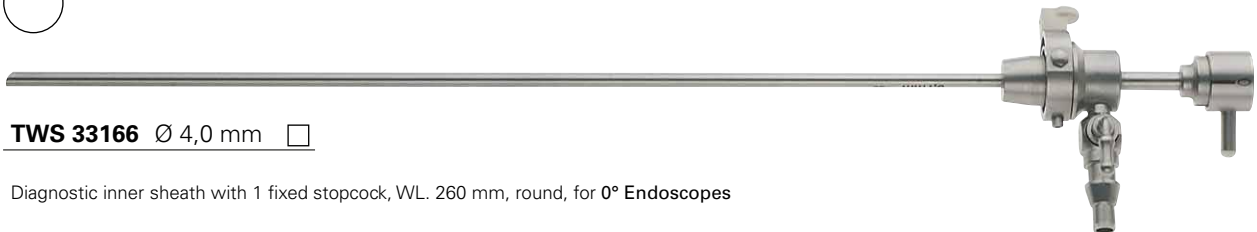

**TWS 33166** Ø 4,0 mm

Diagnostic inner sheath with 1 fixed stopcock, WL. 260 mm, round, for 0° Endoscopes

**TWS 33167** Ø 4,0 mm

Diagnostic inner sheath with 1 fixed stopcock, WL. 267 mm, round, for 30° Endoscopes



**TWS 33168** Ø 5,0 mm

Continuous flow outer sheath with 1 fixed stopcock, WL 240 mm, round, for sheaths

## Operation sheaths for Ø 2.7 / 2.9 mm Endoscopes



TW Surgical

 Inner sheath mounted on outer sheath



**TWS 33169**

Operation inner sheath with 1 fixed stopcock, drop shape, instrument channel 5 Charr., for 30° Endoscopes



**TWS 33170** Ø 5,0 mm

Continuous flow outer sheath with 1 fixed stopcock, WL. 192 mm, drop shape



**TWS 33171**

Obturator for outer sheath



**Treasure Wright (U.K.) Ltd.**

128-160 City Road, London, EC1V 2NX, United Kingdom  
info@twrightmedical.com



Inner sheath mounted on outer sheath

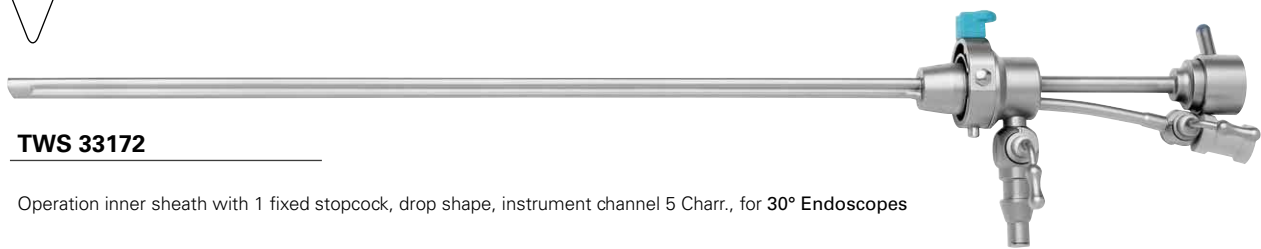
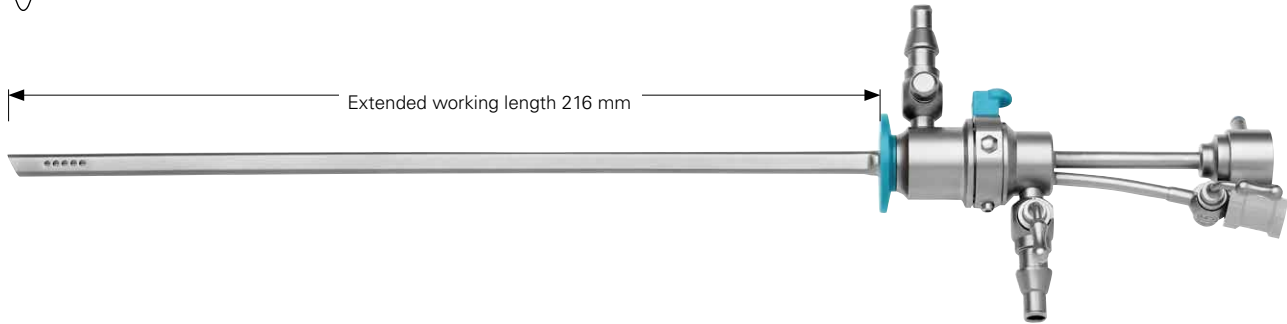

**TWS 33172**

Operation inner sheath with 1 fixed stopcock, drop shape, instrument channel 5 Charr., for 30° Endoscopes



**TWS 33173** Ø 5,0 mm ■

Continuous flow outer sheath with 1 fixed stopcock, WL. 216 mm, drop shape



**TWS 33174** ■

Obturator for outer sheath

# Operation sheaths for Ø 2.7 / 2.9 mm Endoscopes



Inner sheath mounted on outer sheath

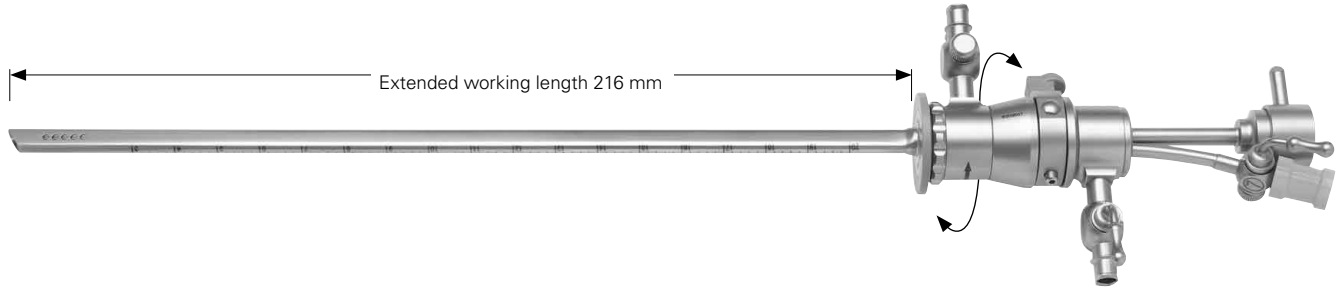

## TWS 33175

Operation inner sheath with 1 fixed stopcock, drop shape, instrument channel 7 Charr., for 30° Endoscopes

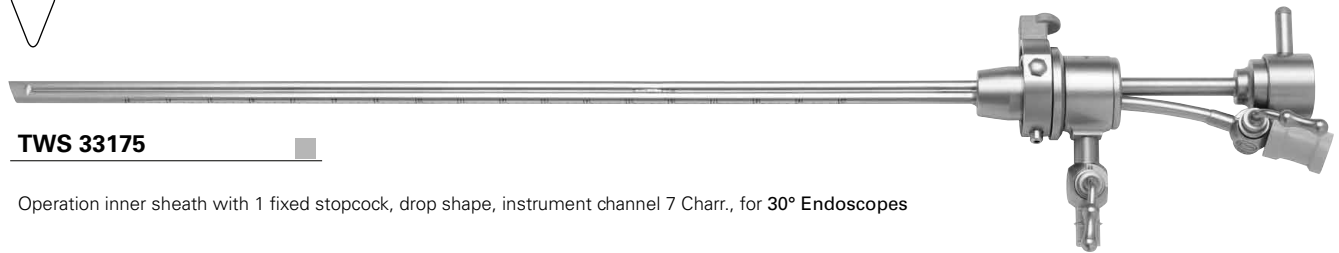

## TWS 33176 Ø 5,0 mm

Continuous flow outer sheath with 1 rotatable stopcock, WL. 216 mm, drop shape

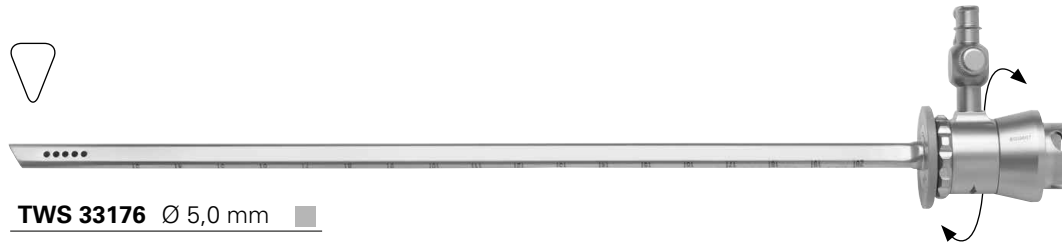



Inner sheath mounted on outer sheath

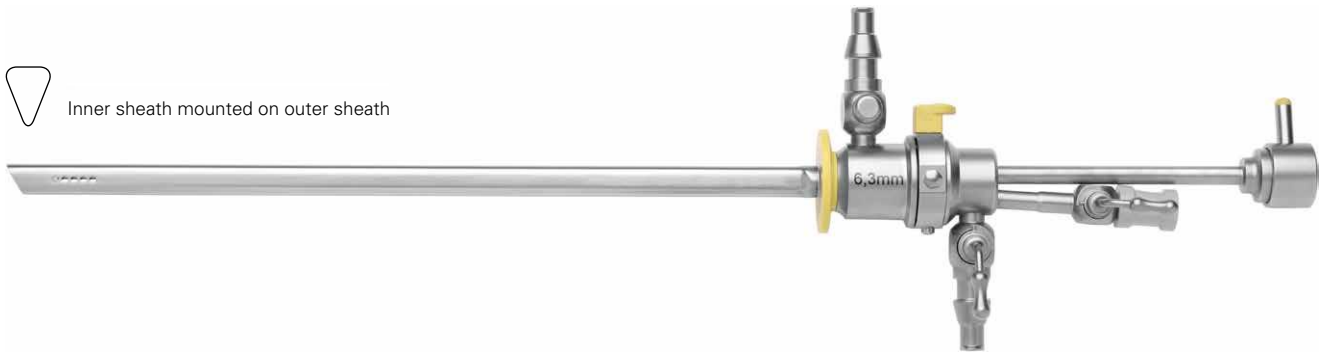

**TWS 33177** ■

Operation inner sheath with 1 fixed stopcock, drop shape, instrument channel 9 Charr., for 30° Endoscopes

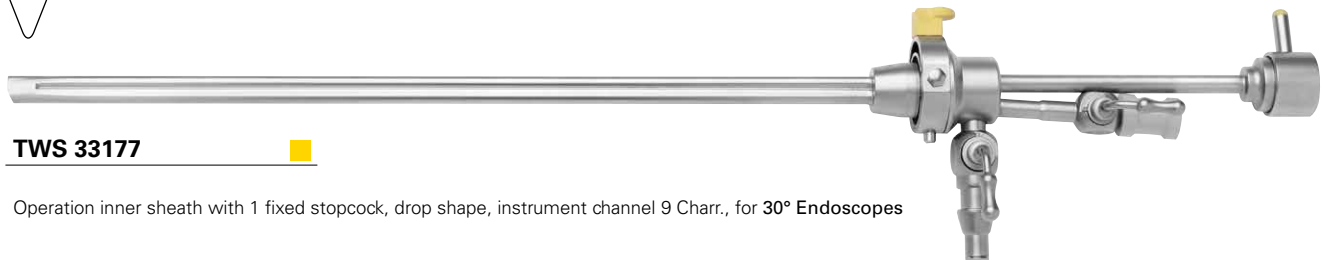

**TWS 33178** Ø 6,3 mm ■

Continuous flow outer sheath with 1 fixed stopcock, WL. 192 mm, drop shape





**TWS 33179** Ø 5,0 mm

Operation sheath with 2 fixed stopcocks, drop shape, WL. 248 mm, instrument channel 5 Charr., for 30° Endoscopes



**TWS 33180**

Obturator for operation sheath



### HIGH-FLOW

**TWS 33181** Ø 5,5 mm

Continuous flow operation sheath with 2 fixed stopcocks, WL. 212 mm, round, instrument channel with stopcock 5 Charr., for 12° / 30° Endoscopes



**TWS 33182** Ø 6,0 mm

Continuous flow operation sheath with 2 rotatable stopcocks, WL. 200 mm, round, instrument channel 5 Charr., for 0° Endoscopes

**TWS 33183** Ø 6,0 mm

Continuous flow operation sheath with 2 rotatable stopcocks, WL. 200 mm, round, instrument channel 5 Charr., for 30° Endoscopes

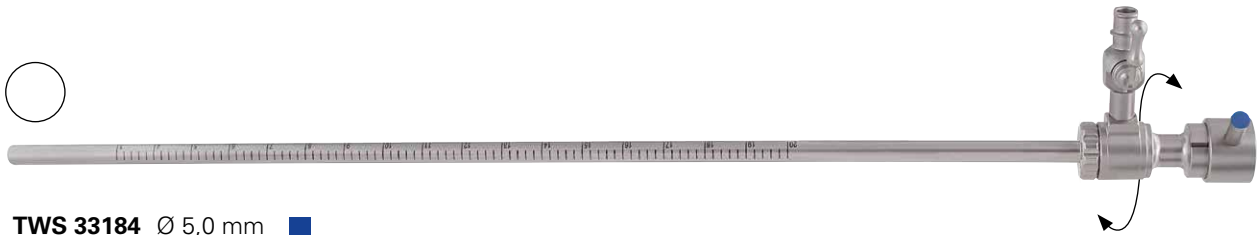

**TWS 33184** Ø 5,0 mm ■

Diagnostic sheath with 1 rotatable stopcock, WL. 270 mm, round, for 0° Endoscopes

**TWS 33185** Ø 5,0 mm ■

Diagnostic sheath with 1 rotatable stopcock, WL. 270 mm, round, for 30° Endoscopes



**TWS 33186** ■

Obturator for diagnostic sheaths

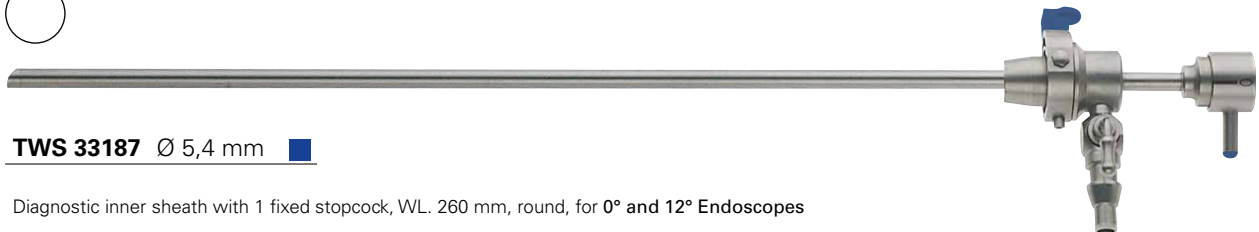

**TWS 33187** Ø 5,4 mm ■

Diagnostic inner sheath with 1 fixed stopcock, WL. 260 mm, round, for 0° and 12° Endoscopes

**TWS 33188** Ø 5,4 mm ■

Diagnostic inner sheath with 1 fixed stopcock, WL. 260 mm, round, for 12° and 30° Endoscopes



**TWS 33189** Ø 6,5 mm ■

Continuous flow outer sheath with 1 fixed stopcock, WL. 240 mm, round, for sheaths



Inner sheath mounted on outer sheath

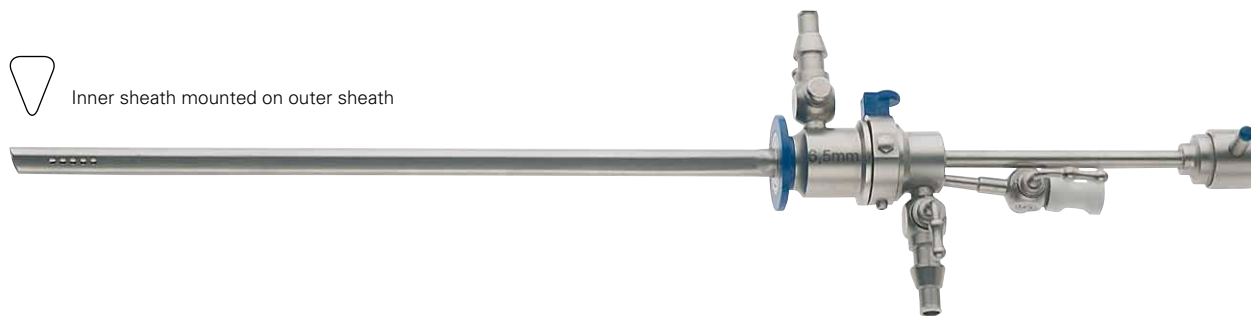

**TWS 33190** ■

Operation inner sheath with 1 fixed stopcock, drop shape, instrument channel 5 Charr., for 30° Endoscopes



**TWS 33191** Ø 6,5 mm ■

Continuous flow outer sheath with 1 fixed stopcock, WL. 192 mm, drop shape



# Operation sheaths for Ø 4.0 mm Endoscopes



Inner sheath mounted on outer sheath

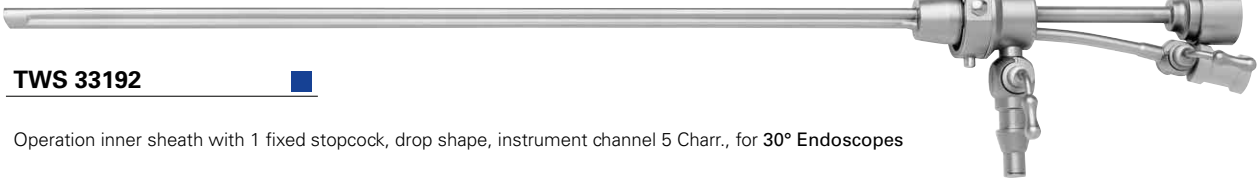
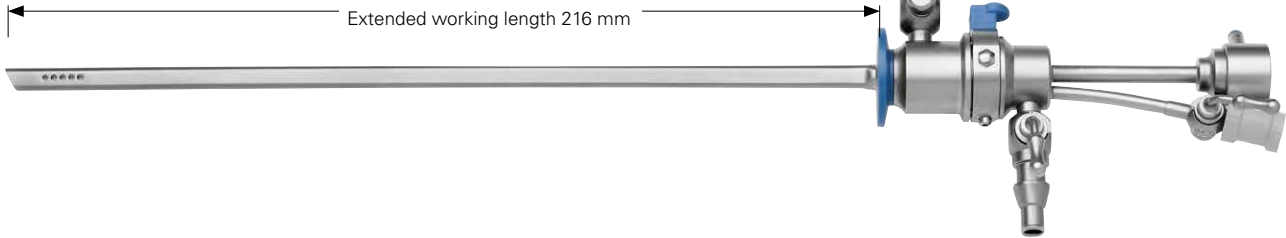

**TWS 33192** ■

Operation inner sheath with 1 fixed stopcock, drop shape, instrument channel 5 Charr., for 30° Endoscopes



**TWS 33193** Ø 6,5 mm ■

Continuous flow outer sheath with 1 fixed stopcock, WL. 216 mm, drop shape



Inner sheath mounted on outer sheath

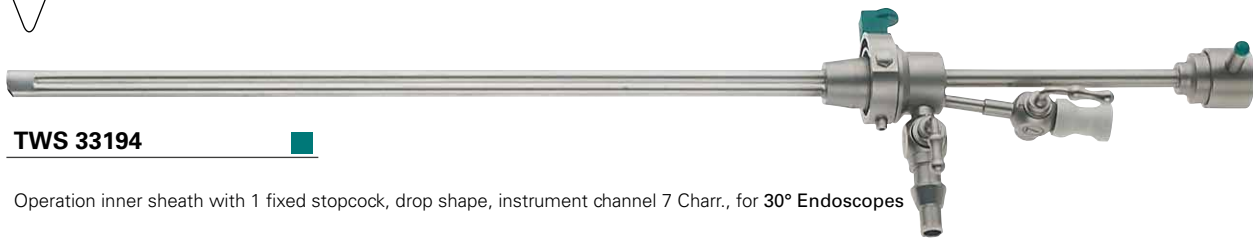

**TWS 33194** ■

Operation inner sheath with 1 fixed stopcock, drop shape, instrument channel 7 Charr., for 30° Endoscopes



**TWS 33195** Ø 7,0 mm ■

Continuous flow outer sheath with 1 fixed stopcock, WL. 192 mm, drop shape



**TWS 33196** ■

Obturator for outer sheath

○ Inner sheath mounted on outer sheath

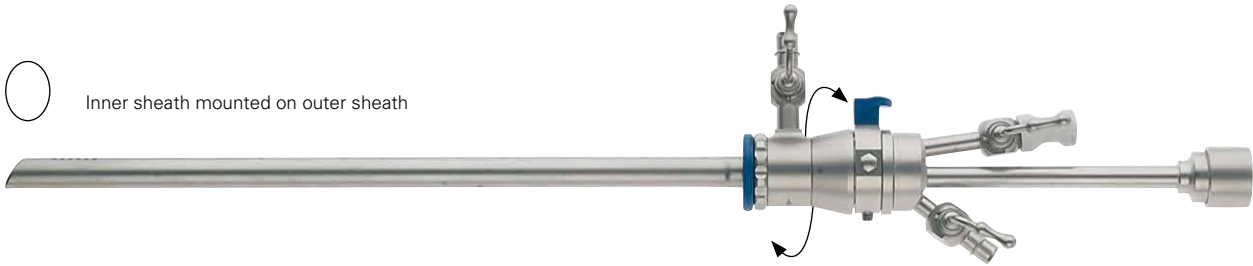

**TWS 33197** ■

Operation inner sheath with 1 fixed stopcock, oval, instrument channel 7 Charr., for 30° Endoscopes



**TWS 33198** Ø 7,0 mm ■

Dauerspül Außenschaft mit 1 drehbaren Hahn, NL. 182 mm, oval  
Continuous flow outer sheath with 1 rotatable stopcock, WL. 182 mm, oval



**TWS 33199** ■

Obturator for outer sheath

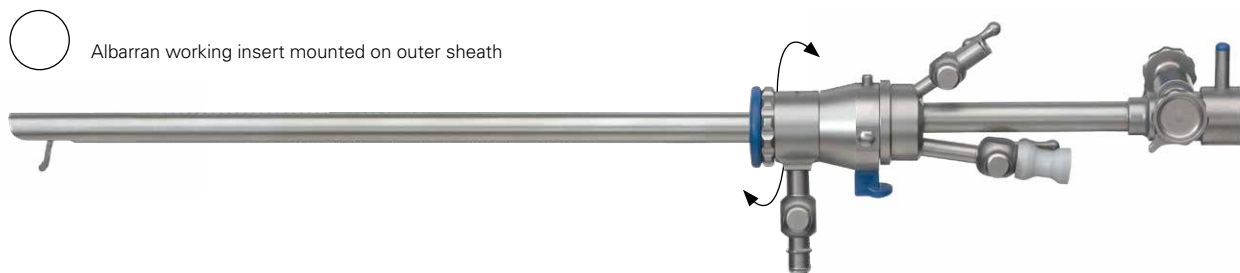

**TWS 33200** ■

Working insert with Albarran deflecting mechanism, with 1 fixed stopcock, instrument channel 7 Charr., for 0°, 12°, 30°, 70° Endoscopes



**TWS 33201** Ø 8,0 mm ■

Continuous flow outer sheath with 1 rotatable stopcock, WL. 180 mm, round



**TWS 33202** ■

Obturator for outer sheath



**TWS 33203** Ø 7,5 mm ■

Continuous flow operation sheath with rotatable double stopcock, WL. 213.5 mm, round, instrument channel 7 Charr., for 0° Endoscopes

**TWS 33204** Ø 7,5 mm ■

Continuous flow operation sheath with rotatable double stopcock, WL. 214.5 mm, round, instrument channel 7 Charr., for 30° Endoscopes



**TWS 33205** Ø 8,0 mm ■





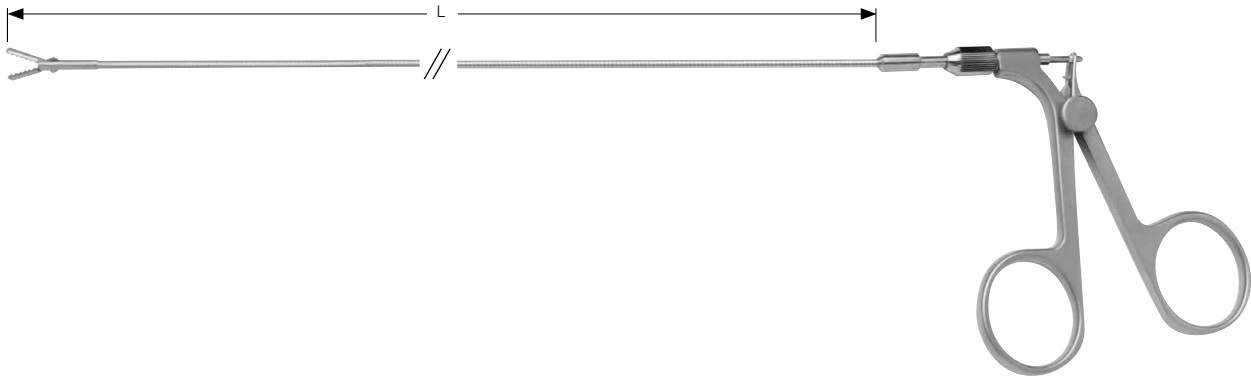

Continuous flow operation sheath with 2 rotatable stopcocks, WL. 200 mm, round, instrument channel 7 Charr., for 0° Endoscopes

**TWS 33206** Ø 8,0 mm ■

Continuous flow operation sheath with 2 rotatable stopcocks, WL. 200 mm, round, instrument channel 7 Charr., for 30° Endoscopes

## Flexible and Semi-rigid instruments



	Version	Ø	Length	Flexible	Semi-rigid
		3 Charr.	400 mm	<b>TWS 33207</b>	<b>TWS 33209</b>
		5 Charr.	400 mm	<b>TWS 33208</b>	<b>TWS 33210</b>
		7 Charr.	400 mm	<b>TWS 33211</b>	<b>TWS 33213</b>
		9 Charr.	400 mm	<b>TWS 33212</b>	<b>TWS 33214</b>
		3 Charr.	400 mm	<b>TWS 33215</b>	<b>TWS 33219</b>
		5 Charr.	400 mm	<b>TWS 33216</b>	<b>TWS 33220</b>
		7 Charr.	400 mm	<b>TWS 33217</b>	<b>TWS 33221</b>
		9 Charr.	400 mm	<b>TWS 33218</b>	<b>TWS 33222</b>
		3 Charr.	400 mm		
		5 Charr.	400 mm	<b>TWS 33223</b>	<b>TWS 33226</b>
		7 Charr.	400 mm	<b>TWS 33224</b>	<b>TWS 33227</b>
		9 Charr.	400 mm	<b>TWS 33225</b>	<b>TWS 33228</b>
		3 Charr.	400 mm	<b>TWS 33229</b>	<b>TWS 33234</b>
		5 Charr.	400 mm	<b>TWS 33230</b>	<b>TWS 33235</b>
		7 Charr.	400 mm	<b>TWS 33231</b>	<b>TWS 33236</b>
		9 Charr.	400 mm	<b>TWS 33232</b>	<b>TWS 33233</b>
		3 Charr.	400 mm		
		5 Charr.	400 mm		<b>TWS 33237</b>
		7 Charr.	400 mm		<b>TWS 33238</b>
		9 Charr.	400 mm		
		3 Charr.	400 mm		
		5 Charr.	400 mm	<b>TWS 33239</b>	<b>TWS 33233</b>
		7 Charr.	400 mm	<b>TWS 33240</b>	<b>TWS 33232</b>
		9 Charr.	400 mm		<b>TWS 33231</b>

Other lengths, diameters and jaw parts available on request.

## Semi-rigid instruments with Luer-Lock rinsing channel



TW Surgical

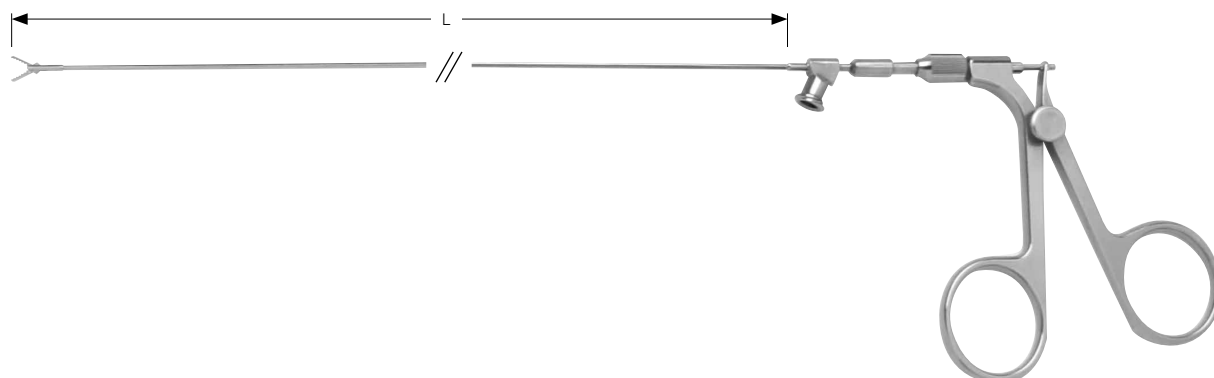

	Version	∅	Length	Semi-rigid
	Alligator Grasping forceps, double action	3 Charr.	400 mm	<b>TWS 33234 LL</b>
		5 Charr.	400 mm	<b>TWS 33235 LL</b>
	Alligator Grasping forceps, double action	7 Charr.	400 mm	<b>TWS 33236 LL</b>
		9 Charr.	400 mm	<b>TWS 33237 LL</b>
	Biospy forceps, spoon oval, double action	3 Charr.	400 mm	<b>TWS 33238 LL</b>
		5 Charr.	400 mm	<b>TWS 33239 LL</b>
		7 Charr.	400 mm	<b>TWS 33240 LL</b>
		9 Charr.	400 mm	<b>TWS 33241 LL</b>
	Biospy forceps, spoon oval, toothed, double action	3 Charr.	400 mm	
		5 Charr.	400 mm	<b>TWS 33242 LL</b>
		7 Charr.	400 mm	<b>TWS 33243 LL</b>
		9 Charr.	400 mm	<b>TWS 33244 LL</b>
	Scissors, blunt, single action	3 Charr.	400 mm	
		5 Charr.	400 mm	<b>TWS 33245 LL</b>
		7 Charr.	400 mm	<b>TWS 33246 LL</b>
		9 Charr.	400 mm	<b>TWS 33247 LL</b>
	Scissors, pointed, single action	3 Charr.	400 mm	
		5 Charr.	400 mm	<b>TWS 33248 LL</b>
		7 Charr.	400 mm	<b>TWS 33249 LL</b>
		9 Charr.	400 mm	
	Hook Scissors, single action	3 Charr.	400 mm	
		5 Charr.	400 mm	<b>TWS 33250 LL</b>
		7 Charr.	400 mm	<b>TWS 33251 LL</b>
		9 Charr.	400 mm	<b>TWS 33252 LL</b>







Other lengths, diameters and jaw parts available on request.

**Treasure Wright (U.K.) Ltd.**



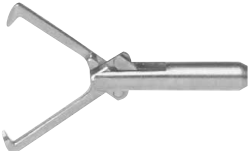

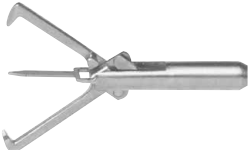

128-160 City Road, London, EC1V 2NX, United Kingdom  
 info@twrightmedical.com

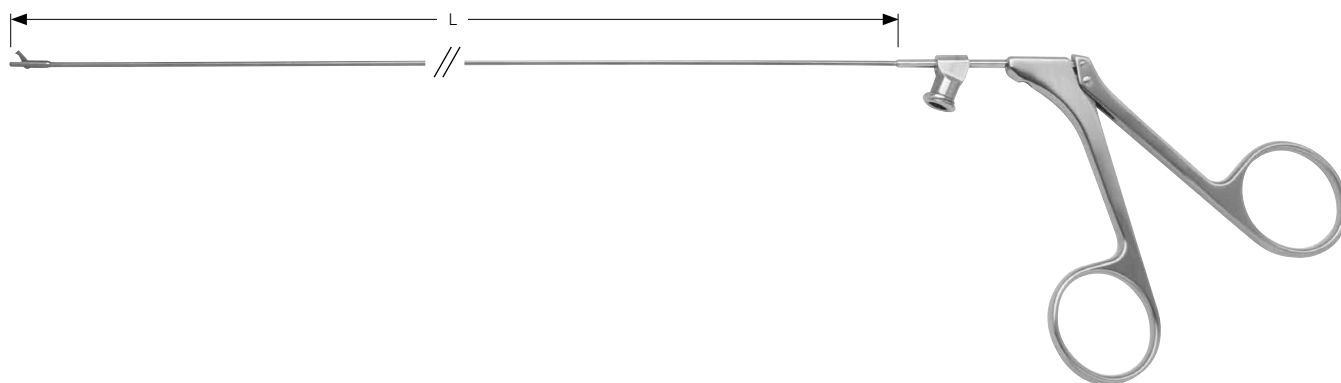
## Semi-rigid instruments with Luer-Lock rinsing channel



	Version	Ø	Length 340 mm	Length 400 mm
	Biopsy punch, through-cutting, semi-rigid, single action	5 Charr.	<b>TWS 33253 LL</b>	<b>TWS 33254 LL</b>
	Biopsy forceps, spoon oval, semi-rigid, double action	5 Charr.	<b>TWS 33255 LL</b>	<b>TWS 33256 LL</b>
	Tenaculum grasping forceps, semi-rigid, double action	5 Charr.	<b>TWS 33257 LL</b>	<b>TWS 33258 LL</b>
	Biopsy and grasping forceps, semi-rigid, double action	5 Charr.	<b>TWS 33259 LL</b>	<b>TWS 33260 LL</b>
	Scissors, pointed, semi-rigid, single action	5 Charr.	<b>TWS 33261 LL</b>	<b>TWS 33263 LL</b>
	Scissors, blunt, semi-rigid, single action	5 Charr.	<b>TWS 33262 LL</b>	<b>TWS 33264 LL</b>
	Tenaculum grasping forceps with spike, semi-rigid, double action	5 Charr.	<b>TWS 33265 LL</b>	<b>TWS 33266 LL</b>



	Version	Ø	Length
	Biopsy punch, through-cutting, semi-rigid, single action	7 Charr.	<b>400 mm</b> <b>TWS 33267 LL</b>
	Biopsy forceps, spoon oval, semi-rigid, double action	7 Charr.	<b>TWS 33268 LL</b>
	Alligator grasping forceps, semi-rigid, double action	7 Charr.	<b>TWS 33269 LL</b>
	Scissors, pointed, semi-rigid, single action	7 Charr.	<b>TWS 33270 LL</b>
	Scissors, blunt, semi-rigid, single action	7 Charr.	<b>TWS 33271 LL</b>
	Hook scissors, semi-rigid, single action	7 Charr.	<b>TWS 33272 LL</b>

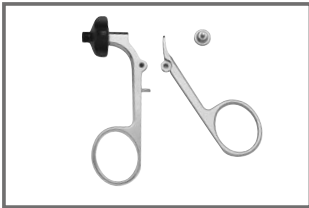
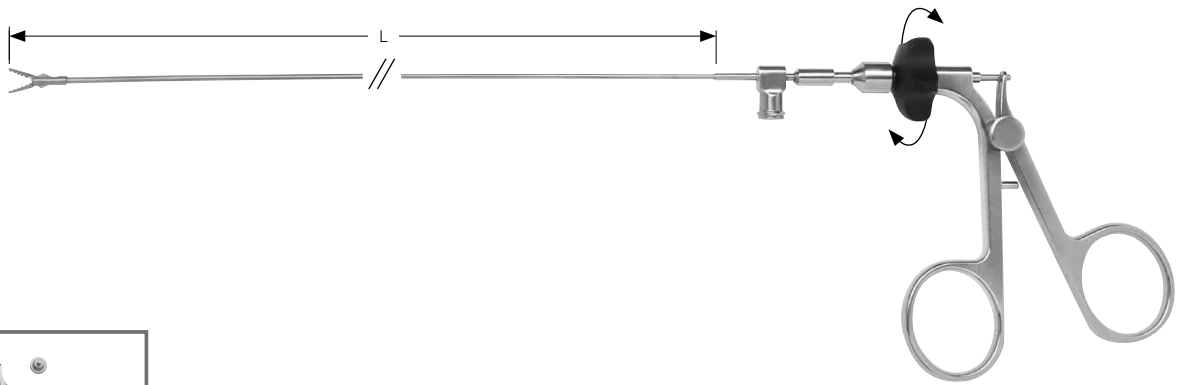

Stainless steel handle can be easily removed and detached for better cleaning.



Integrated overload protection for a significantly longer service life.

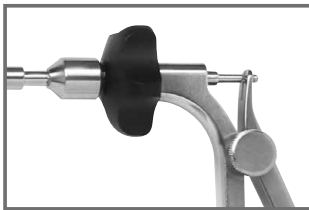

360° rotatable shaft is smoothly to adjust and with a haptic feedback while rotating.

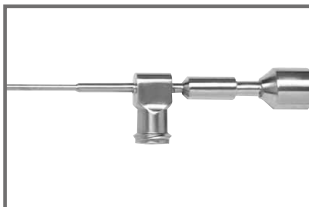

Cleaning port Luer-Lock for an easier and faster cleaning without removing the handle.

**TWS 33273 MH**

HyONE Handle with rotating wheel and overload protection, stainless steel



# HyONE Rotat- and detachable semi-rigid instruments WL. 340 mm



TW Surgical

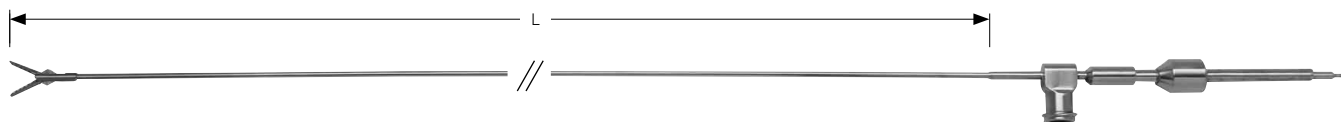

	Version	Ø	Length	Insert, only	Complete with handle
	Alligator Grasping forceps, double action	4 Charr.	340 mm	<b>TWS 33274 MI</b>	<b>TWS 33277 MC</b>
		5 Charr.	340 mm	<b>TWS 33275 MI</b>	<b>TWS 33278 MC</b>
		7 Charr.	340 mm	<b>TWS 33276 MI</b>	<b>TWS 33279 MC</b>
	Biology forceps, spoon oval, double action	4 Charr.	340 mm	<b>TWS 33280 MI</b>	<b>TWS 33283 MC</b>
		5 Charr.	340 mm	<b>TWS 33281 MI</b>	<b>TWS 33284 MC</b>
		7 Charr.	340 mm	<b>TWS 33282 MI</b>	<b>TWS 33285 MC</b>
	Biology forceps, spoon oval, toothed, double action	4 Charr.	340 mm		
		5 Charr.	340 mm	<b>TWS 33286 MI</b>	<b>TWS 33288 MC</b>
		7 Charr.	340 mm	<b>TWS 33287 MI</b>	<b>TWS 33289 MC</b>
	Scissors, blunt, single action	4 Charr.	340 mm	<b>TWS 33290 MI</b>	<b>TWS 33293 MC</b>
		5 Charr.	340 mm	<b>TWS 33291 MI</b>	<b>TWS 33294 MC</b>
		7 Charr.	340 mm	<b>TWS 33292 MI</b>	<b>TWS 33295 MC</b>
	Scissors, pointed, single action	4 Charr.	340 mm	<b>TWS 33296 MI</b>	<b>TWS 33299 MC</b>
		5 Charr.	340 mm	<b>TWS 33297 MI</b>	<b>TWS 33300 MC</b>
		7 Charr.	340 mm	<b>TWS 33298 MI</b>	<b>TWS 33301 MC</b>
	Hook Scissors, single action	4 Charr.	340 mm		
		5 Charr.	340 mm	<b>TWS 33302 MI</b>	<b>TWS 33306 MC</b>
		7 Charr.	340 mm	<b>TWS 33303 MI</b>	<b>TWS 33307 MC</b>
	Biology punch, through-cutting, single action	4 Charr.	340 mm		
		5 Charr.	340 mm	<b>TWS 33304 MI</b>	<b>TWS 33308 MC</b>
		7 Charr.	340 mm	<b>TWS 33305 MI</b>	<b>TWS 33309 MC</b>

Other lengths, diameters and jaw parts available on request.

Treasure Wright (U.K.) Ltd.

128-160 City Road, London, EC1V 2NX, United Kingdom  
info@twrightmedical.com

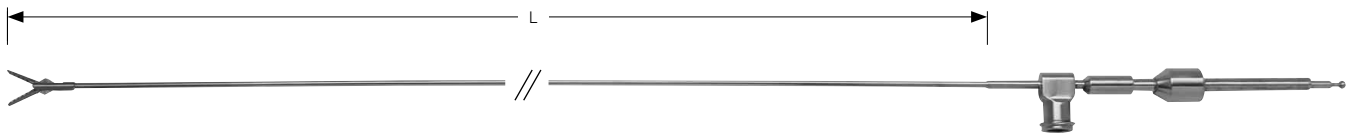

	Version	Ø	Length	Insert, only	Complete with handle
		4 Charr.	400 mm	<b>TWS 33310 MI</b>	<b>TWS 33316 MC</b>
	Alligator Grasping forceps, double action	5 Charr.	400 mm	<b>TWS 33311 MI</b>	<b>TWS 33318 MC</b>
		7 Charr.	400 mm	<b>TWS 33312 MI</b>	<b>TWS 33317 MC</b>
		4 Charr.	400 mm	<b>TWS 33313 MI</b>	<b>TWS 33319 MC</b>
	Biospy forceps, spoon oval, double action	5 Charr.	400 mm	<b>TWS 33314 MI</b>	<b>TWS 33320 MC</b>
		7 Charr.	400 mm	<b>TWS 33315 MI</b>	<b>TWS 33321 MC</b>
		4 Charr.	400 mm		
	Biospy forceps, spoon oval, toothed, double action	5 Charr.	400 mm	<b>TWS 33322 MI</b>	<b>TWS 33324 MC</b>
		7 Charr.	400 mm	<b>TWS 33323 MI</b>	<b>TWS 33325 MC</b>
		4 Charr.	400 mm	<b>TWS 33326 MI</b>	<b>TWS 33329 MC</b>
	Scissors, blunt, single action	5 Charr.	400 mm	<b>TWS 33327 MI</b>	<b>TWS 33330 MC</b>
		7 Charr.	400 mm	<b>TWS 33328 MI</b>	<b>TWS 33331 MC</b>
		4 Charr.	400 mm	<b>TWS 33332 MI</b>	<b>TWS 33335 MC</b>
	Scissors, pointed, single action	5 Charr.	400 mm	<b>TWS 33333 MI</b>	<b>TWS 33336 MC</b>
		7 Charr.	400 mm	<b>TWS 33334 MI</b>	<b>TWS 33337 MC</b>
		4 Charr.	400 mm		
	Hook Scissors, single action	5 Charr.	400 mm	<b>TWS 33338 MI</b>	<b>TWS 33340 MC</b>
		7 Charr.	400 mm	<b>TWS 33339 MI</b>	<b>TWS 33341 MC</b>
		4 Charr.	400 mm		
	Biospy punch, through-cutting, single action	5 Charr.	400 mm	<b>TWS 33342 MI</b>	<b>TWS 33344 MC</b>
		7 Charr.	400 mm	<b>TWS 33343 MI</b>	<b>TWS 33345 MC</b>

Other lengths, diameters and jaw parts available on request.



**TWS 33346** 5 Charr.

Palpation probe, graduated, WL 340 mm, semi-rigid

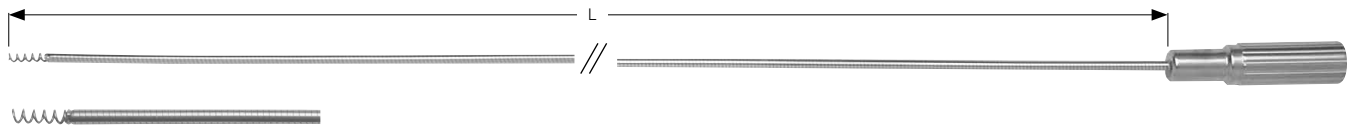



**TWS 33347** 5 Charr.

Myoma fixation screw, WL 340 mm, semi-rigid

# Flexible monopolar and bipolar electrodes



Version	Ø	Length		
		450 mm	650 mm	
 Button tip electrode	3 Charr.	<b>TWS 33348</b>	<b>TWS 33349</b>	
	4 Charr.	<b>TWS 33350</b>	<b>TWS 33364</b>	
	5 Charr.	<b>TWS 33355</b>	<b>TWS 33365</b>	
	6 Charr.	<b>TWS 33356</b>	<b>TWS 33366</b>	
	7 Charr.	<b>TWS 33357</b>	<b>TWS 33367</b>	
	8 Charr.	<b>TWS 33358</b>	<b>TWS 33368</b>	
	9 Charr.	<b>TWS 33359</b>	<b>TWS 33369</b>	
	10 Charr.	<b>TWS 33360</b>	<b>TWS 33370</b>	
	 Needle electrode	3 Charr.	<b>TWS 33352</b>	<b>TWS 33361</b>
		5 Charr.	<b>TWS 33353</b>	<b>TWS 33362</b>
7 Charr.		<b>TWS 33354</b>	<b>TWS 33363</b>	
 Loop electrode	5 Charr.	<b>TWS 33371</b>	<b>TWS 33375</b>	
	7 Charr.	<b>TWS 33372</b>	<b>TWS 33377</b>	
	9 Charr.	<b>TWS 33373</b>	<b>TWS 33379</b>	
	10 Charr.	<b>TWS 33374</b>	<b>TWS 33376</b>	

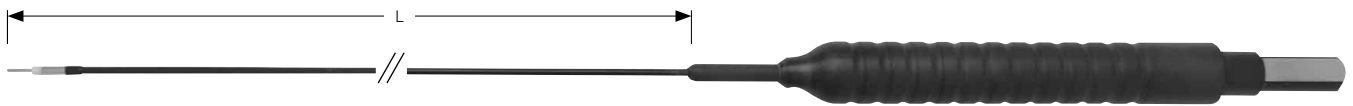

**TWS 33380** 5 Charr.      **TWS 33381** 5 Charr.      **TWS 33382** 5 Charr.      **TWS 33383** 5 Charr.

Button tip electrode, WL 360 mm      Needle electrode, angled, WL 360 mm      Needle electrode, straight, WL 360 mm      Needle electrode, 90° angled, WL 360 mm

**Treasure Wright (U.K.) Ltd.**

128-160 City Road, London, EC1V 2NX, United Kingdom  
info@twrightmedical.com

Semi-rigid electrodes, flexible Diathermy loops

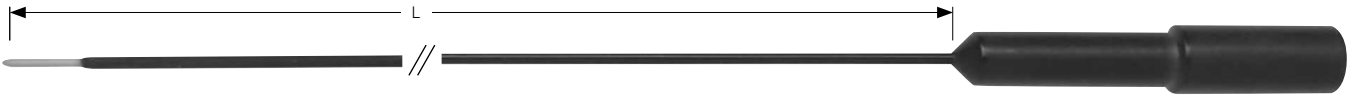

**TWS 33384** 5 Charr.

Ball electrode, WL. 340 mm, semi-rigid



**TWS 33385** 5 Charr.

Needle electrode, WL. 340 mm, semi-rigid

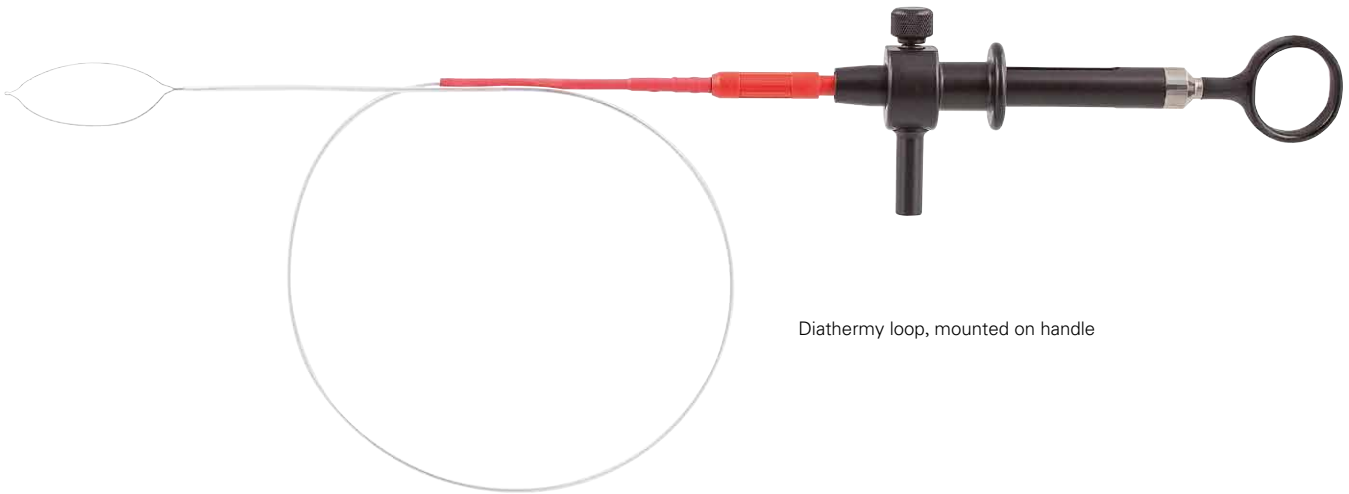

Diathermy loop, mounted on handle

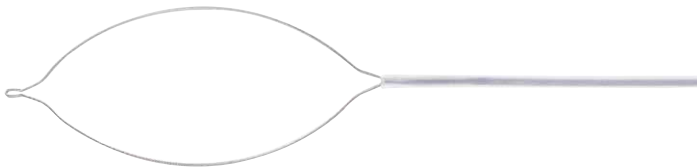

**TWS 33386** 5 Charr.

**TWS 33387** 7 Charr.

Diathermy loops with Teflon tube, WL 600 mm



**TWS 33388** 5 / 7 Charr.

Handle with HF-connection

# Monopolar and bipolar connecting cables

Monopolar connecting cable with round plug



Plug instrument side

	Length	Item number
Ø 4 mm	3,0 m	<b>TWS 33389</b>
	5,0 m	<b>TWS 33390</b>
Ø 5 mm	3,0 m	<b>TWS 33391</b>
	5,0 m	<b>TWS 33392</b>
Ø 8 mm	3,0 m	<b>TWS 33393</b>
	5,0 m	<b>TWS 33394</b>

Bipolar connecting cables with flat plug

Plug instrument side



Flat plug, square

Flat plug, round

	Length	Item number	
	3,0 m	<b>TWS 33395</b>	<b>TWS 33397</b>
	5,0 m	<b>TWS 33396</b>	<b>TWS 33398</b>
28,2 mm	3,0 m	<b>TWS 33399</b>	<b>TWS 33401</b>
	5,0 m	<b>TWS 33400</b>	<b>TWS 33402</b>
Ø 7,8 mm	3,0 m	<b>TWS 33403</b>	<b>TWS 33405</b>
	5,0 m	<b>TWS 33404</b>	<b>TWS 33406</b>
Ø 12,3 mm	3,0 m	<b>TWS 33407</b>	<b>TWS 33409</b>
	5,0 m	<b>TWS 33408</b>	<b>TWS 33410</b>

Treasure Wright (U.K.) Ltd.

! Working elements could be supplied with open handle as well as downside positioned HF-connection



**TWS 33411** 19 Charr.   
**TWS 33412** 24 Charr.

Monopolar working element, passive cutting, single stem, closed handle



**TWS 33413** 19 Charr.   
**TWS 33414** 24 Charr.

Monopolar working element, active cutting, single stem, closed handle

Monopolar single stem electrodes



- TWS 33415** 19 Charr.
- TWS 33416** 24 Charr.
- TWS 33417** 27 Charr.

Loop electrode, 30° angled



- TWS 33418** 19 Charr.
- TWS 33419** 24 Charr.
- TWS 33420** 27 Charr.

Loop electrode, straight



- TWS 33421** 24 Charr.
- TWS 33422** 27 Charr.

Loop electrode, 90° angled, for 0° endoscopes



- TWS 33423** 19 Charr.
- TWS 33424** 24 Charr.
- TWS 33425** 27 Charr.

Knife electrode, 90° angled



- TWS 33426** 24 Charr.
- TWS 33427** 27 Charr.

Cone electrode



- TWS 33428** 19 Charr.
- TWS 33429** 24 Charr.
- TWS 33430** 27 Charr.

Ball electrode, Ø 3.0 mm



- TWS 33431** 24 Charr.
- TWS 33432** 27 Charr.

Ball electrode, Ø 5.0 mm



- TWS 33432** 19 Charr.
- TWS 33433** 24 Charr.
- TWS 33434** 27 Charr.

Roller electrode, smooth, Ø 3.0 mm



- TWS 33435** 24 Charr.
- TWS 33436** 27 Charr.

Roller electrode, smooth, Ø 5.0 mm



- TWS 33437** 24 Charr.
- TWS 33438** 27 Charr.

Vaporisation electrode, serrated, Ø 3.0 mm



- TWS 33439** 24 Charr.
- TWS 33440** 27 Charr.

Vaporisation electrode, serrated, Ø 5.0 mm



- TWS 33441** 24 Charr.

Cut-vaporisation electrode



**TWS 33442**

Sterilisation tube for resectoscopy electrodes

## Resectoscopy sheaths

Resectoscopy continuous flow sheaths with 2 stopcocks, **fixed inner sheath**, surround perforation



Size	Colour code	Complete with obturator	Inner sheath, only	Outer sheath, only	Obturator, only
22 Charr.	<input type="checkbox"/>	<b>TWS 33443</b>	<b>TWS 33451</b> 19 Charr.	<b>TWS 33445</b>	<b>TWS 33448</b>
26 Charr.	<input checked="" type="checkbox"/>	<b>TWS 33444</b>	<b>TWS 33452</b> 24 Charr.	<b>TWS 33446</b>	<b>TWS 33449</b>
28,5 Charr.	<input checked="" type="checkbox"/>	<b>TWS 33444</b>	<b>TWS 33453</b> 27 Charr.	<b>TWS 33447</b>	<b>TWS 33450</b>

Resectoscopy continuous flow sheaths with 2 stopcocks, **rotatable inner sheath**, surround perforation



Size	Colour code	Complete with obturator	Inner sheath, only	Outer sheath, only	Obturator, only
22 Charr.	<input type="checkbox"/>	<b>TWS 33451</b>	<b>TWS 33453</b> 19 Charr.	<b>TWS 33454</b>	<b>TWS 33457</b>
26 Charr.	<input checked="" type="checkbox"/>	<b>TWS 33452</b>	<b>TWS 33462</b> 24 Charr.	<b>TWS 33455</b>	<b>TWS 33458</b>
28,5 Charr.	<input checked="" type="checkbox"/>	<b>TWS 33453</b>	<b>TWS 33460</b> 27 Charr.	<b>TWS 33456</b>	<b>TWS 33459</b>

Treasure Wright (U.K.) Ltd.



- TWS 33460** 19 Charr.
- TWS 33461** 24 Charr.
- TWS 33462** 27 Charr.

Standard obturator for resectoscopy sheaths



- TWS 33463** 19 Charr.
- TWS 33464** 24 Charr.
- TWS 33465** 27 Charr.

Visual obturator for resectoscopy sheaths



- TWS 33466** 24 Charr.  Kanal I Channel = 5 Charr.
- TWS 33467** 27 Charr.  Kanal I Channel = 7 Charr.

Visual obturator with instrument channel for resectoscopy sheaths





- TWS 33468** 24 Charr.
- TWS 33469** 27 Charr.

Deflecting obturator for resectoscopy sheaths

Monopolar connecting cables with round plug



Plug instrument side

	Length	Item number
 Ø 4 mm	3,0 m	<b>TWS 33470</b>
	5,0 m	<b>TWS 33471</b>
 Ø 5 mm	3,0 m	<b>TWS 33472</b>
	5,0 m	<b>TWS 33473</b>
 Ø 8 mm	3,0 m	<b>TWS 33474</b>
	5,0 m	<b>TWS 33475</b>

## Loops / Knives for cold myoma enucleation (non-electrical)

Mechanical cutting single stem instruments for **non-electrical** use with working elements and resectoscopy sheaths



**TWS 33476** 24 Charr.

Loop, straight, rectangular



**TWS 33477** 24 Charr.

Loop, straight, round



**TWS 33478** 24 Charr.

Knife, 45° angled



**TWS 33479** 24 Charr.

Knife, straight



**TWS 33480** 24 Charr.

Knife, H-shape, 90° angled

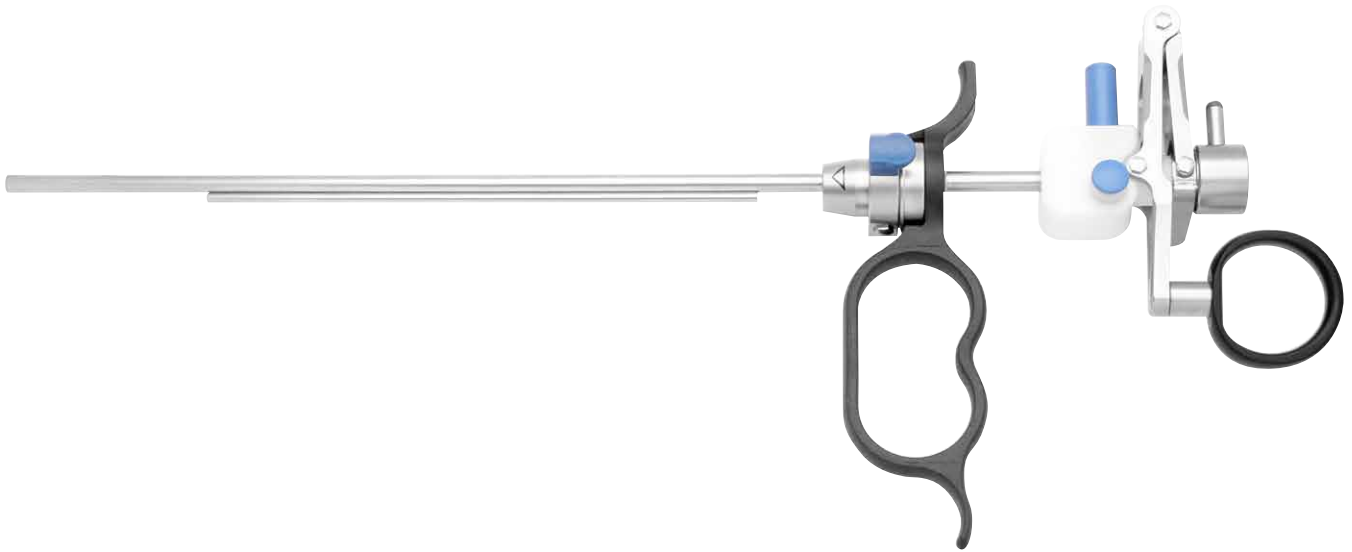

### QUICK-LOCK

- TWS 33481** 19 Charr.  for Endoscopes Ø 2,7 / 2,9 mm  
**TWS 33482** 24 Charr.  for Endoscopes Ø 4,0 mm

Bipolar working element, passive cutting, single stem, closed handle



### QUICK-LOCK

- TWS 33483** 19 Charr.  for Endoscopes Ø 2,7 / 2,9 mm  
**TWS 33484** 24 Charr.  for Endoscopes Ø 4,0 mm

Bipolar working element, active cutting, single stem, closed handle

## Bipolar / Saline resectoscopy electrodes

Bipolar single stem electrodes



**TWS 33485** 19 Charr.

**TWS 33486** 24 Charr.

**TWS 33487** 24 Charr. PI

Loop electrode, 30° angled



**TWS 33488** 19 Charr.

**TWS 33489** 24 Charr.

Loop electrode, straight



**TWS 33490** 19 Charr.

**TWS 33491** 24 Charr.

Loop electrode, 90° angled,  
for 0° endoscopes



**TWS 33493** 19 Charr.

**TWS 33494** 24 Charr.

Knife electrode, 90° angled



**TWS 33495** 24 Charr.

Cone electrode



**TWS 33496** 19 Charr.

**TWS 33497** 24 Charr.

Ball electrode, Ø 3.0 mm



**TWS 33498** 19 Charr.

**TWS 33499** 24 Charr.

Roller electrode, smooth, Ø 3.0 mm



**TWS 33500** 24 Charr.

Vaporisation electrode, serrated, Ø 3.0 mm



**TWS 33501** 24 Charr.

Vaporisation electrode, serrated, Ø 5.0 mm



### **TWS 33502**

Sterilisation tube for resectoscopy electrodes

Resectoscopy continuous flow sheaths with 2 stopcocks, **rotatable inner sheath**, surround perforation

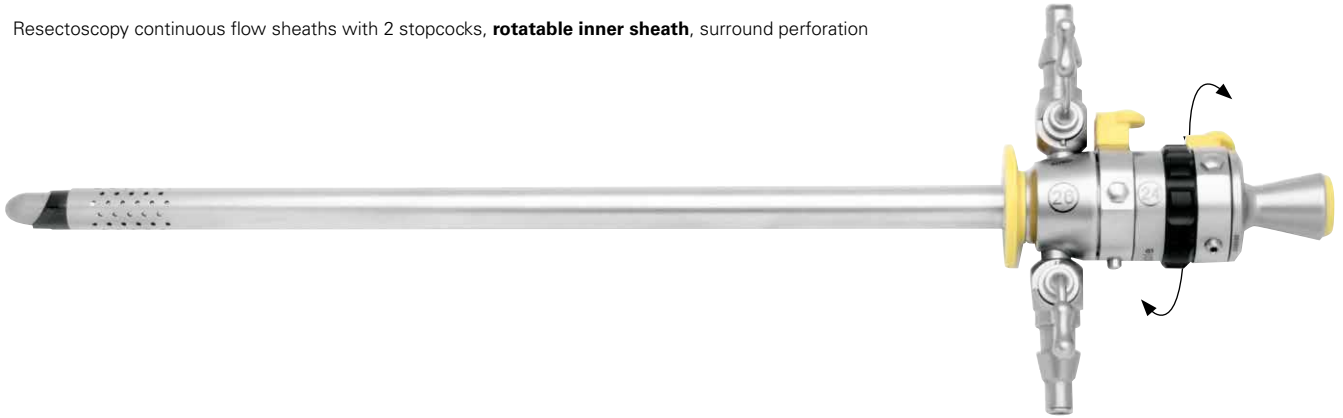

**QUICK-LOCK**

Size	Colour code	Complete with obturator	Inner sheath, only	Outer sheath, only	Obturator, only
22 Charr.	<input type="checkbox"/>	<b>TWS 33503</b>	<b>TWS 33509</b> 19 Charr	<b>TWS 33505</b>	<b>TWS 33507</b>
26 Charr.	<input checked="" type="checkbox"/>	<b>TWS 33504</b>	<b>TWS 33510</b> 24 Charr	<b>TWS 33506</b>	<b>TWS 33508</b>



**QUICK-LOCK**

<b>TWS 33511</b> 19 Charr.	<input type="checkbox"/>
<b>TWS 33512</b> 24 Charr.	<input checked="" type="checkbox"/>

Standard obturator for Bipolar resectoscopy sheaths



**QUICK-LOCK**

<b>TWS 33513</b> 19 Charr.	<input type="checkbox"/>
<b>TWS 33514</b> 24 Charr.	<input checked="" type="checkbox"/>

Visual obturator for Bipolar resectoscopy sheaths



**QUICK-LOCK**



<b>TWS 33515</b> 24 Charr.	<input checked="" type="checkbox"/>	Kanal I Channel = 6 Charr.
----------------------------	-------------------------------------	----------------------------

Visual obturator with instrument channel for Bipolar resectoscopy sheaths

## Bipolar connecting cables

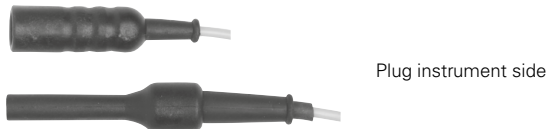
Bipolar connecting cables with two round plugs



	Length	Item number
 28,2 mm	3,0 m	<b>TWS 33516</b>
 Ø 7,8 mm	3,0 m	<b>TWS 33517</b>
 Ø 12,3 mm	3,0 m	<b>TWS 33518</b>

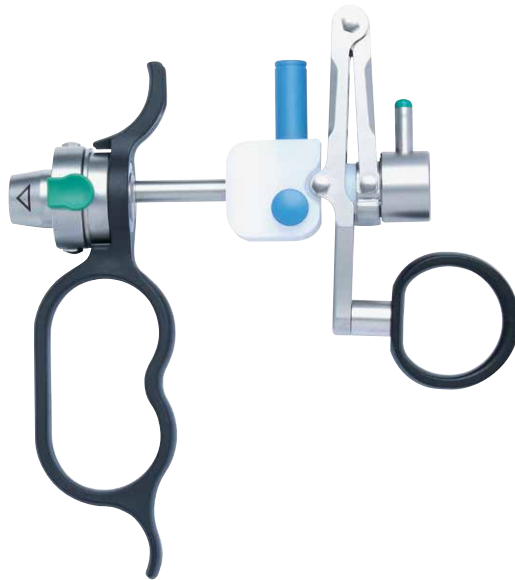

## QUICK-LOCK

**TWS 33519** 17,5 Charr. ■

for Endoscopes Ø 2.9 mm, Mini

HYBRID working element, passive cutting, single stem, closed handle

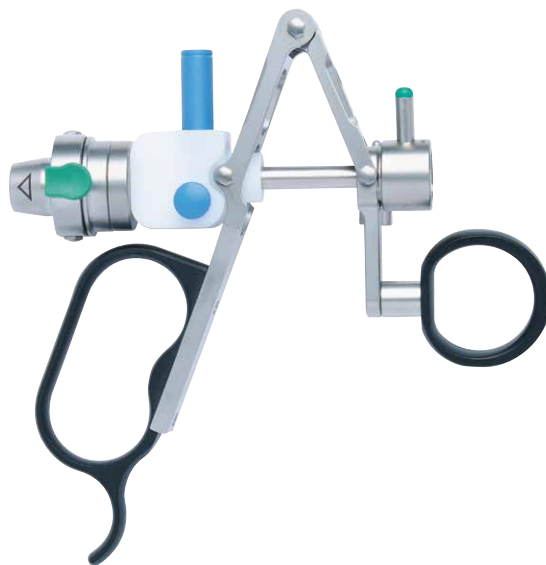

## QUICK-LOCK

**TWS 33520** 17,5 Charr. ■

for Endoscopes Ø 2.9 mm, Mini

HYBRID working element, active cutting, single stem, closed handle

HYBRID electrodes



**TWS 33521** 17,5 Charr. ■

Loop electrode, 30° angled



**TWS 33522** 17,5 Charr. ■

Loop electrode, straight



**TWS 33523** 17,5 Charr. ■

Knife electrode, 90° angled



**TWS 33524** 17,5 Charr. ■

Ball electrode, Ø 2.0 mm



**TWS 33525** 17,5 Charr. ■

Roller electrode, smooth, Ø 2.0 mm



**TWS 33526**

Sterilisation tube for resectoscopy electrodes

Resectoscopy continuous flow sheath with 2 stopcocks, **rotatable inner sheath**, surround perforation

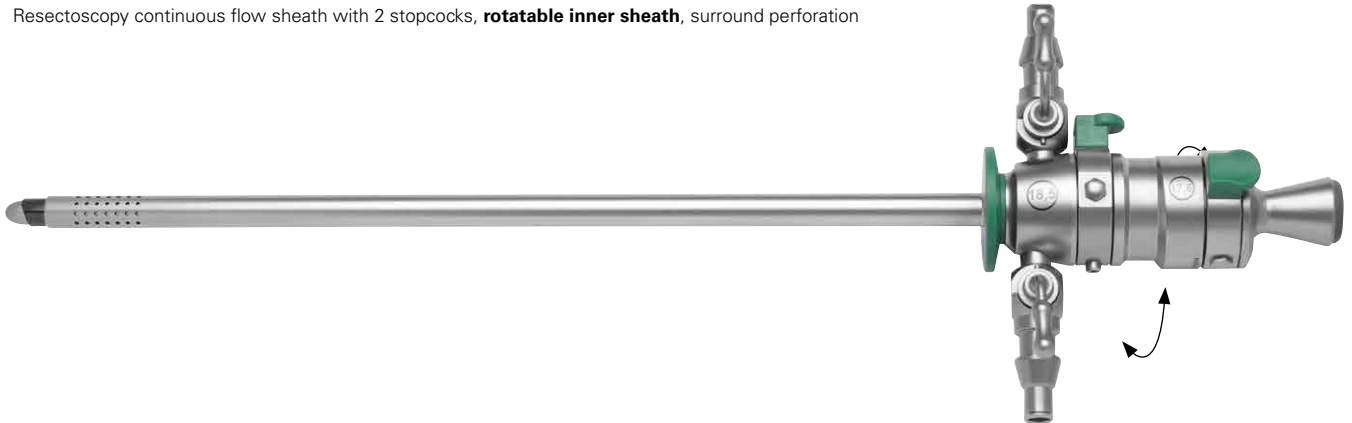

**QUICK-LOCK**

Size	Colour code	Complete with obturator	Inner sheath, only	Outer sheath, only	Obturator, only
18,5 Charr.	■	<b>TWS 33527</b>	<b>TWS 33528</b> 17,5 Charr.	<b>TWS 33529</b>	<b>TWS 33530</b>



**QUICK-LOCK**

**TWS 33531** 17,5 Charr. ■

Standard obturator for resectoscopy sheaths



**QUICK-LOCK**

**TWS 33532** 17,5 Charr. ■ Kanal I Channel = 5 Charr.

Visual obturator with instrument channel for HYBRID resectoscopy outer sheath



**TWS 33533** 24 Charr. ■

HYBRID working element, passive cutting, single stem, closed handle

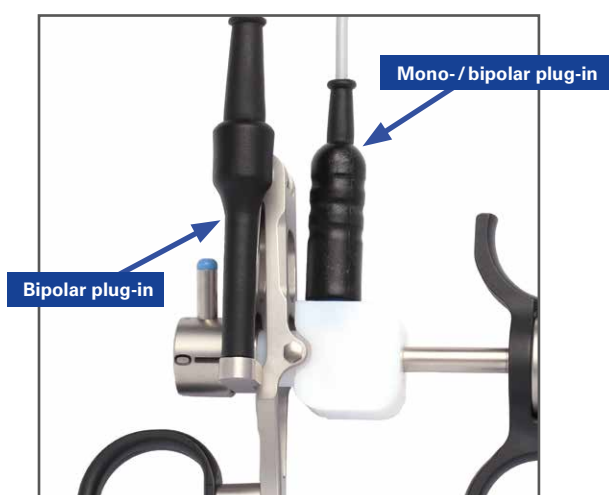

**TWS 33534** 24 Charr. ■

HYBRID working element, active cutting, single stem, closed handle

## Monopolar single stem electrodes



**TWS 33535** 24 Charr. ■

Loop electrode, 30° angled



**TWS 33536** 24 Charr. ■

Loop electrode, straight



**TWS 33537** 24 Charr. ■

Loop electrode, 90° angled,  
for 0° endoscopes



**TWS 33538** 24 Charr. ■

Knife electrode, 90° angled



**TWS 33539** 24 Charr. ■

Cone electrode



**TWS 33540** 24 Charr. ■

Ball electrode, Ø 3.0 mm



**TWS 33541** 24 Charr. ■

Ball electrode, Ø 5.0 mm



**TWS 33542** 19 Charr. ■

Roller electrode, smooth, Ø 3.0 mm



**TWS 33543** 24 Charr. ■

Roller electrode, smooth, Ø 5.0 mm



**TWS 33544** 24 Charr. ■

Vaporisation electrode, serrated, Ø 3.0 mm



**TWS 33545** 24 Charr. ■

Vaporisation electrode, serrated, Ø 5.0 mm





**TWS 33546** 24 Charr. ■

Cut-vaporisation electrode

Bipolar single stem electrodes



**TWS 33547** 24 Charr.   
**TWS 33548** 24 Charr. PI 

Loop electrode, 30° angled



**TWS 33549** 24 Charr. 

Loop electrode, straight



**TWS 33550** 24 Charr. 

Loop electrode, 90° angled,  
for 0° endoscopes



**TWS 33551** 24 Charr. 

Knife electrode, 90° angled



**TWS 33552** 24 Charr. 

Cone electrode



**TWS 33553** 24 Charr. 

Ball electrode, Ø 3.0 mm



**TWS 33554** 24 Charr. 

Roller electrode, smooth, Ø 3.0 mm



**TWS 33555** 24 Charr. 

Vaporisation electrode, serrated, Ø 3.0 mm



**TWS 33556** 24 Charr. 

Vaporisation electrode, serrated, Ø 5.0 mm



**TWS 33557**

Sterilisation tube for resectoscopy electrodes

## Resectoscopy sheaths

Resectoscopy continuous flow sheaths with 2 stopcocks, **fixed inner sheath**, surround perforation



Size	Colour code	Complete with obturator	Inner sheath, only	Outer sheath, only	Obturator, only
26 Charr.		<b>TWS 33558</b>	<b>TWS 33561</b> 24 Charr.	<b>TWS 33559</b>	<b>TWS 33560</b>

Resectoscopy continuous flow sheaths with 2 stopcocks, **rotatable inner sheath**, surround perforation

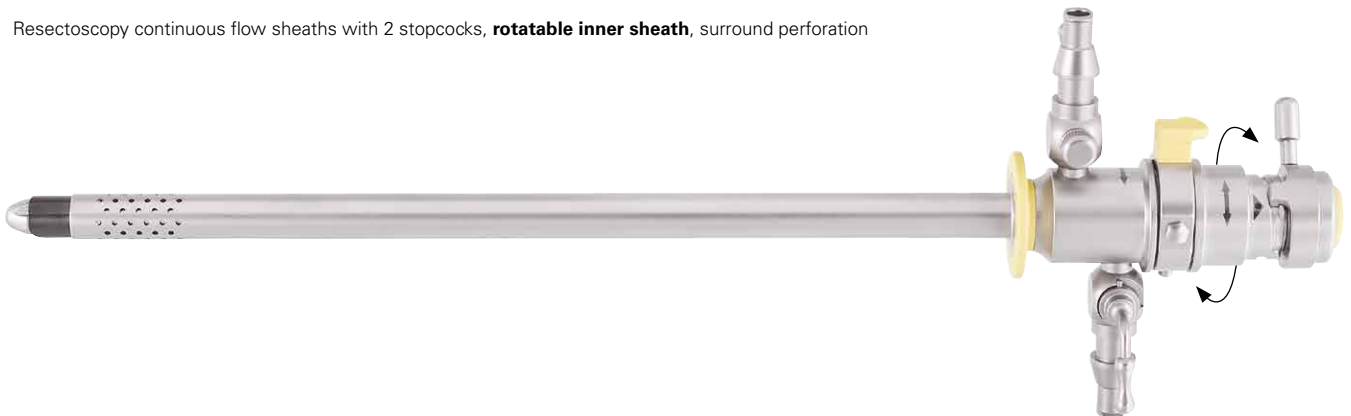

Size	Colour code	Complete with obturator	Inner sheath, only	Outer sheath, only	Obturator, only
26 Charr.		<b>TWS 33562</b>	<b>TWS 33565</b> 24 Charr	<b>TWS 33563</b>	<b>TWS 33564</b>



**TWS 33566** 24 Charr. ■

Standard obturator for resectoscopy sheaths



**TWS 33567** 24 Charr. ■

Visual obturator for resectoscopy sheaths



**TWS 33568** 24 Charr. ■ Kanal I Channel = 5 Charr.

Visual obturator with instrument channel for resectoscopy sheaths



**TWS 33569** 24 Charr. ■

Deflecting obturator for resectoscopy sheaths

## Monopolar connecting cables with round plug



Plug instrument side



	Length	Item number
 Ø 4 mm	3,0 m	<b>TWS 33570</b>
	5,0 m	<b>TWS 33571</b>
 Ø 5 mm	3,0 m	<b>TWS 33572</b>
	5,0 m	<b>TWS 33573</b>
 Ø 8 mm	3,0 m	<b>TWS 33574</b>
	5,0 m	<b>TWS 33575</b>

## Bipolar connecting cables with two round plugs



Plug instrument side



	Length	Item number
 28,2 mm	3,0 m	<b>TWS 33576</b>
 Ø 7,8 mm	3,0 m	<b>TWS 33577</b>
 Ø 12,3 mm	3,0 m	<b>TWS 33578</b>

## Uterus manipulator

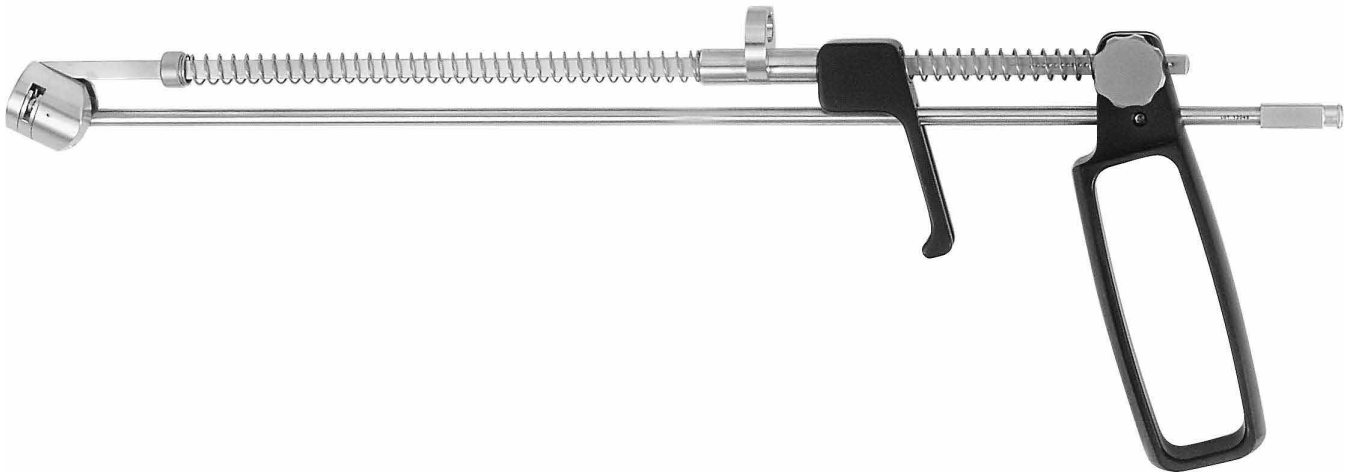

### **TWS 33579**

Uterus manipulator, only

### **TWS 33580 SET**

Uterus manipulator, complete with 6 adapters



### **TWS 33581** Ø 8 x 80 mm

Adapter



### **TWS 33582** Ø 3 x 45 mm

Adapter



### **TWS 33583**

Adapter with cone, short



### **TWS 33584** Ø 10 x 100 mm

Adapter



### **TWS 33585** Ø 3 x 55 mm

Adapter



### **TWS 33586**

Adapter with cone, long



**TWS 33587** SET

Uterus manipulator, complete



**TWS 33588**

Universal handle, rotatable



**TWS 33589**

Shaft with fixation nut



**TWS 33590**

Inner shaft with locking pin



**TWS 33591**

Sliding and fixation shaft



**TWS 33592**

Cervical tenaculum insert



**TWS 33593** Ø 4 x 40 mm

**TWS 33594** Ø 5 x 50 mm

**TWS 33595** Ø 6 x 60 mm

**TWS 33596** Ø 7 x 70 mm

**TWS 33597** Ø 8 x 80 mm

Intrauterine element with thread



**TWS 33598** 35,0 mm

**TWS 33599** 40,0 mm

**TWS 33600** 45,0 mm

Tube with insulating ring



**TWS 33602** Ø 6,1 mm

Adapter for OP-Laparoscope

**HD LAP**

Length	Ø	Angle
266,3 mm	10,0 mm	0°

OP-Laparoscope, 90° double angled, instrument channel Ø 6.0 mm, including adapter



**TWS 33605** Ø 6,1 mm

Adapter for OP-Laparoscope

**HD LAP**

Länge Length	Ø	Angle
266,3 mm	10,0 mm	0°

OP-Laparoscope, 45° angled, instrument channel Ø 6.0 mm, including adapter

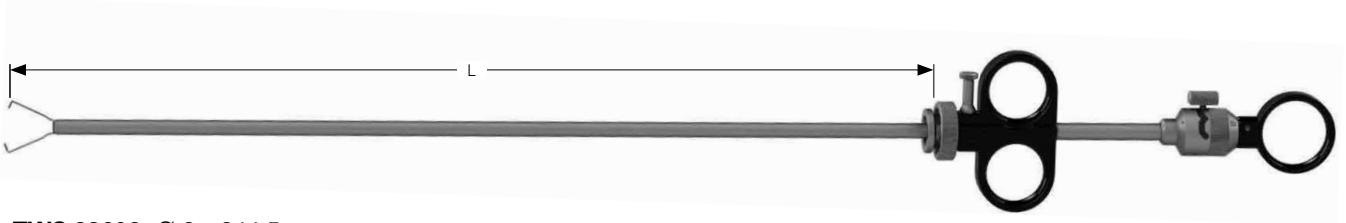

**TWS 33606** Ø 6 x 344,5 mm

Ring applicator for single puncture for use with OP-Laparoscope, complete with loading device and cone part

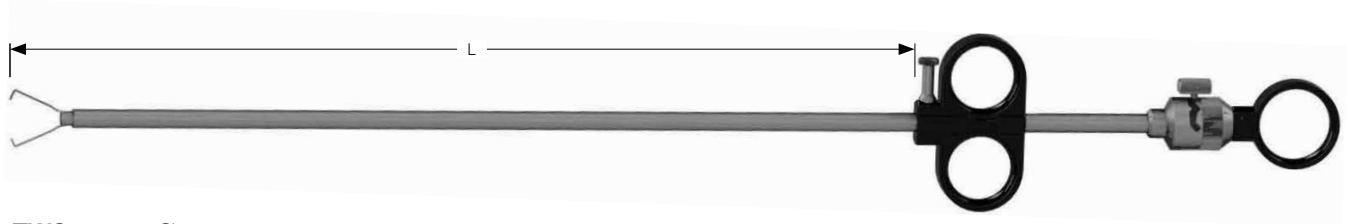

**TWS 33607** Ø 6,5 x 300 mm

Ring applicator for double puncture for use with Ø 7.0 mm trocar sleeve, complete with loading device and cone part



**TWS 33608**

Loading device for ring applicator



**TWS 33609**

Cone part for ring applicator

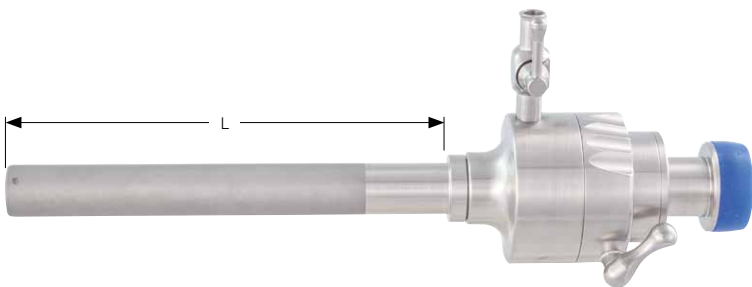

Automatic trocar sleeve with multifunctional valve



Complete with sleeve and conical trocar



Complete with sleeve and pyramidal trocar

Working length	Ø	Sleeve, only	Complete A 	Complete B 
95,0 mm	7,0 mm	<b>TWS 33610</b>	<b>TWS 33614</b>	<b>TWS 33618</b>
97,0 mm	10,0 mm	<b>TWS 33611</b>	<b>TWS 33615</b>	<b>TWS 33619</b>
101,0 mm	11,0 mm	<b>TWS 33612</b>	<b>TWS 33616</b>	<b>TWS 33620</b>
150,0 mm	11,0 mm	<b>TWS 33613 XL</b>	<b>TWS 33617 XL</b>	<b>TWS 33621 XL</b>

XL = for adipose patients



**COHEN**

**TWS 33624 SET**



**TWS 33622**

**TWS 33623**

Adapter, small

Adapter, large



Myoma drill

**TWS 33625** Ø 5 x 330 mm

**TWS 33626** Ø 5 x 420 mm



Myoma drill

**TWS 33627** Ø 10 x 330 mm

**TWS 33628** Ø 10 x 420 mm

**Treasure Wright (U.K.) Ltd.**

128-160 City Road, London, EC1V 2NX, United Kingdom  
info@twrightmedical.com



**TWS 33632**

Uterine cannula



**TWS 33629**

Occlusive nozzle, small



**TWS 33630**

Manometer



**TWS 33631**

Occlusive nozzle, medium



**TWS 33633**

Occlusive nozzle, large



**TWS 33634**

Syringe, 10 ml



**TWS 33635**

Connecting piece

Complete, in wooden case

**SCHULTZE**

**TWS 33636 SET**

Complete, without manometer, without wooden case

**SCHULTZE**

**TWS 33637 SET**

**Treasure Wright (U.K.) Ltd.**

128-160 City Road, London, EC1V 2NX, United Kingdom  
info@twrightmedical.com

# Vaginal specula

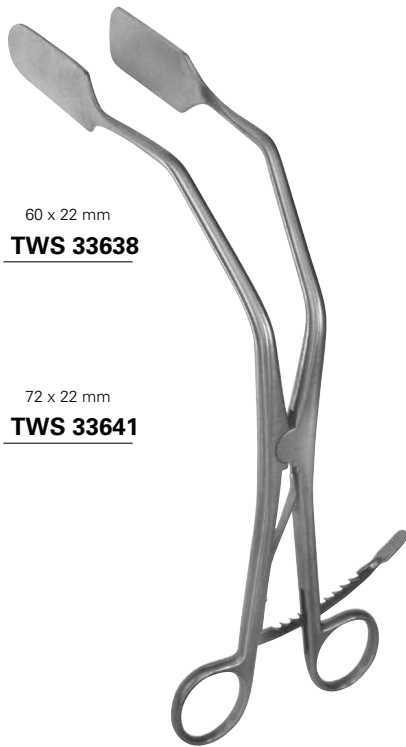

60 x 22 mm  
**TWS 33638**

72 x 22 mm  
**TWS 33641**

**TWS 33644** 25,0 cm, 9 3/4 "  
**TWS 33645** 31,0 cm, 12 1/4 "

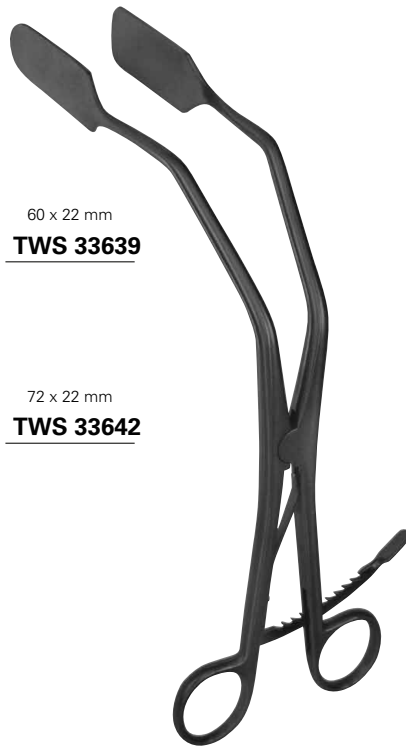

60 x 22 mm  
**TWS 33639**

72 x 22 mm  
**TWS 33642**

**TWS 33646** 25,0 cm, 9 3/4 "  
**TWS 33647** 31,0 cm, 12 1/4 "

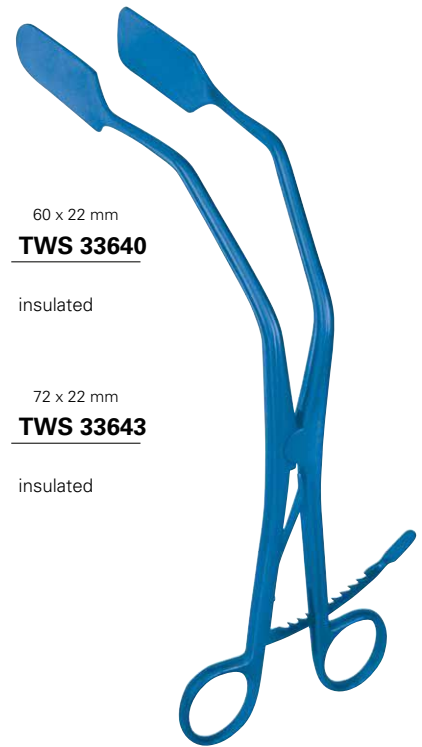

60 x 22 mm  
**TWS 33640**

72 x 22 mm  
**TWS 33643**

**TWS 33648** 25,0 cm, 9 3/4 "  
**TWS 33649** 31,0 cm, 12 1/4 "

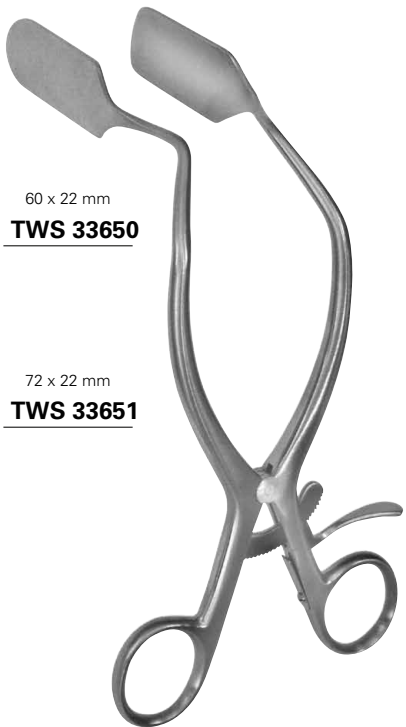

60 x 22 mm  
**TWS 33650**

72 x 22 mm  
**TWS 33651**

**TWS 33656** 25,0 cm, 9 3/4 "  
**TWS 33657** 31,0 cm, 12 1/4 "



60 x 22 mm  
**TWS 33652**

72 x 22 mm  
**TWS 33654**

**TWS 33658** 25,0 cm, 9 3/4 "  
**TWS 33659** 31,0 cm, 12 1/4 "

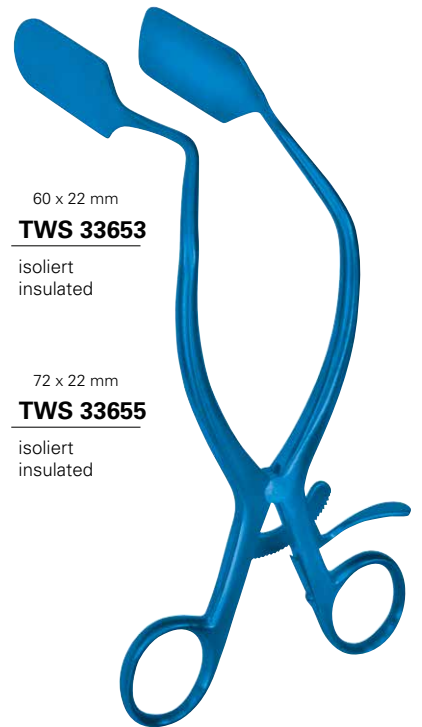

60 x 22 mm  
**TWS 33653**

72 x 22 mm  
**TWS 33655**

**TWS 33660** 25,0 cm, 9 3/4 "  
**TWS 33661** 31,0 cm, 12 1/4 "



lateral fixation screw

### CUSCO STANDARD

**TWS 33662** 80 x 24 mm

**TWS 33663** 75 x 32 mm

**TWS 33664** 85 x 35 mm

**TWS 33665** 110 x 37 mm



lateral fixation screw

### GRAVE

**TWS 33666** 75 x 20 mm

**TWS 33667** 95 x 35 mm

**TWS 33668** 115 x 35 mm



### KRISTELLER

**TWS 33669** Fig. 0

**TWS 33670** Fig. 1

**TWS 33671** Fig. 2

**TWS 33672** Fig. 3

Set

### KRISTELLER

**TWS 33673** 70 x 15 mm

**TWS 33674** 70 x 27 mm

**TWS 33675** 80 x 30 mm

**TWS 33676** 90 x 36 mm

Specula only

### KRISTELLER

**TWS 33677** 70 x 15 mm

**TWS 33678** 75 x 23 mm

**TWS 33679** 85 x 26 mm

**TWS 33680** 100 x 32 mm

Retractor only



**KOGAN**

**TWS 33685** 24,0 cm, 9 ½"



**KOGAN**

**TWS 33686** 24,0 cm, 9 ½"

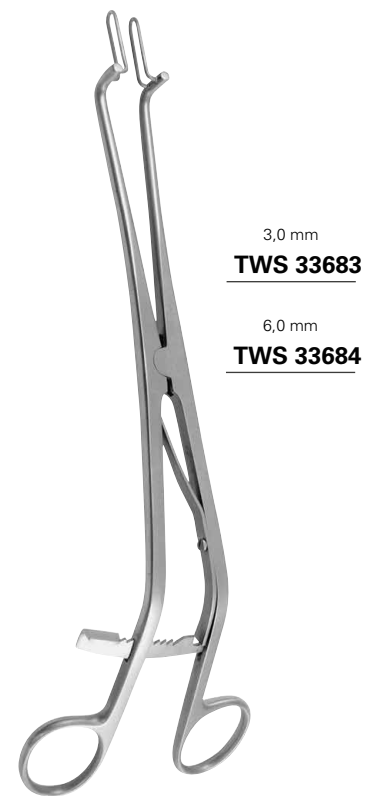

**KOGAN**

**TWS 33687 - TWS 33688** 27,0 cm, 10¾"

**HEGAR**

**TWS 33689** 4,0 - 17,0 mm



**HEGAR**

**TWS 33690** 1,0 - 26,0 mm

**HEGAR**

- TWS 33691** Ø 1,0 mm
- TWS 33692** Ø 2,0 mm
- TWS 33693** Ø 3,0 mm
- TWS 33694** Ø 4,0 mm
- TWS 33695** Ø 5,0 mm
- TWS 33696** Ø 6,0 mm
- TWS 33697** Ø 7,0 mm
- TWS 33698** Ø 8,0 mm
- TWS 33699** Ø 9,0 mm
- TWS 33700** Ø 10,0 mm
- TWS 33701** Ø 11,0 mm
- TWS 33702** Ø 12,0 mm
- TWS 33703** Ø 13,0 mm
- TWS 33704** Ø 14,0 mm
- TWS 33705** Ø 15,0 mm

**HEGAR**

- TWS 33706** Ø 16,0 mm
- TWS 33707** Ø 17,0 mm
- TWS 33708** Ø 18,0 mm
- TWS 33709** Ø 19,0 mm
- TWS 33800** Ø 20,0 mm
- TWS 33801** Ø 21,0 mm
- TWS 33802** Ø 22,0 mm
- TWS 33803** Ø 23,0 mm
- TWS 33804** Ø 24,0 mm
- TWS 33805** Ø 25,0 mm
- TWS 33806** Ø 26,0 mm
- TWS 33807** Ø 27,0 mm
- TWS 33808** Ø 28,0 mm
- TWS 33809** Ø 29,0 mm
- TWS 33810** Ø 30,0 mm

**HEGAR**

- TWS 33811** Ø 1,5 mm
- TWS 33812** Ø 2,5 mm
- TWS 33813** Ø 3,5 mm
- TWS 33814** Ø 4,5 mm
- TWS 33815** Ø 5,5 mm
- TWS 33816** Ø 6,5 mm
- TWS 33817** Ø 7,5 mm
- TWS 33818** Ø 8,5 mm
- TWS 33819** Ø 9,5 mm
- TWS 33820** Ø 10,5 mm
- TWS 33821** Ø 11,5 mm
- TWS 33822** Ø 12,5 mm
- TWS 33823** Ø 13,5 mm
- TWS 33824** Ø 14,5 mm
- TWS 33825** Ø 15,5 mm
- TWS 33826** Ø 16,5 mm
- TWS 33827** Ø 17,5 mm
- TWS 33828** Ø 18,5 mm
- TWS 33829** Ø 19,5 mm



**HEGAR**

**TWS 33830** 4,0 - 17,0 mm

**HEGAR**

**TWS 33831** 1,0 - 26,0 mm

**TWS 33834** 4,0 - 17,0 mm

**TWS 33835** 1,0 - 26,0 mm

**TWS 33836** 4,0 - 17,0 mm

**TWS 33837** 1,0 - 26,0 mm

**TWS 33838** 4,0 - 12,0 mm

**TWS 33839** 13,0 - 17,0 mm

**TWS 33840** 1,0 - 17,0 mm

**TWS 33841** 18,0 - 26,0 mm

Rack, only

Rack, only

**HEGAR**

**TWS 33842** 3/4 - 17/18 mm

**HEGAR**

**TWS 33843** 1/2 - 25/26 mm



**HEGAR**

- TWS 33844** Ø 1 - 2 mm
- TWS 33845** Ø 3 - 4 mm
- TWS 33846** Ø 5 - 6 mm
- TWS 33847** Ø 7 - 8 mm
- TWS 33848** Ø 9 - 10 mm
- TWS 33849** Ø 11 - 12 mm
- TWS 33850** Ø 13 - 14 mm
- TWS 33851** Ø 15 - 16 mm
- TWS 33852** Ø 17 - 18 mm
- TWS 33853** Ø 19 - 20 mm
- TWS 33854** Ø 21 - 22 mm
- TWS 33855** Ø 23 - 24 mm
- TWS 33856** Ø 25 - 26 mm



**HEGAR**

**TWS 33857** 3/4 - 17/18 mm



**HEGAR**

**TWS 33858** 1/2 - 25/26 mm



**TWS 33859**

rigid

**TWS 33860**

malleable



**TWS 33861**

rigid

**TWS 33862**

malleable



**SIMS**

**TWS 33863 - TWS 33864** 32,0 cm, 12 ½"

**MARTIN**

**TWS 33865 - TWS 33866** 32,0 cm, 12 ½"

**VALLEIX**

**TWS 33867** 29,5 cm, 11 ½"



Uterine depressor

**BRAUN**

**TWS 33869** 28,0 cm, 11 "



Uterine depressor

**SIMS**

**TWS 33870** 26,0 cm, 10 ¼ "



Uterine curette

**BLAKE**

**TWS 33871** 28,0 cm, 11 "

blunt



13,0 mm

**TWS 33868**

8,0 mm



sharp



**SCHROEDER**

**TWS 33873** 25,0 cm, 9  $\frac{3}{4}$  "



**BRAUN**

**TWS 33874** 25,0 cm, 9  $\frac{3}{4}$  "



**POZZI**

**TWS 33875** 25,5 cm, 10 "

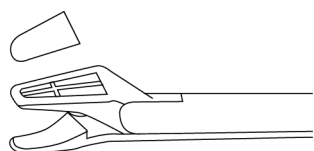
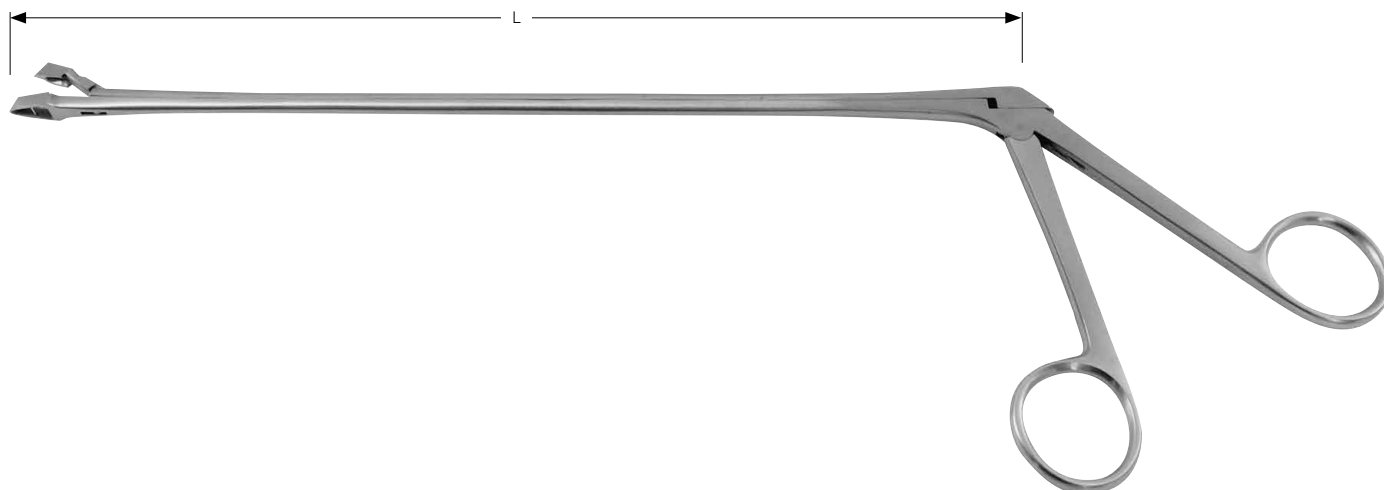

**ALEXANDER**

**TWS 33876** 20,0 cm, 8"

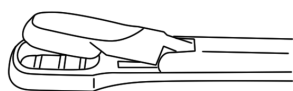

**DOUAY**

**TWS 33877** 20,0 cm, 8"  
**TWS 33878** 25,0 cm, 9 3/4"  
**TWS 33879** 30,0 cm, 11 3/4"  
**TWS 33880** 35,0 cm, 13 3/4"  
**TWS 33881** 40,0 cm, 16"

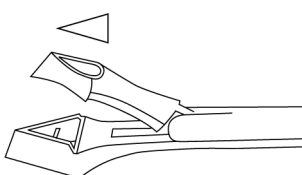

**SCHUMACHER**

**TWS 33882** 24,0 cm, 9 1/4"

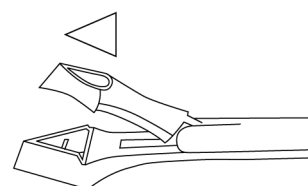

**SCHUMACHER**

**TWS 33883** 24,0 cm, 9 1/4"

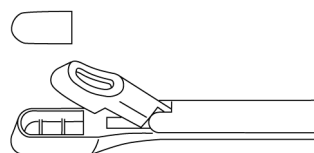

**EPPENDORF**

**TWS 33884** 20,0 cm, 8"  
**TWS 33885** 23,0 cm, 9"

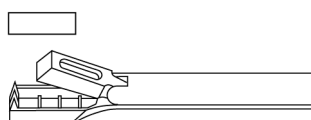

**KEVORKIAN**

**TWS 33886** 20,0 cm, 8"  
**TWS 33887** 23,0 cm, 9"  
**TWS 33888** 25,0 cm, 9 3/4"

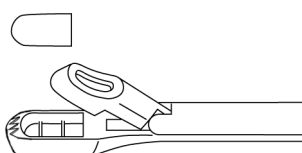

**WITTNER**

**TWS 33889** 23,0 cm, 9"

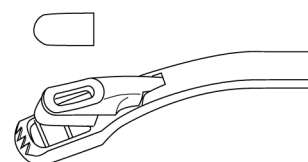

**WITTNER**

**TWS 33890** 23,0 cm, 9"

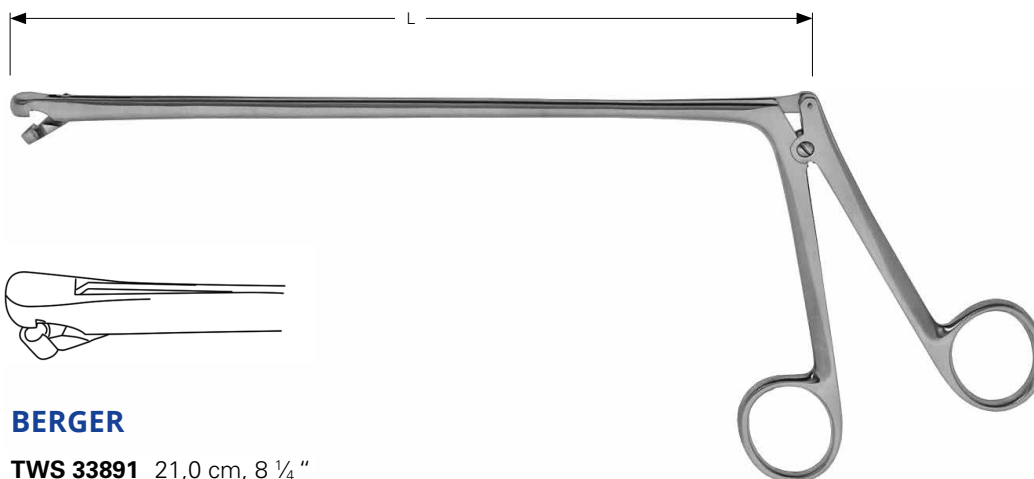

**BERGER**

**TWS 33891** 21,0 cm, 8 1/4"

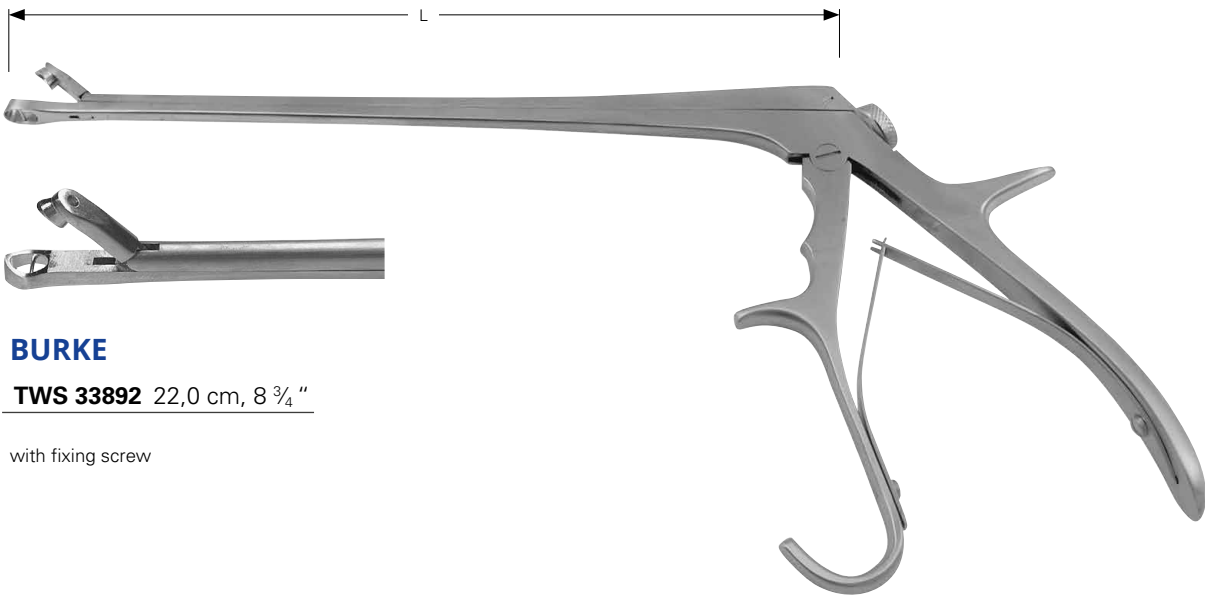

**BURKE**

**TWS 33892** 22,0 cm, 8 3/4"

with fixing screw

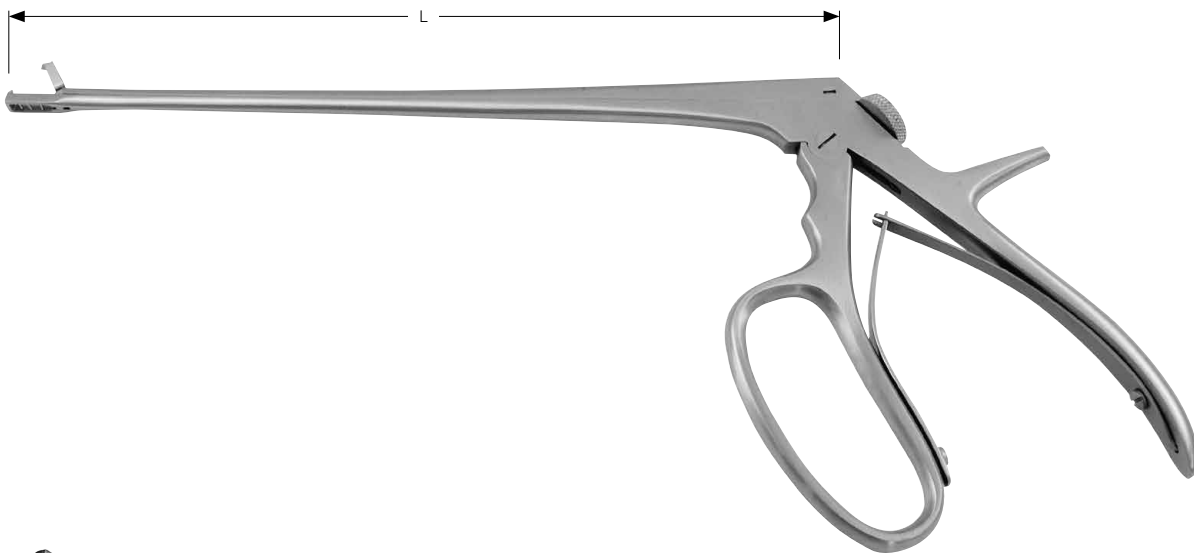

**TISCHLER-KEVORKIAN**

**TWS 33893** 22,0 cm, 8 3/4"

with fixing screw



**KEVORKIAN-PACIFIC**

**TWS 33894** 22,0 cm, 8 3/4"

with fixing screw



**TISCHLER**

**TWS 33895** 23,0 cm, 9"

with fixing screw



**BABY-TISCHLER**

**TWS 33896** 20,0 cm, 8"

with fixing screw



**BABY-TISCHLER**

**TWS 33897** 20,0 cm, 8"

without fixing screw



**TISCHLER-MORGAN**

**TWS 33898** 22,0 cm, 8 3/4"

without fixing screw

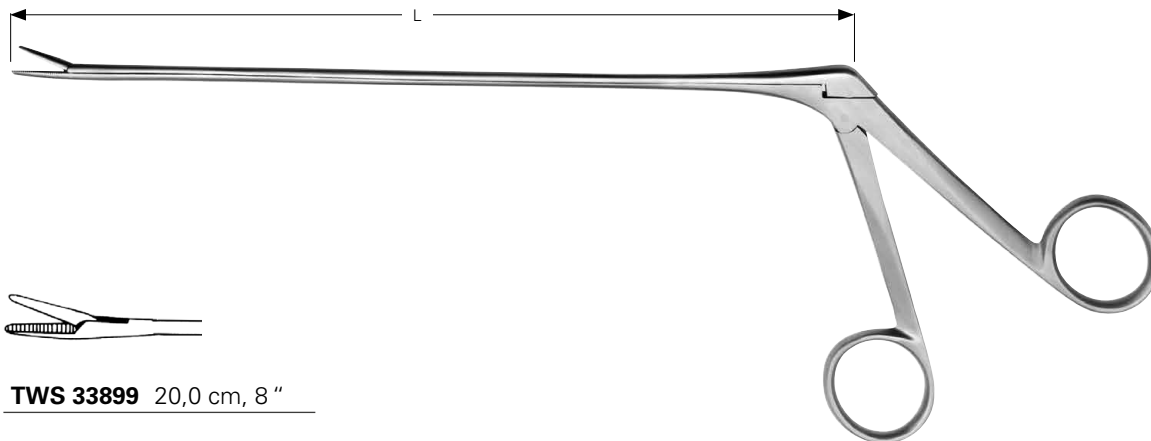

**TWS 33899** 20,0 cm, 8 "

Instrument for removal of I.U.D.



- TWS 33900** 6 Charr.
- TWS 33901** 7 Charr.
- TWS 33902** 8 Charr.
- TWS 33903** 9 Charr.
- TWS 33904** 10 Charr.
- TWS 33905** 11 Charr.
- TWS 33906** 12 Charr.
- TWS 33907** 13 Charr.
- TWS 33908** 14 Charr.
- TWS 33909** 16 Charr.
- TWS 33910** 18 Charr.
- TWS 33911** 20 Charr.
- TWS 33912** 22 Charr.
- TWS 33913** 24 Charr.

for women

**TWS 33914 - TWS 33915** 15,0 cm, 6 "



**TWS 33916 SET**

complete, 1 m pressure tube

**TWS 33917**

Water jet pistol, only

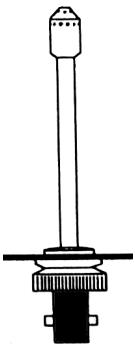

**TWS 33918**

for bottles



**TWS 33919**

for Record syringes



**TWS 33920**

for catheters



**TWS 33921**

for drainage tubes



**TWS 33922**

for receptacles



**TWS 33923**

for needles with Record-cone



**TWS 33924**

for needles with Luer

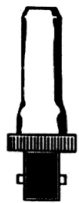

**TWS 33925**

for pipettes

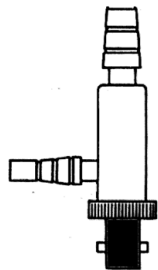

**TWS 33926**

for fine pipettes

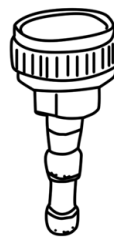

**TWS 33927**

Coupling 1/2 "

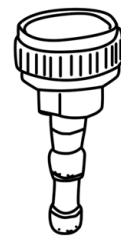

**TWS 33928**

Coupling 3/4 "

## Endoscopy baskets, Scope containers

Endoscopy basket with silicone holders for endoscopes



1 Endoscope  
2 Endoscopes

Dimensions  
290 x 80 x 55

**TWS 33929**  
**TWS 33932**

Dimensions  
460 x 80 x 55

**TWS 33930**  
**TWS 33933**

Dimensions  
670 x 80 x 55

**TWS 33931**

Endoscopy basket with silicone holders for a variable no. of endoscopes



Dimensions  
290 x 160 x 52

**TWS 33934**

Dimensions  
310 x 150 x 77

**TWS 33935**

Dimensions  
460 x 160 x 52

**TWS 33936**

Dimensions  
460 x 225 x 52

**TWS 33937**

Sterilization basket for a variable no. of endoscopes / URS with adjustable holding device

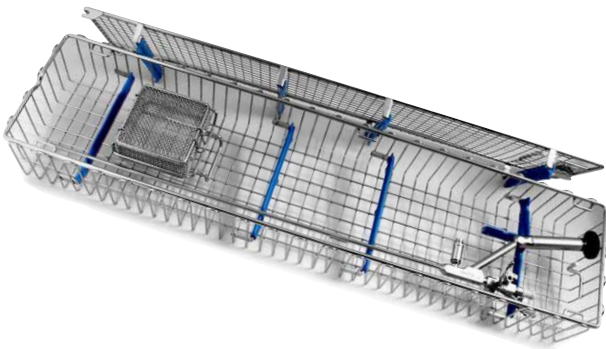

Dimensions  
580 x 160 x 52

**TWS 33938**

Dimensions  
640 x 150 x 77

**TWS 33939**

Alu scope container, without filters, only for transport and storage, with endoscope holding devices



Dimensions  
254 x 61,5 x 49,5

**TWS 33940**

Dimensions  
454 x 72 x 62,5

**TWS 33941**

Dimensions  
454 x 72 x 62,5

**TWS 33942**

for Endoscope  $\varnothing$  2,7 / 4,0 mm     $\varnothing$  4,0 / 5,0 mm     $\varnothing$  10,0 mm

**Treasure Wright (U.K.) Ltd.**

! All dimensions in millimetres (mm)

Sterilising box made of heavy stable plastic with PTFE filter. Autoclavable up to 134° C. Proofed for plasma (STERRAD®) and gas sterilisation.

# XL

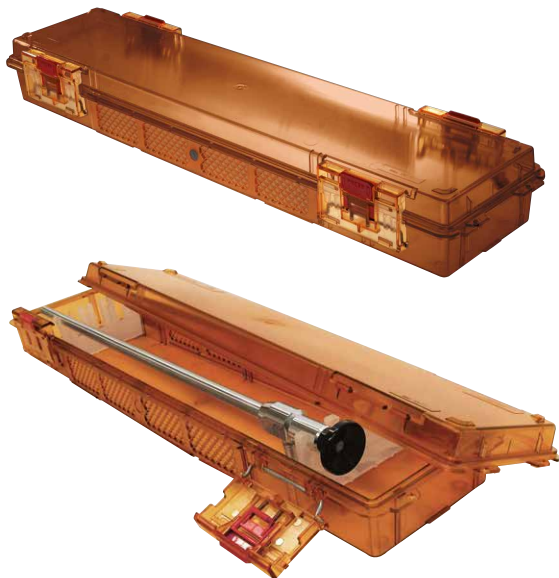

	Dimensions	Dimensions
Plastic colour	497 x 122 x 65	497 x 122 x 65
	<b>TWS 33943</b>	<b>TWS 33944</b>
Yearly filter		Permanent filter

! Steribox without endoscope holding devices

### TWS 33945

Endoscope holding device, 3 x 15 mm / 3 x 2 mm, Unit 2 pcs.

### TWS 33946

Endoscope holding device, 3 x 15 mm / 3 x 10 mm, Unit 2 pcs.

PTFE Filter sets



Size	Yearly filter	Permanent filter
XL	<b>TWS 33947</b>	<b>TWS 33948</b>

Indicator label



Size	Item number
SHIMILIXL	<b>TWS 33949</b>

Plastic seal



Size	Item number
SHIMILIXL	<b>TWS 33950</b>

All dimensions in millimetres (mm)

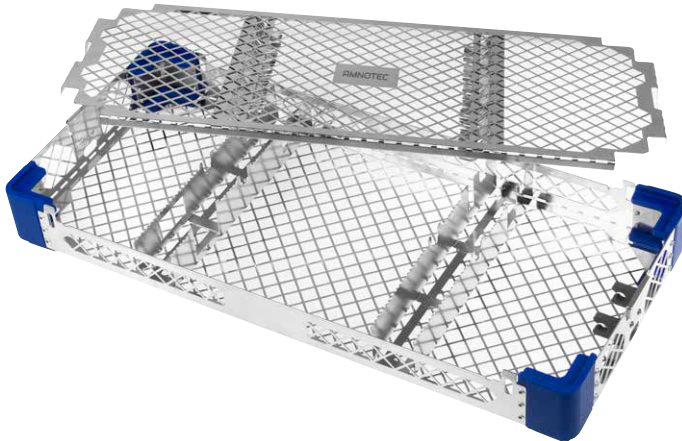

**TWS 33951** 540 x 243 x 66 mm

**TWS 33952** 540 x 243 x 66 mm

Basket, complete with racks and lid

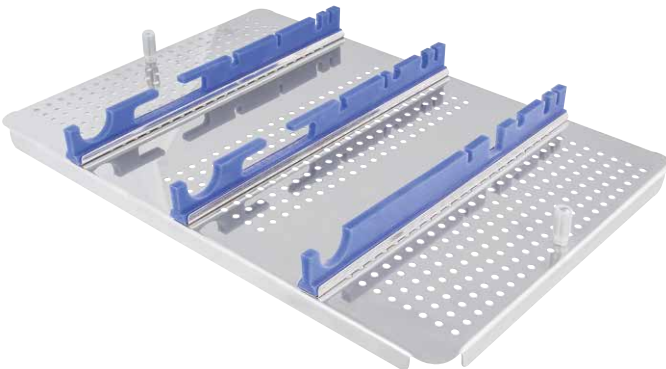

**TWS 33953**

Insert for Resectoscopy Set



**TWS 33954**

Protection tube for endoscopes up to  $\varnothing$  5.0 mm and WL 188 mm



**TWS 33955**

Protection tube for endoscopes up to  $\varnothing$  5.0 mm and WL 302 mm



**TW**  
Surgical

## Treasure Wright (U.K.) Ltd.

---

**Address: 128-160 , City Road,  
London EC1V 2NX. United Kingdom**

---

[www.twrightmedical.com](http://www.twrightmedical.com)

[info@twrightmedical.com](mailto:info@twrightmedical.com)



TW Surgical



**UK  
CA CE**