



**TW**  
Surgical

# GENERAL INSTRUMENT



**UK  
CA CE**



TW Surgical

Treasure Wright (U.K.) Ltd.



[www.twrightmedical.com](http://www.twrightmedical.com)



[info@twrightmedical.com](mailto:info@twrightmedical.com)



TW Surgical

## SUPER-CUT SCISSORS

### SUPER-CUT SCISSORS

Super-Cut Scissors represent a truly remarkable advance in scissors technology. Using the finest surgical steel, the latest heat treating methods and master craftsmanship, the upper blade of the scissors is ground to a razor-sharp edge. This process creates scissors with an unprecedented smooth and effective cutting action.

#### Benefits of Super-Cut Scissors:

- Cut through soft and fibrous tissue without effort.
- Superb control permits precision in dissection.
- Less hand fatigue for the surgeon and less trauma for the patient.
- Retain sharpness longer than ordinary scissors.
- Ring handles are black-coated for easy identification.
- Fully autoclavable.

Surgeons who use our Super-Cut Scissors are convinced of their superior performance and won't do without them on their surgical trays.

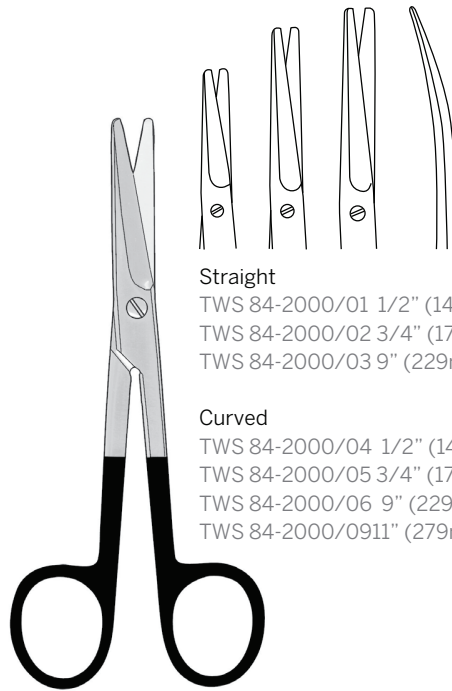

#### Straight

TWS 84-2000/01 1/2" (140mm)  
 TWS 84-2000/02 3/4" (171mm)  
 TWS 84-2000/03 9" (229mm)

#### Curved

TWS 84-2000/04 1/2" (140mm)  
 TWS 84-2000/05 3/4" (171mm)  
 TWS 84-2000/06 9" (229mm)  
 TWS 84-2000/09 11" (279mm)

### SUPER-CUT MAYO SCISSORS

Beveled blades, blunt points

Flat, blunt scissors for dissecting soft tissue.



#### Straight

TWS 84-2000/08  
 4 1/2" (114mm) blunt points

#### Curved

TWS 84-2000/09  
 4 1/2" (114mm) blunt points

### SUPER-CUT BABY METZENBAUM SCISSORS

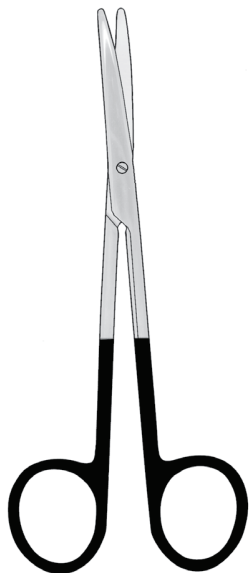

### SUPER-CUT METZENBAUM SCISSORS

Blunt point

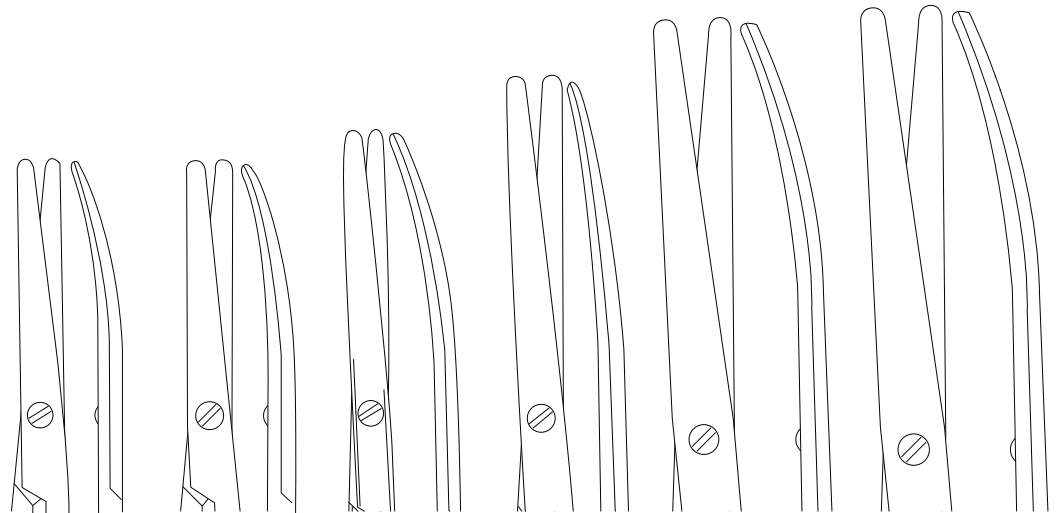

#### Straight

TWS 84-2000/16 6" (152mm)  
 TWS 84-2000/17 7" (171mm)

#### Curved

TWS 84-2000/18 6" (152mm)  
 TWS 84-2000/19 7" (178mm)  
 TWS 84-2000/20 7" (178mm)  
 TWS 84-2000/22 8" (203mm)  
 TWS 84-2000/21 9" (229mm)  
 TWS 84-2000/23 11" (279mm)

delicate

Treasure Wright (U.K.) Ltd.

128-160 City Road, London, EC1V 2NX, United Kingdom  
info@twrightmedical.com



TW Surgical

# SUPER-CUT SCISSORS

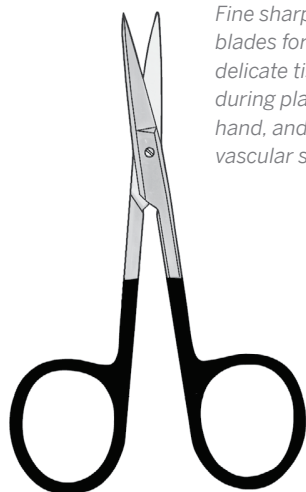

*Fine sharp/sharp blades for cutting delicate tissue during plastic, hand, and minor vascular surgery.*

## SUPER-CUT IRIS SCISSORS

Sharp points

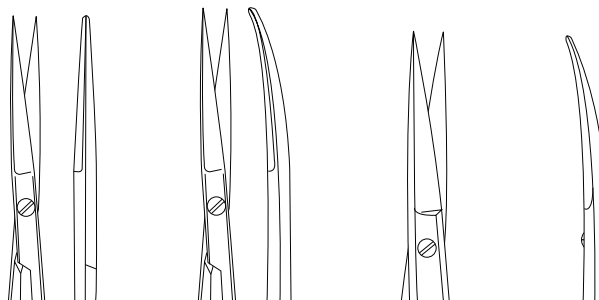

### Straight

TWS 84-2000/28 1/2" (89mm) delicate  
TWS 84-2000/29 1/2" (114mm)

### Curved

TWS 84-2000/30 1/2" (89mm) delicate  
TWS 84-2000/31 1/2" (114mm)

*Delicate short narrow tips for dissecting fine tissue.*



## SUPER-CUT STEVENS SCISSORS

Blunt points

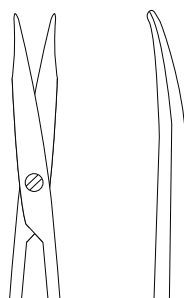

### Straight

TWS 84-2000/32  
1/2" (114mm)

### Curved

TWS 84-2000/33  
4 1/2" (114mm)  
TWS 84-2000/34  
1/4" (133mm)

*Very delicate blunt scissors with long handles for fine tissue dissection.*

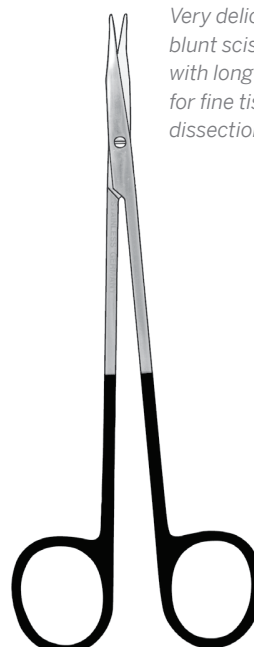

## SUPER-CUT JAMISON SCISSORS

6 1/4" (159mm)



TWS 84-2000/35  
curved  
blunt points very delicate



TW Surgical

## SUPER-CUT SCISSORS

*The delicate offset shanks and the sharp Super-Cut edge provide better leverage. The fine knob slides easily under finger and toe bandages.*

*Cuts bandages and multiple layers of dressing with ease. Razor-sharp blades reduce hand fatigue.*

- Very little strength is required for cutting, putting less strain on thumb and forearm.
- Perfect cutting control because you don't have to force them to cut.
- Retain their sharpness longer than ordinary scissors.

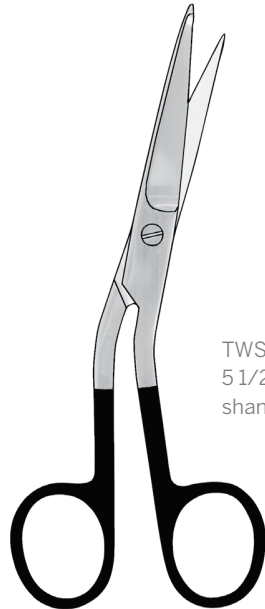

TWS 84-2000/36  
5 1/2" (140mm)  
shanks angled on side

### SUPER-CUT HI-LEVEL BANDAGE SCISSORS

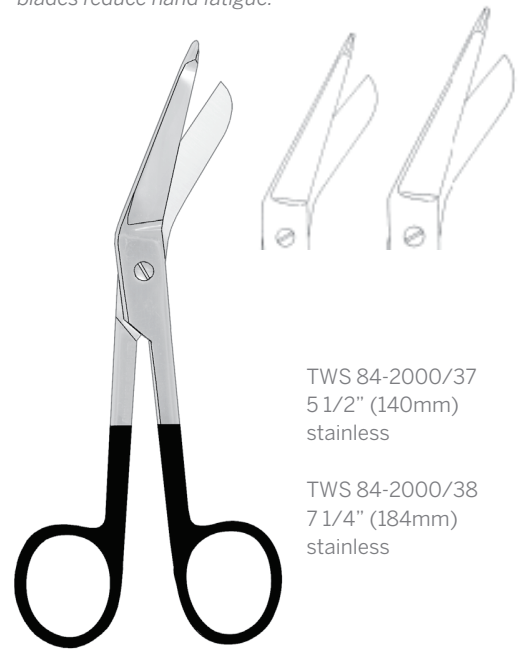

TWS 84-2000/37  
5 1/2" (140mm)  
stainless

TWS 84-2000/38  
7 1/4" (184mm)  
stainless

### SUPER-CUT LISTER BANDAGE SCISSORS

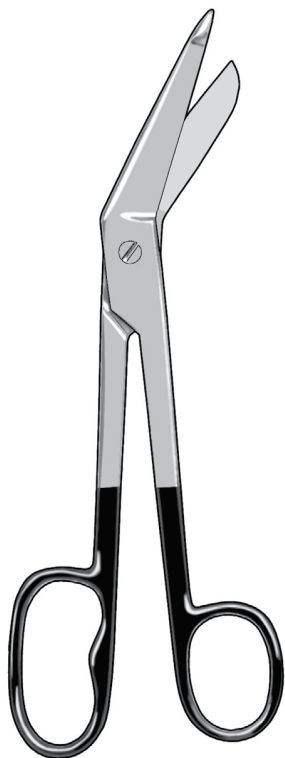

*All the benefits of our Super-Cut Lister Scissors plus an oversized finger ring, which helps relieve pressure on the third metacarpal.*



TWS 84-2100/36  
8" (203 mm)  
stainless

### SUPER-CUT LISTER BANDAGE SCISSORS WITH LARGE FINGER RING

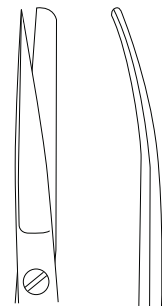
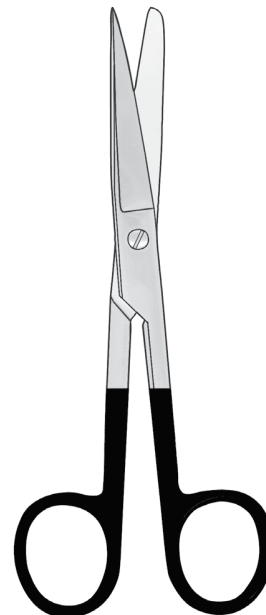

**Straight**  
TWS 84-2000/41  
5 1/2" (140mm)  
sharp/blunt

**Curved**  
TWS 84-2000/42  
5 1/2" (140mm)  
sharp/blunt

### SUPER-CUT OPERATING SCISSORS

Treasure Wright (U.K.) Ltd.

128-160 City Road, London, EC1V 2NX, United Kingdom  
info@twrightmedical.com



TW Surgical

# OPERATING AND DISSECTING SCISSORS

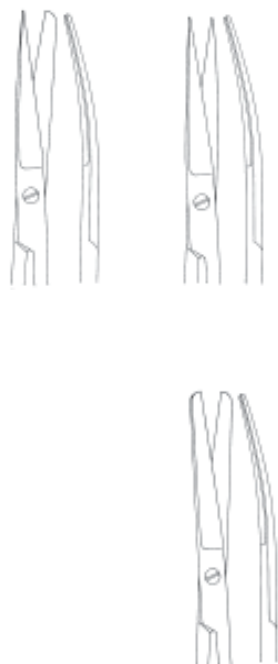
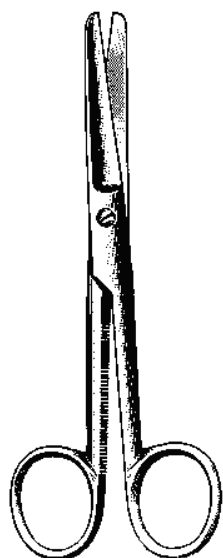

### Straight

- TWS 84-2000/43 (114mm) sharp/ blunt
- TWS 84-2000/44 (114mm) sharp/sharp
- TWS 84-2000/45 (114mm) blunt/blunt
- TWS 84-2000/46 (127mm) sharp/blunt
- TWS 84-2000/47 (127mm) sharp/sharp
- TWS 84-2000/48 (127mm) blunt/blunt
- TWS 84-2000/49 (140mm) sharp/blunt
- TWS 84-2000/50 (140mm) sharp/sharp
- TWS 84-2000/52 (140mm) blunt/blunt
- TWS 84-2000/53 (165mm) sharp/blunt
- TWS 84-2000/54 (165mm) sharp/sharp
- TWS 84-2000/55 (165mm) blunt/blunt

### Curved

- TWS 84-2000/56 (114mm) sharp/ blunt
- TWS 84-2000/57 (114mm) sharp/sharp
- TWS 84-2000/58 (114mm) blunt/blunt
- TWS 84-2000/59 (127mm) sharp/blunt
- TWS 84-2000/60 (127mm) sharp/sharp
- TWS 84-2000/61 (127mm) blunt/blunt
- TWS 84-2000/62 (140mm) sharp/blunt
- TWS 84-2000/63 (140mm) sharp/sharp
- TWS 84-2000/64 (140mm) blunt/blunt
- TWS 84-2000/65 (165mm) sharp/blunt
- TWS 84-2000/66 (165mm) sharp/sharp
- TWS 84-2000/67 (165mm) blunt/blunt

## OPERATING SCISSORS

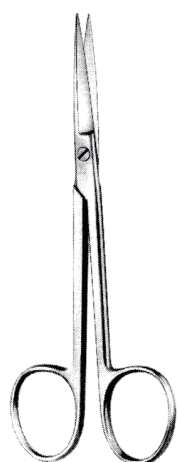

### Straight

- TWS 84-2000/74 sharp/sharp
- TWS 84-2000/75 sharp/blunt
- TWS 84-2000/76 blunt/blunt

### Curved

- TWS 84-2000/77 sharp/sharp
- TWS 84-2000/78 sharp/blunt
- TWS 84-2000/79 blunt/blunt

### Angled on side

- TWS 84-2000/80 sharp/sharp

## PLASTIC SURGERY SCISSORS

4 3/4" (121mm)

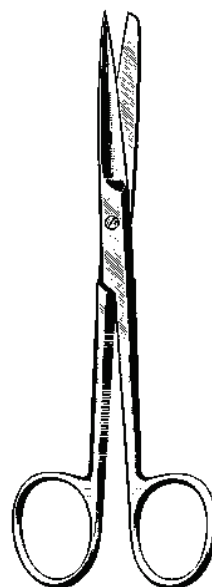

### Straight

- TWS 84-2000/81 sharp/blunt
- TWS 84-2000/82 sharp/sharp

### Curved

- TWS 84-2000/83 sharp/blunt
- TWS 84-2000/84 sharp/sharp

## DEAVER SCISSORS

5 1/2" (140mm)



TW Surgical

## OPERATING AND DISSECTING SCISSORS



### Straight

TWS 84-2000/85 6" (152mm)

TWS 84-2000/86 7" (179mm)

### Curved

TWS 84-2000/87 6" (152mm)

TWS 84-2000/88 7" (179mm)

## REYNOLDS SCISSORS

blunt points

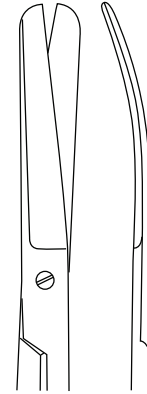
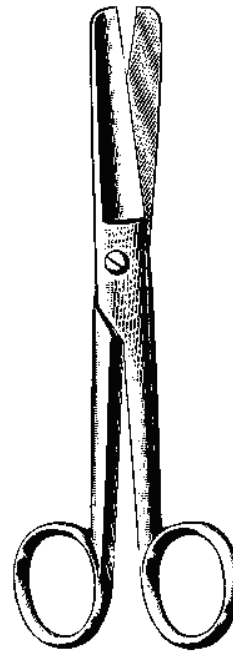

### Straight

TWS 84-2000/89

### Curved

TWS 84-2000/90

## DOYEN ABDOMINAL SCISSORS

7" (178mm)

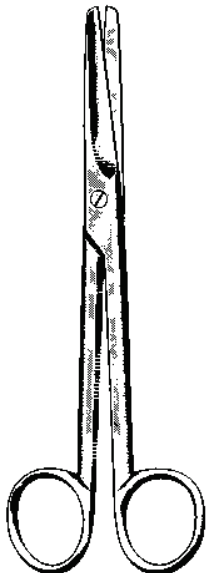

### Straight

TWS 84-2000/94 (140mm)

TWS 84-2000/95 (171mm)

TWS 84-2000/96 (229mm)

### Curved

TWS 84-2000/97 (140mm)

TWS 84-2000/98 (171mm)

TWS 84-2000/99 (229mm)

### Serrated

TWS 84-2001/03 (171mm)

TWS 84-2001/04 (171mm)

## MAYO SCISSORS

Beveled blades

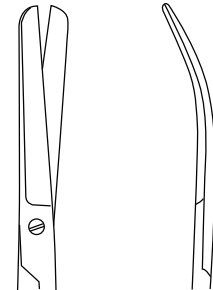
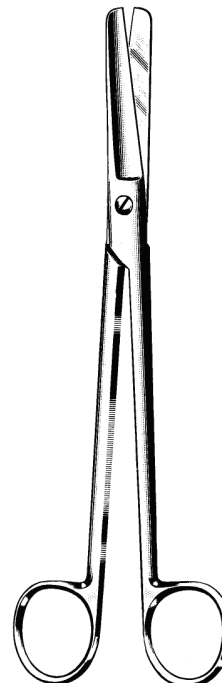

### Straight

TWS 84-2001/00 sharp/sharp

TWS 84-2001/01 sharp/blunt

TWS 84-2001/02 blunt/blunt

### Curved

TWS 84-2001/05 sharp/sharp

TWS 84-2001/06 sharp/blunt

TWS 84-2001/07 blunt/blunt

## SIMS SCISSORS

8" (203mm)

Treasure Wright (U.K.) Ltd.

128-160 City Road, London, EC1V 2NX, United Kingdom  
info@twrightmedical.com



TW Surgical

# OPERATING AND DISSECTING SCISSORS

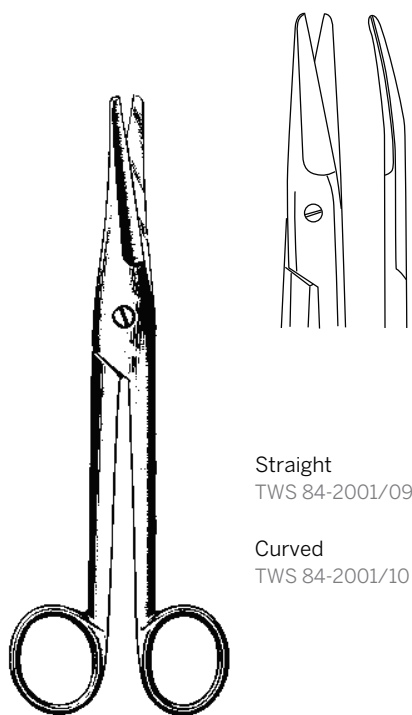

Straight  
TWS 84-2001/09

Curved  
TWS 84-2001/10

## MAYO-NOBLE SCISSORS

6 1/2" (165mm) Beveled blades

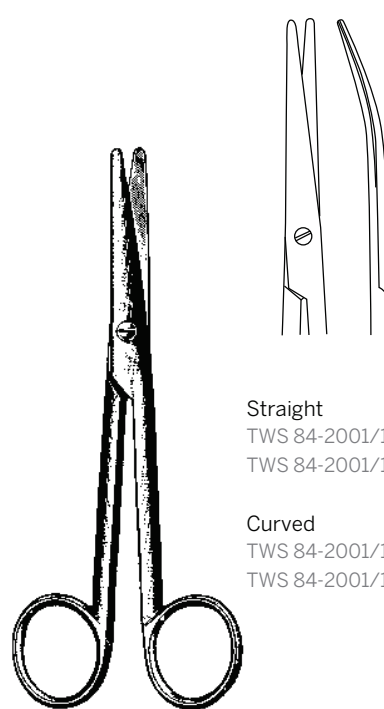

Straight  
TWS 84-2001/12 (140mm)  
TWS 84-2001/13 (171mm)

Curved  
TWS 84-2001/14 (140mm)  
TWS 84-2001/15 (171mm)

## MAYO-STILLE SCISSORS

Rounded blades



TWS 84-2001/16

## FERGUSON SCISSORS

7" (178mm)  
Angled on flat



Straight  
TWS 84-2001/18

Curved  
TWS 84-2001/19

## SISTRUNK SCISSORS

5" (127mm) Delicate

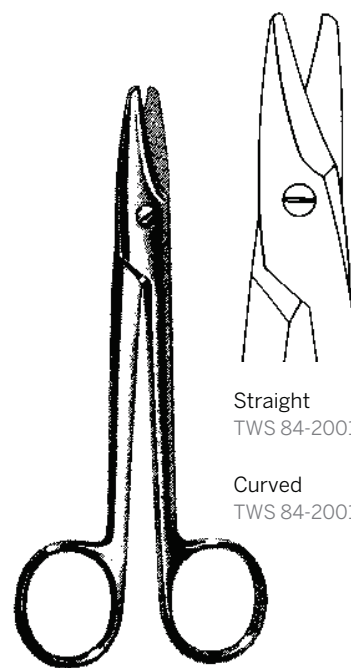

Straight  
TWS 84-2001/20

Curved  
TWS 84-2001/21

## SISTRUNK SCISSORS

5 1/2" (140mm) Heavy pattern

Treasure Wright (U.K.) Ltd.

128-160 City Road, London, EC1V 2NX, United Kingdom  
info@twrightmedical.com



TW Surgical

# OPERATING AND DISSECTING SCISSORS

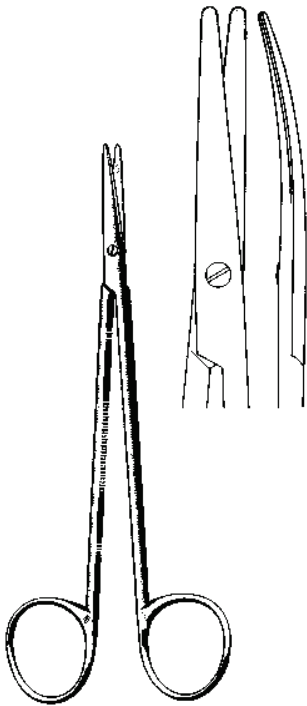

**METZENBAUM SCISSORS**  
blunt points

**Straight**

- TWS 84-2001/22 (114mm)
- TWS 84-2001/23 (152mm)
- TWS 84-2001/24 (178mm)
- TWS 84-2001/25 (203mm)
- TWS 84-2001/26 (229mm)
- TWS 84-2001/27 (279mm)

**Curved**

- TWS 84-2001/30 (114mm)
- TWS 84-2001/32 (146mm) delicate
- TWS 84-2001/31 (152mm)
- TWS 84-2001/33 (178mm)
- TWS 84-2001/34 (178mm) delicate
- TWS 84-2001/35 (203mm)
- TWS 84-2001/36 (229mm)
- TWS 84-2001/37 (279mm)

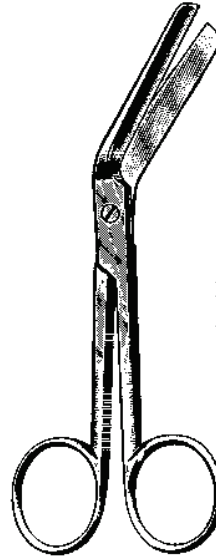

**Angled sideways**

- TWS 84-2001/28 (140mm)
- TWS 84-2001/29 (216mm)

**BRAUN EPISIOTOMY SCISSORS**

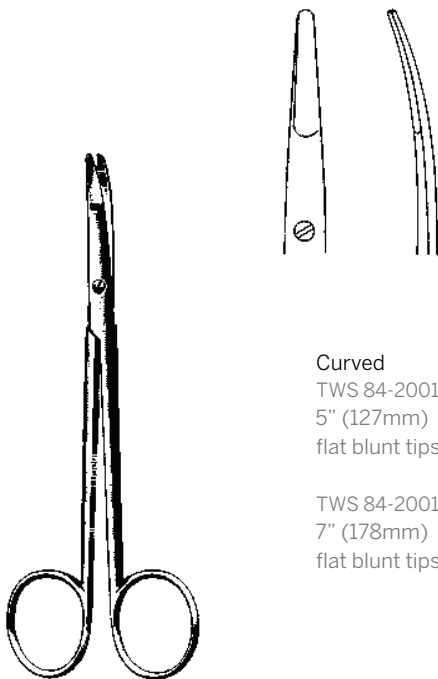

**RAGNELL SCISSORS**

**Curved**

- TWS 84-2001/46
- 5" (127mm)
- flat blunt tips

- TWS 84-2001/47
- 7" (178mm)
- flat blunt tips

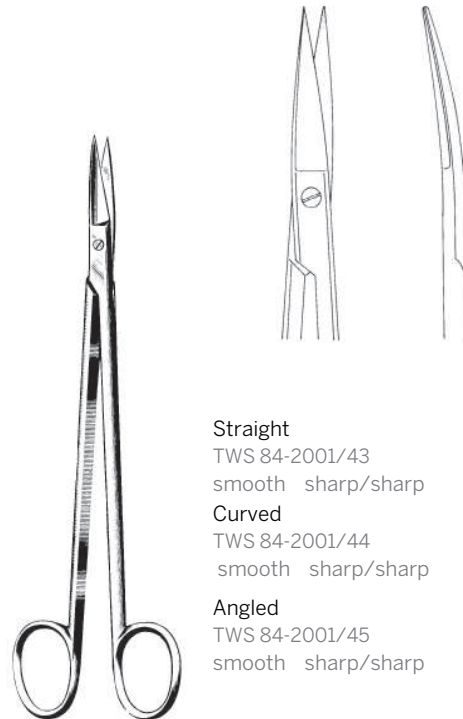

**KELLY FISTULA SCISSORS**  
6 1/4" (159mm)

**Straight**

- TWS 84-2001/43
- smooth sharp/sharp

**Curved**

- TWS 84-2001/44
- smooth sharp/sharp

**Angled**

- TWS 84-2001/45
- smooth sharp/sharp



TW Surgical

# DISSECTING SCISSORS

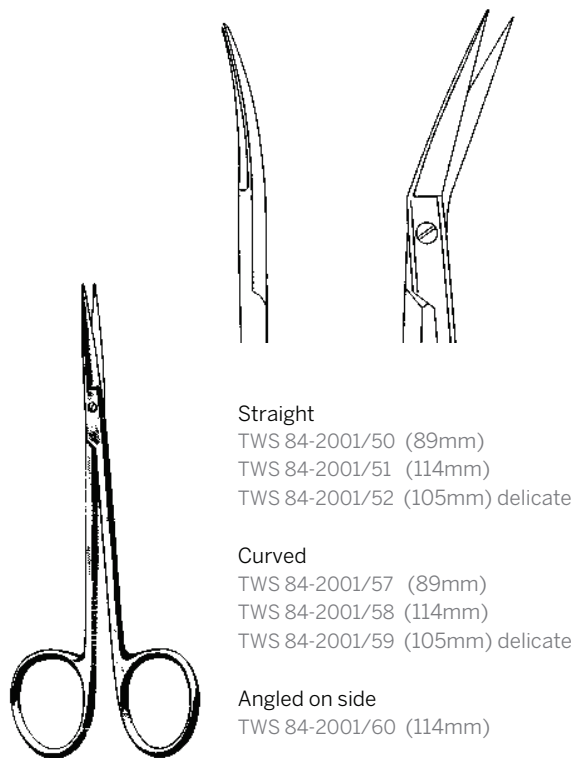

**Straight**  
 TWS 84-2001/50 (89mm)  
 TWS 84-2001/51 (114mm)  
 TWS 84-2001/52 (105mm) delicate

**Curved**  
 TWS 84-2001/57 (89mm)  
 TWS 84-2001/58 (114mm)  
 TWS 84-2001/59 (105mm) delicate

**Angled on side**  
 TWS 84-2001/60 (114mm)

**IRIS SCISSORS**  
Sharp points

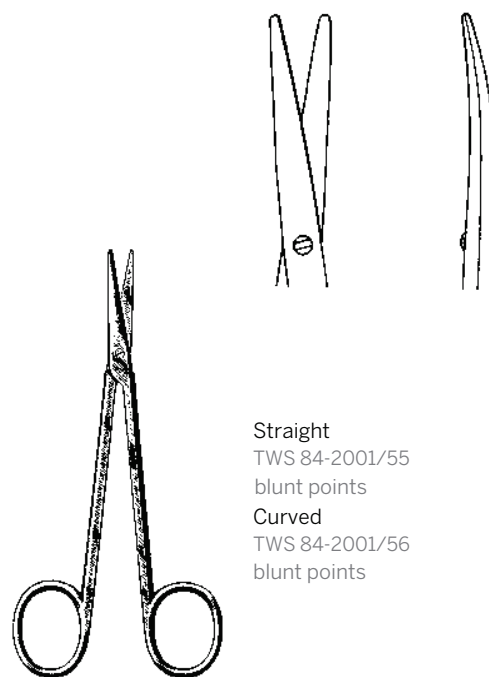

**Straight**  
 TWS 84-2001/55  
 blunt points

**Curved**  
 TWS 84-2001/56  
 blunt points

**STRABISMUS SCISSORS**  
4" (102mm)

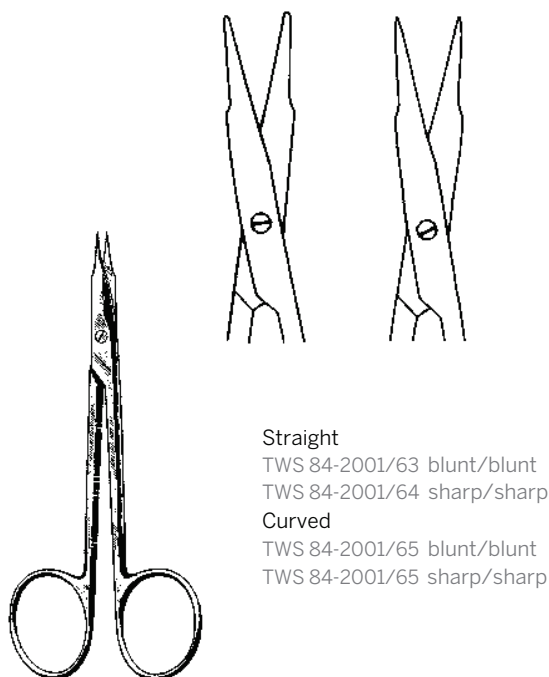

**Straight**  
 TWS 84-2001/63 blunt/blunt  
 TWS 84-2001/64 sharp/sharp

**Curved**  
 TWS 84-2001/65 blunt/blunt  
 TWS 84-2001/65 sharp/sharp

**STEVENS TENOTOMY SCISSORS**  
4 1/4" (108mm)

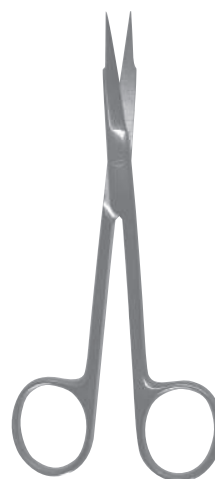

**Straight**  
 TWS 84-2001/66 (95mm)

**Curved**  
 TWS 84-2001/67 (102mm)

**IRIS SCISSORS RIBBON TYPE**

## DISSECTING SCISSORS/SUTURE SCISSORS

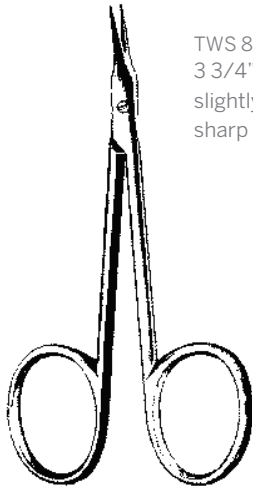

TWS 84-2001/68  
3 3/4" (95mm)  
slightly curved sharp/  
sharp

**GRADLE SCISSORS**



TWS 84-2001/69  
4" (102mm)  
slightly curved ribbon  
type  
sharp/sharp

**GRADLE SCISSORS**

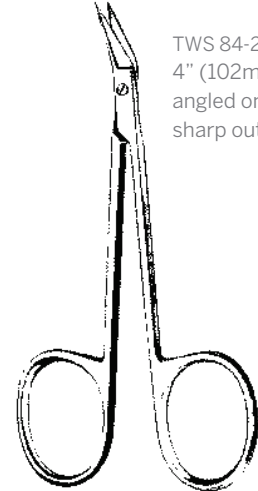

TWS 84-2001/70  
4" (102mm)  
angled on flat  
sharp outside edges

**BIRO DERMAL  
NAEVUS SCISSORS**



TWS 84-2001/71  
4 5/8" (117.5mm)  
with suture hole

TWS 84-2001/72  
4 5/8" (117.5mm)  
with suture hole  
super cut

**LITTLER SCISSORS**



TWS 84-2001/73  
3 1/2" (89mm)  
curved stainless

**NAIL SCISSORS**



TW Surgical

## SUTURE SCISSORS

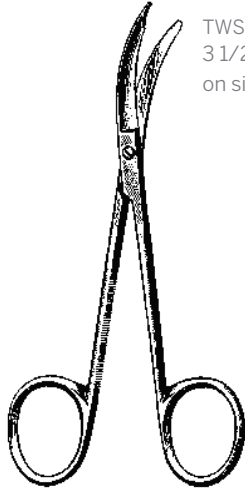

TWS 84-2001/74  
3 1/2" (89mm) curved  
on side delicate

**SHORTBENT STITCH  
SCISSORS**

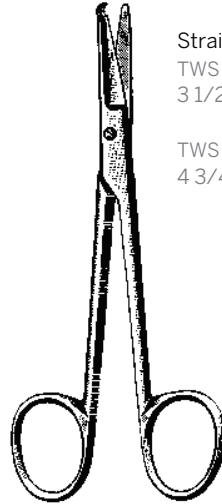

Straight  
TWS 84-2001/75  
3 1/2" (89mm) delicate

TWS 84-2001/76  
4 3/4" (121mm) delicate

**SPENCER STITCH  
SCISSORS**

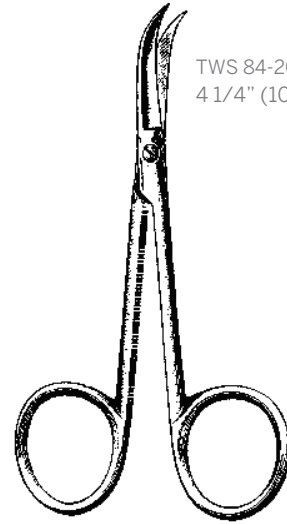

TWS 84-2001/77  
4 1/4" (108mm)

**HILL STITCH  
SCISSORS**

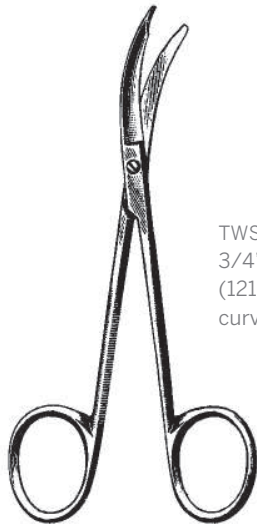

TWS 84-2001/78  
3/4"  
(121mm)  
curved on side

**NORTHBENT STITCH SCISSORS**

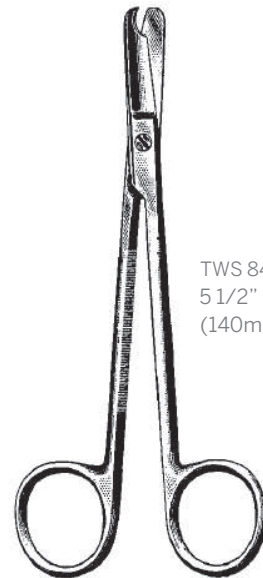

TWS 84-2001/79  
5 1/2"  
(140mm)

**LITTAUER STITCH SCISSORS**



TW Surgical

## TUNGSTEN CARBIDE SCISSORS

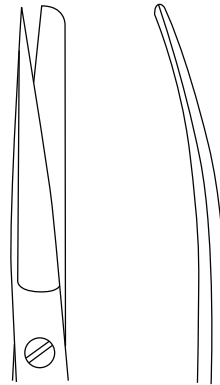
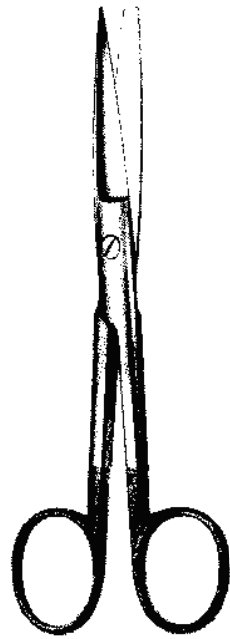

**Straight**  
TWS 84-2001/80  
5 1/2" (140mm)sharp/  
blunt

**Curved**  
TWS 84-2001/81  
5 1/2" (140mm)sharp/  
blunt

### TC OPERATING SCISSORS

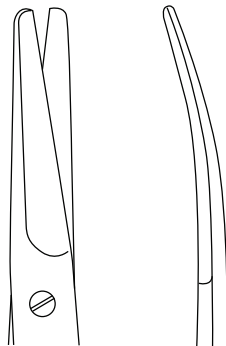

**Straight**  
TWS 84-2001/87 (140mm)  
TWS 84-2001/88 (171mm)  
TWS 84-2001/89 (229mm)

**Curved**  
TWS 84-2001/90 (140mm)  
TWS 84-2001/91 (171mm)  
TWS 84-2001/92 (229mm)

### TC MAYO SCISSORS

Beveled blades



**Straight**  
TWS 84-2001/93 (152mm)  
TWS 84-2001/94 (178mm)  
TWS 84-2001/95 (229mm)

**Curved**  
TWS 84-2001/96 (152mm)  
TWS 84-2001/97 (178mm)  
TWS 84-2001/98 (229mm)

### TC METZENBAUM SCISSORS

Blunt points



TW Surgical

# TUNGSTEN CARBIDE SCISSORS/BANDAGE SCISSORS

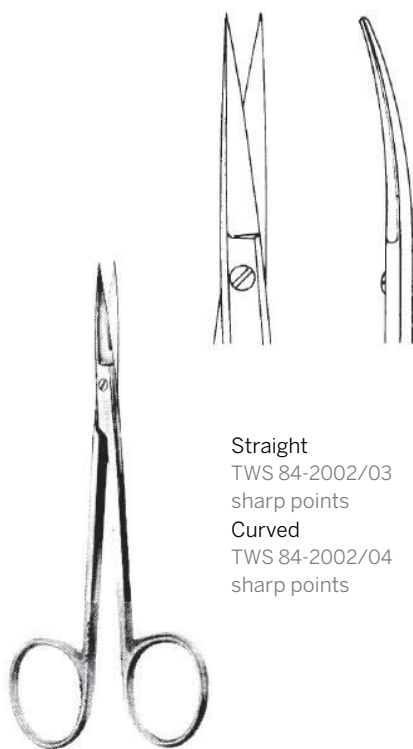

Straight  
TWS 84-2002/03  
sharp points  
Curved  
TWS 84-2002/04  
sharp points

**TC IRIS SCISSORS**  
4 1/2" (114mm)

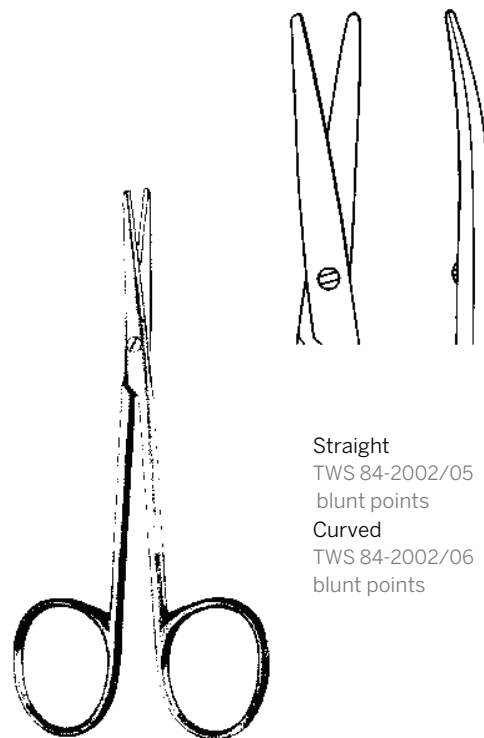

Straight  
TWS 84-2002/05  
blunt points  
Curved  
TWS 84-2002/06  
blunt points

**TC STRABISMUS SCISSORS**  
4 1/2" (114mm)

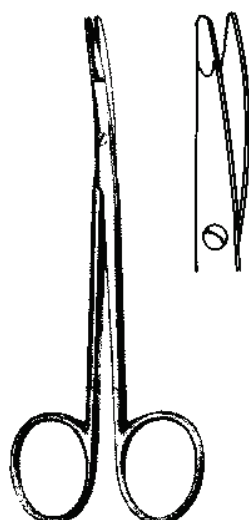

Curved  
TWS 84-2002/07  
4 1/2" (114mm)  
flat tips,  
one serrated and  
one carbide blade

**BLEPHAROPLASTY SCISSORS**

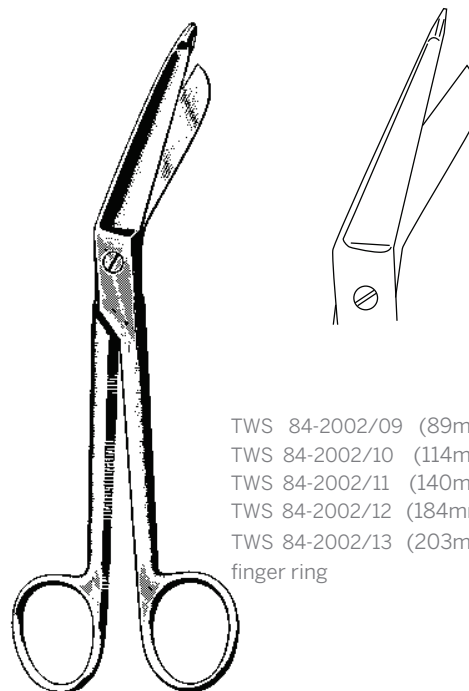

TWS 84-2002/09 (89mm)  
TWS 84-2002/10 (114mm)  
TWS 84-2002/11 (140mm)  
TWS 84-2002/12 (184mm)  
TWS 84-2002/13 (203mm) one large  
finger ring

**LISTER BANDAGE SCISSORS**



TW Surgical

## BANDAGE SCISSORS

*The delicate offset shanks provide better leverage. The fine knob slides easily under finger and toe bandages.*

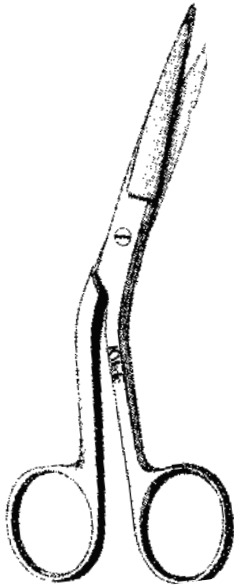

TWS 84-2002/14  
5 1/2" (140mm)  
shanks angled on side  
one serrated blade

**HI-LEVEL BANDAGE SCISSORS**

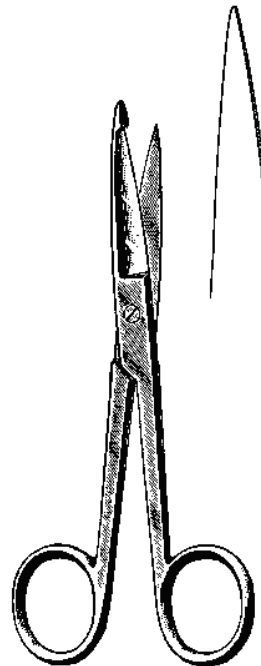

**Straight**  
TWS 84-2002/15  
5 1/2" (140mm)  
one serrated blade

**KNOWLES BANDAGE SCISSORS**

*For finger and toe bandages.*

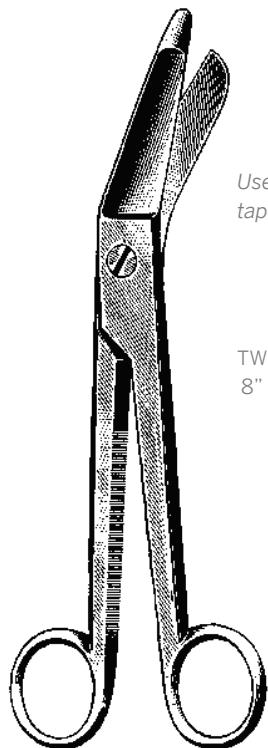

*Useful for cutting tape and bandages.*

TWS 84-2002/16  
8" (203mm)

**ESMARCH SHEARS**

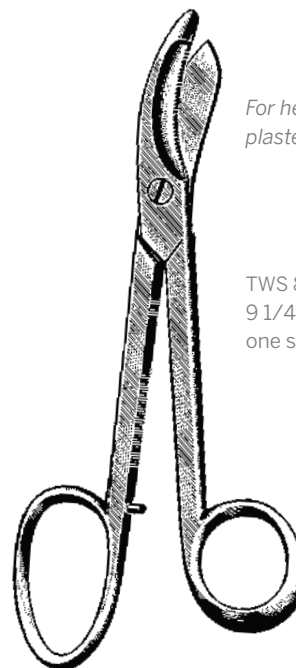

*For heavier plaster.*

TWS 84-2002/17  
9 1/4" (235mm)  
one serrated blade

**BRUNS SHEARS**



TW Surgical

## UTILITY SCISSORS

*For light plaster and cloth.*

*With autoclavable plastic finger rings.*

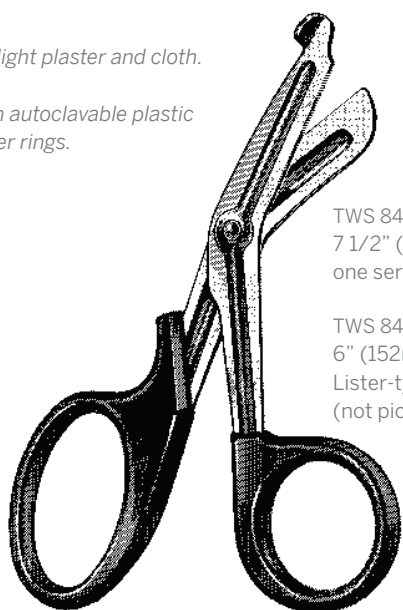

TWS 84-2002/18  
7 1/2" (191mm)  
one serrated blade

TWS 84-2002/19  
6" (152mm)  
Lister-type  
(not pictured)

**UTILITY SCISSORS**

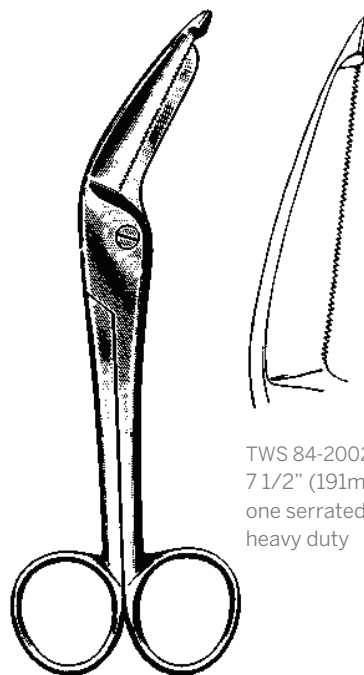

TWS 84-2002/20  
7 1/2" (191mm)  
one serrated blade  
heavy duty

**HERCULES SCISSORS**



*Effective for cloth or cotton wadding.*

TWS 84-2002/21  
8" (203mm)  
with wire cutting notch  
one serrated blade

**UTILITY SHEARS**



TWS 84-2002/22  
Pink handle

TWS 84-2002/23  
Blue handle

**NURSES SCISSORS**  
5 1/2" (140mm)



TW Surgical

## WIRE CUTTING SCISSORS/HEMOSTATIC FORCEPS

Notch for cutting cerclage wire up to 1mm.

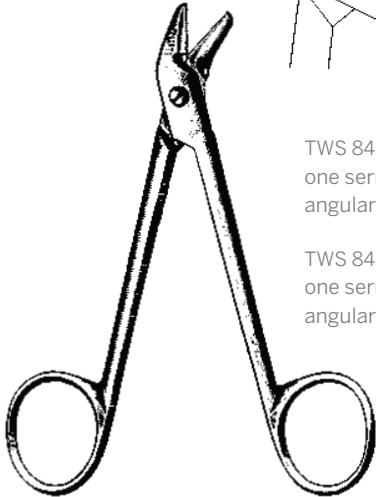
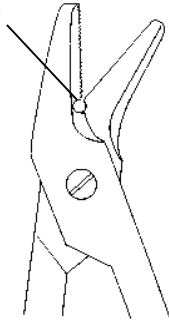

TWS 84-2002/25  
one serrated blade  
angular

TWS 84-2002/26  
one serrated blade  
angular carbide

### WIRE CUTTING SCISSORS

4 3/4" (121mm)

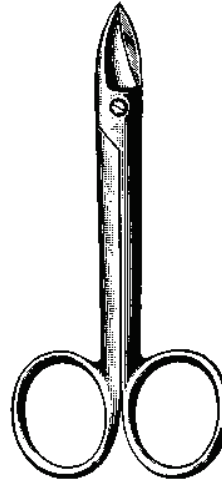

Straight  
TWS 84-2002/28  
smooth

TWS 84-2002/29  
one serrated blade

Curved  
TWS 84-2002/30  
smooth

TWS 84-2002/31  
one serrated blade

### WIRE CUTTING SCISSORS

4" (102mm)

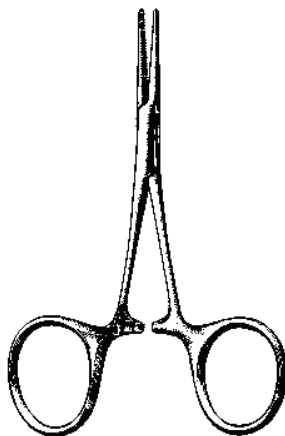

Straight  
TWS 84-2002/36

Curved  
TWS 84-2002/37

### HARTMANN MOSQUITO FORCEPS

3 1/2" (89mm)

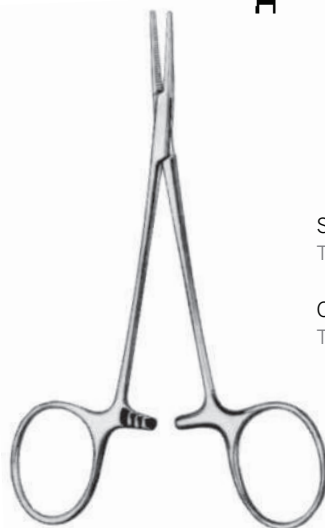
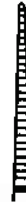

Straight  
TWS 84-2002/38

Curved  
TWS 84-2002/39

### MICRO MOSQUITO FORCEPS

5" (127mm) Extremely fine tips

Treasure Wright (U.K.) Ltd.

128-160 City Road, London, EC1V 2NX, United Kingdom  
info@twrightmedical.com



TW Surgical

# HEMOSTATIC FORCEPS

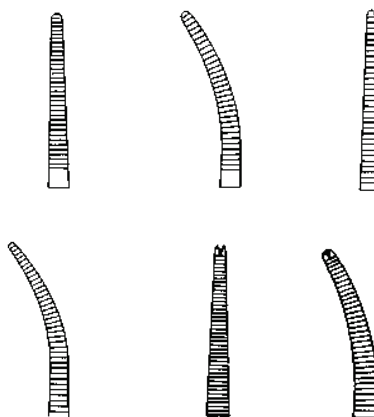
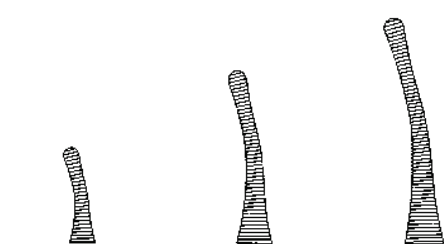

- Straight**  
 TWS 84-2002/46 1/2" (38mm)  
 TWS 84-2002/47 2" (51mm)  
 TWS 84-2002/48 2 1/2" (64mm)  
 TWS 84-2002/49 3" (76mm)  
 TWS 84-2002/50 1/2" (89mm)
- Curved**  
 TWS 84-2002/51 1/2" (38mm)  
 TWS 84-2002/52 2" (51mm)  
 TWS 84-2002/53 2 1/2" (64mm)  
 TWS 84-2002/54 3" (76mm)  
 TWS 84-2002/55 3 1/2" (89mm)

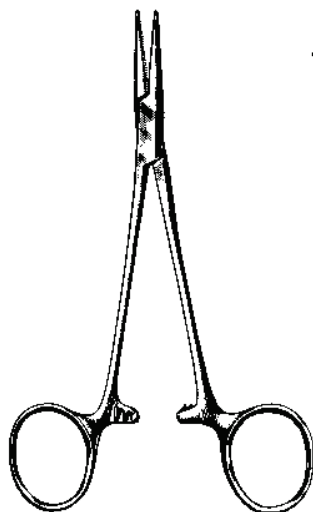

- Straight**  
 TWS 84-2002/59  
 TWS 84-2002/60 delicate  
 TWS 84-2002/61 1x2 teeth
- Curved**  
 TWS 84-2002/62  
 TWS 84-2002/63 delicate  
 TWS 84-2002/64 2x2 teeth

## JOHNS HOPKINS BULLDOG CLAMPS

## HALSTED MOSQUITO FORCEPS 5" (127mm)

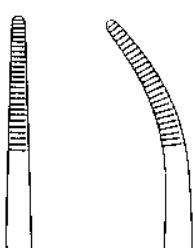
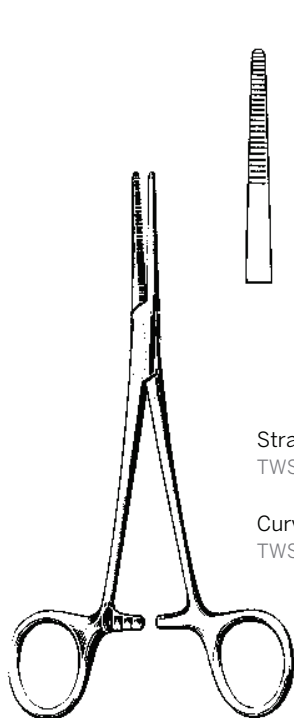

- Straight**  
TWS 84-2002/71
- Curved**  
TWS 84-2002/72

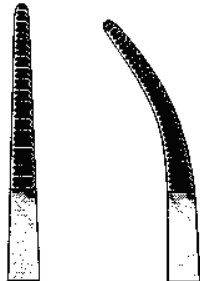
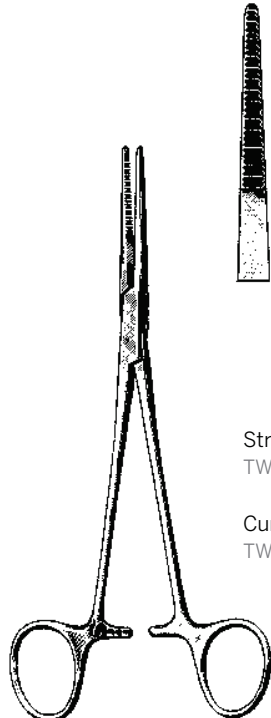

- Straight**  
TWS 84-2002/73
- Curved**  
TWS 84-2002/74

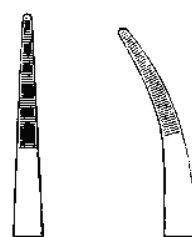
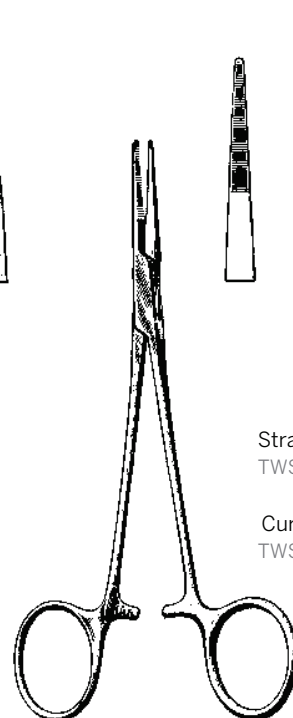

- Straight**  
TWS 84-2002/76
- Curved**  
TWS 84-2002/75

## KELLY FORCEPS 5 1/2" (140mm)

## RANKIN-KELLY FORCEPS 6 1/4" (159mm)

## PROVIDENCE HOSPITAL FORCEPS 5 1/2" (140mm)



TW Surgical

## HEMOSTATIC FORCEPS

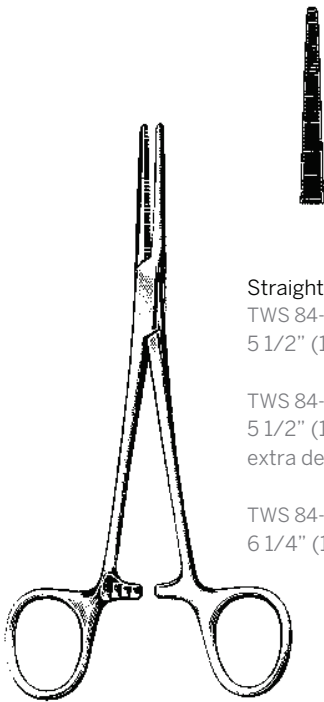

### Straight

TWS 84-2002/95  
5 1/2" (140mm)

TWS 84-2002/97  
5 1/2" (140mm)  
extra delicate

TWS 84-2002/99  
6 1/4" (159mm)



### Curved

TWS 84-2002/96  
5 1/2" (140mm)

TWS 84-2002/98  
5 1/2" (140mm)  
extra delicate

TWS 84-2003/00  
6 1/4" (159mm)

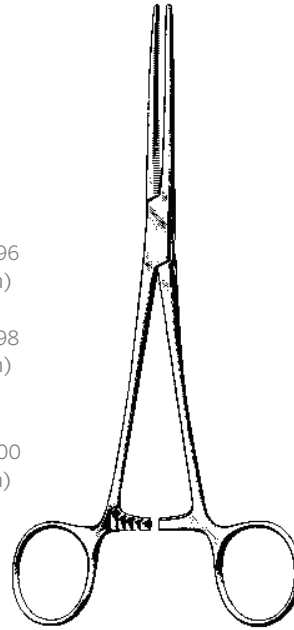

### Straight

TWS 84-2002/81 5 1/2" (140mm)  
TWS 84-2002/82 6 1/4" (159mm)  
TWS 84-2002/83 7 1/4" (184mm)  
TWS 84-2002/84 8" (203mm)  
TWS 84-2002/85 9" (229mm)  
TWS 84-2002/86 10" (254mm)  
TWS 84-2002/87 12" (305mm)

### Curved

TWS 84-2002/88 1 1/2" (140mm)  
TWS 84-2002/89 6 1/4" (159mm)  
TWS 84-2002/90 7 1/4" (184mm)  
TWS 84-2002/91 8" (203mm)  
TWS 84-2002/92 9" (229mm)  
TWS 84-2002/93 10" (254mm)  
TWS 84-2002/94 12" (305mm)

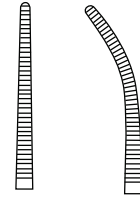

## CRILE FORCEPS

## ROCHESTER PEAN FORCEPS

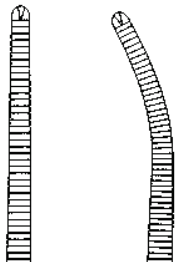
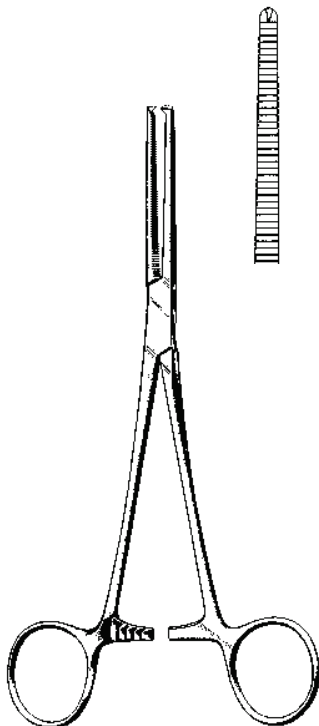

### Straight

TWS 84-2003/01  
5 1/2" (140mm)

TWS 84-2003/05  
6 1/4" (159mm)

TWS 84-2003/08  
7 1/4" (184mm)

TWS 84-2003/10  
8" (203mm)

TWS 84-2003/12  
9" (229mm)

TWS 84-2003/14  
10" (254mm)

### Curved

TWS 84-2003/04  
5 1/2" (140mm)

TWS 84-2003/06  
6 1/4" (159mm)

TWS 84-2003/09  
7 1/4" (184mm)

TWS 84-2003/11  
8" (203mm)

TWS 84-2003/13  
9" (229mm)

TWS 84-2003/15  
10" (254mm)

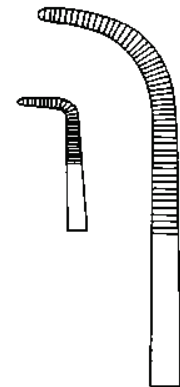
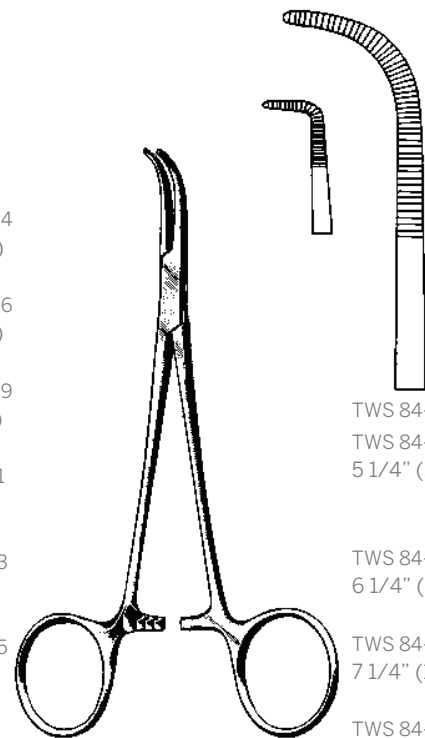

TWS 84-2003/16  
TWS 84-2003/17  
5 1/4" (133mm) delicate

TWS 84-2003/18  
6 1/4" (159mm)

TWS 84-2003/19  
7 1/4" (184mm)

TWS 84-2003/20  
9" (229mm)

## ROCHESTER-OGHSNER FORCEPS

1 x 2 Teeth

## MIXTER FORCEPS

Fully curved

Treasure Wright (U.K.) Ltd.

128-160 City Road, London, EC1V 2NX, United Kingdom  
info@twrightmedical.com



TW Surgical

# HEMOSTATIC FORCEPS



TWS 84-2003/21  
7" (171mm)  
serrated

**GEMINI MIXTER FORCEPS**

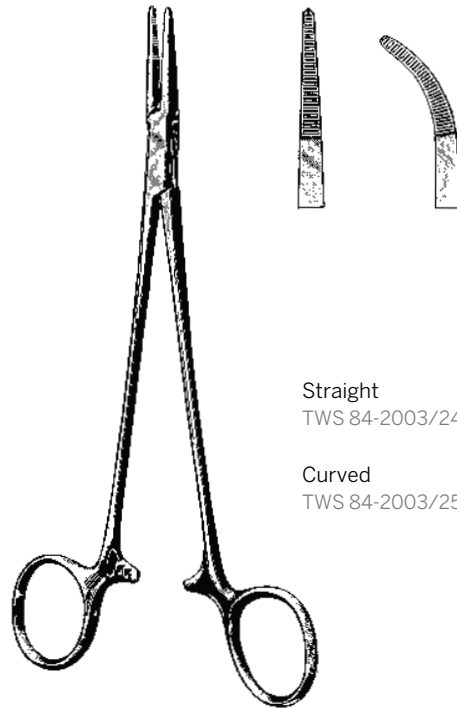

Straight  
TWS 84-2003/24

Curved  
TWS 84-2003/25

**ADSON HEMOSTATIC FORCEPS**

7 1/4" (184mm)



Straight  
TWS 84-2003/28  
6 1/4" (159mm)

TWS 84-2003/29  
8" (203mm)

Curved  
TWS 84-2003/30  
6 1/4" (159mm)

TWS 84-2003/31  
8" (203mm)

**ROCHESTER-CARMALT FORCEPS**



Straight  
TWS 84-2003/33  
6 1/2" (165mm)

TWS 84-2003/34  
7 1/2" (191mm)

Curved  
TWS 84-2003/36  
6 1/2" (165mm)

TWS 84-2003/35  
7 1/2" (191mm)

**FERGUSON ANGIOTRIBE FORCEPS**



TW Surgical

# HEMOSTATIC FORCEPS

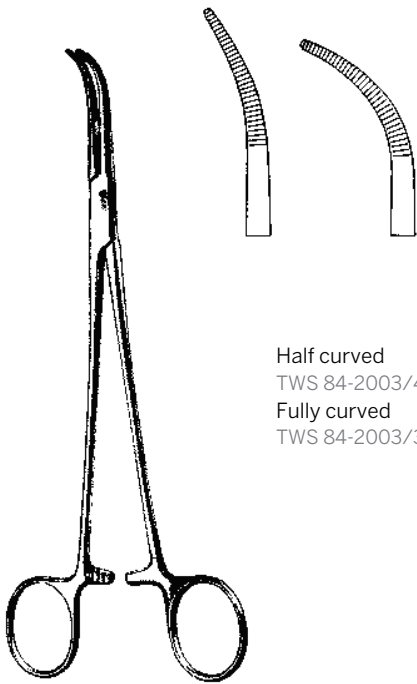

Half curved  
TWS 84-2003/40  
Fully curved  
TWS 84-2003/39

**SCHNIDT FORCEPS**  
7 1/2" (191mm)

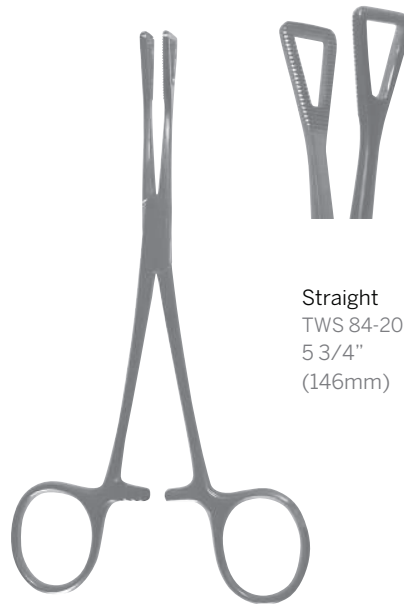

Straight  
TWS 84-2003/41  
5 3/4"  
(146mm)

**PENNINGTON FORCEPS**

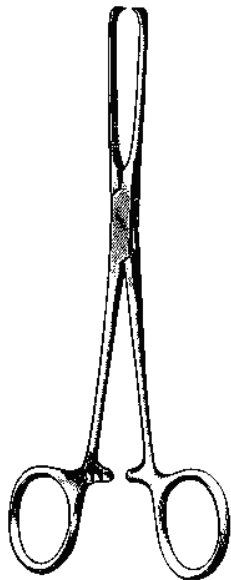

TWS 84-2003/43 4 3/4"  
(121mm)4x5 teeth delicate  
TWS 84-2003/44 5 3/4"  
(146mm)4x5 teeth delicate  
TWS 84-2003/45 6"  
(152mm)3x4 teeth standard  
TWS 84-2003/46 6"  
(152mm)4x5 teeth standard  
TWS 84-2003/47 6"  
(152mm)5x6 teeth standard  
TWS 84-2003/48 10"  
5x6 teeth standard  
TWS 84-2003/49 12"  
5x6 teeth standard

**ALLIS TISSUE FORCEPS**



TWS 84-2003/50  
7 1/2" (191mm)5x6 teeth

**ALLIS TISSUE FORCEPS**



TW Surgical

# INTESTINAL FORCEPS



TWS 84-2003/51"  
(152mm)3x4 teeth

**ALLIS-JUDD TISSUE FORCEPS**

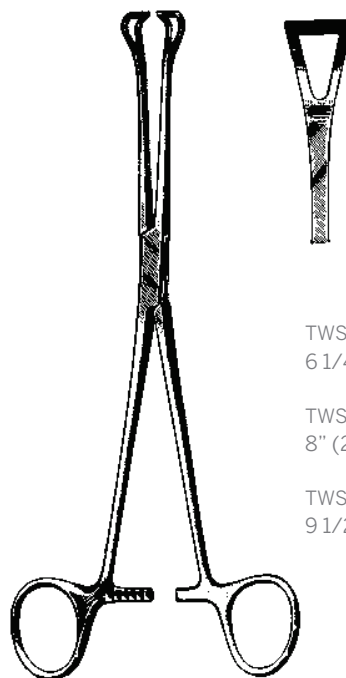

TWS 84-2003/53  
6 1/4" (159mm)

TWS 84-2003/54  
8" (203mm)

TWS 84-2003/55  
9 1/2" (241mm)

**BABCOCK FORCEPS**

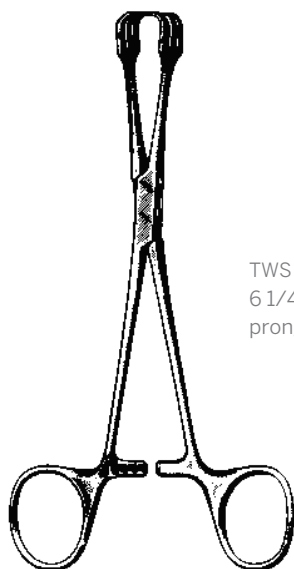

TWS 84-2003/56  
6 1/4" (159mm)3x3  
prongs

**LAHEY VULSELLUM FORCEPS**

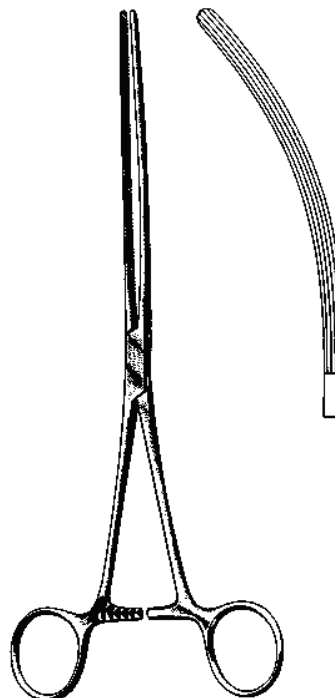

Straight  
TWS 84-2003/59

Curved  
TWS 84-2003/58

**DOYEN CLAMP**  
9" (229mm) Longitudinal serrations



TW Surgical

# INTESTINAL FORCEPS/TUBING AND UTILITY FORCEPS

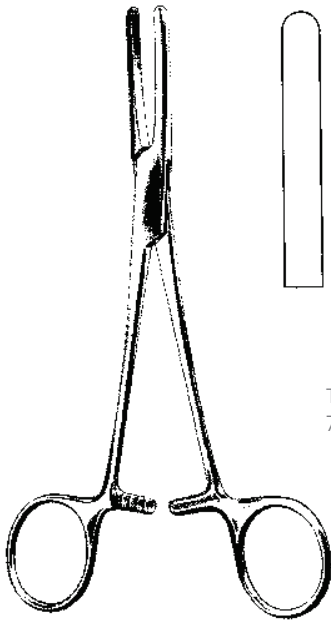

TWS 84-2003/61  
7" (178mm) smooth

**PRESBYTERIAN TUBE OCCLUDING FORCEPS**

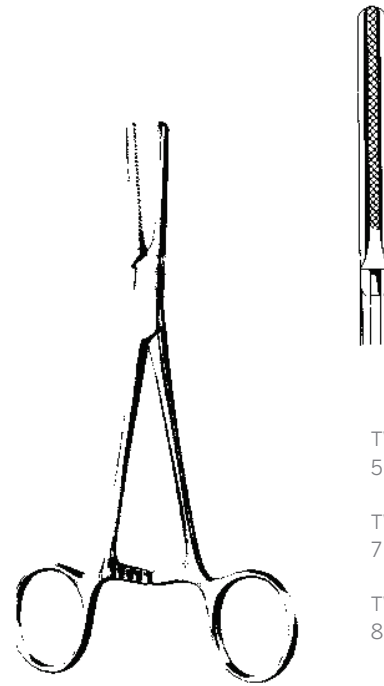

TWS 84-2003/63  
5 1/2" (140mm)

TWS 84-2003/64  
7 1/4" (184mm)

TWS 84-2003/65  
8" (203mm)

**VORSE TUBE OCCLUDING FORCEPS**  
Serrated

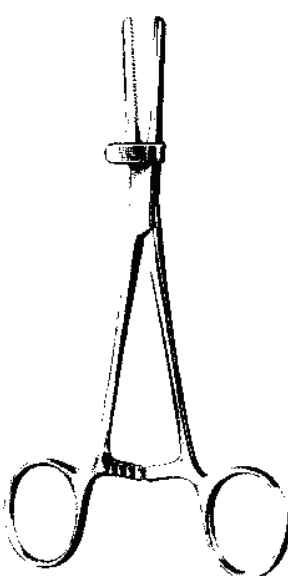

TWS 84-2003/67 5 1/2" (140mm)  
TWS 84-2003/68 7 1/4" (184mm)  
TWS 84-2003/69 8" (203mm)

**VORSE TUBE OCCLUDING FORCEPS**  
Serrated, with guard

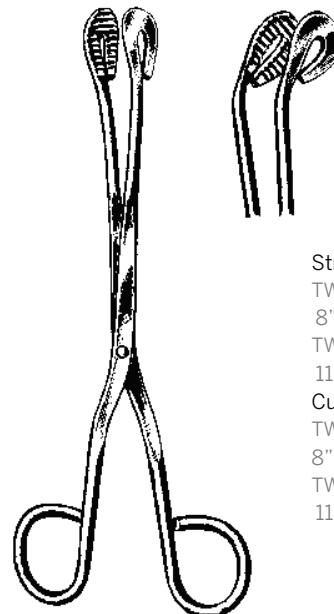

Straight  
TWS 84-2003/70  
8" (203mm)  
TWS 84-2003/71  
11" (279mm)  
Curved  
TWS 84-2003/72  
8" (203mm)  
TWS 84-2003/73  
11" (279mm)

**UTILITY AND STERILIZER FORCEPS**



TW Surgical

# TUBING AND UTILITY FORCEPS/TOWEL AND SPONGE FORCEPS

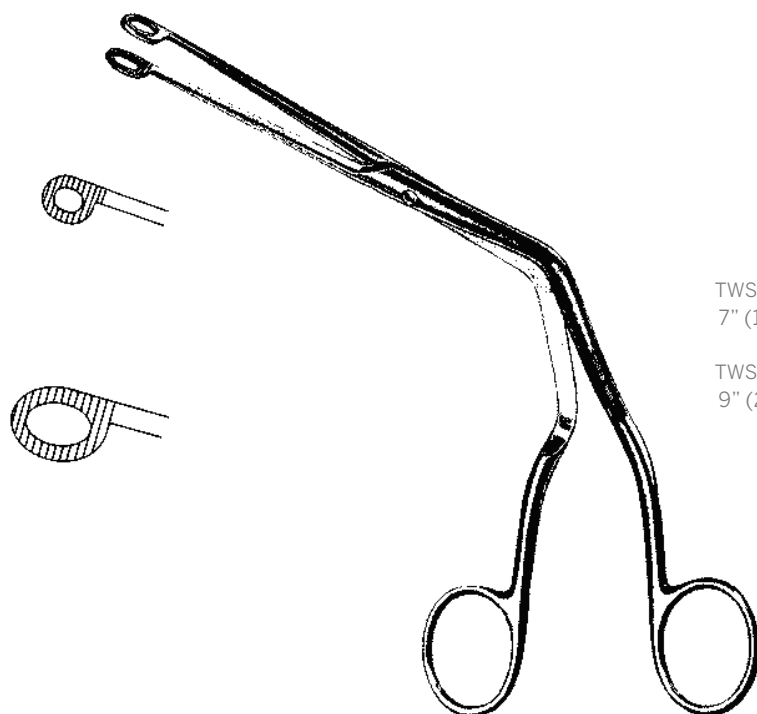

TWS 84-2003/74  
7" (178mm)child

TWS 84-2003/75  
9" (229mm)adult

## MAGILL ENDOTRACHEAL CATHETER INTRODUCING FORCEPS



TWS 84-2003/76  
2 1/2" (64mm)

TWS 84-2003/77  
3 1/4" (83mm)

## JONES TOWEL FORCEPS



TWS 84-2003/78  
3 1/2" (89mm)

TWS 84-2003/79  
5 1/4" (133mm)

## BACKHAUS TOWEL FORCEPS

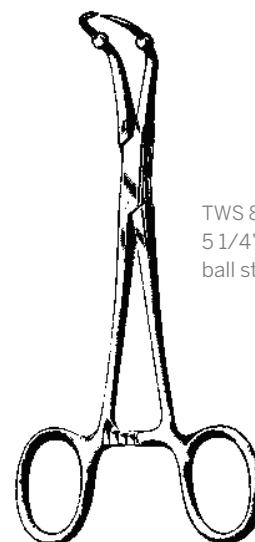

TWS 84-2003/80  
5 1/4" (133mm)with  
ball stops

## BACKHAUS-ROEDER TOWEL CLAMP



TW Surgical

## TOWEL AND SPONGE FORCEPS/DRESSING AND TISSUE FORCEPS

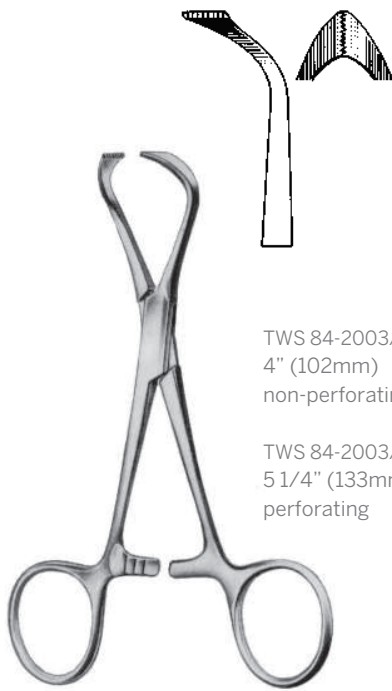

TWS 84-2003/82  
4" (102mm)  
non-perforating

TWS 84-2003/83  
5 1/4" (133mm) non-perforating

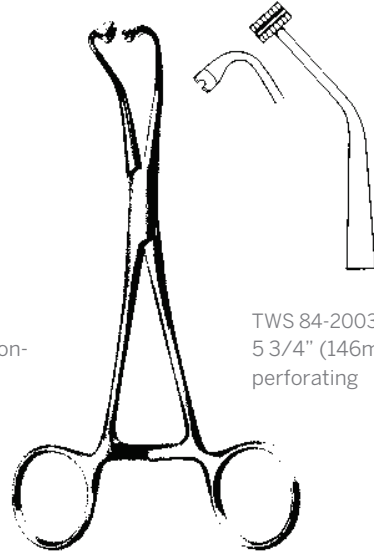

TWS 84-2003/90  
5 3/4" (146mm) non-perforating



Straight  
TWS 84-2003/84 7" (178mm)  
TWS 84-2003/85 9 1/2" (241mm)

Straight, smooth  
TWS 84-2003/86 7" (178mm)  
TWS 84-2003/87 9 1/2" (241mm)

Curved, serrated  
TWS 84-2003/88 7" (178mm)  
TWS 84-2003/89 9 1/2" (241mm)

Curved, smooth  
TWS 84-2003/91 7" (178mm)  
TWS 84-2003/92 9 1/2" (241mm)

**LORNA (EDNA) TOWEL CLAMP**

**PEERS TOWEL CLAMP**

**FOERSTER SPONGE FORCEPS**



TWS 84-2003/94 4 1/2" (114mm)  
TWS 84-2003/95 5" (127mm)  
TWS 84-2003/96 5 1/2" (140mm)  
TWS 84-2003/97 6" (152mm)  
TWS 84-2003/98 8" (203mm)  
TWS 84-2003/99 10" (254mm)  
TWS 84-2004/00 12" (305mm)

**DRESSING FORCEPS**  
Serrated

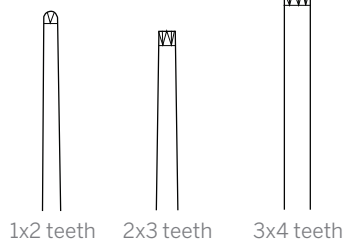

1x2 teeth  
TWS 84-2004/01 4 1/2" (114mm)  
TWS 84-2004/02 5" (127mm)  
TWS 84-2004/03 5 1/2" (140mm)  
TWS 84-2004/04 6" (152mm)  
TWS 84-2004/05 8" (203mm)  
TWS 84-2004/06 10" (254mm)  
TWS 84-2004/07 12" (305mm)

2x3 teeth  
TWS 84-2004/08 5" (127mm)  
TWS 84-2004/09 5 1/2" (140mm)

3x4 teeth  
TWS 84-2004/10  
5 1/2" (140mm)

**TISSUE FORCEPS**

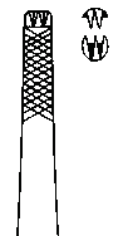
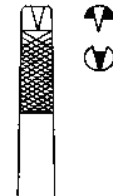

1x2 teeth  
TWS 84-2004/11

2x3 teeth  
TWS 84-2004/12

**FERRIS-SMITH TISSUE FORCEPS**  
7" (178mm) with platform



TW Surgical

# DRESSING AND TISSUE FORCEPS

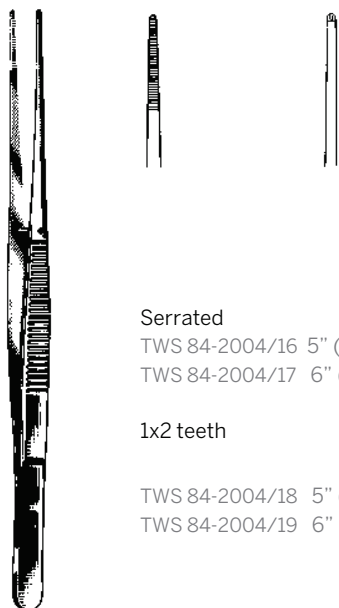

Serrated  
TWS 84-2004/16 5" (127mm)  
TWS 84-2004/17 6" (152mm)

1x2 teeth  
TWS 84-2004/18 5" (127mm)  
TWS 84-2004/19 6" (152mm)

## SEMKEN FORCEPS

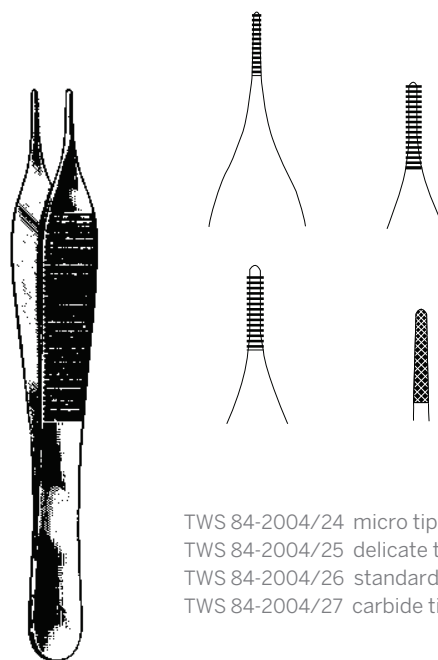

TWS 84-2004/24 micro tip  
TWS 84-2004/25 delicate tip  
TWS 84-2004/26 standard tip  
TWS 84-2004/27 carbide tip

## ADSON DRESSING FORCEPS

4 3/4" (121mm) serrated



1x2 teeth  
TWS 84-2004/35 micro tip  
TWS 84-2004/36 serrated tip  
TWS 84-2004/37 delicate tip  
TWS 84-2004/38 standard tip  
TWS 84-2004/39 delicate, with tying platform  
TWS 84-2004/40 carbide tip

2x3 teeth  
TWS 84-2004/41

## ADSON TISSUE FORCEPS

4 3/4" (121mm)

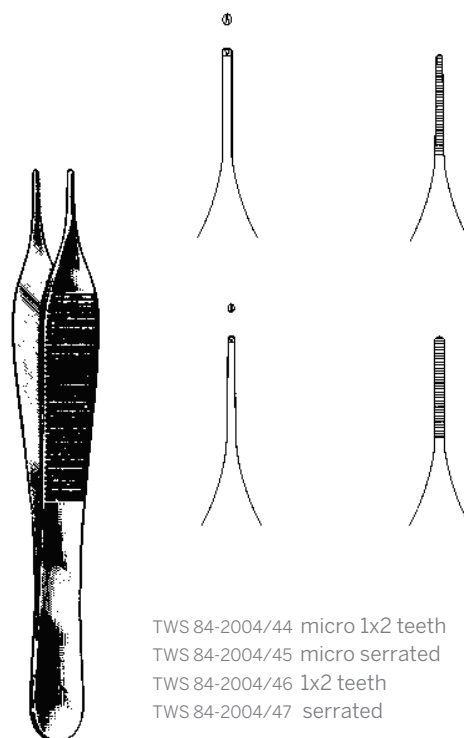

TWS 84-2004/44 micro 1x2 teeth  
TWS 84-2004/45 micro serrated  
TWS 84-2004/46 1x2 teeth  
TWS 84-2004/47 serrated

## ADSON DRESSING AND TISSUE FORCEPS

6" (152mm)



TW Surgical

## DRESSING AND TISSUE FORCEPS

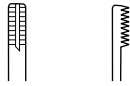

TWS 84-2004/48  
4 3/4" (121mm)  
9x9 teeth  
side grasping

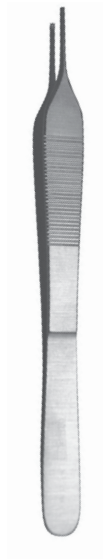

TWS 84-2004/49  
7" (178mm) 3mm  
2x3 teeth

TWS 84-2004/50  
7" (178mm) 3mm  
2x3 teeth  
with carbide inserts



TWS 84-2004/51

### ADSON BROWN TISSUE FORCEPS

### ADSON TISSUE FORCEPS

### ADSON TISSUE FORCEPS

TC 1S2 Teeth SERR. 6"



TWS 84-2004/53 4 1/2" (114mm)  
TWS 84-2004/54 5" (127mm)  
TWS 84-2004/55 5 1/2" (140mm)  
TWS 84-2004/56 6" (152mm)

### DRESSING FORCEPS

Serrated with fluted handles



TWS 84-2004/57 4 1/2" (114mm)  
TWS 84-2004/58 5" (127mm)  
TWS 84-2004/59 5 1/2" (140mm)  
TWS 84-2004/60 6" (152mm)

### TISSUE FORCEPS

1x2 teeth with fluted handles

Treasure Wright (U.K.) Ltd.

128-160 City Road, London, EC1V 2NX, United Kingdom  
info@twrightmedical.com



TW Surgical

# DRESSING AND TISSUE FORCEPS

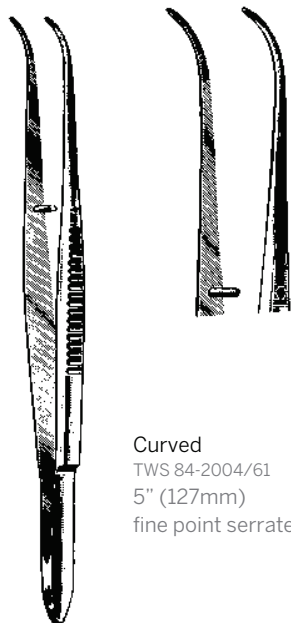

Curved  
TWS 84-2004/61  
5" (127mm)  
fine point serrated



TWS 84-2004/68 6" (152mm)  
TWS 84-2004/69 8" (203mm)  
TWS 84-2004/70 9" (229mm)  
TWS 84-2004/71 10" (254mm)

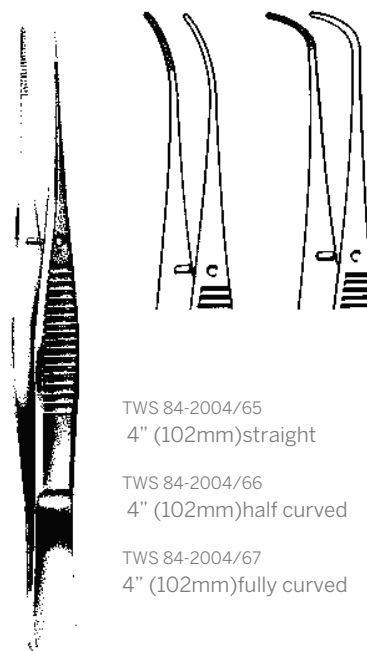

TWS 84-2004/65  
4" (102mm)straight  
TWS 84-2004/66  
4" (102mm)half curved  
TWS 84-2004/67  
4" (102mm)fully curved

## DRESSING FORCEPS

## RUSSIAN TISSUE FORCEPS

## EYE DRESSING FORCEPS

4" (102mm) serrated



TWS 84-2004/79 6 1/4" (159mm) 1.5mm  
TWS 84-2004/80 8" (203mm) 1.5mm  
TWS 84-2004/81 9 1/4" (235mm) 1.5mm  
TWS 84-2004/82 6 1/4" (159mm) 2.0mm  
TWS 84-2004/83 8" (203mm) 2.0mm  
TWS 84-2004/84 9 1/4" (235mm) 2.0mm  
TWS 84-2004/85 6 1/4" (159mm) 3.5mm  
TWS 84-2004/86 8" (203mm) 3.5mm  
TWS 84-2004/87 9 1/4" (235mm) 3.5mm

## DEBAKEY ATRAUMATIC TISSUE FORCEPS

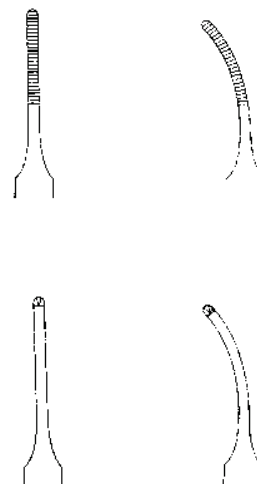

TWS 84-2004/88 straight serrated  
TWS 84-2004/89 curved serrated  
TWS 84-2004/90 straight 1x2 teeth  
TWS 84-2004/91 curved 1x2 teeth



## GRAEFE EYE DRESSING FORCEPS

2 1/2" (64mm)



TW Surgical

## DRESSING AND TISSUE FORCEPS

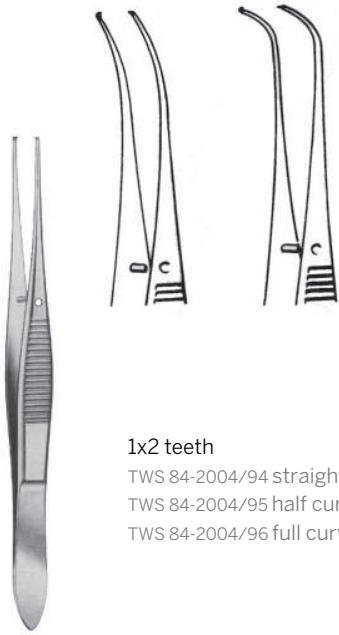

1x2 teeth  
TWS 84-2004/94 straight  
TWS 84-2004/95 half curved  
TWS 84-2004/96 full curved

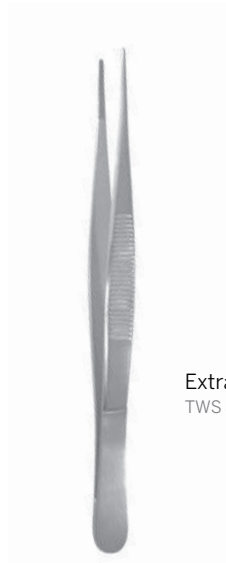

Extra narrow  
TWS 84-2004/97



1x2 teeth delicate  
TWS 84-2004/98 straight  
TWS 84-2004/99 curved  
TWS 84-2005/00 straight TC

### IRIS FORCEPS

4" (102mm)

### DRESSING FORCEPS

5 1/2" (140mm)

### GERALD DRESSING FORCEPS

6 3/4" (171mm)

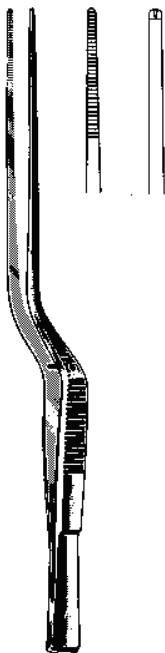

TWS 84-2005/01 1x2 teeth  
TWS 84-2005/02 serrated

### CUSHING BAYONET TISSUE FORCEPS

7 1/4" (184mm)

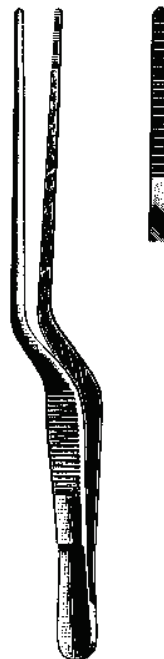

TWS 84-2005/03  
8 1/4" (210mm)  
straight with serrated tips

### ADSON BAYONET FORCEPS

8 1/4" (210mm)

Treasure Wright (U.K.) Ltd.

128-160 City Road, London, EC1V 2NX, United Kingdom  
info@twrightmedical.com



TW Surgical

## JEWELERS FORCEPS/SPLINTER FORCEPS



TWS 84-2005/04  
#3  
4 3/4" (121mm)  
narrow fine



TWS 84-2005/05  
#3C  
4 3/8" (111mm)  
narrow fine



TWS 84-2005/06  
#4  
4 3/8" (111mm)  
fine



TWS 84-2005/07  
#5  
4 3/8" (111mm)  
extra fine



TWS 84-2005/08  
#6  
4 1/2" (114mm)  
angled pickup



TWS 84-2005/09  
#7  
4 1/2" (114mm)  
curved fine

## SWISS JEWELERS STYLE FORCEPS

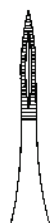
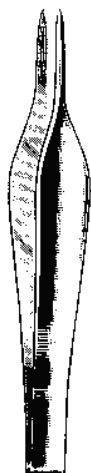

TWS 84-2005/11  
3 1/4" (83mm)

TWS 84-2005/12  
4 1/2" (114mm)



TWS 84-2005/14  
3 1/2" (89mm)

TWS 84-2005/15  
4 1/2" (114mm)



Straight  
TWS 84-2005/18

Curved  
TWS 84-2005/19

## FEILCHENFELD FORCEPS

## PLAIN SPLINTER FORCEPS

## CARMALT SPLINTER FORCEPS

Treasure Wright (U.K.) Ltd.

128-160 City Road, London, EC1V 2NX, United Kingdom  
info@twrightmedical.com



TW Surgical

## SPLINTER FORCEPS/NEEDLE HOLDERS

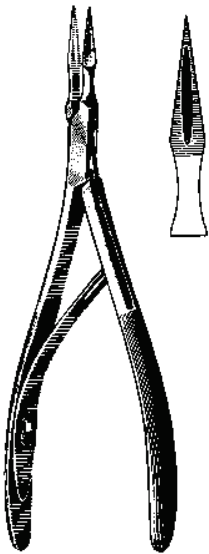

TWS 84-2005/20  
6" (152mm)  
serrated



TWS 84-2005/21  
5" (127mm)  
trocar in reversible handle

TWS 84-2005/22  
trocar point only

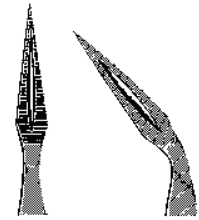
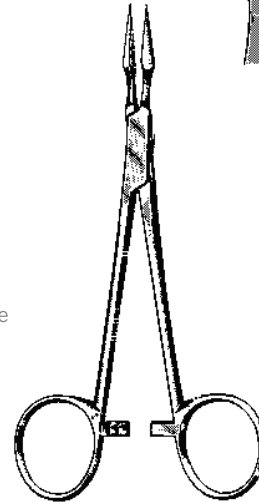

TWS 84-2005/25  
5 1/2" (140mm)  
straight

TWS 84-2005/26  
5 1/4" (133mm)  
45 degree angled

TWS 84-2005/27  
5 1/2" (140mm)  
90 degree angled

**VIRTUS SPLINTER FORCEPS**

**VANGUARD SPLINTER LIBERATOR**

**WILLIAMS SPLINTER FORCEPS**  
Serrated

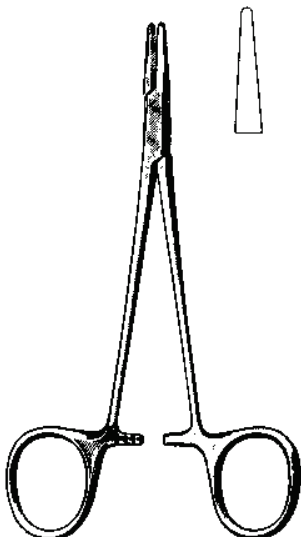

TWS 84-2005/32  
smooth

TWS 84-2005/33  
smooth carbide

TWS 84-2005/34  
serrated

TWS 84-2005/35  
serrated carbide

**HALSEY NEEDLE HOLDER**  
5" (127mm) Serrated



TWS 84-2005/36  
5" (127mm)  
serrated

TWS 84-2005/37  
5 3/4" (146mm)  
serrated

TWS 84-2005/38  
5 1/2" (140mm)  
serrated carbide

**HEGAR BAUMGARTNER NEEDLE HOLDER**



TW Surgical

# NEEDLE HOLDER

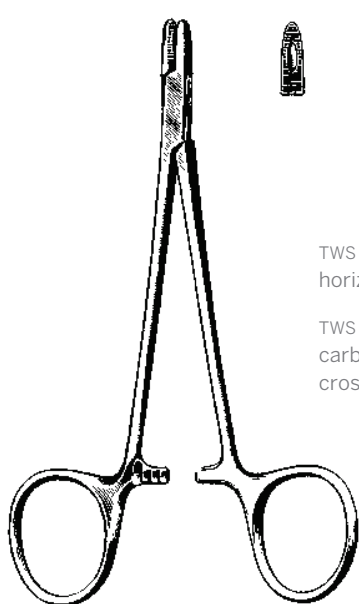

TWS 84-2005/42  
horizontal serrations

TWS 84-2005/43  
carbide  
cross serrations

**DERF NEEDLE HOLDER**  
4 3/4" (121mm)

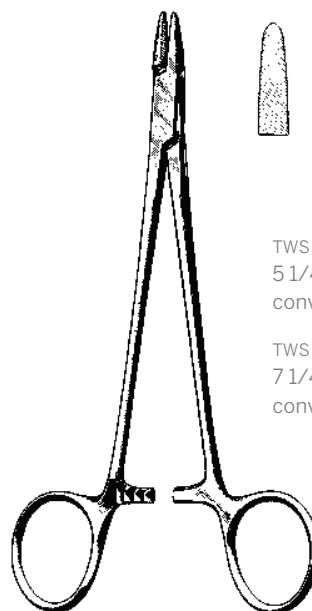

TWS 84-2005/44  
5 1/4" (133mm)  
convex jaws

TWS 84-2005/45  
7 1/4" (184mm)  
convex jaws

**BROWN NEEDLE HOLDER**  
Fine serrations

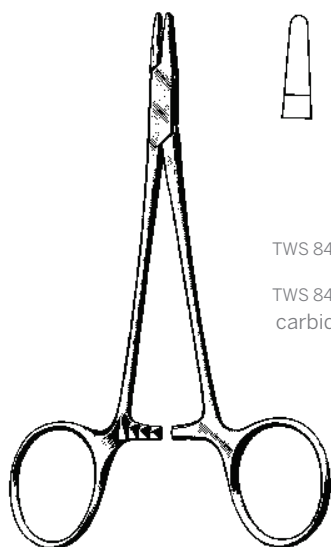

TWS 84-2005/47

TWS 84-2005/48  
carbide

**WEBSTER  
NEEDLE HOLDER**  
5" (127mm) Smooth

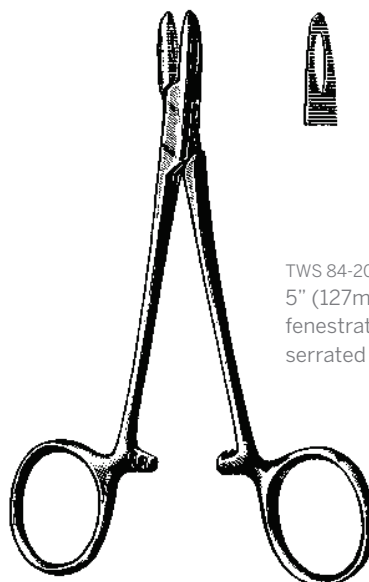

TWS 84-2005/49  
5" (127mm)  
fenestrated jaws  
serrated

**COLLIER  
NEEDLE HOLDER**

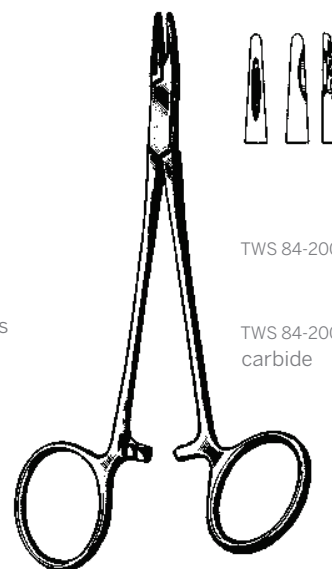

TWS 84-2005/51

TWS 84-2005/52  
carbide

**NIEVERT  
NEEDLE HOLDER**  
5" (127mm) Smooth, one offset finger ring



TW Surgical

## NEEDLE HOLDER

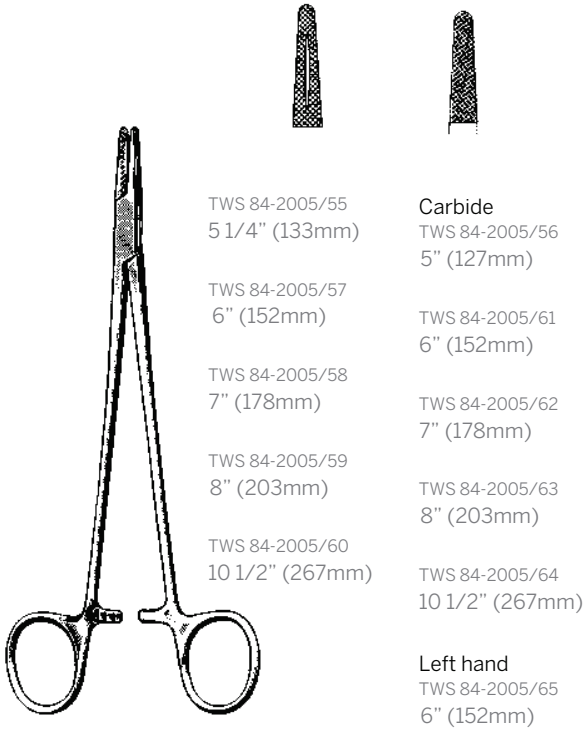

### MAYO HEGAR NEEDLE HOLDER

Serrated

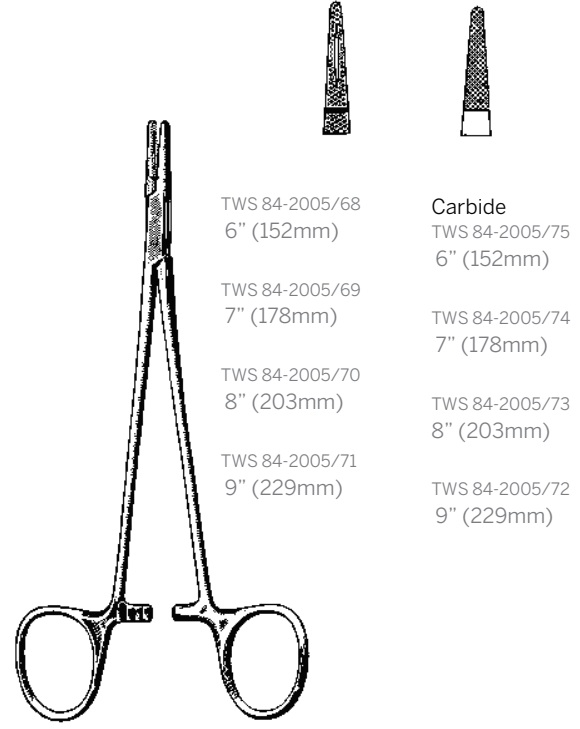

### CRILE-WOOD (DEBAKEY) NEEDLE HOLDER

Serrated

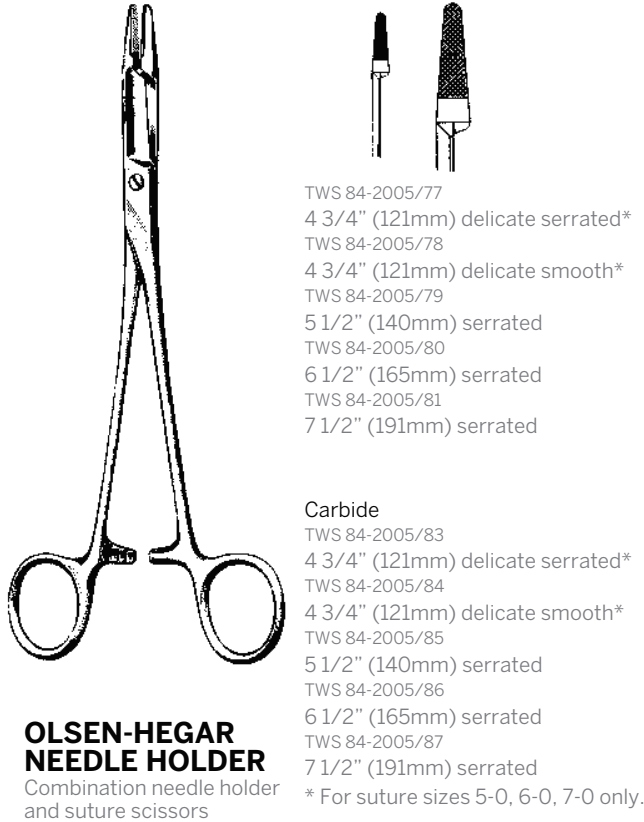

### OLSEN-HEGAR NEEDLE HOLDER

Combination needle holder and suture scissors

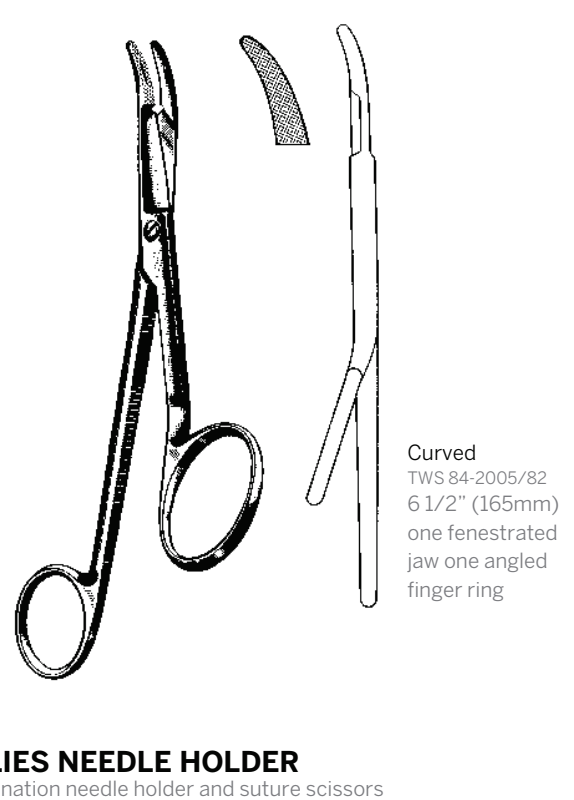

### GILLIES NEEDLE HOLDER

Combination needle holder and suture scissors



TW Surgical

# NEEDLE HOLDER

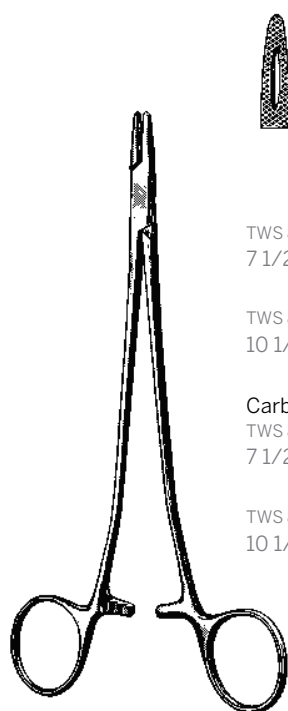

  
 TWS 84-2005/89  
 7 1/2" (191mm)  
 TWS 84-2005/90  
 10 1/2" (267mm)  
 Carbide  
 TWS 84-2005/91  
 7 1/2" (191mm)  
 TWS 84-2005/92  
 10 1/2" (267mm)

**SAROT NEEDLE HOLDER**  
Serrated

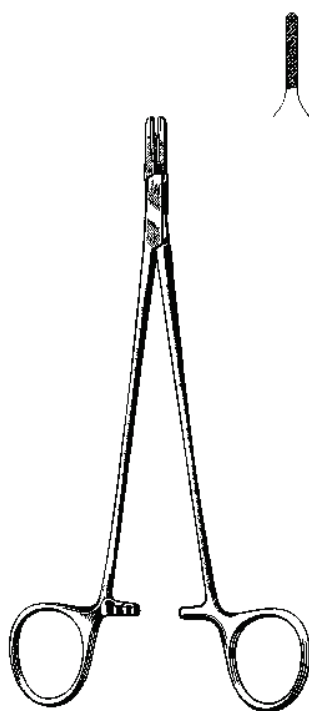

  
 TWS 84-2005/94  
 5" (127mm)  
 TWS 84-2005/95  
 6" (152mm)  
 TWS 84-2005/96  
 7" (178mm)  
 TWS 84-2005/97  
 8" (203mm)  
 TWS 84-2005/98  
 9" (229mm)  
 TWS 84-2005/99  
 10 1/4" (260mm)

**RYDER NEEDLE HOLDER**  
Serrated carbide

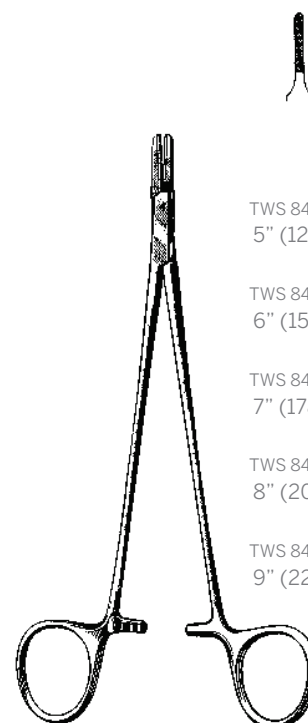

  
 TWS 84-2006/01  
 5" (127mm)  
 TWS 84-2006/02  
 6" (152mm)  
 TWS 84-2006/03  
 7" (178mm)  
 TWS 84-2006/04  
 8" (203mm)  
 TWS 84-2006/05  
 9" (229mm)

**RYDER MICRO NEEDLE HOLDER**  
Serrated carbide

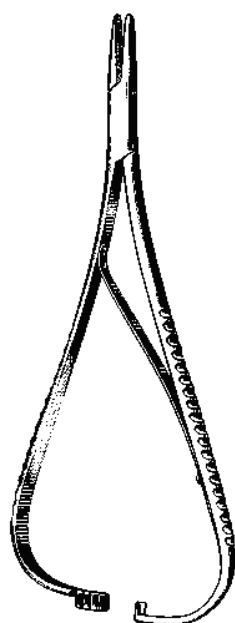

  
 TWS 84-2006/11  
 5 1/2" (140mm)  
 Carbide  
 TWS 84-2006/12  
 5 1/2" (140mm)

**MATHIEU NEEDLE HOLDER**  
Serrated

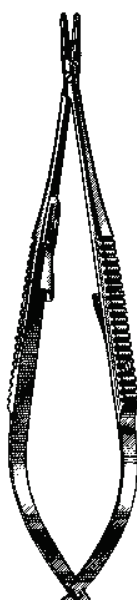

  
 TWS 84-2006/13  
 straight  
 TWS 84-2006/14  
 curved  
 Carbide  
 TWS 84-2006/15  
 straight  
 TWS 84-2006/16  
 curved

**CASTROVIEJO MICRO NEEDLE HOLDER**  
5 1/2" (140mm) smooth, with lock



  
 TWS 84-2006/17  
 straight  
 TWS 84-2006/18  
 curved

**CASTROVIEJO MICRO NEEDLE HOLDER**  
5 1/2" (140mm) extra delicate, smooth, with lock



TW Surgical

## SUCTION TUBES

OAL = Overall Length  
 WL = Working Length  
 FR = French Gauge (1 french = .33mm)

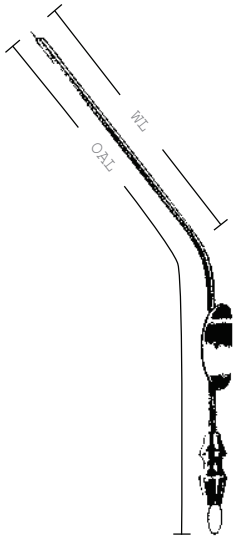

	OAL	FR	WL
TWS 84-2006/19	5 1/2" (140mm)	3	75mm
TWS 84-2006/20	5 1/2" (140mm)	5	75mm
TWS 84-2006/21	5 1/2" (140mm)	7	75mm

**BARON SUCTION TUBE**

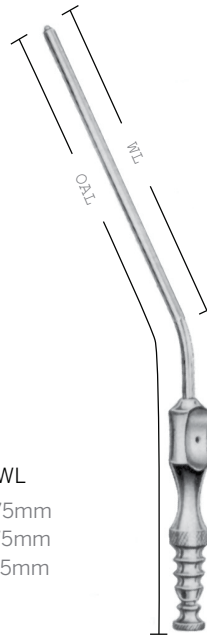

	OAL	FR	WL
TWS 84-2006/22	7" (178mm)	6	90mm
TWS 84-2006/23	7" (178mm)	7	90mm
TWS 84-2006/24	7" (178mm)	8	90mm
TWS 84-2006/25	7" (178mm)	10	90mm
TWS 84-2006/26	7" (178mm)	11	90mm
TWS 84-2006/27	7" (178mm)	12	90mm
TWS 84-2006/28	9" (229mm)	6	130mm
TWS 84-2006/29	9" (229mm)	7	130mm
TWS 84-2006/30	9" (229mm)	8	130mm
TWS 84-2006/31	9" (229mm)	10	130mm
TWS 84-2006/32	9" (229mm)	11	130mm
TWS 84-2006/33	9" (229mm)	12	130mm

**FRAZIER SUCTION TUBE**

Angled 30°

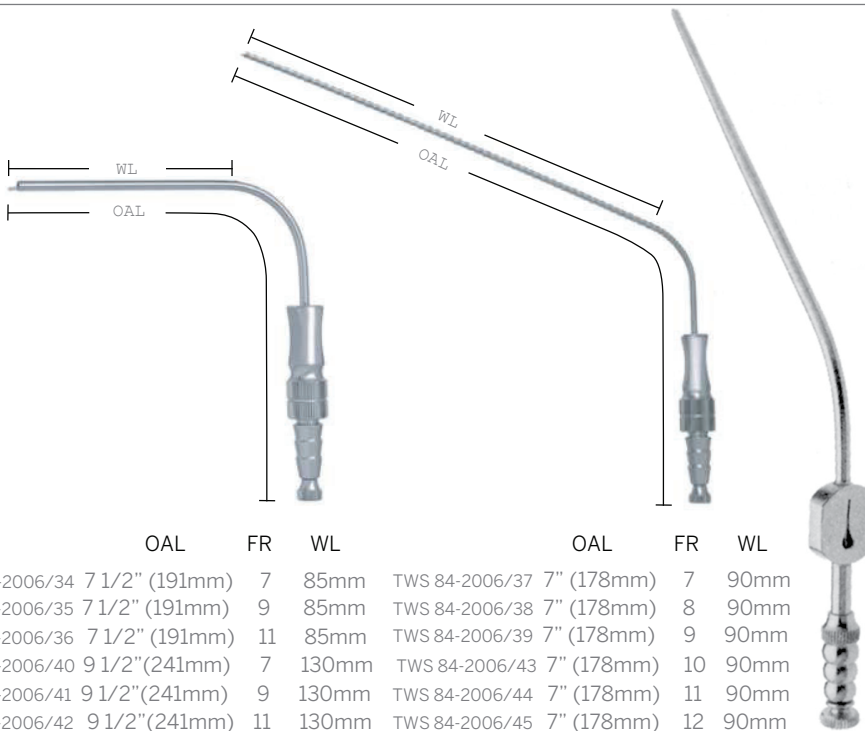

*Tear drop opening allows surgeon to regulate force of suction.*

	OAL	FR	WL		OAL	FR	WL
TWS 84-2006/34	7 1/2" (191mm)	7	85mm	TWS 84-2006/37	7" (178mm)	7	90mm
TWS 84-2006/35	7 1/2" (191mm)	9	85mm	TWS 84-2006/38	7" (178mm)	8	90mm
TWS 84-2006/36	7 1/2" (191mm)	11	85mm	TWS 84-2006/39	7" (178mm)	9	90mm
TWS 84-2006/40	9 1/2" (241mm)	7	130mm	TWS 84-2006/43	7" (178mm)	10	90mm
TWS 84-2006/41	9 1/2" (241mm)	9	130mm	TWS 84-2006/44	7" (178mm)	11	90mm
TWS 84-2006/42	9 1/2" (241mm)	11	130mm	TWS 84-2006/45	7" (178mm)	12	90mm

**FRAZIER SUCTION TUBE**

Angled 90°

**FRAZIER SUCTION TUBE**

Angled 75°

**FUKUSHIMA SUCTION TUBE**

Treasure Wright (U.K.) Ltd.

128-160 City Road, London, EC1V 2NX, United Kingdom  
 info@twrightmedical.com



TW Surgical

# SUCTION TUBES/SCALPEL HANDLES

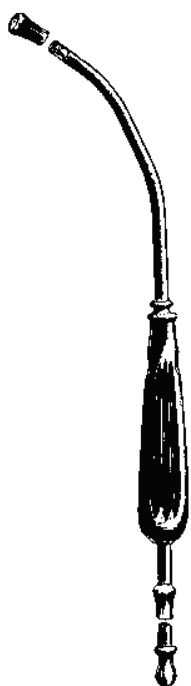

TWS 84-2006/65  
11 1/2" (292mm)  
chrome

TWS 84-2006/66  
front tip only

**YANKAUER SUCTION TUBE**

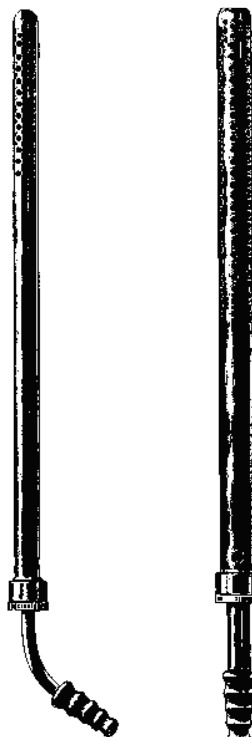

1 french = .33mm

TWS 84-2006/67  
23 french curved

TWS 84-2006/68  
30 french straight

**POOLE SUCTION TUBE**

9" (229mm) Chrome



TWS 84-2006/69  
for blades 61 through 67

**MINI SCALPEL HANDLE  
#3K**



TWS 84-2006/70

**SCALPEL HANDLE MINI  
(BEAVER) #3K 6"**



TWS 84-2006/71

**SCALPEL HANDLE MINI  
(BEAVER) #3K 5"**

Treasure Wright (U.K.) Ltd.

128-160 City Road, London, EC1V 2NX, United Kingdom  
info@twrightmedical.com



TW Surgical

## SCALPEL HANDLES



TWS 84-2006/72  
for blades  
10 through 15

**SCALPEL HANDLE #3**



TWS 84-2006/73  
mm and cm graduations  
for blades 10 through 15

**SCALPEL HANDLE #3**



TWS 84-2006/74  
for blades  
20 through 25

**SCALPEL HANDLE #4**



TWS 84-2006/75  
extra long  
8 1/2" (216mm)  
for blades 10 through 15

**SCALPEL HANDLE #3L**



TWS 84-2006/76  
for blades 10 through 15

**SCALPEL HANDLE #7**



TWS 84-2006/77  
extra fine  
for blades 10 through 15

**SCALPEL HANDLE #9**

**Treasure Wright (U.K.) Ltd.**

128-160 City Road, London, EC1V 2NX, United Kingdom  
info@twrightmedical.com



TW Surgical

# PROBES AND PERCUSSION HAMMER



- TWS 84-2006/78 4 1/2" (114mm)
- TWS 84-2006/79 5" (127mm)
- TWS 84-2006/80 5 1/2" (140mm)
- TWS 84-2006/81 6" (152mm)
- TWS 84-2006/82 8" (203mm)
- TWS 84-2006/83 10" (254mm)
- TWS 84-2006/84 12" (305mm)

## PROBE WITH EYE

Malleable stainless

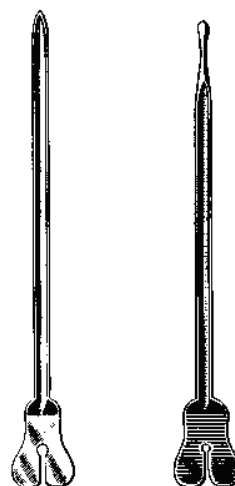

- With tongue tie**
- TWS 84-2006/85 4 1/2" (114mm)
- TWS 84-2006/86 5" (127mm)
- TWS 84-2006/87 5 1/2" (140mm)
- TWS 84-2006/88 6" (152mm)
- With probe and tongue tie**
- TWS 84-2006/89 5" (127mm)
- TWS 84-2006/90 5 1/2" (140mm)
- TWS 84-2006/91 6" (152mm)

## GROOVED DIRECTORS



- TWS 84-2006/92 7" (178mm) small
- TWS 84-2006/93 8" (203mm) large

## TAYLOR PERCUSSION HAMMER

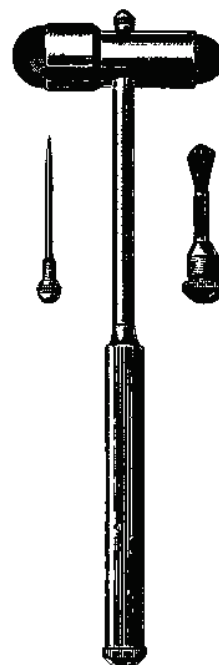

- TWS 84-2006/94 7 3/4" (197mm)
- chrome with brush and needle

## BUCK NEUROLOGICAL HAMMER



TW Surgical

# SUTURE INSTRUMENTS/PASSERS/BIPOLAR INSTRUMENTS

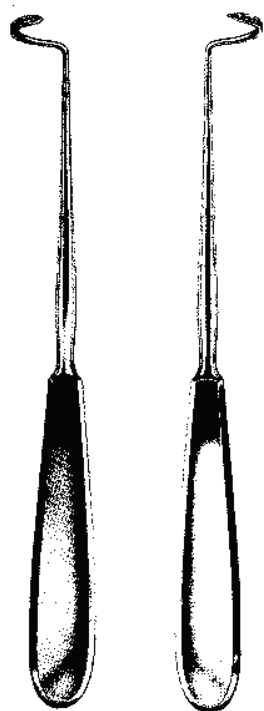

TWS 84-2006/95 blunt left  
TWS 84-2006/96 blunt right  
TWS 84-2006/97 sharp left  
TWS 84-2006/98 sharp right

**DESCHAMPS LIGATURE CARRIER**  
8"(203mm)



TWS 84-2006/99  
0.12mm  
1x2 teeth

TWS 84-2007/00  
0.5mm  
1x2 teeth

**CASTROVIEJO MICRO TYING FORCEPS**  
4"(102mm) Straight with tying platform

*Bipolar forceps  
Available in most styles and tip sizes.*



TWS 84-2007/01  
4"(102mm)  
8mm platform  
0.5mm tip

**JEWELERS FORCEPS**

**Treasure Wright (U.K.) Ltd.**

128-160 City Road, London, EC1V 2NX, United Kingdom  
info@twrightmedical.com



**TW**  
Surgical

## Treasure Wright (U.K.) Ltd.

---

**Address: 128-160 , City Road,  
London EC1V 2NX. United Kingdom**

---

[www.twrightmedical.com](http://www.twrightmedical.com)

[info@twrightmedical.com](mailto:info@twrightmedical.com)



TW Surgical



**UK  
CA CE**