



TW
Surgical

ENT



**UK
CA CE**



TW Surgical

Treasure Wright (U.K.) Ltd.



www.twrightmedical.com



info@twrightmedical.com

Ear Polypus Snares



KRAUSE
TWS 84-3028/41
16 cm - 6¼"



WILDE
TWS 84-3028/42
16 cm - 6¼"



TWS 84-3028/43 Ø 0.2 mm
TWS 84-3028/44 Ø 0.3 mm



TWS 84-3028/45 Ø 0.2 mm
TWS 84-3028/46 Ø 0.3 mm
TWS 84-3028/47 Ø 0.35 mm

Snare wire, coli/10 meters (33.3.ft.)

Snare loops, pre-shaped, bundle/100 pieces

Treasure Wright (U.K.) Ltd.

128-160 City Road, London, EC1V 2NX, United Kingdom
info@twrightmedical.com



TW Surgical

Tuning Forks



TWS 84-3028/48
C-128



TWS 84-3028/49
C¹-256



TWS 84-3028/50
C²-512



TWS 84-3028/51
C³-1024



TWS 84-3028/52
C⁴-2048

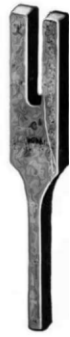

TWS 84-3028/53
C⁵-4096

HARTMANN

ALU Tuning Forks, made of special aluminium alloy



TWS 84-3028/54
C-64



TWS 84-3028/55
C-128



TWS 84-3028/56
C¹-256



TWS 84-3028/57
C²-512



TWS 84-3028/58
C³-1024



TWS 84-3028/59
C⁴-2048



TWS 84-3028/60
C⁵-4096

ALU

Treasure Wright (U.K.) Ltd.

128-160 City Road, London, EC1V 2NX, United Kingdom
info@twrightmedical.com

Tuning Forks



TWS 84-3028/63
C-128

TWS 84-3028/64
C¹-256

TWS 84-3028/65
C²-512

TWS 84-3028/66
C³-1024

TWS 84-3028/61
C⁴-2048

TWS 84-3028/62
C⁵-4096

LUCAE



ALU
TWS 84-3028/67

ALU Set of 5 Tuning Forks,
in case, consisting of:

Treasure Wright (U.K.) Ltd.

128-160 City Road, London, ECLV 2NX, United Kingdom
info@twrightmedical.com

Ear Speculum



TW Surgical

For children



TWS 84-3028/75
HARTMANN

Set/3 sizes (# 1 -3)



TWS 84-3028/68
#1 - Ø 3.0 mm



TWS 84-3028/69
#2 - Ø 4.5 mm



TWS 84-3028/70
#3 - Ø 5.5 mm

For adults



TWS 84-3028/74
HARTMANN

Set/3 sizes (# 1 -3)



TWS 84-3028/71
#1 - Ø 5.5 mm



TWS 84-3028/72
#2 - Ø 6.5 mm



TWS 84-3028/73
#3 - Ø 7.5 mm

For adults



TWS 84-3028/80
BOUCHERON

Set/4 sizes (# 1 - 4)



TWS 84-3028/76
#1 - Ø 4.5 mm



TWS 84-3028/77
#2 - Ø 5.5 mm



TWS 84-3028/78
#3 - Ø 6.5 mm



TWS 84-3028/79
#4 - Ø 7.5 mm



TWS 84-3028/83
#1 - Ø 4.5 mm



TWS 84-3028/84
#2 - Ø 5.5 mm



TWS 84-3028/85
#3 - Ø 6.5 mm



TWS 84-3028/82
#4 - Ø 7.5 mm



GRUBER
TWS 84-3028/81

Set/4 sizes (# 1 - 4)

Treasure Wright (U.K.) Ltd.

128-160 City Road, London, EC1V 2NX, United Kingdom
info@twrightmedical.com



TW Surgical

Ear Speculum

For adults



TWS 84-3028/86
#1 - Ø 4.5 mm

For adults



TWS 84-3028/87
#2 - Ø 5.5 mm



TOYNBEE
TWS 84-3028/90



TWS 84-3028/88
#3 - Ø 6.5 mm



TOYNBEE
TWS 84-3028/91



TWS 84-3028/89
#4 - Ø 7.5 mm

Set/3 sizes (# 2 – 4)

Set/4 sizes (# 1 – 4)



TWS 84-3028/92
Ø 5.5 mm



Ø 3.0 mm
TWS 84-3028/99
Fig. 1



TWS 84-3028/93
Ø 6.5 mm



Ø 4.5 mm
TWS 84-3029/00
Fig. 2



TWS 84-3028/94
Ø 7.5 mm



Ø 5.5 mm
TWS 84-3029/01
Fig. 3



FARRIOR
(BLACK)
TWS 84-3029/03



TWS 84-3028/95
Ø 8.5 mm



Ø 6.5 mm
TWS 84-3029/02
Fig. 4



TWS 84-3028/96
Ø 9.5 mm



POLITZER
TWS 84-3029/04
Set of 3 (Fig. 1,2,3)



TWS 84-3028/97
Ø 10.5 mm

TWS 84-3029/05
Set of 4 (Fig. 1,2,3),4



TWS 84-3028/98
Ø 11.5 mm

Treasure Wright (U.K.) Ltd.

128-160 City Road, London, EC1V 2NX, United Kingdom
info@twrightmedical.com

Ear Speculum



TWS 84-3029/12
ZOELLNER



TWS 84-3029/06
#1 - 5.5 x 6.5 mm



TWS 84-3029/07
#2 - 6.5 x 7.5 mm



TWS 84-3029/08
#3 - 7.5 x 8.5 mm



TWS 84-3029/09
#4 - 8.5 x 9.5 mm



TWS 84-3029/10
#5 - 9.5 x 10.5 mm



TWS 84-3029/11
#6 - 10.5 x 11.5 mm

Set / 6 sizes (# 1 - 6)

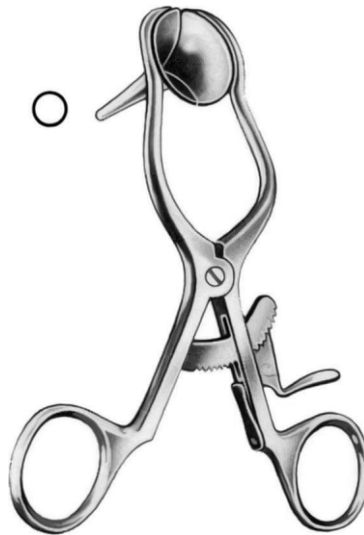

PAPARELLA
TWS 84-3029/13
13 cm - 5¼"

Treasure Wright (U.K.) Ltd.

128-160 City Road, London, EC1V 2NX, United Kingdom
info@twrightmedical.com

Mastoid Rongeurs

Length of shaft 80 mm (3 1/8")

Length of shaft 60 mm (2 3/8")

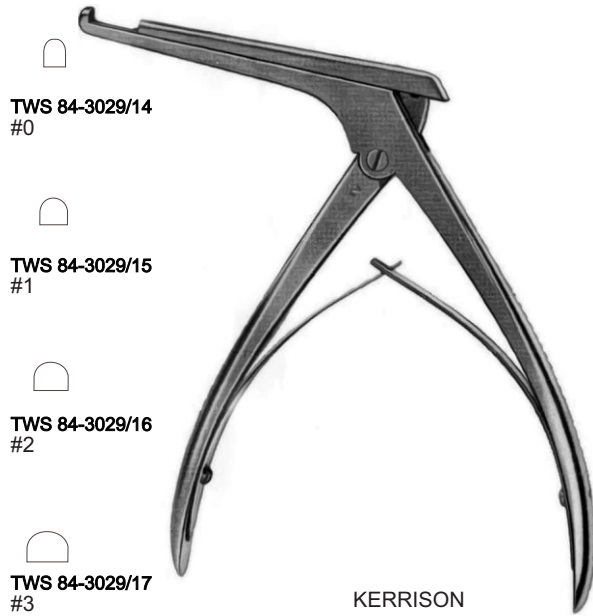

Chisel-edged punch



Atticus punch

TWS 84-3029/21
4 mm

TWS 84-3029/22
6 mm



BRÜNINGS



BEYER
TWS 84-3029/23
2 mm



TW Surgical

Raspatories

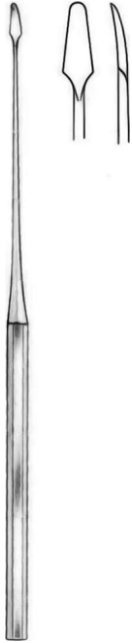

WULLSTEIN
TWS 84-3029/24
17 cm - 6³/₄"

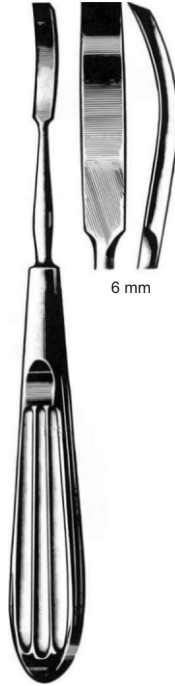

LEMPERT
TWS 84-3029/25
18 cm - 7¹/₄"



LEMPERT
TWS 84-3029/26
20 cm - 8"



JANSEN
TWS 84-3029/27
17 cm - 6³/₄"



VOSS
TWS 84-3029/28
15 cm - 6"

Treasure Wright (U.K.) Ltd.

128-160 City Road, London, EC1V 2NX, United Kingdom
info@twrightmedical.com

Periosteotomes, Elevators



Periosteal Knife

Mastoid Knife



MUCK
TWS 84-3029/29
13 cm - 5 $\frac{1}{8}$ "



POLITZER
TWS 84-3029/30
13 cm - 5 $\frac{1}{8}$ "



LEMPERT
18 cm - 7 $\frac{1}{8}$ "



TWS 84-3029/31
2 mm



TWS 84-3029/33
3 mm



TWS 84-3029/32
4 mm

Ear Catheters



HARTMANN
14 cm - 5½"



TWS 84-3029/34
1 - Ø 2.5 mm



TWS 84-3029/35
2 - Ø 3 mm



TWS 84-3029/36
3 - Ø 3.5 mm



TWS 84-3029/37
4 - Ø 4 mm



TWS 84-3029/38
5 - Ø 5 mm



Graduated

TROELTSCH
14 cm - 5½"



TWS 84-3029/39
1 - Ø 2.5 mm



TWS 84-3029/41
2 - Ø 3 mm



TWS 84-3029/42
3 - Ø 3.5 mm



TWS 84-3029/40
4 - Ø 4 mm



TWS 84-3029/43
5 - Ø 5 mm



Olive-shaped tube connector for Hartmann and troeltsch ear catheters

TWS 84-3029/44

Treasure Wright (U.K.) Ltd.

128-160 City Road, London, EC1V 2NX, United Kingdom
info@twrightmedical.com



TW Surgical

Aspirating and irrigating instruments

WULLSTEIN irrigating suction
Handle, with Luer cone,
For WULLSTEIN irrigating or suction tubes



WULLSTEIN TWS 84-3029/45

#1 ●
#2 ●

Working length 110mm-4 3/8"



FRAZIER (FERGUSON)
TWS 84-3029/46 #1-Ø 1.00 mm X 190 mm
TWS 84-3029/47 #2-Ø 2.00 mm X 190 mm

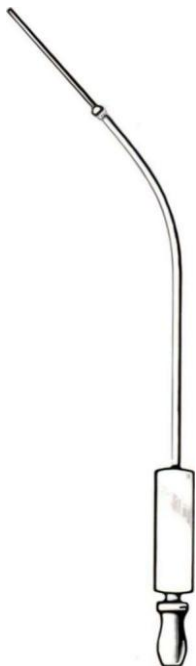

Aspirating tube only
(Without cannula)

TWS 84-3029/50



ZÖLLNER
TWS 84-3029/48 Ø 0.5mm
TWS 84-3029/49 Ø 0.7mm

Micro Suction Cannula only,
for Suction Tube, working length 30 mm

Aspirating and irrigating instruments



HOUSE
TWS 84-3029/51 # 1 - Ø 0.9 + 0.7 mm
TWS 84-3029/52 # 2 - Ø 1.2 + 0.9 mm
TWS 84-3029/53 # 3 - Ø 1.5 + 1.2 mm

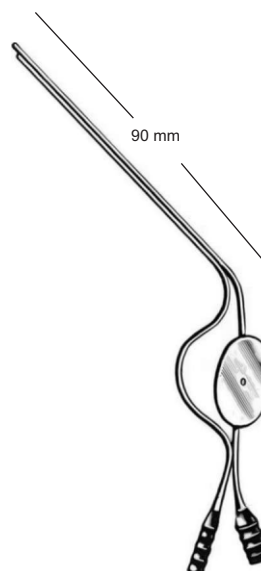

TWS 84-3029/52 # 1 - Ø 1.8 + 1.8 mm
TWS 84-3029/53 # 2 - Ø 2.5 + 2.0 mm
TWS 84-3029/54 # 3 - Ø 3.0 + 2.0 mm
TWS 84-3029/55 # 4 - Ø 4.5 + 2.0 mm

For the right ear

For the left ear



HARTMANN
TWS 84-3029/56
 #1

HARTMANN
TWS 84-3029/57
 #2



TW Surgical

Aspirating and irrigating instruments

with LUER-LOCK attachment



ROSEN
TWS 84-3029/58 Ø 0.70 x 80 mm
TWS 84-3029/59 Ø 0.90 x 80 mm
TWS 84-3029/60 Ø 1.20 x 80 mm

with LUER-LOCK attachment

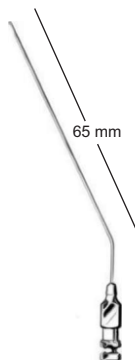

ROSEN
TWS 84-3029/61 Ø 0.70 x 65 mm
TWS 84-3029/62 Ø 0.90 x 65 mm
TWS 84-3029/63 Ø 1.20 x 65 mm
TWS 84-3029/64 Ø 1.50 x 65 mm
TWS 84-3029/65 Ø 2.00 x 65 mm

with finger cut-off



BARON (SCHUKNECHT)
TWS 84-3029/66 Ø 1.0 x 75 mm
TWS 84-3029/67 Ø 1.5 x 75 mm
TWS 84-3029/68 Ø 2.0 x 75 mm



Flexible

With luer cone

Sterling silver

WULLSTEIN
TWS 84-3029/70 Ø 1.5 mm
TWS 84-3029/71 Ø 2.0 mm
 16 cm - 6¼"



WULLSTEIN
TWS 84-3029/72
 16 cm - 6¼" Ø 1.5 mm



TWS 84-3029/69

Tube connector, with luer cone and cut-off plate, for WULLSTEIN and ROSEN suction tubes

Treasure Wright (U.K.) Ltd.

128-160 City Road, London, EC1V 2NX, United Kingdom
 info@twrightmedical.com

Ear Syringes

TWS 84-3029/73



TWS 84-3029/75

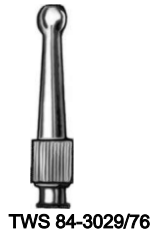

TWS 84-3029/76

All metal ear syringe, complete with 2 attachments and 1 protecting plate, with LUER LOCK attachment

LUER-LOCK
TWS 84-3029/77 50 ml
TWS 84-3029/78 75 ml
TWS 84-3029/79 100 ml

TWS 84-3029/80

Conical attachment only,
With luer-lock cone

TWS 84-3029/81

Olive-shaped attachment only,
With luer-lock cone

TWS 84-3029/82















Protective plate only, Ø 58 mm,
With luer-lock cone

Treasure Wright (U.K.) Ltd.

Ear Currettes

















BUCK
15 cm-6"

sharp		blunt	
			
TWS 84-3029/83 # 00 - Ø 1.5 mm	TWS 84-3029/84 # 2 - Ø 2.7 mm	TWS 84-3029/60 # 00 - Ø 1.5 mm	TWS 84-3029/61 # 2 - Ø 2.7 mm
			
TWS 84-3029/85 # 0 - Ø 1.9 mm	TWS 84-3029/86 # 3 - Ø 3.4 mm	TWS 84-3029/62 # 0 - Ø 1.9 mm	TWS 84-3029/63 # 3 - Ø 3.4 mm
			
TWS 84-3029/87 # 1 - Ø 2.5 mm	TWS 84-3029/88 # 4 - Ø 4.0 mm	TWS 84-3029/64 # 1 - Ø 2.5 mm	TWS 84-3029/65 # 4 - Ø 4.0 mm
			
	TWS 84-3029/89 # 5 - Ø 4.5 mm		TWS 84-3029/66 # 5 - Ø 4.5 mm

Ø = Inside diameter



BUCK
15 cm-6"

sharp		blunt	
			
TWS 84-3029/67 # 00 - Ø 1.5 mm	TWS 84-3029/68 # 2 - Ø 2.7 mm	TWS 84-3029/75 # 00 - Ø 1.5 mm	TWS 84-3029/78 # 2 - Ø 2.7 mm
			
TWS 84-3029/69 # 0 - Ø 1.9 mm	TWS 84-3029/70 # 3 - Ø 3.4 mm	TWS 84-3029/76 # 0 - Ø 1.9 mm	TWS 84-3029/79 # 3 - Ø 3.4 mm
			
TWS 84-3029/71 # 1 - Ø 2.5 mm	TWS 84-3029/72 # 4 - Ø 4.0 mm	TWS 84-3029/77 # 1 - Ø 2.5 mm	TWS 84-3029/80 # 4 - Ø 4.0 mm
			
	TWS 84-3029/73 # 5 - Ø 4.5 mm		TWS 84-3029/74 # 5 - Ø 4.5 mm

Treasure Wright (U.K.) Ltd.

128-160 City Road, London, EC1V 2NX, United Kingdom
info@twrightmedical.com













TW Surgical

Ear Curettes



BUCK-WULLSTEIN
MICRO
16 cm-6¼"

sharp		blunt	
 TWS 84-3029/81 # 0000 Ø 0.9 mm	 TWS 84-3029/82 # 0 Ø 1.8 mm	 TWS 84-3029/86 # 0000 Ø 0.9 mm	 TWS 84-3029/87 # 0 Ø 1.8 mm
 TWS 84-3029/83 # 000 Ø 1.1 mm	 TWS 84-3029/84 # 1 Ø 2.1 mm	 TWS 84-3029/88 # 000 Ø 1.1 mm	 TWS 84-3029/89 # 1 Ø 2.1 mm
 TWS 84-3029/85 # 00 Ø 1.3 mm		 TWS 84-3029/90 # 00 Ø 1.3 mm	







ø = Inside diameter



BILLEAU
15.5 cm-6¼"



BILLEAU-MICRO
16 cm-6¼"

 TWS 84-3029/91 # 1	 TWS 84-3029/92 # 2	 TWS 84-3029/94 # 00 - 2.0 mm	 TWS 84-3029/95 # 0 - 2.5 mm
 TWS 84-3029/93 # 3		 TWS 84-3029/96 # 1 - 3.0 mm	

Treasure Wright (U.K.) Ltd.

128-160 City Road, London, EC1V 2NX, United Kingdom
 info@twrightmedical.com

Ear Hooks

Ear curette and hook



GROSS
TWS 84-3029/99
12 cm - 4¾"



JANSEN
15 cm - 6"

Ear spoon and hook



GROSS
TWS 84-3030/00
12 cm - 4¾"



ALLPORT
TWS 84-3030/01
16 cm - 6¼"

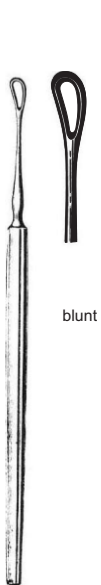

LANGENBECK
TWS 84-3030/05
13.5 cm - 5¾"

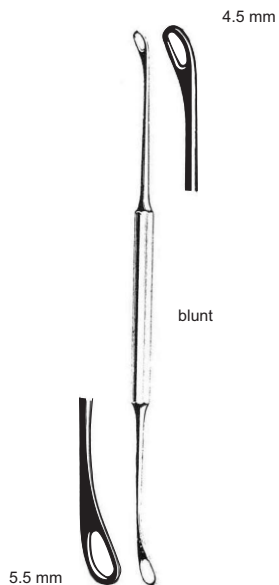

COXETER
TWS 84-3030/06
14.5 cm - 5¾"



WEBER-LOCH
15 cm - 6"



TWS 84-3030/02
0



TWS 84-3030/03
1



TWS 84-3030/04
2

Serrated



TW Surgical

Curettes auriculaires



SHAPLEIGH
14 cm - 5½"



TWS 84-3030/07
1



TWS 84-3030/08
2



TWS 84-3030/09
3



TWS 84-3030/10
4

Serrated



MOLDENHAUER
TWS 84-3030/16
16 cm - 6¼"



ZAUFAL
TWS 84-3030/17
16 cm - 6¼"



WAGENER
14 cm - 5½"



TWS 84-3030/11
4.0 mm



TWS 84-3030/13
3.5 mm



TWS 84-3030/15
3.0 mm



TWS 84-3030/12
2.5 mm



TWS 84-3030/14
2.0 mm

Treasure Wright (U.K.) Ltd.

128-160 City Road, London, EC1V 2NX, United Kingdom
info@twrightmedical.com

Ear Levers



WAGENER
14 cm - 5½"



TWS 84-3030/18
sharp



TWS 84-3030/19
blunt

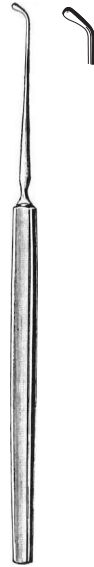

YANKAUER-JANSEN
TWS 84-3030/22
45°, 15 cm - 6"



HARTMANN
16 cm - 6¼"



TWS 84-3030/20
#1



TWS 84-3030/21
#2



LUCAE
14 cm - 5½"



TWS 84-3030/25
Fig. 1



TWS 84-3030/26
Fig. 2



TWS 84-3030/27
Fig. 3



DAY
16 cm - 6¼"



TWS 84-3030/23



TWS 84-3030/24

Sickle Shaped Knives Lancets

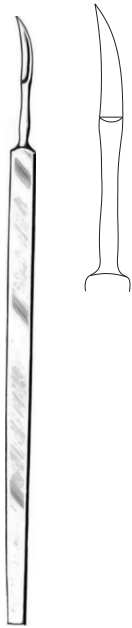

LEMPERT
TWS 84-3030/28
16cm - 6³/₄"

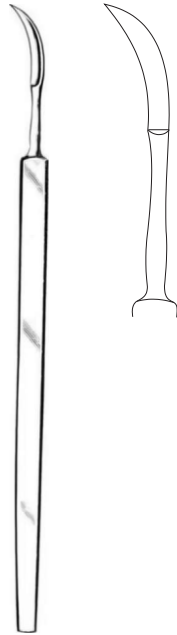

LEMPERT
SI-82.17
17cm - 6³/₄"

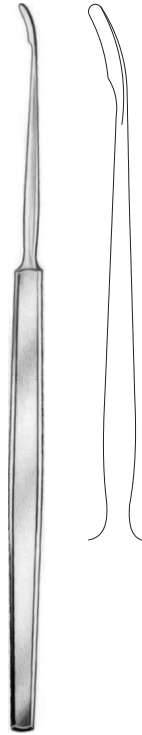

TWS 84-3030/34
19cm - 7¹/₂"

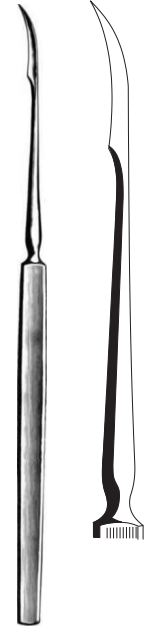

POLITZER
TWS 84-3030/35
16cm - 6³/₄"

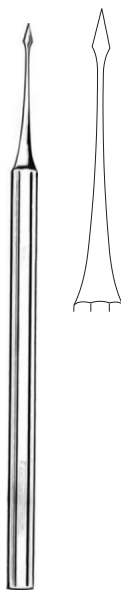

LEMPERT
TWS 84-3030/29
15cm - 6"

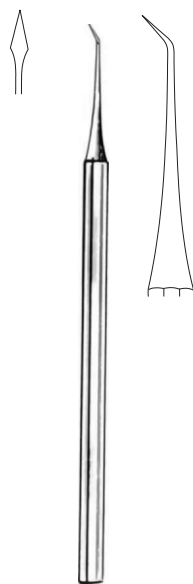

LEMPERT
TWS 84-3030/30
45°, 15cm - 6"

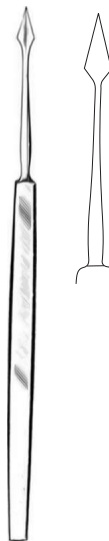

LEMPERT
TWS 84-3030/31
14cm - 5¹/₂"

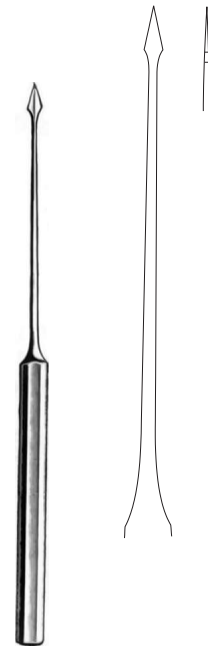

BUCK
TWS 84-3030/32
15cm - 6"



TW Surgical

Tympanum Knives



SEXTON
TWS 84-3030/33
18cm - 7 1/4"

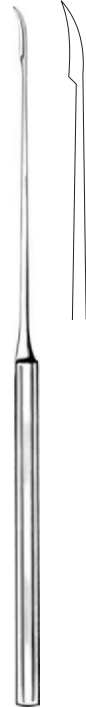

SEXTON
TWS 84-3030/34
18cm - 7 1/4"



SEXTON
TWS 84-3030/35
18cm - 7 1/4"

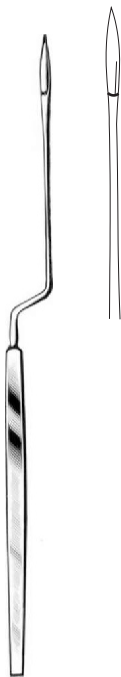

SEXTON
TWS 84-3030/36
18cm - 7 1/4"

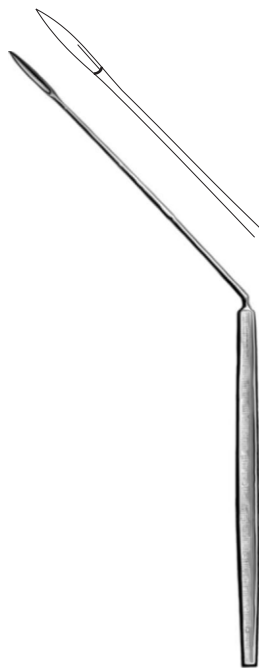

SEXTON
TWS 84-3030/37
18cm - 7 1/4"



with screw-locking handle

SEXTON
TWS 84-3030/38
16cm - 6 1/4"

Treasure Wright (U.K.) Ltd.

128-160 City Road, London, EC1V 2NX, United Kingdom
info@twrightmedical.com

Tympanum Perforators



for adults

LUCAE (ROYCE)
TWS 84-3030/39
18cm - 7 1/4"



for children

LUCAE (ROYCE)
TWS 84-3030/40
18cm - 7 1/4"



POLITZER (ROYCE)
TWS 84-3030/41
16cm - 6 1/4"



POLITZER
TWS 84-3030/42
16cm - 6 1/4"



with screw-locking handle

POLITZER
TWS 84-3030/43
15cm - 6"



LUCAEZ
TWS 84-3030/44
19cm - 7 1/2"

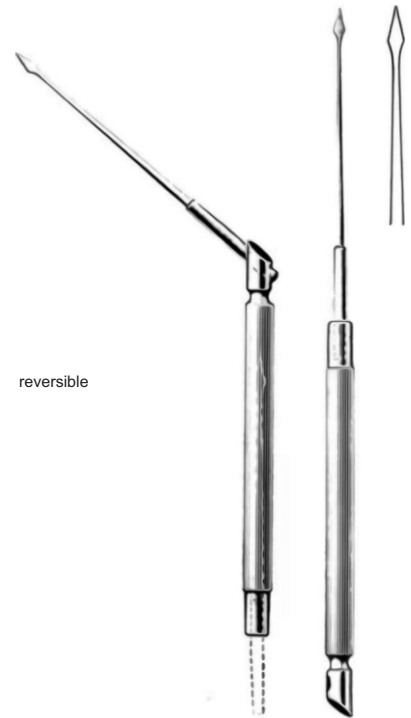

reversible

POLITZER
TWS 84-3030/45
19cm - 7 1/2"

Treasure Wright (U.K.) Ltd.

128-160 City Road, London, EC1V 2NX, United Kingdom
info@twrightmedical.com



TW Surgical

Ear Instrument sets

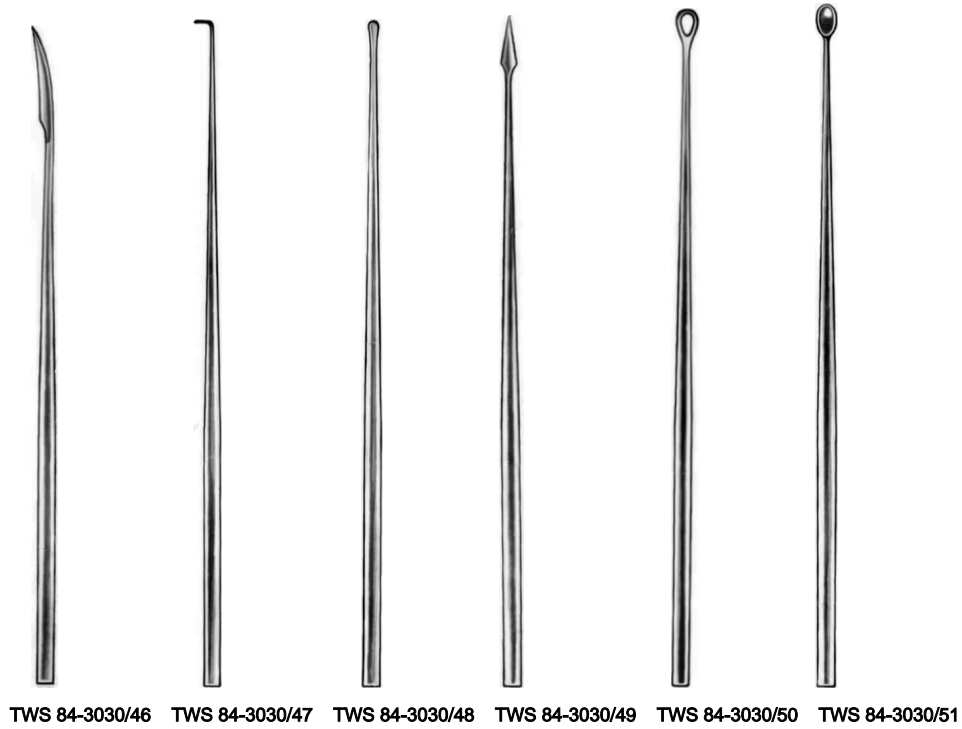

TWS 84-3030/46 TWS 84-3030/47 TWS 84-3030/48 TWS 84-3030/49 TWS 84-3030/50 TWS 84-3030/51

TWS 84-3030/52
SPRAGUE

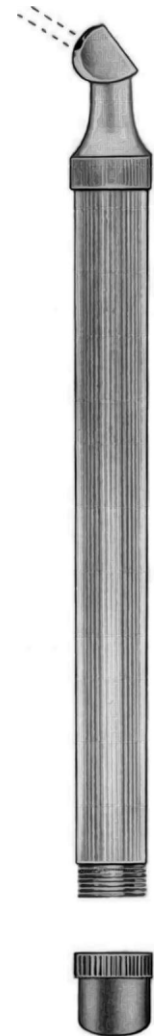

SPRAGUE Ear Instrument set, complete, composed of: 1 Tubular handle with 6 inter.changeable Attachments: 1 sickle-shaped knife 1 blunt-tipped hook, no. **TWS 84-3030/57**: 1 button-tipped probe no. **TWS 84-3030/55**: 1 Tympanum perforating lancet no. **TWS 84-3030/56**

Treasure Wright (U.K.) Ltd.

128-160 City Road, London, EC1V 2NX, United Kingdom
info@twrightmedical.com

Ear Instrument sets

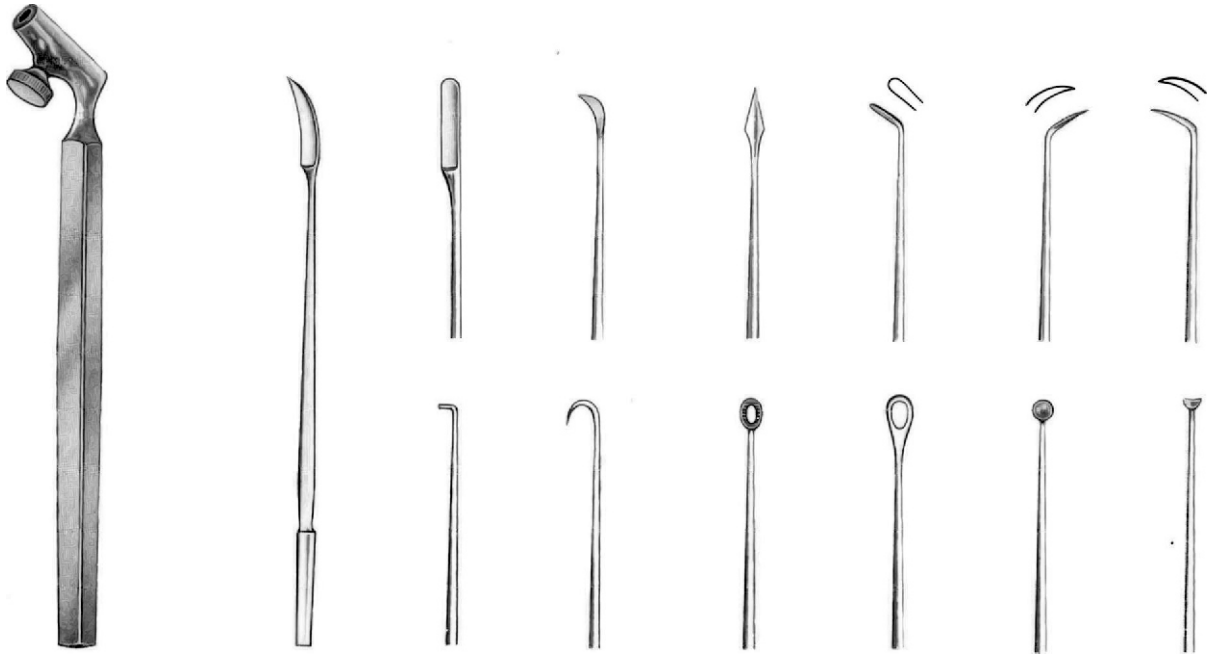

**HARTMANN
TWS 84-3030/58**

HARTMANN ear instrument set, complete, consisting of: 1 handle and 13 interchangeable attachments, in metal case



TW Surgical

Ear Forceps

Foreign body forceps

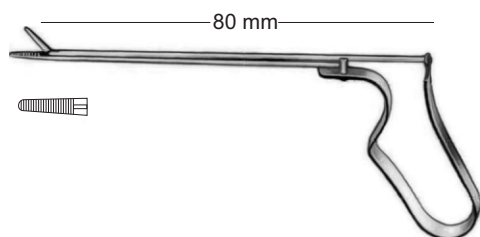

BUCK
TWS 84-3030/59
13 cm - 5¼"

Foreign body lever

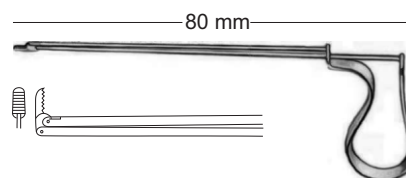

QUIRE
TWS 84-3030/60
10 cm - 4"

Ear Dressing Forceps

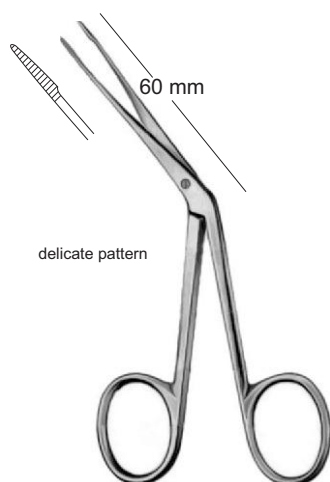

HARTMANN
TWS 84-3030/61
13.5 cm - 5¼"

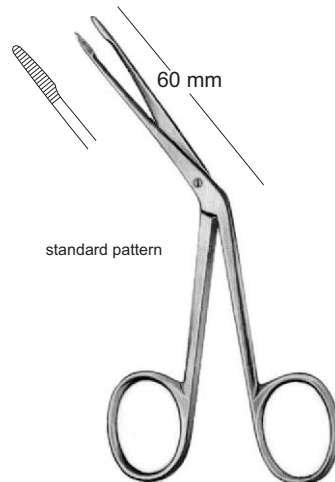

HARTMANN
TWS 84-3030/62
13.5 cm - 5¼"

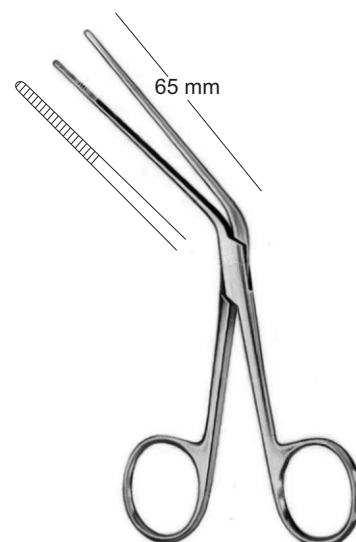

TILLEY
TWS 84-3030/63
14 cm - 5½"

Treasure Wright (U.K.) Ltd.

128-160 City Road, London, EC1V 2NX, United Kingdom
info@twrightmedical.com



TW Surgical

Ear Forceps

medium fine



HARTMANN
TWS 84-3030/64
14 cm - 5½"
serrated jaws



HARTMANN
TWS 84-3030/65
14 cm - 5½"
serrated jaws



HARTMANN
TWS 84-3030/66
14 cm - 5½"
smooth jaws



HARTMANN
TWS 84-3030/67
14 cm - 5½"
smooth jaws, 1 x 2 teeth

heavy pattern



BELLUCCI
TWS 84-3030/68

Grasping Forceps, may also be used as Prosthesis applying forceps or as wire bending forceps.

Treasure Wright (U.K.) Ltd.

128-160 City Road, London, EC1V 2NX, United Kingdom
info@twrightmedical.com

Ear Forceps



HARTMANN
TWS 84-3030/69
14 cm - 5½"

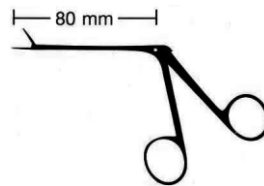

HARTMANN
TWS 84-3030/70
20 cm - 8"

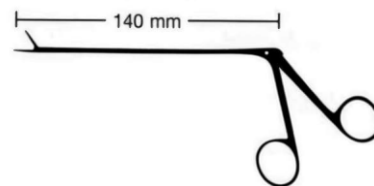

HARTMANN
TWS 84-3030/71
22 cm - 8¾"

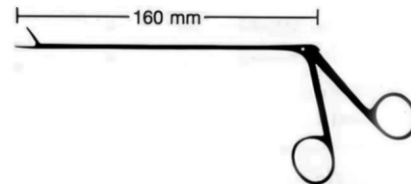



TW Surgical

Ear Forceps

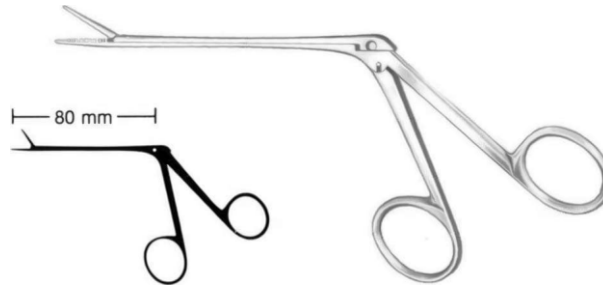

HARTMANN-NOYES
TWS 84-3030/72
14 cm - 5½"



TWS 84-3030/83
14 cm - 5½"
"Duckbill"



HARTMANN
TWS 84-3030/73
14 cm - 5½"
1 X 2 Teeth



WEINGÄRTNER
TWS 84-3030/82
14 cm - 5½"



HARTMANN-HERZFELD
TWS 84-3030/74 Ø 2 mm
TWS 84-3030/75 Ø 2.2 mm
TWS 84-3030/76 Ø 2.5 mm
TWS 84-3030/77 Ø 3 mm
14 cm - 5½"



HARTMANN-HERZFELD
TWS 84-3030/78 Ø 2 mm
TWS 84-3030/79 Ø 2.2 mm
TWS 84-3030/80 Ø 2.5 mm
TWS 84-3030/81 Ø 3 mm
14 cm - 5½"

Treasure Wright (U.K.) Ltd.

128-160 City Road, London, EC1V 2NX, United Kingdom
info@twrightmedical.com

Ear Forceps

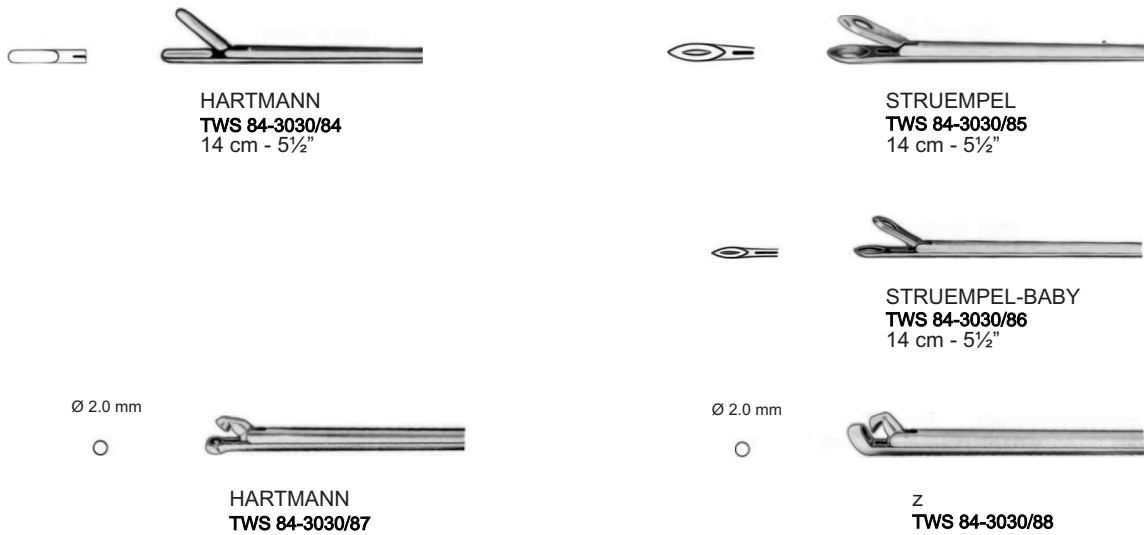
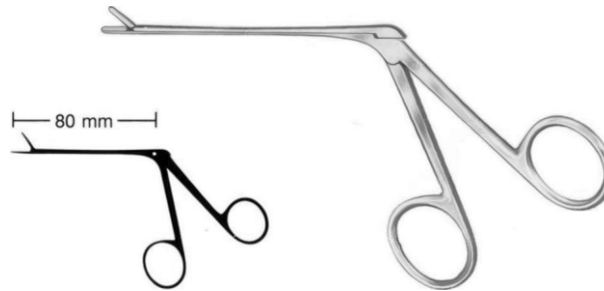

Delicate

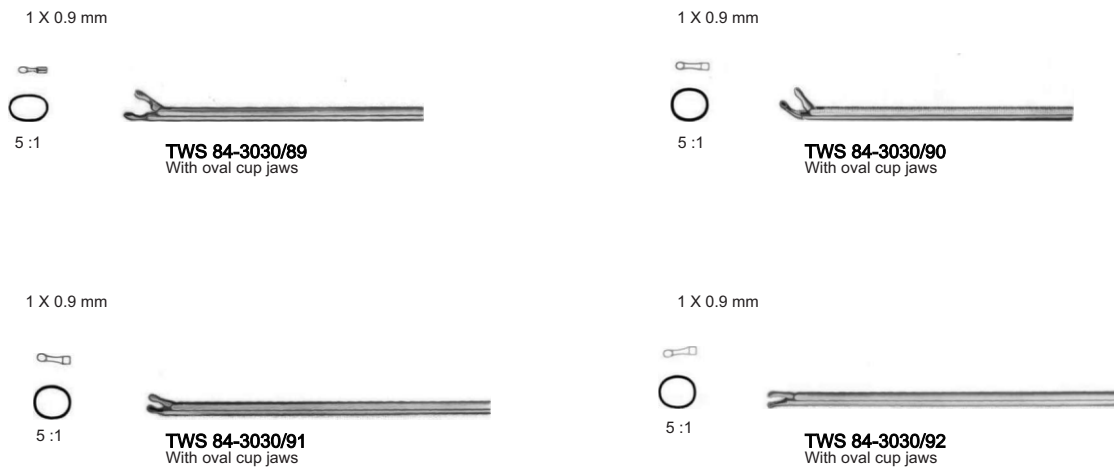



TW Surgical

Ear Forceps

extremely delicate



dismantable shaft

4 X 0.5 mm



3 : 1



TWS 84-3030/93
smooth jaws

4 X 0.5 mm

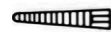

3 : 1



TWS 84-3030/94
serrated jaws

3 X 0.5 mm



3 : 1



TWS 84-3030/95
serrated jaws

3 X 0.5 mm



3 : 1



TWS 84-3030/96
serrated jaws

3 X 0.5 mm

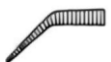

3 : 1



TWS 84-3030/97
serrated jaws

7 X 0.5 mm



3 : 1



TWS 84-3030/98
serrated jaws

4 X 0.4 mm



3 : 1



TWS 84-3030/99
serrated jaws

4 X 0.4 mm



3 : 1



TWS 84-3031/00
serrated jaws

0.6 X 0.5 mm



10 : 1



TWS 84-3031/01
with oval cup jaws

0.6 X 0.5 mm



10 : 1



TWS 84-3031/03
with oval cup jaws

0.6 X 0.5 mm



10 : 1



TWS 84-3031/02
with oval cup jaws

0.6 X 0.5 mm



10 : 1



TWS 84-3031/04
with oval cup jaws

Treasure Wright (U.K.) Ltd.

128-160 City Road, London, EC1V 2NX, United Kingdom
info@twrightmedical.com

Ear Forceps

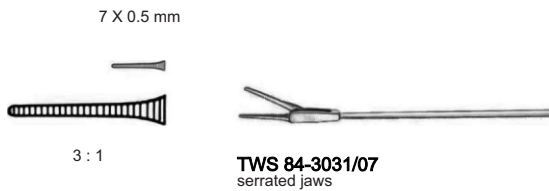
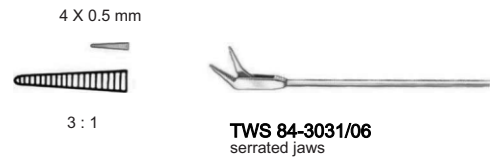

Ear scissors



TW Surgical

delicate

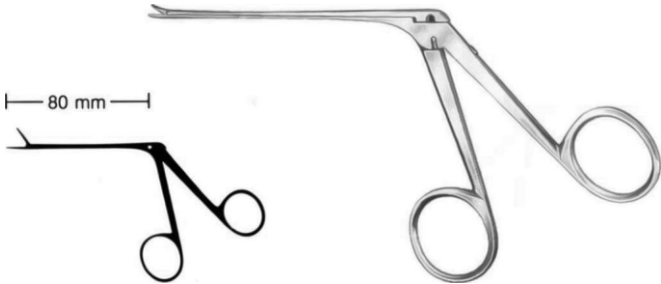

BELLUCCI
TWS 84-3031/11
Sharp/blunt tip, straight



BELLUCCI
TWS 84-3031/12
sharp-tipped blades, straight



BELLUCCI
TWS 84-3031/13
sharp tips, angled up

cutting blades 4 mm long



BELLUCCI
TWS 84-3031/14
Sharp tips, curved right

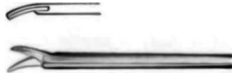

BELLUCCI
TWS 84-3031/15
sharp tips, curved left



TW Surgical

Ear scissors

delicate

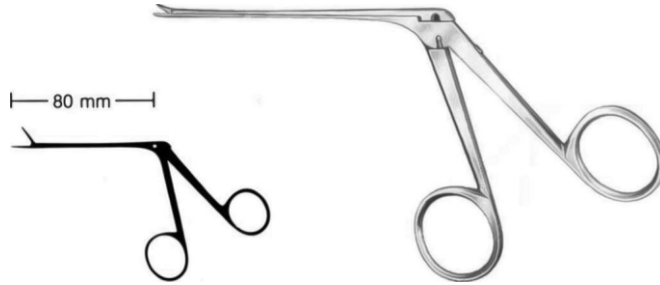

cutting blades 8mm long



SHEA-BELLUCCI
TWS 84-3031/16
sharp-tipped blades, straight



SHEA-BELLUCCI
TWS 84-3031/17
Sharp-tipped blades, straight



SHEA-BELLUCCI
TWS 84-3031/18
semisharp tips, curved right

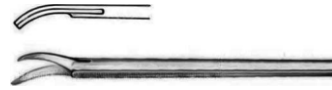

SHEA-BELLUCCI
TWS 84-3031/19
semisharp tips, curved left

Treasure Wright (U.K.) Ltd.

128-160 City Road, London, EC1V 2NX, United Kingdom
info@twrightmedical.com

Tesouras auriculares

delicate

with tubular shaft



Cutting blades 4mm long



TWS 84-3031/20
sharp-tipped blades, straight

TWS 84-3031/21
sharp tips, angled up

TWS 84-3031/22
sharp tips, curved right

TWS 84-3031/23
sharp tips, curved left

Wire Bending Forceps

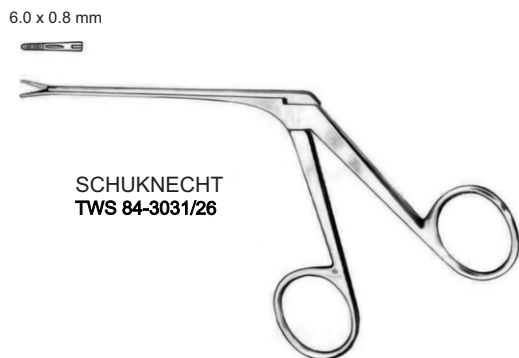
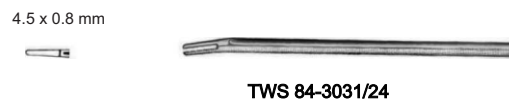
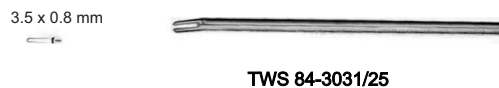
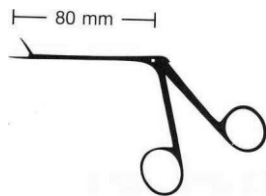

Wire crimper for closing wire loop of prostheses
After attachment to incus or malleus.
A groove in the rear part of the crimper jaws
Prevents the wire loop from crushing when closing
The forceps. Jaws slightly curved downwards

Wire bending forceps, for application of Teflon-wire prostheses.
Jaws slightly curved downwards.



TW Surgical

Punches, Malleus Nippers

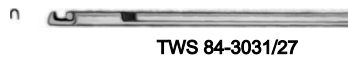
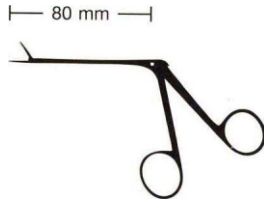

TWS 84-3031/27



TWS 84-3031/29



TWS 84-3031/28



TWS 84-3031/30



DAVOL
TWS 84-3031/31



DIETER

Rongeur forceps for removing the bony Posterior canal wall for better access to incus and stapes.

Malleus punch, chisel-edge, 1.3mm wide

TWS 84-3031/35
nach oben schneidend, up cutting,

TWS 84-3031/33
nach unten schneidend, down cutting

TWS 84-3031/32
nach rechts schneidend, right cutting,

TWS 84-3031/34
nach links schneidend, left cutting,

Treasure Wright (U.K.) Ltd.

128-160 City Road, London, EC1V 2NX, United Kingdom
info@twrightmedical.com

Grasping Forceps

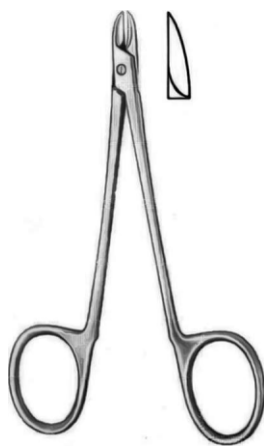

LEMPERT
TWS 84-3031/36
11.5 cm - 4½"

Malleus forceps



WULLSTEIN
TWS 84-3031/37
15 cm - 6"

Malleus nipper,
Chisel edge 3 mm long,
Length of shaft 80mm (3½")



TW Surgical

Grasping Forceps



FULLER
TWS 84-3031/39

Forceps for holding and inserting stapedial prostheses of Teflon, Plain jaws 6 x 0.8mm, length of shaft 75mm (3")



GREVEN
TWS 84-3031/38

Grasping forceps for the removal of otosclerotic proliferations (also, suitable for inserting Prostheses into the inner ear and for setting Drainage buttons), front part of jaws serrated, 3 x 1 mm, length of shaft 70 mm (2 ¾)



TABB
TWS 84-3031/40

Tabb crura nipper, alligator type, for crurotomy And removal of footplate fragments in the oval Window area, width of shaft 1.5mm, usable length of shaft 65 mm

Treasure Wright (U.K.) Ltd.

128-160 City Road, London, EC1V 2NX, United Kingdom
info@twrightmedical.com



TW Surgical

Knives for Otology

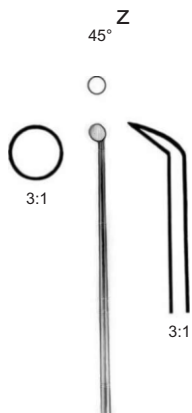

ANTOLI-CANDELA
TWS 84-3031/41 Ø 1.0 mm
TWS 84-3031/42 Ø 1.5 mm
TWS 84-3031/43 Ø 2.0 mm
TWS 84-3031/44 Ø 2.3 mm
TWS 84-3031/45 Ø 2.5 mm

Incision Knife

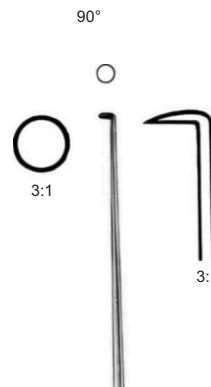

TWS 84-3031/46 Ø 1.0 mm
TWS 84-3031/47 Ø 1.5 mm
TWS 84-3031/48 Ø 2.0 mm
TWS 84-3031/49 Ø 2.3 mm
TWS 84-3031/50 Ø 2.5 mm

Circular cutting knife

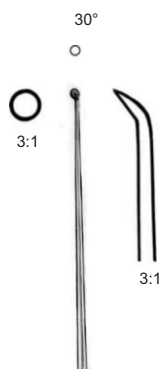

HOUSE
TWS 84-3031/51
 Ø 1.0 mm

Round knife for incudo-stapedial joint

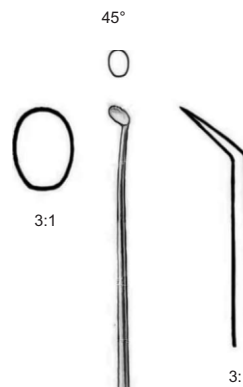

GOLDMANN
TWS 84-3031/52
 Ø 3.0 mm

Knife-elevator for meatal wall

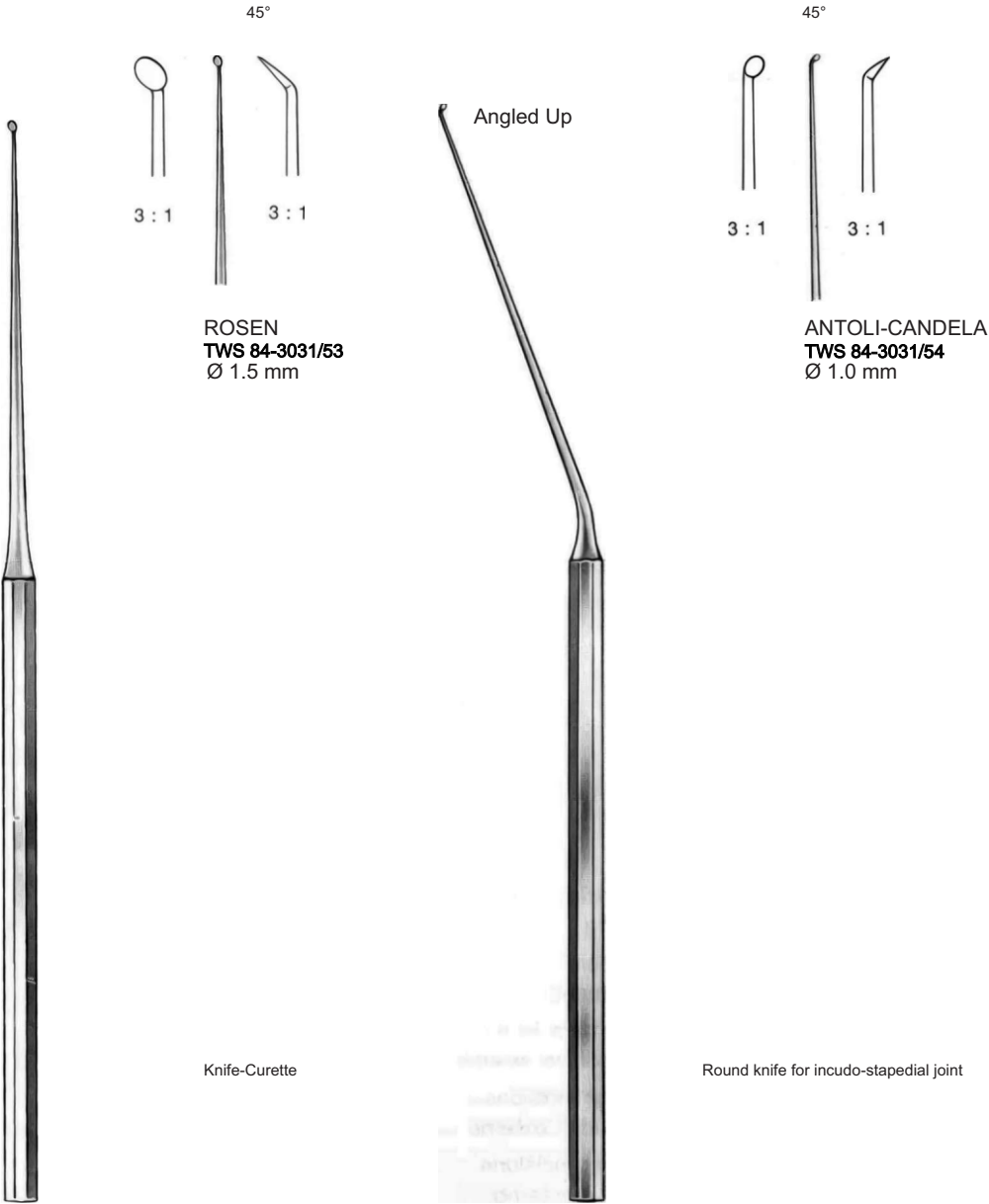



TW Surgical

Knives for Otology

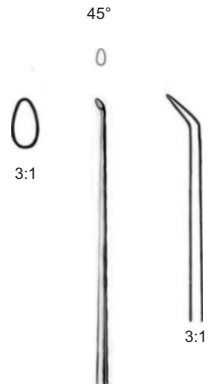

SHEA
TWS 84-3031/55
1.5 X 1 mm

Knife for anterior crurotomy

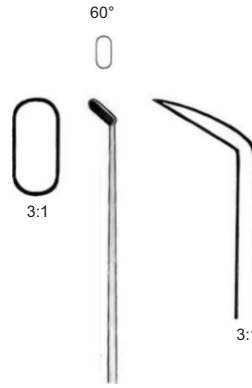

TWS 84-3031/56
4.0 X 2.5 mm

Knife for incising skin of external Auditory meatus

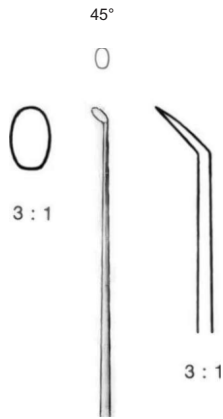

HARRISON
TWS 84-3031/57

Knife for the tympanic membrane

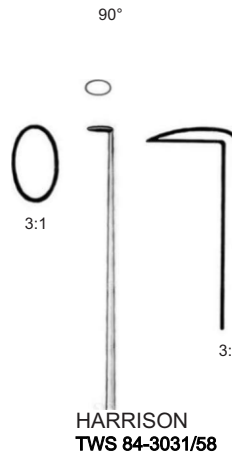

HARRISON
TWS 84-3031/58

Treasure Wright (U.K.) Ltd.

128-160 City Road, London, EC1V 2NX, United Kingdom
info@twrightmedical.com

Knives for Otology



TW Surgical



AUSTIN
TWS 84-3031/59
Ø 2.0 mm

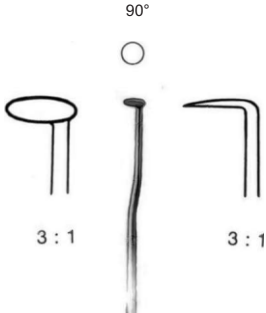

GERLACH
TWS 84-3031/60
Ø 3.0 mm



Round knife for incising skin
of external auditory meatus



TW Surgical

Knives for Otology

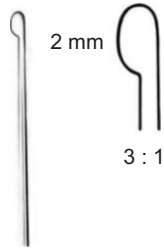

GUILFORD-WRIGHT
TWS 84-3031/61

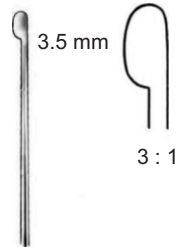

PLESTER
TWS 84-3031/62

Flap knife

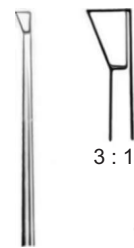

TWS 84-3031/63
2.5 mm

Incision Knife



AUSTIN
TWS 84-3031/64
3.0 X 1.0 mm

Sickle Knife



TWS 84-3031/65

Discision knife for the footplate

Treasure Wright (U.K.) Ltd.

128-160 City Road, London, EC1V 2NX, United Kingdom
info@twrightmedical.com

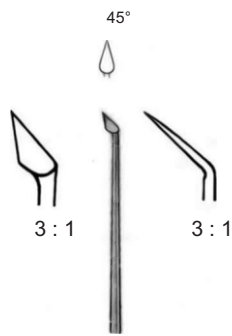

ROSEN
TWS 84-3031/66

Incision knife

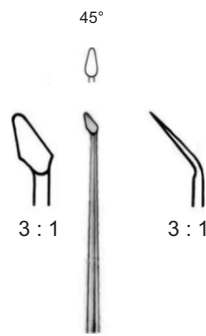

HOUGH
TWS 84-3031/67
2.0 x 1 - 2 mm

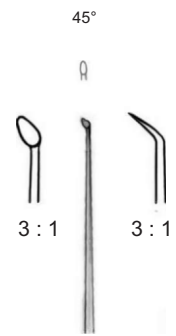

HOUSE
TWS 84-3031/68
2.0 X 1.0 mm

Lancet knife no. 2

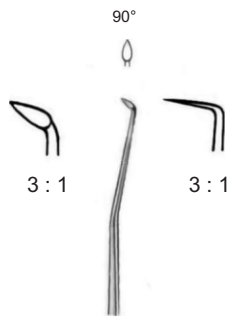

SHEA
TWS 84-3031/69
2.0 X 1.5 mm

Incision knife

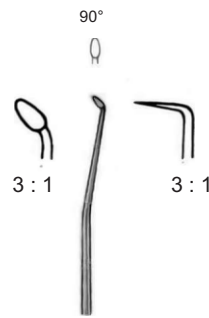

AUSTIN
TWS 84-3031/70
1.8 X 1.2 mm



TW Surgical

Knives for Otology

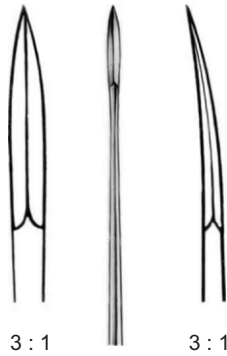

HOUSE
TWS 84-3031/71
4.0 x 1.0 mm

Tympanoplasty knife, also used to excavate around
The malleus to open for prosthesis

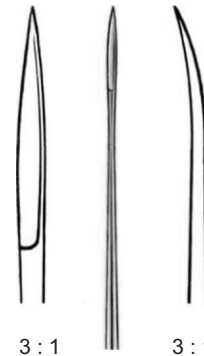

TWS 84-3031/72
3.0 x 1.0 mm

Stapedius tendon knife



GRAY
TWS 84-3031/73
Ø 3.5 mm

Rotary knife for first incision in stapes
Mobilization

Treasure Wright (U.K.) Ltd.

128-160 City Road, London, EC1V 2NX, United Kingdom
info@twrightmedical.com

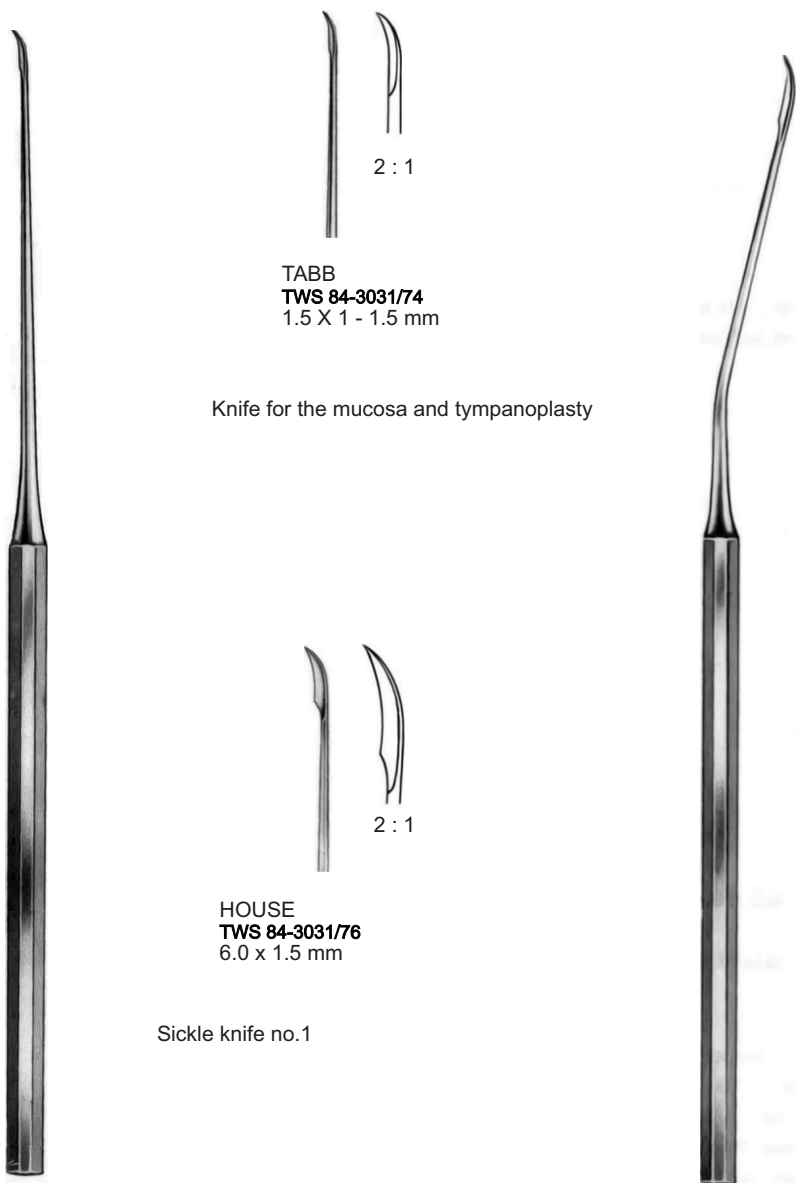

TABB
TWS 84-3031/74
1.5 X 1 - 1.5 mm

Knife for the mucosa and tympanoplasty

SCHUKNECHT
TWS 84-3031/75
5.0 X 1.0 mm

Sickle knife

HOUSE
TWS 84-3031/76
6.0 x 1.5 mm

Sickle knife no.1

Hooks



90°



AUSTIN
TWS 84-3031/77
1.5 mm

25°



SHAMBAUGH
TWS 84-3031/78 0.3 mm
TWS 84-3031/79 0.6 mm
TWS 84-3031/80 1.0 mm

45°



SHAMBAUGH
TWS 84-3031/81 0.3 mm
TWS 84-3031/82 0.6 mm
TWS 84-3031/83 1.0 mm

45°



TWS 84-3031/84 1.5 mm
TWS 84-3031/85 2.5 mm

45°



SHEA
TWS 84-3031/86
2.0 mm

Oblique pick

90°



AUSTIN
TWS 84-3031/87
3.0 mm

Attic Dissector



TW Surgical

Needles

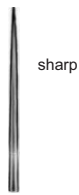

sharp

BARBARA
TWS 84-3031/89



sharp

TWS 84-3031/88



sharp

ROSEN
TWS 84-3031/90



blunt

TWS 84-3031/91



blunt

TWS 84-3031/92

Treasure Wright (U.K.) Ltd.

128-160 City Road, London, EC1V 2NX, United Kingdom
info@twrightmedical.com

Hooks



Angled up

Angled down

25°



TWS 84-3031/93 0.3 mm
TWS 84-3031/94 0.6 mm
TWS 84-3031/95 1.0 mm

TWS 84-3031/96 0.3 mm
TWS 84-3031/97 0.6 mm
TWS 84-3031/98 1.0 mm

45°



TWS 84-3031/99 0.3 mm
TWS 84-3032/00 0.6 mm
TWS 84-3032/01 1.0 mm

TWS 84-3032/02 0.3 mm
TWS 84-3032/03 0.6 mm
TWS 84-3032/04 1.0 mm

90°



TWS 84-3032/05 0.3 mm
TWS 84-3032/06 0.6 mm
TWS 84-3032/07 1.0 mm

TWS 84-3032/08 0.3 mm
TWS 84-3032/09 0.6 mm
TWS 84-3032/10 1.0 mm

Treasure Wright (U.K.) Ltd.

128-160 City Road, London, EC1V 2NX, United Kingdom
info@twrightmedical.com



TW Surgical

Hooks

90°



SHAMBAUGH
 TWS 84-3032/11 0.3 mm
 TWS 84-3032/12 0.6 mm
 TWS 84-3032/13 0.8 mm
 TWS 84-3032/14 1.0 mm

TWS 84-3032/15 1.2 mm
 TWS 84-3032/16 1.5 mm
 TWS 84-3032/17 2.5 mm



TWS 84-3032/18 0.5 mm
 TWS 84-3032/19 1.0 mm



GOLDMANN
 TWS 84-3032/20

Retractor for malleus



PLESTER
 TWS 84-3032/21

For roughening the back of the Tympanic membrane



ROSEN
 TWS 84-3032/22

Oval window fenestrator

sharp

Treasure Wright (U.K.) Ltd.

128-160 City Road, London, EC1V 2NX, United Kingdom
info@twrightmedical.com

Hooks

curved up

curved down

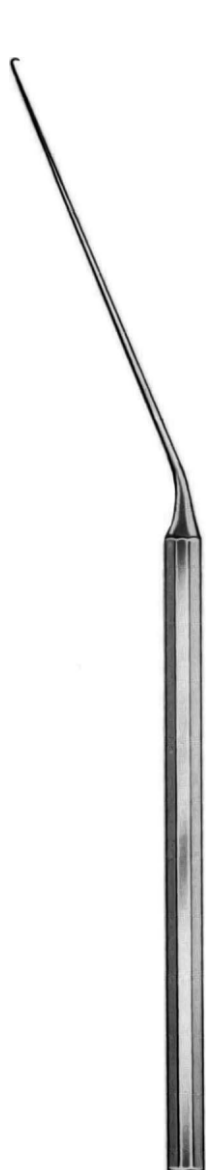

MCGEE
TWS 84-3032/23 0.5 mm
TWS 84-3032/24 1.0 mm



MCGEE
TWS 84-3032/25 0.5 mm
TWS 84-3032/26 1.0 mm



FISCH
TWS 84-3032/27 0.2 mm
PLESTER
TWS 84-3032/28 0.6 mm

Footplate hook



TW Surgical

Hooks

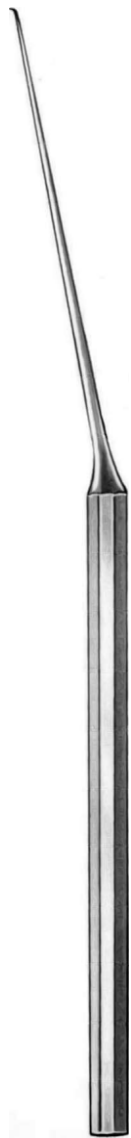

angled right

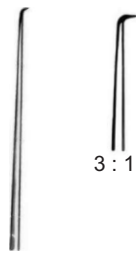

3 : 1

ANTOLI-CANDELA
TWS 84-3032/29
0.6 mm

angled left



3 : 1

ANTOLI-CANDELA
TWS 84-3032/30
0.6 mm

90°

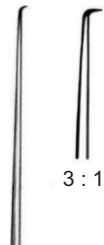

3 : 1

TWS 84-3032/31
1.0 mm



3 : 1

TWS 84-3032/32
1.0 mm

90°

for lifting incus

Treasure Wright (U.K.) Ltd.

128-160 City Road, London, EC1V 2NX, United Kingdom
info@twrightmedical.com



TW Surgical

Raspatories/Elevators



○



AUSTIN
TWS 84-3032/33

Raspatory (Round knife),
Ø 2 mm, angled up 90°

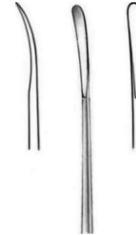

ANTOLI-CANDELA
TWS 84-3032/34

Elevator (Raspatory) for
Dissection of soft tissue,
1.8 mm wide, curved

15 x 1.5 mm



ROSEN
TWS 84-3032/35

15 x 1.0 mm



ROSEN
TWS 84-3032/36

15 x 1.2 mm



ROSEN
TWS 84-3032/37

Treasure Wright (U.K.) Ltd.

128-160 City Road, London, EC1V 2NX, United Kingdom
info@twrightmedical.com

Elevators

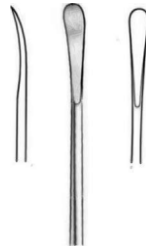

GOLDMANN
TWS 84-3032/38

Elevator and dissecting knife for soft
Tissues, oval shape, 2.5 mm wide,
Light curve



HOUSE
TWS 84-3032/39

Stapes-elevator, blade 12 mm long,
1 mm wide, slightly angled up



SHEA
TWS 84-3032/40

Right

1.2 mm



SHEA
TWS 84-3032/41

Left

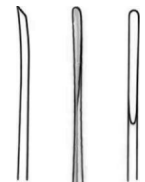

1.5 mm

blunt

SHAMBAUGH-DERLACKI
TWS 84-3032/42
14 cm - 5½"z



TW Surgical

Raspatories / Elevators



SHAMBAUGH-DERLACKI
TWS 84-3032/43
14.5 cm - 5³/₄"

Elevator (Raspatory), 2, 0 mm wide,
Angled tip



SHAMBAUGH-DERLACKI
TWS 84-3032/44
14.5 cm - 5³/₄"

Duckbill Elevator (Raspatory)
3 mm wide, slightly curved

Treasure Wright (U.K.) Ltd.

128-160 City Road, London, EC1V 2NX, United Kingdom
info@twrightmedical.com



SCHUKNECHT
TWS 84-3032/45

Mucosa Elevator, flat, 1 mm wide,
tip slightly curved up



Right
Direito
Droit

HOUGH
TWS 84-3032/46



Left
Esquerdo
Gauche

HOUGH
TWS 84-3032/47

Excavator for oval window, heavy pattern

Mobilizers, Plugger

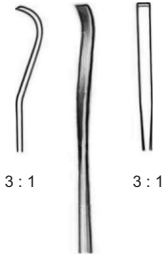

ROSEN
TWS 84-3032/48

Mobilizer, 1.8mm wide



GOLDMANN
TWS 84-3032/49

Mobilizer with ball tip, Ø 0.8 mm,
Angled up 25°



GOLDMANN
TWS 84-3032/50

Plugger with ball tip, Ø 1.0 mm,
For placing implant material



TW Surgical

Measuring Rods, Wire Guide



ANTOLI-CANDELA
TWS 84-3032/51

Measuring rod, markers at 4.0 mm, 4.5 mm and 5 mm



HOUGH
TWS 84-3032/52

Measuring rod, markers at 3.5 mm, 4 mm and 4.5 mm



AUSTIN
TWS 84-3032/53

Measuring and introduction probe for incudo Stapedial prostheses, marking at 3.5 4 and 4.5 mm



TWS 84-3032/54

Wire guide and applicator for prosthesis, V-notch , light curve



TW Surgical

Sharp Currettes

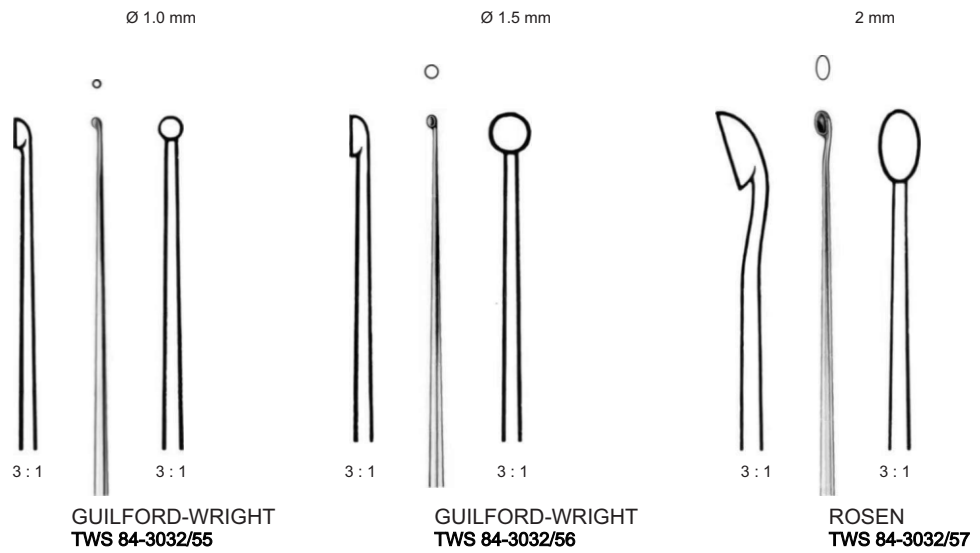

Curette, for tympanoplasty and myringoplasty

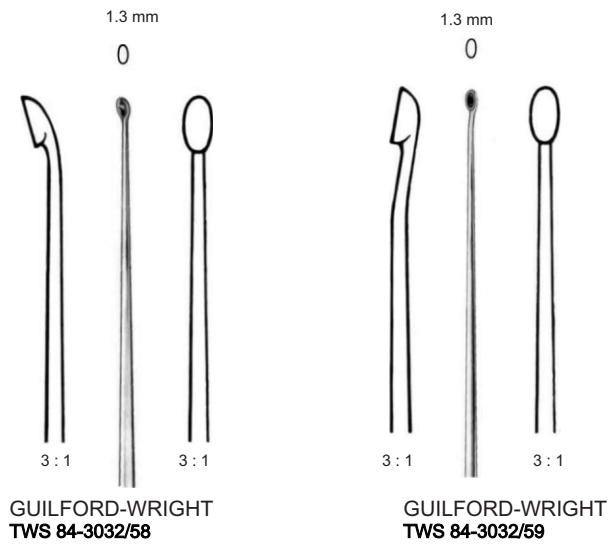

Curette, for tympanoplasty and myringoplasty



Treasure Wright (U.K.) Ltd.

128-160 City Road, London, EC1V 2NX, United Kingdom
info@twrightmedical.com

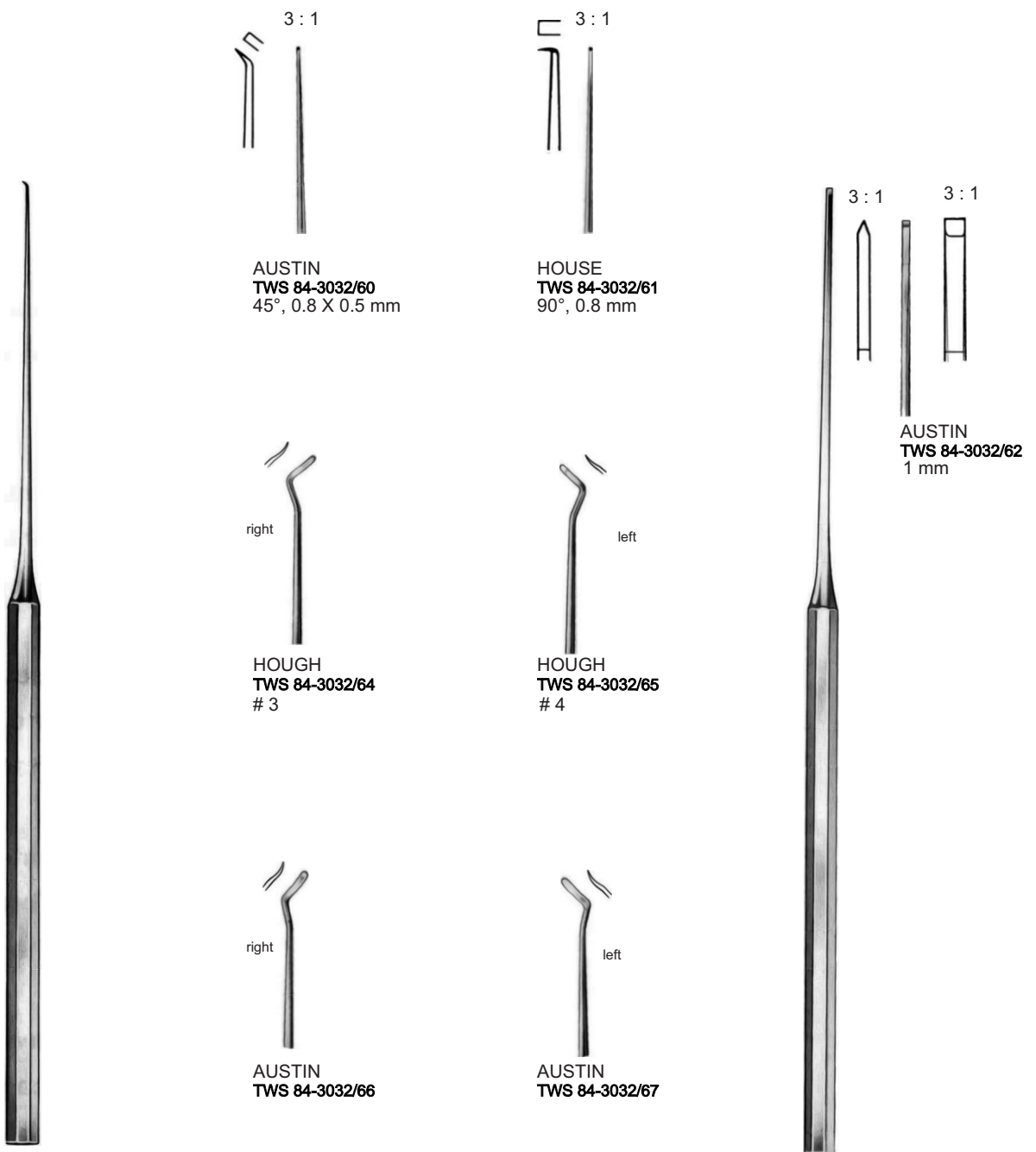



TW Surgical

Sharp Curettes

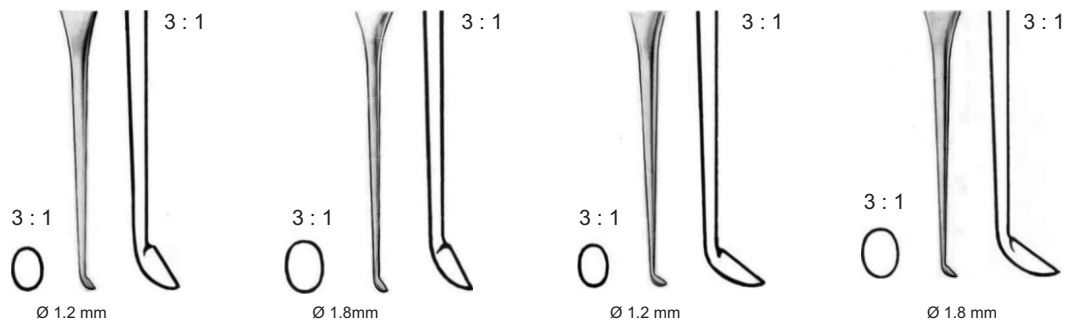
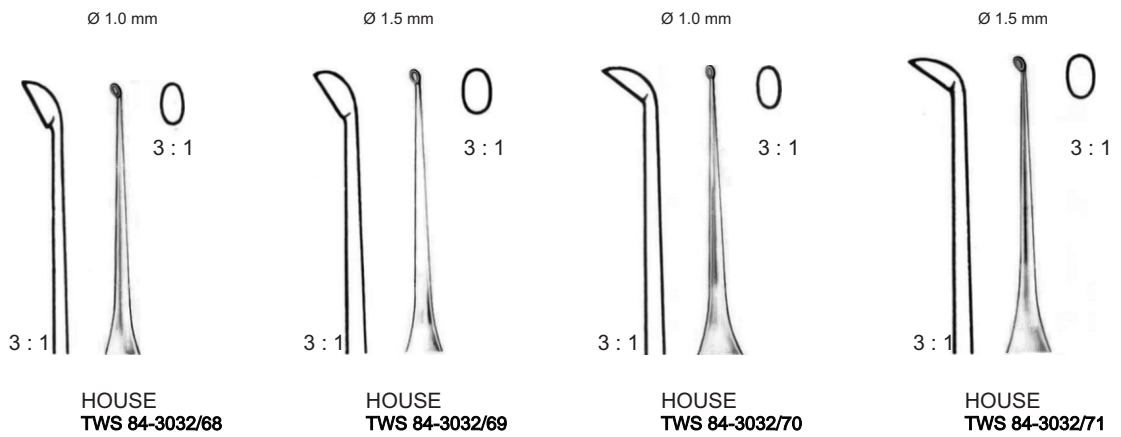

Double-ended Curette for Stapedectomy, Cups slightly angled forwards

Double-ended curette for stapedectomy, Cups strongly angled forwards

Treasure Wright (U.K.) Ltd.

128-160 City Road, London, EC1V 2NX, United Kingdom
info@twrightmedical.com

Sharp Curettes



GUILFORD-WRIGHT
TWS 84-3032/72

Curette for stapedectomy, cups slightly
Angled forwards

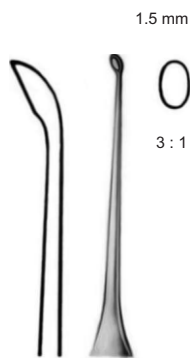

GUILFORD-WRIGHT
TWS 84-3032/73

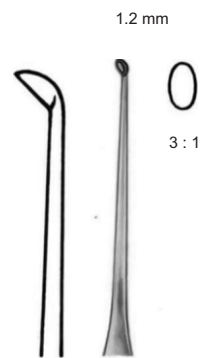

GUILFORD-WRIGHT
TWS 84-3032/74

Curette for stapedectomy, cups strongly
Angled forwards

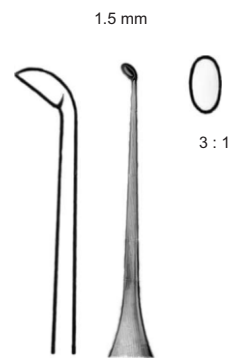

GUILFORD-WRIGHT
TWS 84-3032/75



TW Surgical

Sharp Curettes

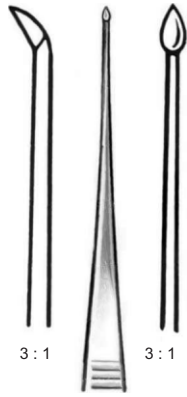

TWS 84-3032/76
17 cm - 6³/₄"

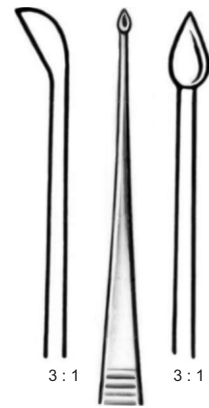

TWS 84-3032/77
17 cm - 6³/₄"

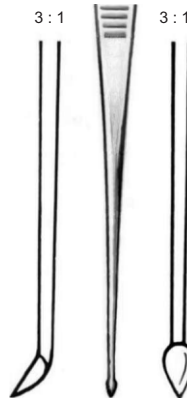

Double-ended curette for
Stapedectomy, pointed, small

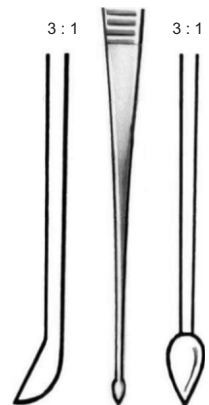

Double-ended curette for
Stapedectomy, pointed, large

Treasure Wright (U.K.) Ltd.

128-160 City Road, London, EC1V 2NX, United Kingdom
info@twrightmedical.com



TW Surgical

Irrigating Tube for Maxillary Cavity



EICKEN
TWS 84-3032/80
15 cm - 6"

With luer cone



KILLIAN
TWS 84-3032/81 # 1
TWS 84-3032/82 # 2
15 cm - 6"

TWS 84-3032/78
1 - Ø 3 mm

TWS 84-3032/79
2 - Ø 3.5 mm



KILLIAN
TWS 84-3032/83
18 cm - 7 1/4"

Malleable

With RECORD cone

1 - Ø 1.5 mm

2 - Ø 1.5 mm



VAN ALYEA
TWS 84-3032/84
12 cm - 4 3/4"



VAN ALYEA
TWS 84-3032/85
12 cm - 4 3/4"

LUER-LOCK

Treasure Wright (U.K.) Ltd.

128-160 City Road, London, EC1V 2NX, United Kingdom
info@twrightmedical.com

Irrigating Tube for Maxillary Cavity

Irrigating Tubes

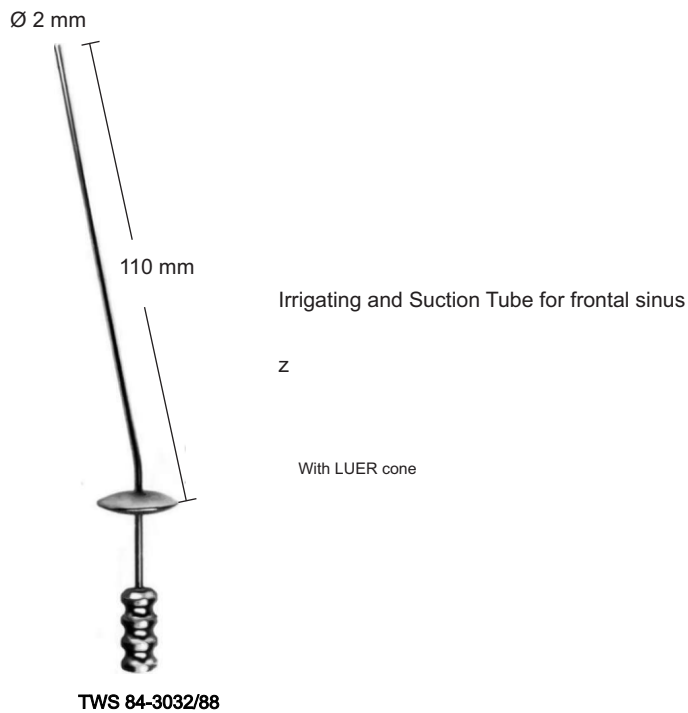
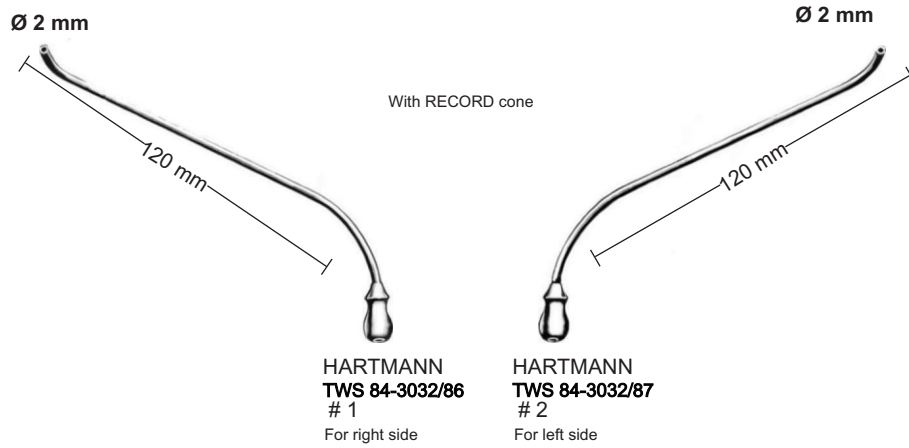

Treasure Wright (U.K.) Ltd.

128-160 City Road, London, EC1V 2NX, United Kingdom
info@twrightmedical.com



TW Surgical

Nasal Polypus Snares



KRAUSE
TWS 84-3032/89
25 cm - 10"



KRAUSE-VOSS
TWS 84-3032/90
25 cm - 10"

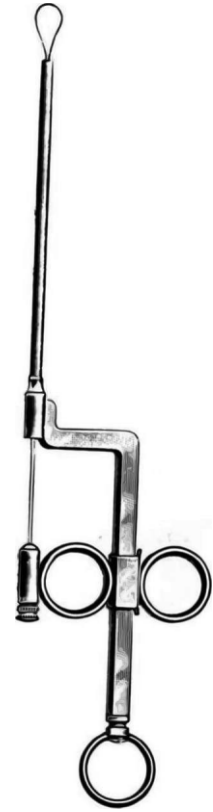

WILDE (BRUENINGS)
TWS 84-3032/91
25 cm - 10"

Snare Wire



TWS 84-3032/92
0.3 mm

Package / 100



TWS 84-3032/93 0.35 mm
TWS 84-3032/94 0.40 mm
TWS 84-3032/95 0.45 mm

Coil/10 meters

Treasure Wright (U.K.) Ltd.

128-160 City Road, London, EC1V 2NX, United Kingdom
info@twrightmedical.com



TW Surgical

Nasal Dressing Forceps



delicate pattern

HARTMANN
TWS 84-3032/96
18 cm - 7¼"



standard pattern

HARTMANN
TWS 84-3032/97
20 cm - 8"

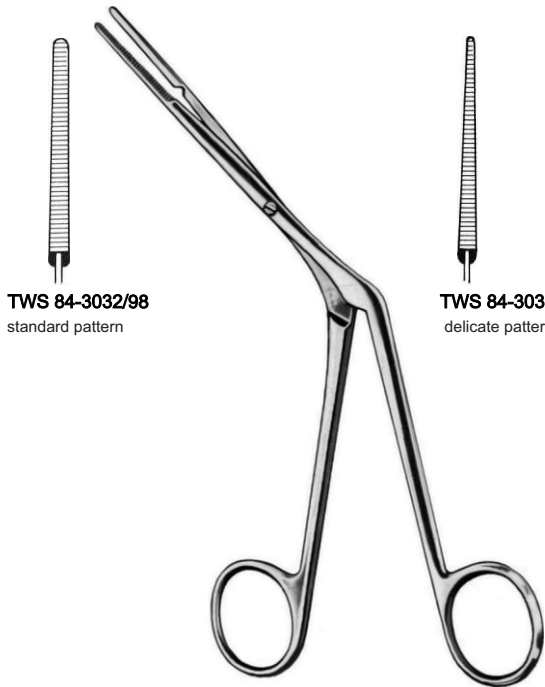

TWS 84-3032/98
standard pattern

TWS 84-3032/99
delicate pattern

WESTMACOTT
20 cm - 8"



LUBET-BARBON
TWS 84-3033/00
20 cm - 8"

Treasure Wright (U.K.) Ltd.

128-160 City Road, London, EC1V 2NX, United Kingdom
info@twrightmedical.com



TW Surgical

Nasal Specula



Nasal septum speculum



COTTLE
TWS 84-3033/05
14 cm - 5½"

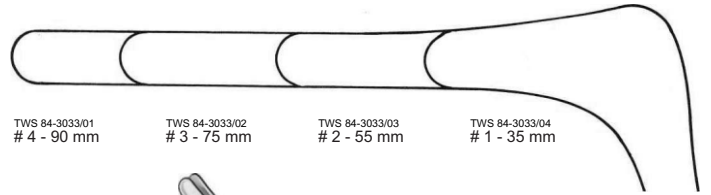

TWS 84-3033/01
4 - 90 mm

TWS 84-3033/02
3 - 75 mm

TWS 84-3033/03
2 - 55 mm

TWS 84-3033/04
1 - 35 mm



COTTLE
TWS 84-3033/06 # 1
TWS 84-3033/07 # 2
TWS 84-3033/08 # 3
TWS 84-3033/09 # 4
14 cm - 5½"

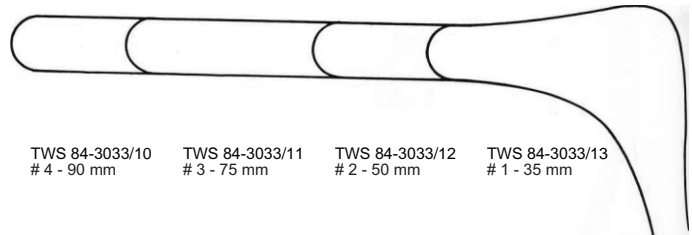

TWS 84-3033/10
4 - 90 mm

TWS 84-3033/11
3 - 75 mm

TWS 84-3033/12
2 - 50 mm

TWS 84-3033/13
1 - 35 mm



BECKMANN
15 cm - 6"



TWS 84-3033/14
1



TWS 84-3033/15
2



TWS 84-3033/16
3



KILLIAN
TWS 84-3033/17 # 1
TWS 84-3033/18 # 2
TWS 84-3033/19 # 3
TWS 84-3033/20 # 4
14 cm - 5½"

Treasure Wright (U.K.) Ltd.

128-160 City Road, London, EC1V 2NX, United Kingdom
info@twrightmedical.com

Nasal Specula

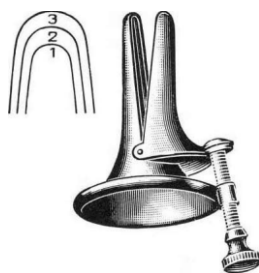
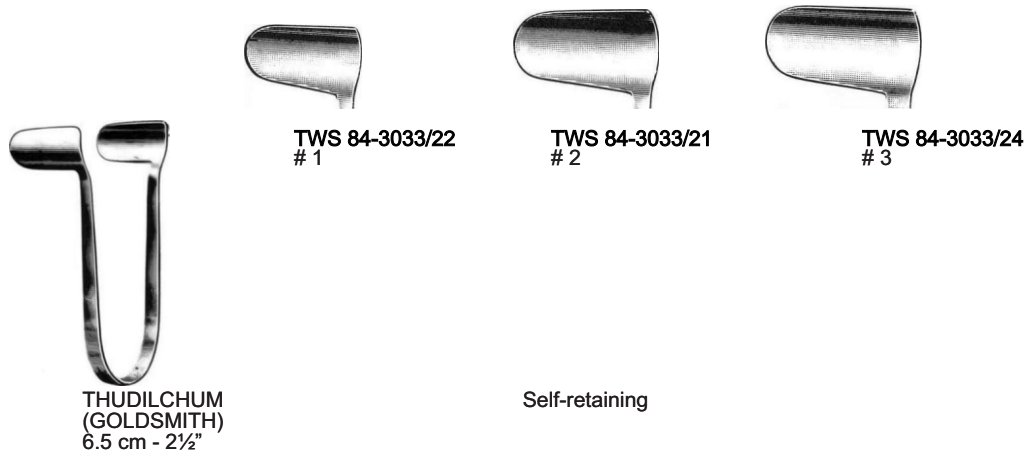

VOLTOLINI
(DUPLAY)
TWS 84-3033/25 #1
TWS 84-3033/26 #2
TWS 84-3033/27 #3

Self-retaining, spread adjustable by set screw

Nasal Scissors



Serrated cutting blades

Angled to side

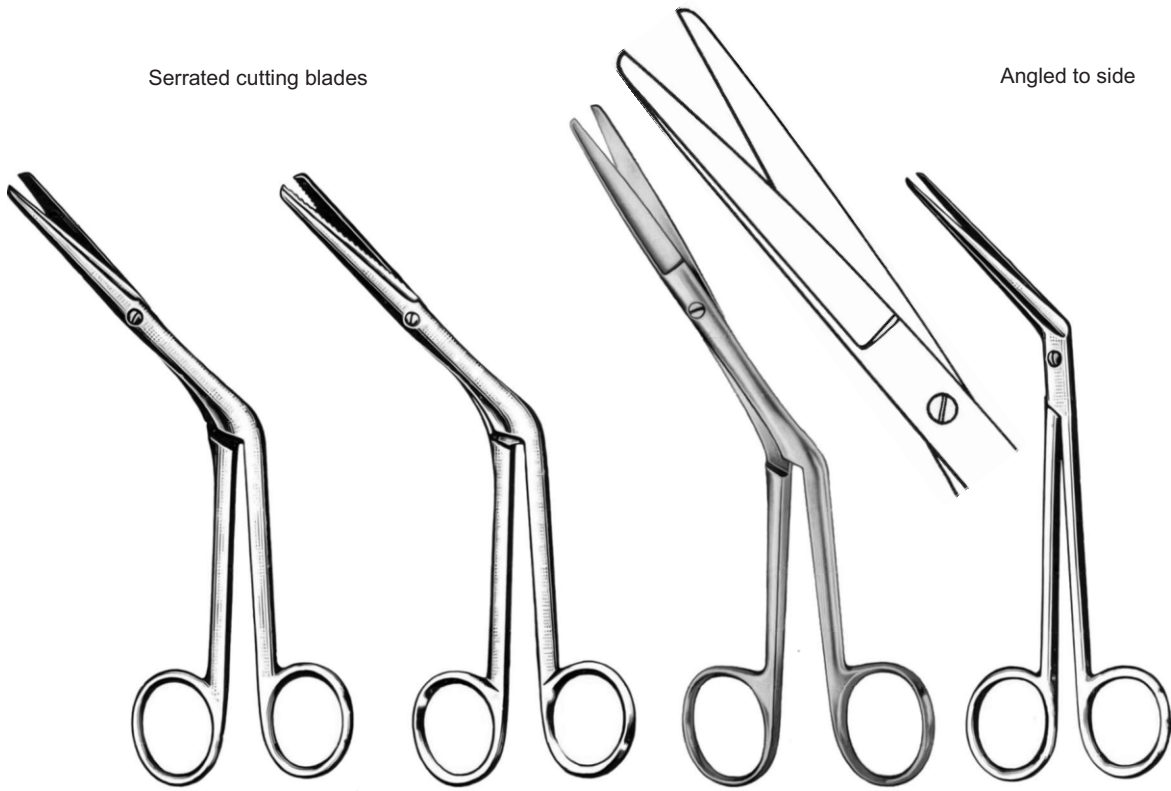

HEYMANN
TWS 84-3033/28
17 cm - 6³/₄"

HEYMANN
TWS 84-3033/29
17 cm - 6³/₄"

HEYMANN
TWS 84-3033/30
20 cm - 8"

SEILER
TWS 84-3033/31
17 cm - 6³/₄"

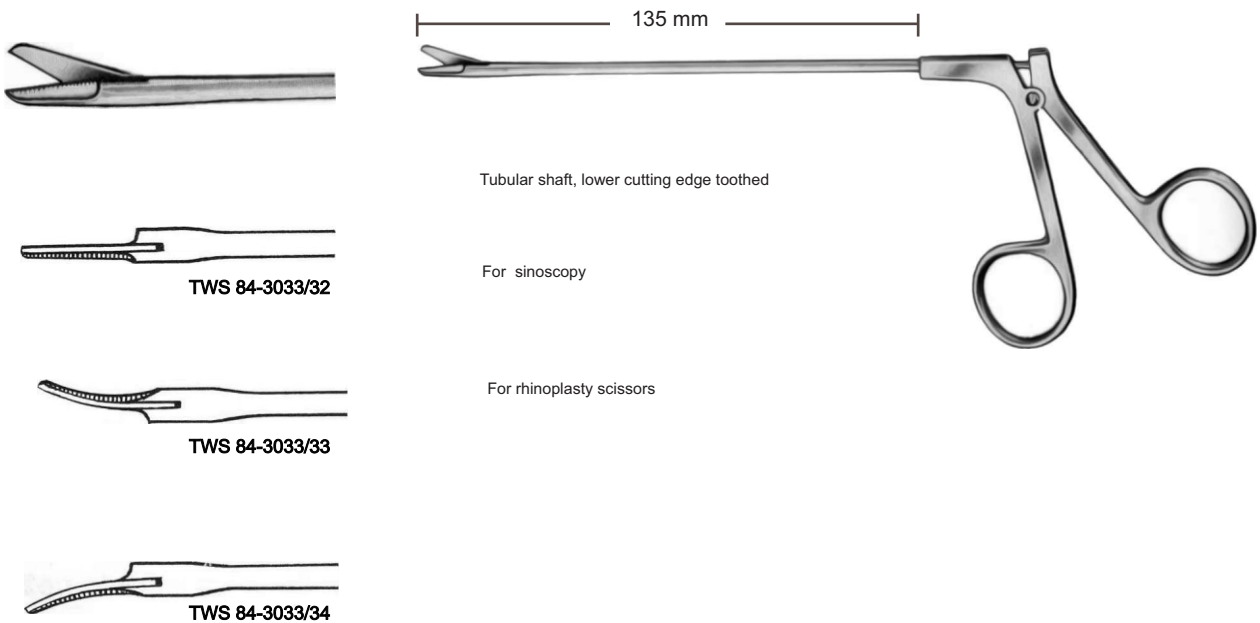

Tubular shaft, lower cutting edge toothed

For sinuscopy

For rhinoplasty scissors

TWS 84-3033/32

TWS 84-3033/33

TWS 84-3033/34

Treasure Wright (U.K.) Ltd.

128-160 City Road, London, EC1V 2NX, United Kingdom
info@twrightmedical.com



TW Surgical

Rhinoplasty Scissors

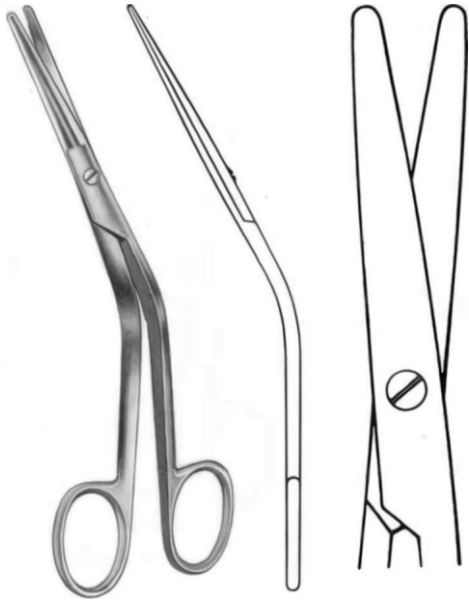

COTTLE
TWS 84-3033/35
16 cm - 6¼"

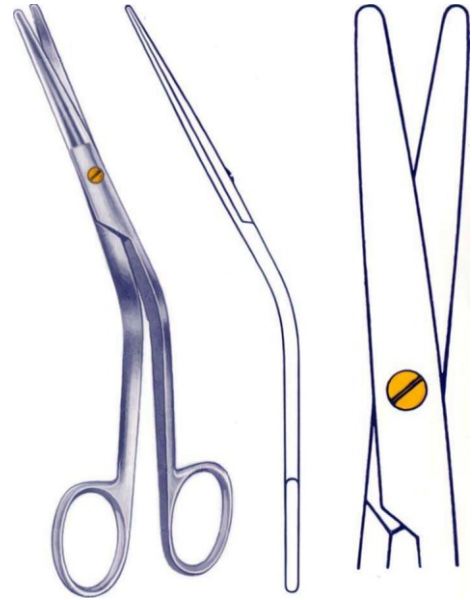

COTTLE
SUPERCUT
TWS 84-3033/36
16 cm - 6¼"



COTTLE
"HM"
TWS 84-3033/37
16 cm - 6¼"

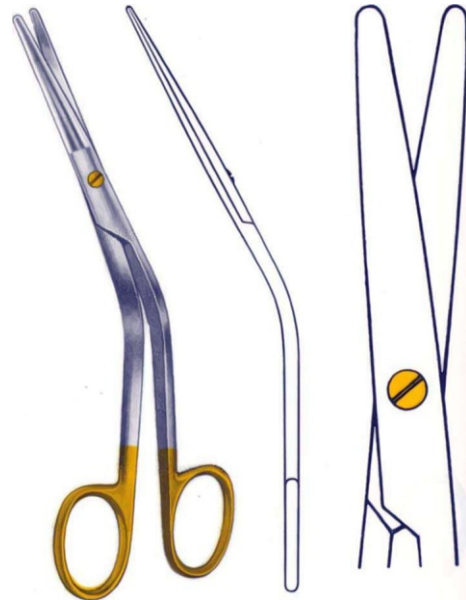

COTTLE
SUPERCUT PLUS
TWS 84-3033/38
16 cm - 6¼"

Treasure Wright (U.K.) Ltd.

128-160 City Road, London, EC1V 2NX, United Kingdom
info@twrightmedical.com



TW Surgical

Knives

Cartilage knife



MASING
TWS 84-3033/39
13 cm - 5 1/4"

Septum knife, adjustable

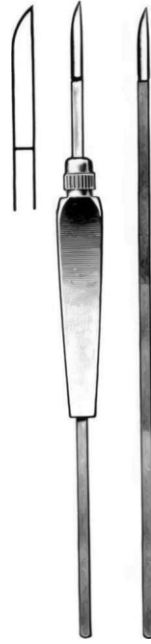

spare blade

BRUENINGS
TWS 84-3033/40
16 cm - 6 1/4"



FREER
TWS 84-3033/41
15 cm - 6"



FREER
TWS 84-3033/42
16 cm - 6 1/4"
"D"



FREER
TWS 84-3033/43
15 cm - 6 1/4"
"E"

Mucosa knife

Treasure Wright (U.K.) Ltd.

128-160 City Road, London, EC1V 2NX, United Kingdom
info@twrightmedical.com



TW Surgical

Septum Elevators



HOWARTH
TWS 84-3033/44
21.5 cm - 8½"



PENNINGTON
TWS 84-3033/45
20 cm - 8"



PIERCE
TWS 84-3033/46
20 cm - 8"

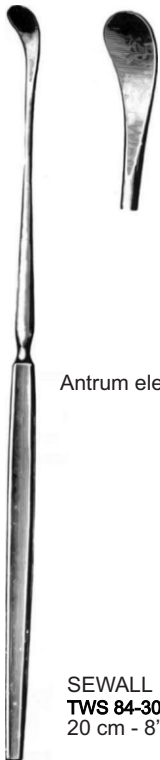

Antrum elevator

SEWALL
TWS 84-3033/47
20 cm - 8"

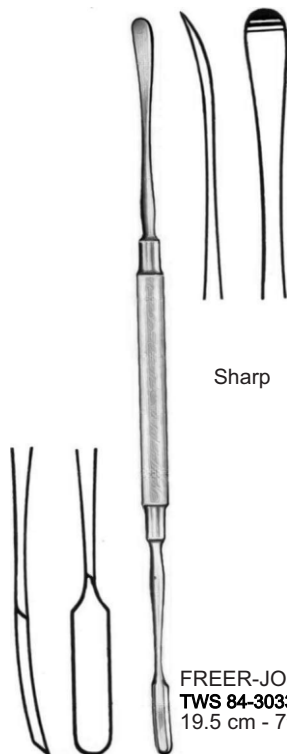

Sharp

FREER-JOSEPH
TWS 84-3033/48
19.5 cm - 7¾"



Sharp/Blunt

HAJEK-BALLENGER
TWS 84-3033/49
20 cm - 8"

Treasure Wright (U.K.) Ltd.

128-160 City Road, London, EC1V 2NX, United Kingdom
info@twrightmedical.com



TW Surgical

Nasal Probes



KISTNER
17 cm - 6¾"



TWS 84-3033/50



TWS 84-3033/51



Obturator



Choana Hook



TWS 84-3033/52
14.5 cm - 5¾"



KILLIAN
TWS 84-3033/53
15 cm - 6"

LANGE
TWS 84-3033/54
23 cm - 9"

Treasure Wright (U.K.) Ltd.

128-160 City Road, London, EC1V 2NX, United Kingdom
info@twrightmedical.com



TW Surgical

Nasal Septum Forceps

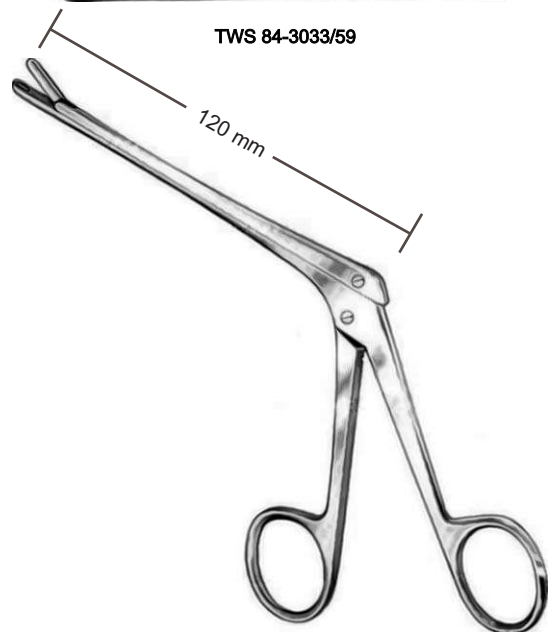
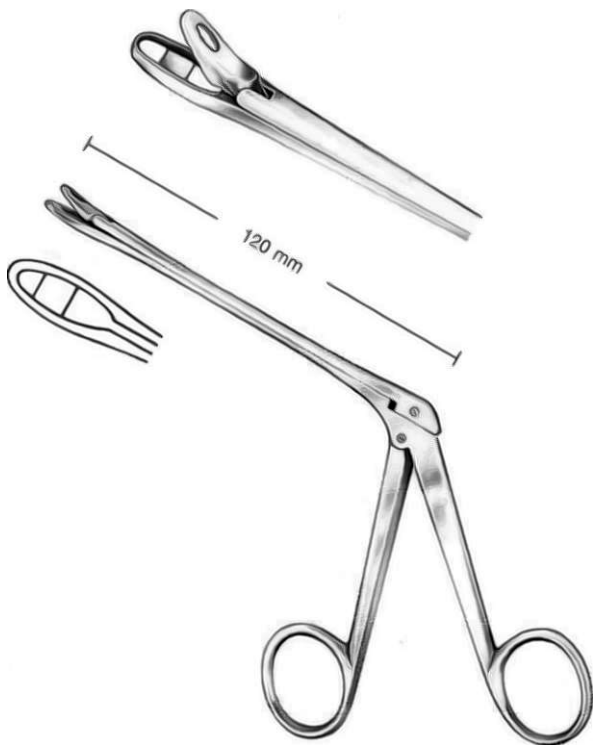
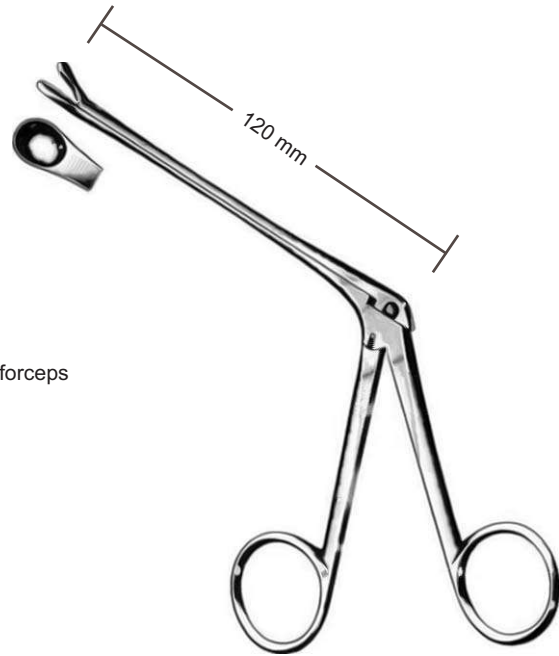
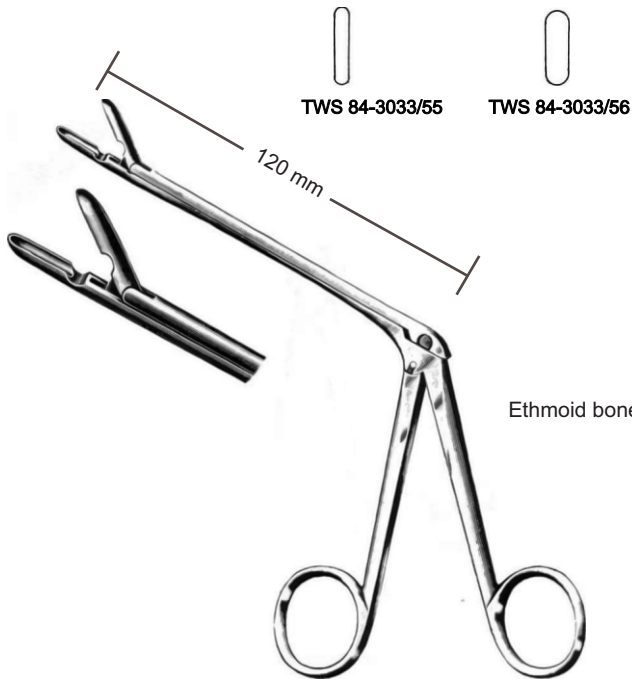

Treasure Wright (U.K.) Ltd.

128-160 City Road, London, EC1V 2NX, United Kingdom
info@twrightmedical.com

Nasal Septum Forceps

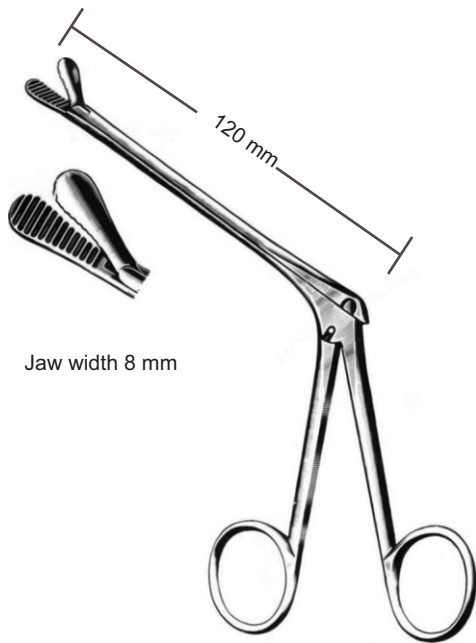

Jaw width 8 mm

**BLAKESLEY
TWS 84-3033/61**

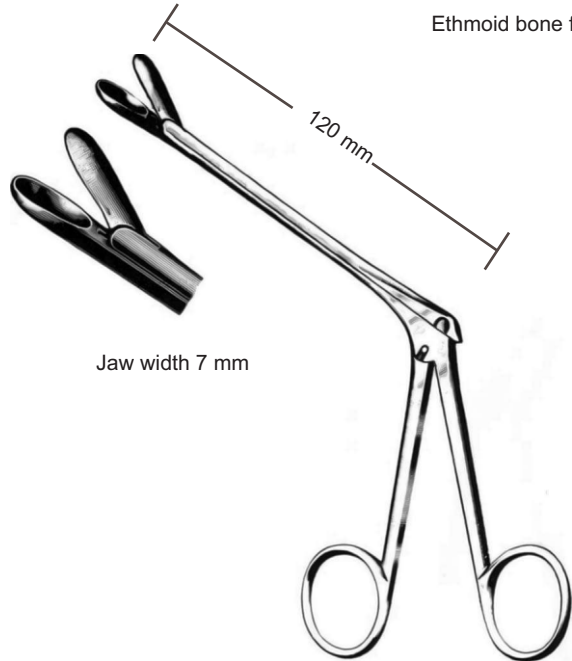

Ethmoid bone forceps

Jaw width 7 mm

**WATSON-WILLIAMS
TWS 84-3033/62**

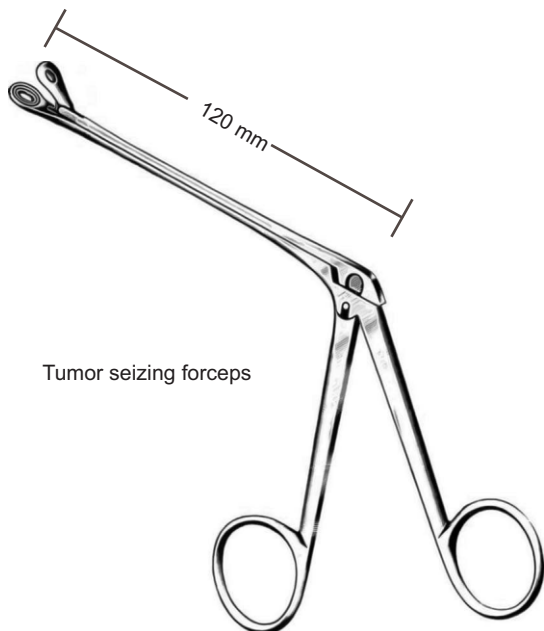

Tumor seizing forceps

**BLAKESLEY
(LEWIS)**



**TWS 84-3033/66
TWS 84-3033/67
TWS 84-3033/68**



TWS 84-3033/63



TWS 84-3033/64



TWS 84-3033/65



TW Surgical

Nasal Septum Forceps

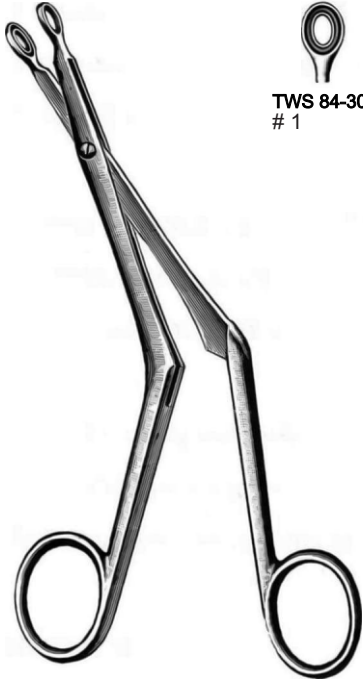

BRUENINGS
19 cm - 7½"



TWS 84-3033/69
1



TWS 84-3033/70
2



TWS 84-3033/71
3

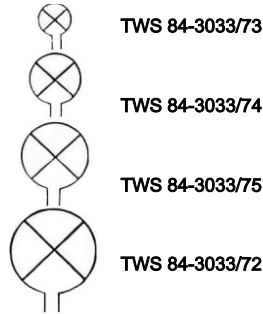
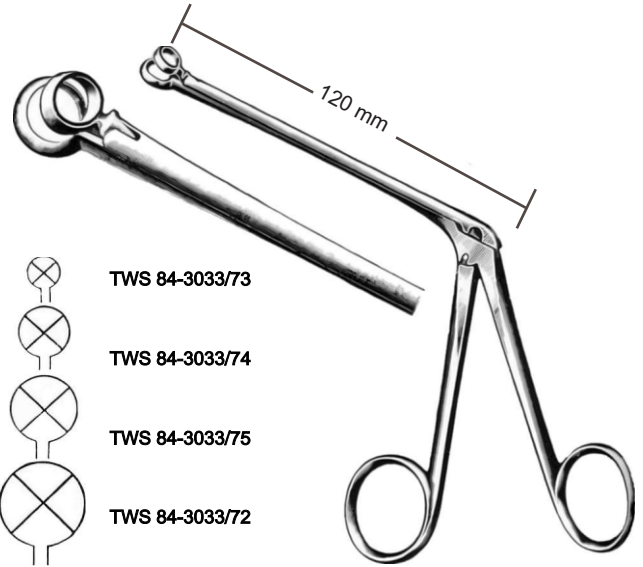

TWS 84-3033/73

TWS 84-3033/74

TWS 84-3033/75

TWS 84-3033/72

HARTMANN
TWS 84-3033/76 # 1
TWS 84-3033/77 # 2
TWS 84-3033/78 # 3
TWS 84-3033/79 # 4



TWS 84-3033/81



TWS 84-3033/82



TWS 84-3033/80

WATSON-WILLIAMS
TWS 84-3033/87 # 1
TWS 84-3033/88 # 2
TWS 84-3033/89 # 3

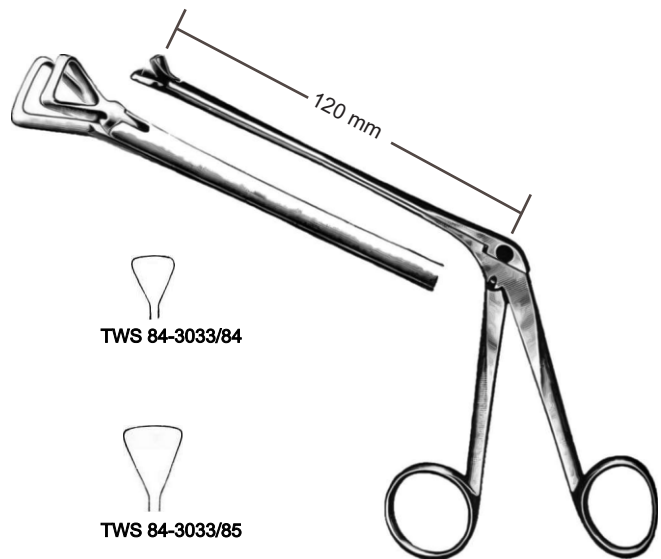

TWS 84-3033/84



TWS 84-3033/85



TWS 84-3033/86

SCHMEDEN
TWS 84-3033/90 # 1
TWS 84-3033/91 # 2
TWS 84-3033/92 # 3

Treasure Wright (U.K.) Ltd.

128-160 City Road, London, ECLV 2NX, United Kingdom
info@twrightmedical.com

Nasal Septum Forceps



TW Surgical

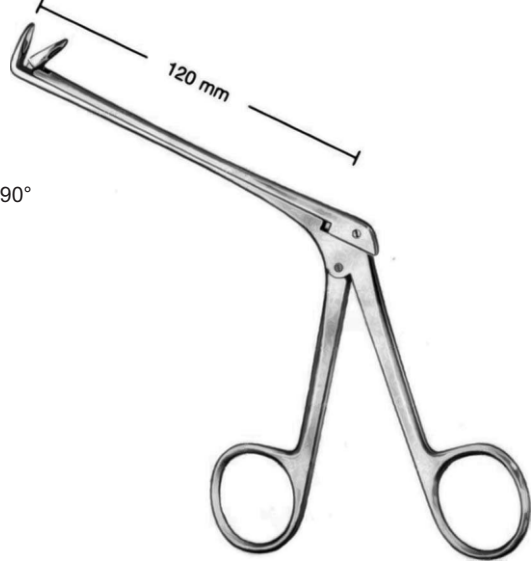

90°

120 mm

WELL-BLAKESLEY



TWS 84-3033/94
1



TWS 84-3033/96
2



TWS 84-3033/95
3



TWS 84-3033/97
4



TW Surgical

Nasal Forceps, through-cutting

Antrum punch, retrograde cutting

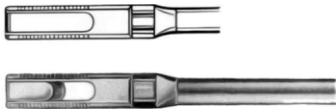

TWS 84-3033/98

Up cutting

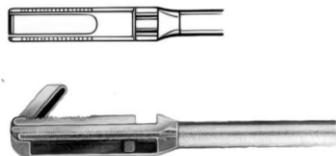

TWS 84-3033/99

Cutting right

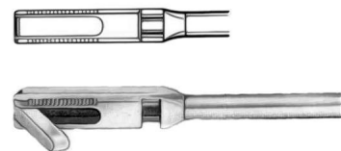

TWS 84-3034/00

Cutting left

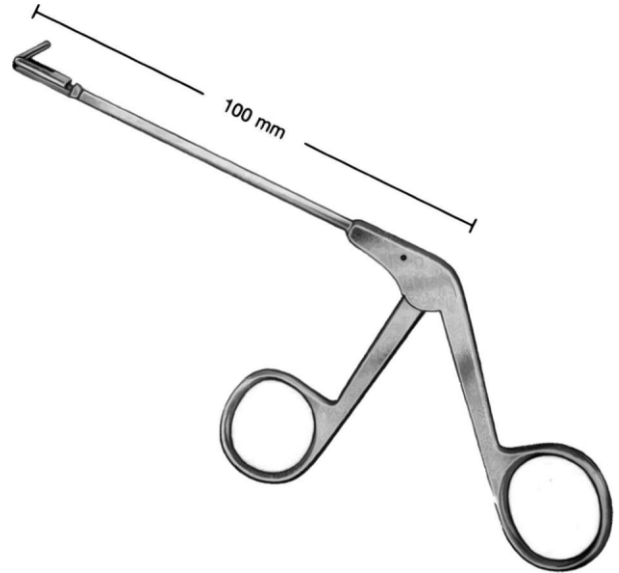

STAMMBERGER

Treasure Wright (U.K.) Ltd.

128-160 City Road, London, EC1V 2NX, United Kingdom
info@twrightmedical.com



TW Surgical

Nasal Hooks and Retractors

12 mm

Sharp

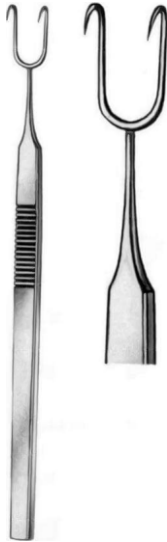

COTTLE
TWS 84-3034/01
14 cm - 5½"

10 mm

Sharp



COTTLE
TWS 84-3034/02
14 cm - 5½"

10 mm

Sharp

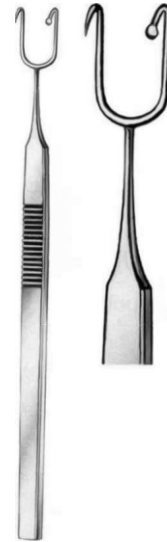

COTTLE
TWS 84-3034/03
14 cm - 5½"

Alar retractor

10 mm

Sharp



KILNER
TWS 84-3034/04
10 cm - 4"

10 mm

Sharp



CONVERSE
TWS 84-3034/05
12 cm - 4¾"

4 mm

Sharp

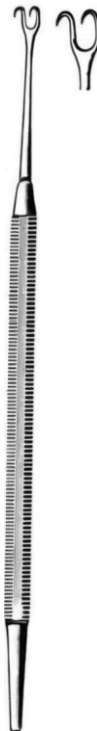

COTTLE
TWS 84-3034/06
15 cm - 6"

Treasure Wright (U.K.) Ltd.

128-160 City Road, London, EC1V 2NX, United Kingdom
info@twrightmedical.com

Nasal Hooks and Retractors



TWS 84-3034/07
No. 1 - 40 mm

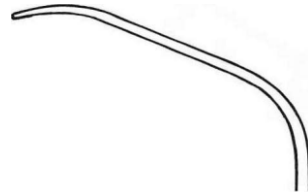

TWS 84-3034/08
No. 2 - 50 mm

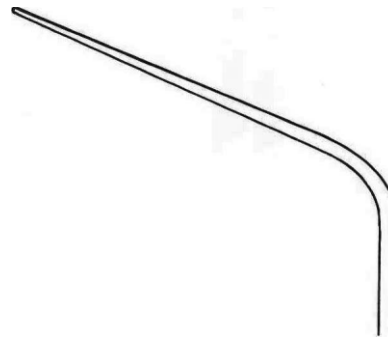

TWS 84-3034/09
No. 3 - 55 mm

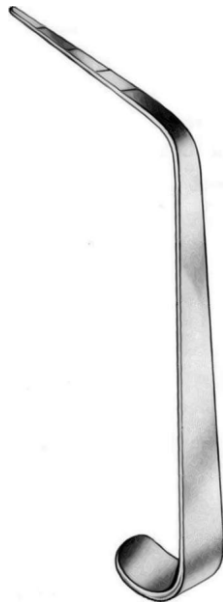
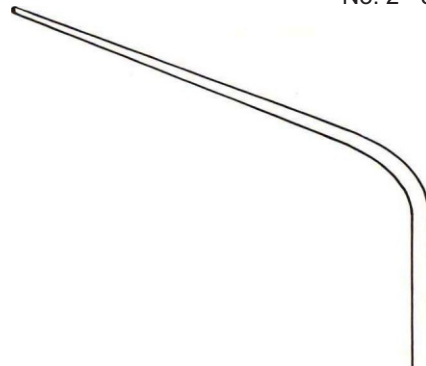

COTTLE

TWS 84-3034/10
Set/4 sizes (No, 1-4)

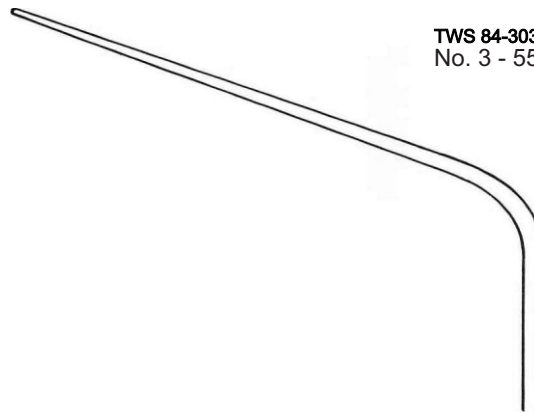

TWS 84-3034/11
No. 4 - 70 mm

Rhinoplasty Knives



TW Surgical



JOSEPH
TWS 84-3034/12
15 cm - 6"

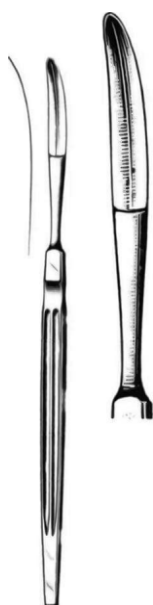

JOSEPH
TWS 84-3034/13
15 cm - 6"

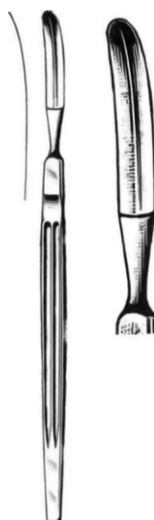

FOMON
TWS 84-3034/14
15 cm - 6"



JOSEPH
TWS 84-3034/15
15 cm - 6"



Nasal knife

COTTLE
TWS 84-3034/16
14 cm - 5½"

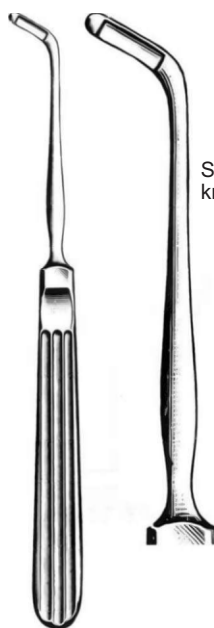

Septum cartilage
knife

JOSEPH
TWS 84-3034/17
16 cm - 6¼"

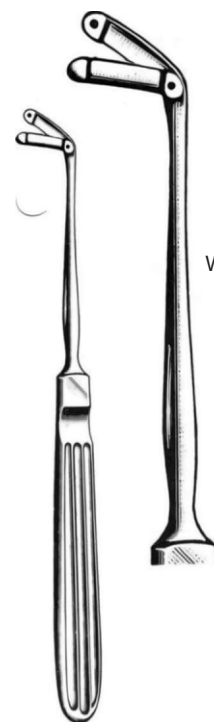

With blade guard

MALTZ
TWS 84-3034/18
16 cm - 6¼"

Treasure Wright (U.K.) Ltd.

128-160 City Road, London, EC1V 2NX, United Kingdom
info@twrightmedical.com

Cartilage Abraders, Nasal Rasps



Cartilage Abraders

DINGMAN
TWS 84-3034/19
Set of 2 (# 1 and 2)

DINGMAN
TWS 84-3034/20
15 cm - 6" # 1 - L



DINGMAN
TWS 84-3034/21
15 cm - 6" # 2 - R



AUFRICHT
TWS 84-3034/22
21 cm - 8 1/4"

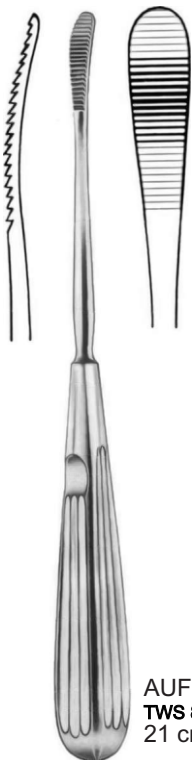

AUFRICHT
TWS 84-3034/23
21 cm - 8 1/4"

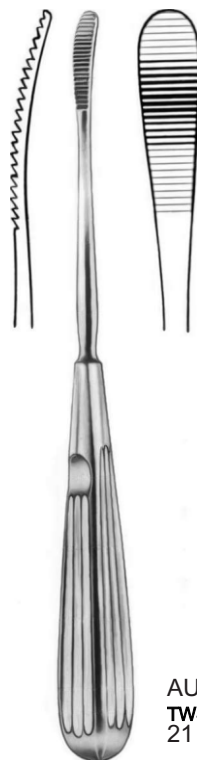

AUFRICHT
TWS 84-3034/24
21 cm - 8 1/4"

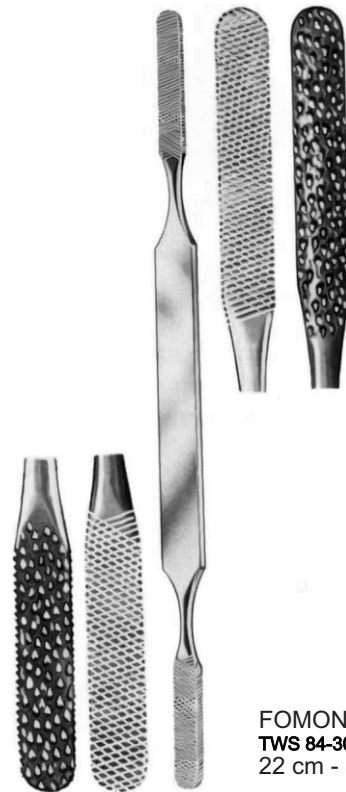

FOMON
TWS 84-3034/25
22 cm - 8 3/4"



TW Surgical

Nasal Files, Nasal Rasps

Nasal files

Nasal rasp

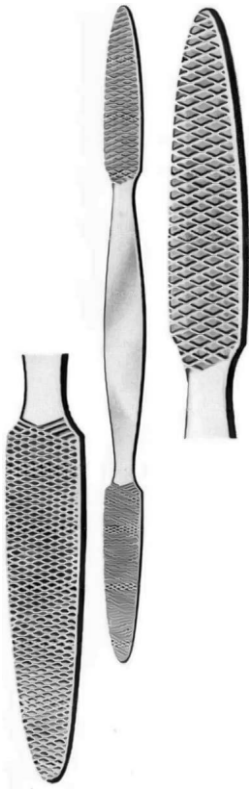

CONVERSE
TWS 84-3034/26
18.5 cm - 7¼"



MASING
TWS 84-3034/27
21 cm - 8¼"



MASING
TWS 84-3034/28
21 cm - 8¼"

Treasure Wright (U.K.) Ltd.

128-160 City Road, London, ECLV 2NX, United Kingdom
info@twrightmedical.com



TW Surgical

Septum Forceps

Septum Straightening Forceps



WALSHAM
"UNIVERSAL"
TWS 84-3034/31
23 cm - 9"

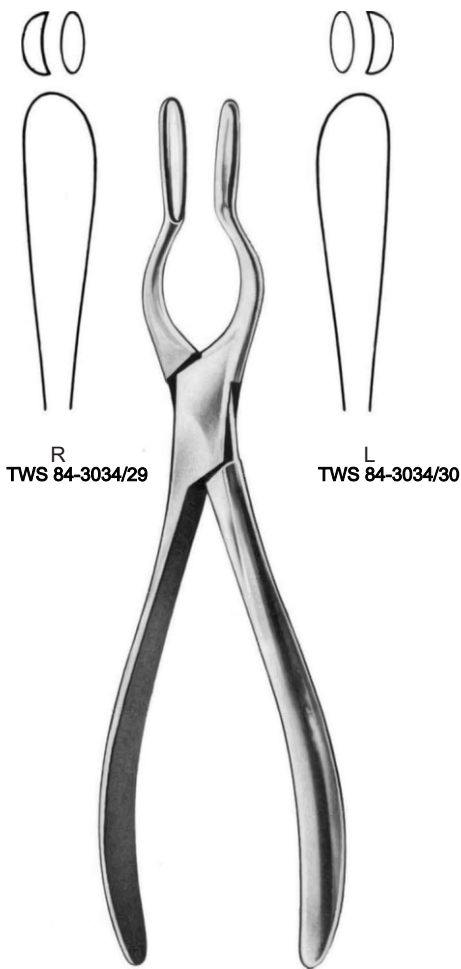

R
TWS 84-3034/29

L
TWS 84-3034/30

WALSHAM
TWS 84-3034/32
R.23 cm - 9"

WALSHAM
TWS 84-3034/33
L.23 cm - 9"

Dismantleable

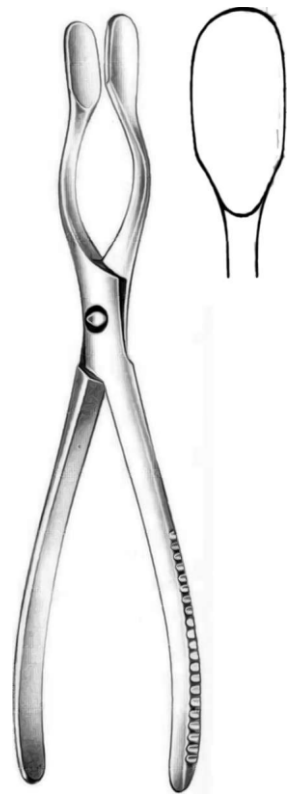

COTTLE-FOMON
TWS 84-3034/34
21 cm - 8¼"

Treasure Wright (U.K.) Ltd.

128-160 City Road, London, EC1V 2NX, United Kingdom
info@twrightmedical.com

Nasal Saddle Punches

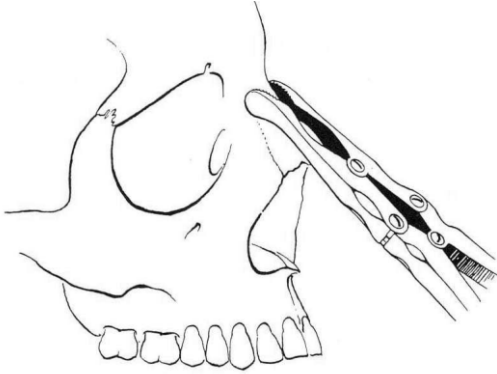

Used to reduce the angle between nose and forehead by delicate biting of the bone.

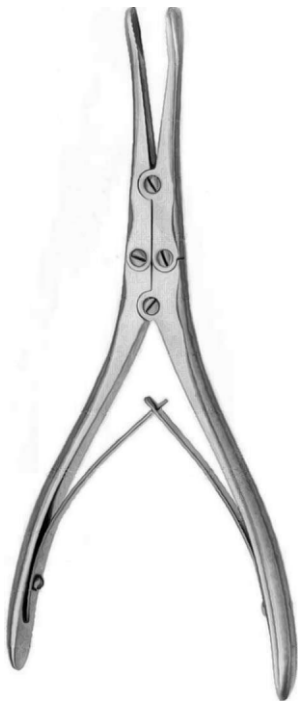

OBWEGESER
18.5 cm - 7 1/4"



TWS 84-3034/35
4 mm

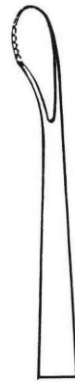

TWS 84-3034/36
6 mm



TWS 84-3034/37
8 mm

Osteotomas, Chisels

"Fishtail"

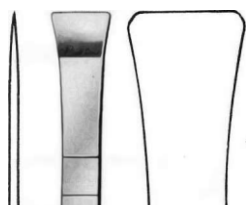

16 mm

Graduated

COTTLE
TWS 84-3034/40
18 cm - 7¼"

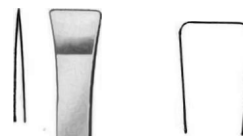

TWS 84-3034/38
10 mm



TWS 84-3034/39
14 mm

RUBIN
18 cm - 7¼"



10 mm

Bone lever and splitting osteotome

COTTLE
TWS 84-3034/44
20 cm - 8"



FANOUS
19.5 cm - 7¾"

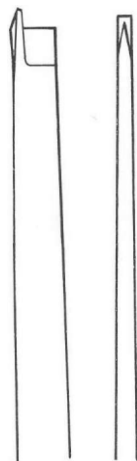

TWS 84-3034/41

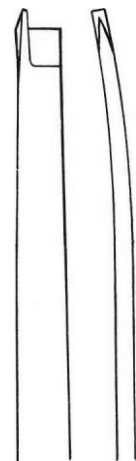

TWS 84-3034/42

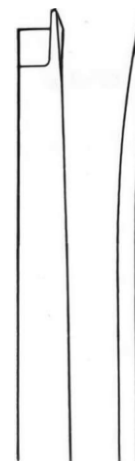

TWS 84-3034/43



TW Surgical

Osteotomes, Chisels

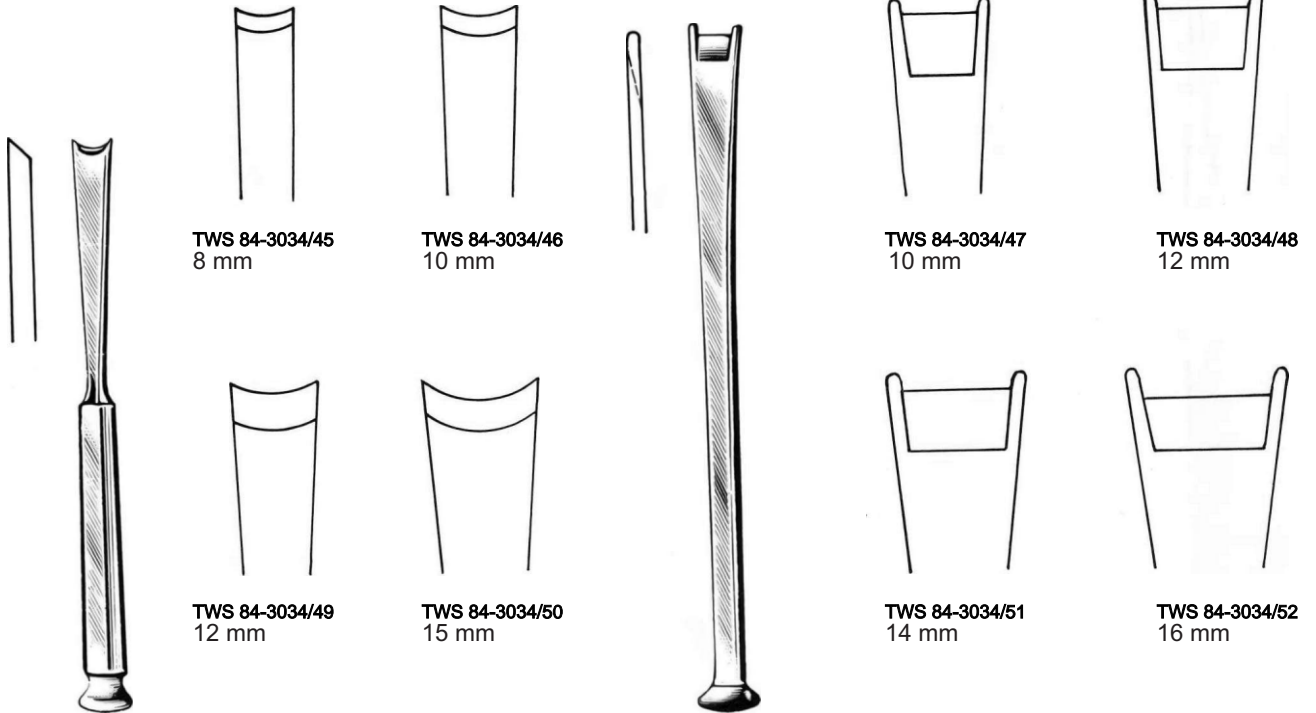

MCINDOE
16 cm - 6¼"

MOBERG
18 cm - 7¼"

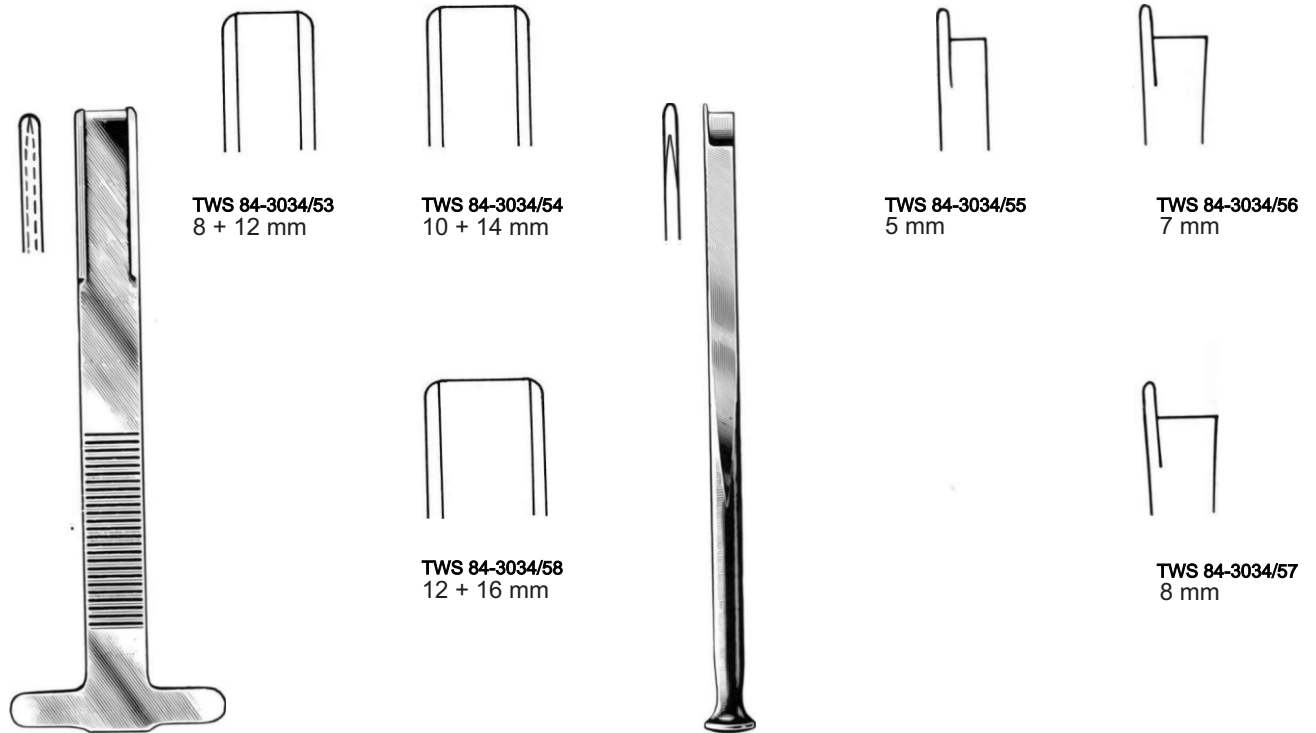

RUBIN
18 cm - 7¼"

FOMON
17 cm - 6¾"

Treasure Wright (U.K.) Ltd.

128-160 City Road, London, EC1V 2NX, United Kingdom
info@twrightmedical.com



TW Surgical

Elevators, Raspatories

Blunt



Elevator for fracture repositioning of the nasal bone

TWS 84-3034/59
17 cm - 6³/₄"

Sharp



Raspatory

CONVERSE
TWS 84-3034/60
18 cm - 7¹/₄"

Blunt



Nasal fracture elevator

BOLES
TWS 84-3034/61
19 cm - 7¹/₂"

Blunt



Septum displacer

GOLDMANN
TWS 84-3034/62
17 cm - 6³/₄"

Treasure Wright (U.K.) Ltd.

128-160 City Road, London, EC1V 2NX, United Kingdom
info@twrightmedical.com

Elevators, Raspatories



Suction elevator

Suction raspatory

Septum elevator

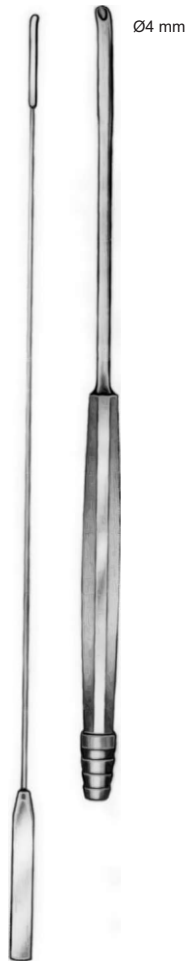

TWS 84-3034/66
21 cm - 8¼"

Malleable sharp



With guide

TWS 84-3034/67
20 cm - 8"



TWS 84-3034/63
2.5 mm



TWS 84-3034/64
3 mm



TWS 84-3034/65
4 mm



COTTLE
16 cm - 6¼"

Rhinoplasty Scissors



O,BRIEN
TWS 84-3034/70
16 cm - 6¼"



COTTLE-MASING
10 cm - 4"



TWS 84-3034/68
Sharp



TWS 84-3034/69
Blunt



LITTLER
TWS 84-3034/71
12 cm - 4¾"

Suture Scissors

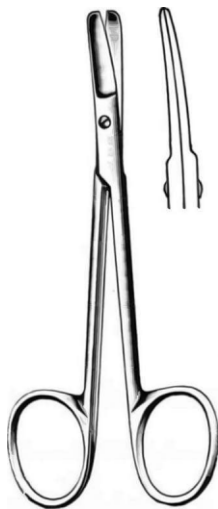

COTTLE "BULLDOG"
TWS 84-3034/72
11.5 cm - 4½"



OBWEGESER
TWS 84-3034/73
18 cm - 7¼"

Undermining scissors

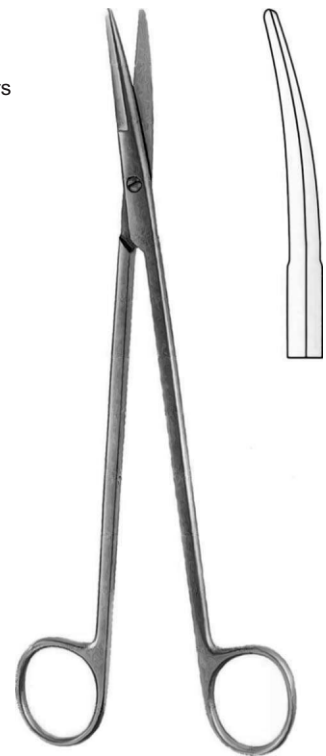

OBWEGESER
TWS 84-3034/74
20 cm - 8"



TW Surgical

Rhinoplasty Scissors

Serrated

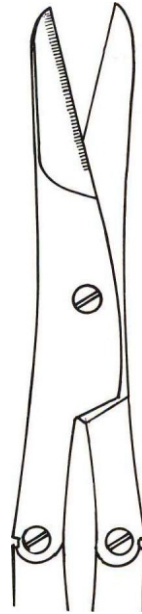

Septum Scissors

CAPLAN
TWS 84-3034/75
20 cm - 8"

Serrated



TWS 84-3034/76

TWS 84-3034/77

TWS 84-3034/78

Nasal Ridge Scissors

OBWEGESER
21 cm - 8 1/4"

Treasure Wright (U.K.) Ltd.

128-160 City Road, London, EC1V 2NX, United Kingdom
info@twrightmedical.com



TW Surgical

Snare Wires, Catgut Loops

Snare wires

For tonsil snares



Coil/10 meters

TWS 84-3034/79 Ø 0.35 mm
TWS 84-3034/80 Ø 0.40 mm
TWS 84-3034/81 Ø 0.45 mm

Standard size

Delivery with 3 wire loops

Delivery with 3 wires preshaped

With catch

With catch



EVES
TWS 84-3034/82
27 cm - 10³/₄"

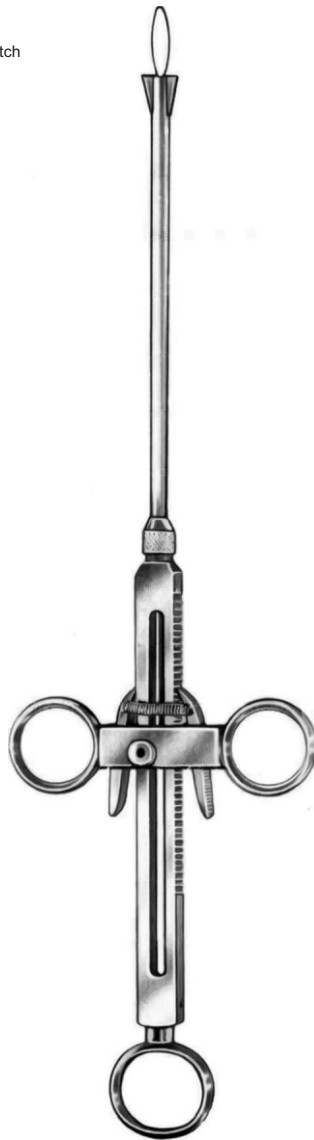

BRUNING
TWS 84-3034/83
29 cm - 11³/₄"

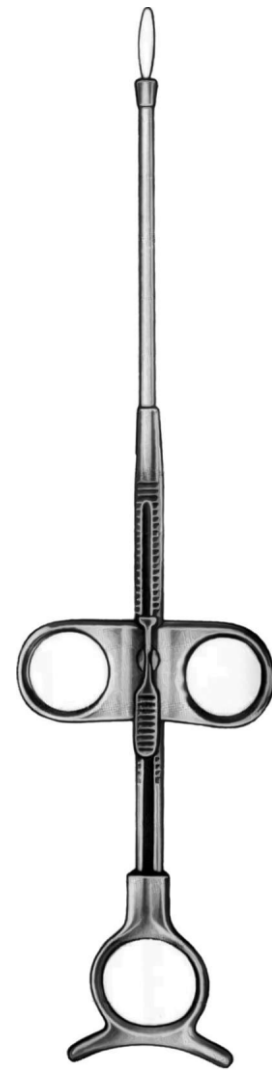

EVES
TWS 84-3034/84
27 cm - 11³/₄"

Treasure Wright (U.K.) Ltd.

128-160 City Road, London, EC1V 2NX, United Kingdom
info@twrightmedical.com

Tonsil Punches

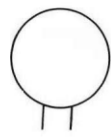

TWS 84-3034/85
Ø 13 mm

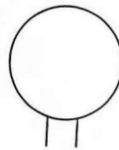

TWS 84-3034/86
Ø 15 mm

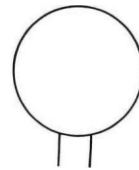

TWS 84-3034/87
Ø 17 mm

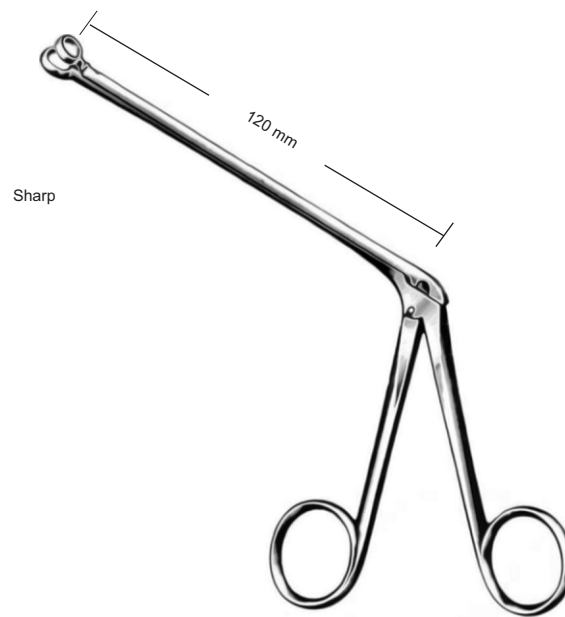

HARTMANN



TW Surgical

Tonsil Seizing Forceps



WHITE
TWS 84-3034/88
18 cm - 7 $\frac{1}{4}$ "



COLVER
TWS 84-3034/90
19 cm - 7 $\frac{1}{2}$ "

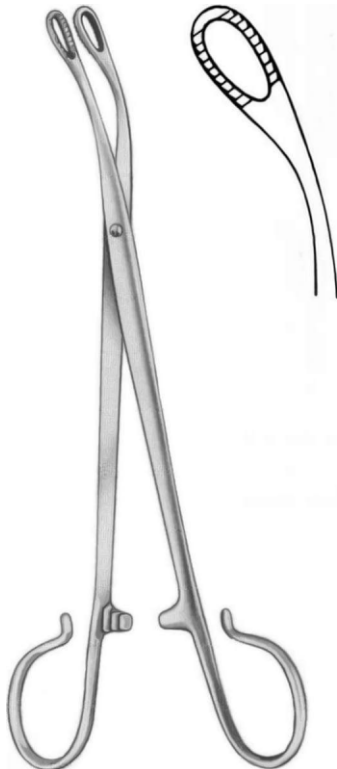

ABRAHAM
TWS 84-3034/89
20.5 cm - 8"

Treasure Wright (U.K.) Ltd.

128-160 City Road, London, EC1V 2NX, United Kingdom
info@twrightmedical.com

Tonsil Seizing Forceps



BLOHMKE
TWS 84-3034/91
21 cm - 8 $\frac{1}{4}$ "

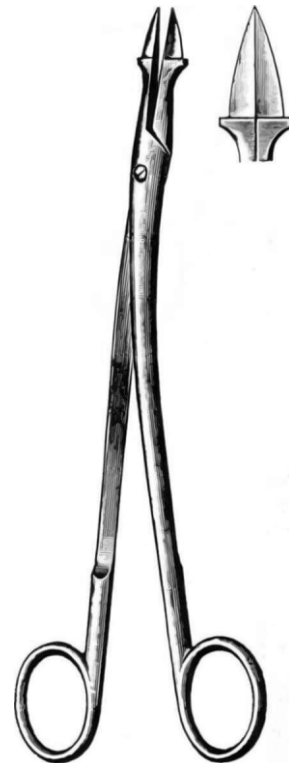

THILENIUS
TWS 84-3034/92
20 cm - 8"



TW Surgical

Tonsil Knives, Tonsil Screws



Reversible, in screwable sheath

FISHER
TWS 84-3034/93
22.5 cm - 9"

ABRAHAM (TYDING)
TWS 84-3034/94
20 cm - 8"

TWS 84-3034/95
21 cm - 8 1/4"
Ø 7 mm

TWS 84-3034/96
10 cm - 4"
Ø 4 mm

Treasure Wright (U.K.) Ltd.

128-160 City Road, London, EC1V 2NX, United Kingdom
info@twrightmedical.com

Tonsil Dissectors

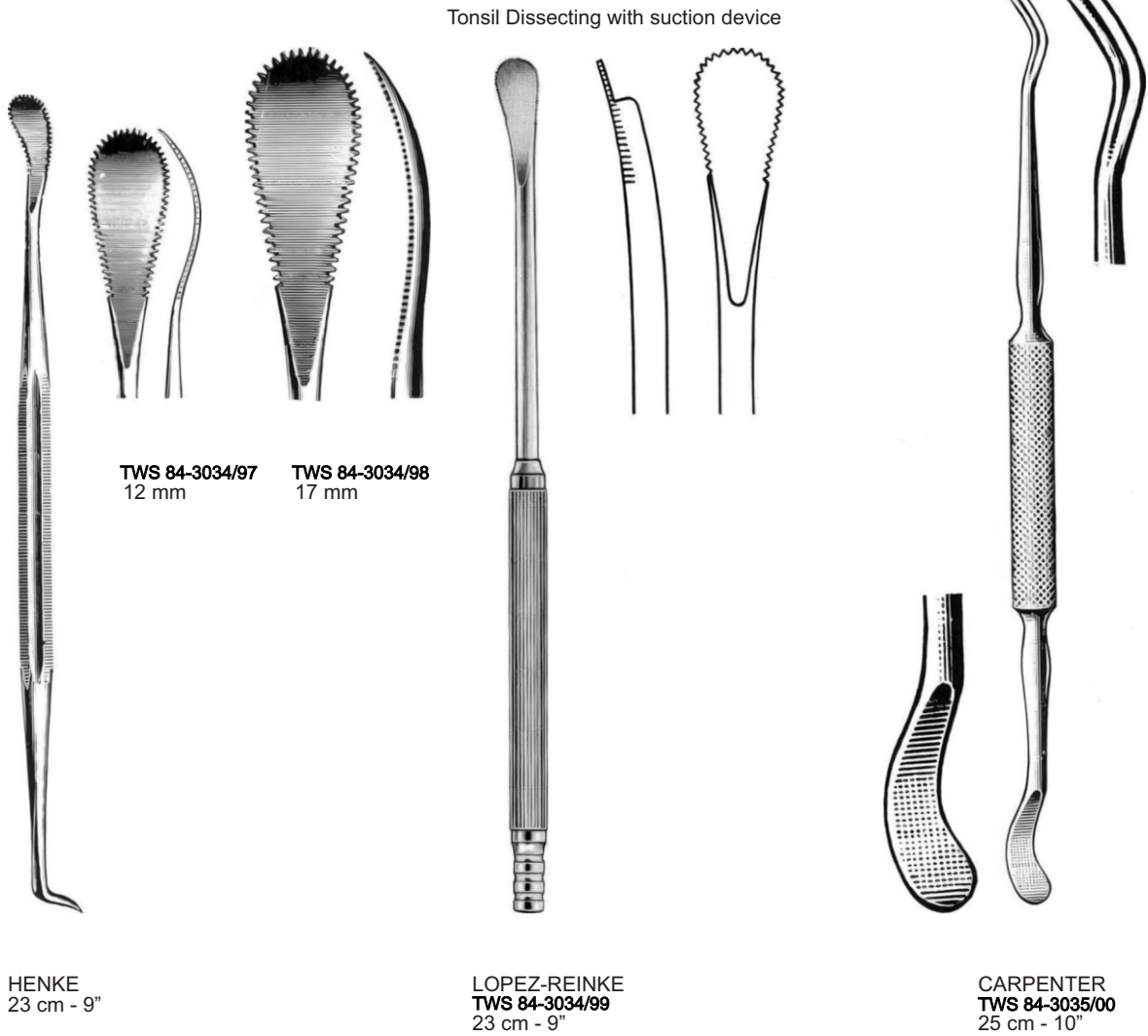



TW Surgical

Tonsil Scissors

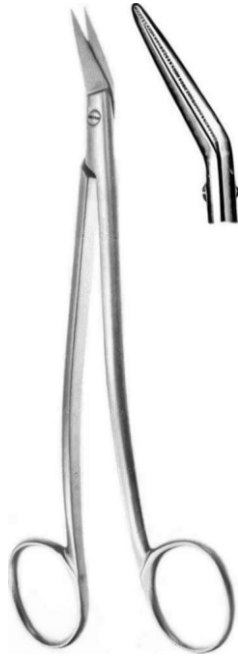

1 Serrated blade

DEAN
TWS 84-3035/01
17 cm - 6 $\frac{3}{4}$ "

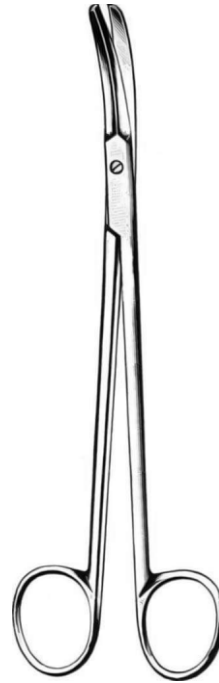

BOETTCHER
TWS 84-3035/04
18 cm - 7 $\frac{1}{4}$ "



PRINCE
TWS 84-3035/02
18 cm - 7 $\frac{1}{4}$ "

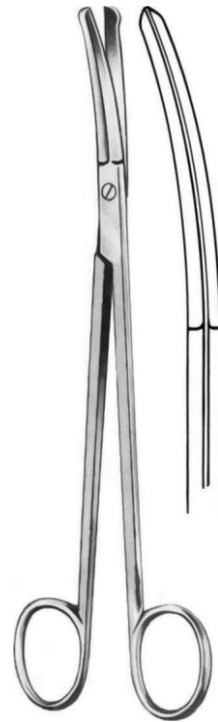

GOOD
TWS 84-3035/03
19 cm - 7 $\frac{1}{2}$ "

Treasure Wright (U.K.) Ltd.

128-160 City Road, London, EC1V 2NX, United Kingdom
info@twrightmedical.com



TW Surgical

Laryngeal Cotton Carriers, Epiglottis Retractor

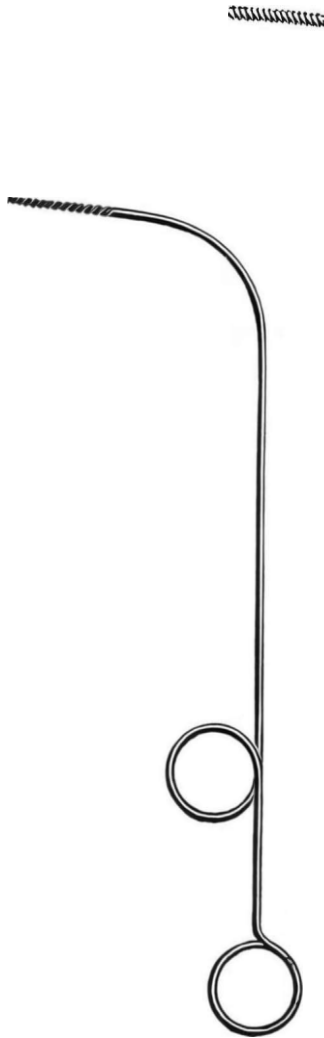

PELTSESON
TWS 84-3035/05
23.5 cm - 9 $\frac{1}{4}$ "

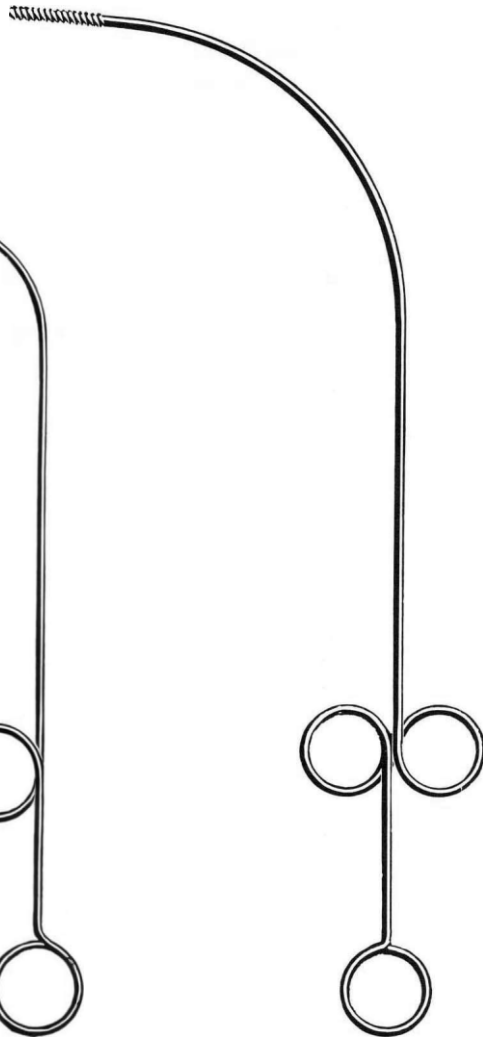

FEIN
TWS 84-3035/06
29 cm - 11 $\frac{3}{4}$ "



REICHERT
TWS 84-3035/07
23 cm - 9"

Treasure Wright (U.K.) Ltd.

128-160 City Road, London, EC1V 2NX, United Kingdom
info@twrightmedical.com

Adenoid Currettes



With basket



TWS 84-3035/08
TWS 84-3035/09
1 - 10mm



TWS 84-3035/13
TWS 84-3035/12
2 - 11mm



TWS 84-3035/16
TWS 84-3035/17
3 - 12mm



TWS 84-3035/10
TWS 84-3035/11
4 - 13mm



TWS 84-3035/14
TWS 84-3035/15
5 - 15mm



TWS 84-3035/18
TWS 84-3035/19
6 - 16mm



BECKMANN
TWS 84-3035/20 # 1
TWS 84-3035/21 # 2
TWS 84-3035/22 # 3
TWS 84-3035/23 # 4
TWS 84-3035/24 # 5
TWS 84-3035/25 # 6
22 cm - 8³/₄"

BECKMANN
TWS 84-3035/26 # 1
TWS 84-3035/27 # 2
TWS 84-3035/28 # 3
TWS 84-3035/29 # 4
TWS 84-3035/30 # 5
TWS 84-3035/31 # 6
22 cm - 8³/₄"

Treasure Wright (U.K.) Ltd.

128-160 City Road, London, ECLV 2NX, United Kingdom
info@twrightmedical.com



TW Surgical

Adenotomes

Included in the consignment: 3 blades of the each size



LA FORCE-MEDICON
 TWS 84-3035/31 # 0
 TWS 84-3035/32 # 1
 TWS 84-3035/33 # 2
 TWS 84-3035/34 # 3
 23.5 cm - 9 1/4"



SHAMBAUGH
 TWS 84-3035/35 # 0
 TWS 84-3035/36 # 1
 TWS 84-3035/37 # 2
 TWS 84-3035/38 # 3
 23.5 cm - 9 1/4"

Replacement blades only for la force and shambaugh adenotome

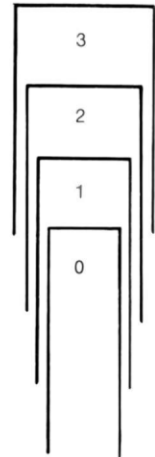
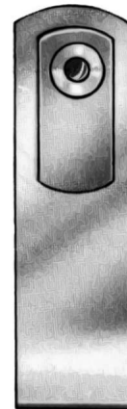

TWS 84-3035/39 # 0 - 10 mm
 TWS 84-3035/40 # 1 - 13 mm
 TWS 84-3035/41 # 2 - 16 mm
 TWS 84-3035/42 # 3 - 19 mm

Treasure Wright (U.K.) Ltd.

128-160 City Road, London, EC1V 2NX, United Kingdom
info@twrightmedical.com

Naso-Pharyngeal Forceps



Sharp

ST. CLAIR-THOMSON
TWS 84-3035/43
18 cm - 7 1/4"



For children

Sharp

JURASZ
TWS 84-3035/44
19 cm - 7 1/2"

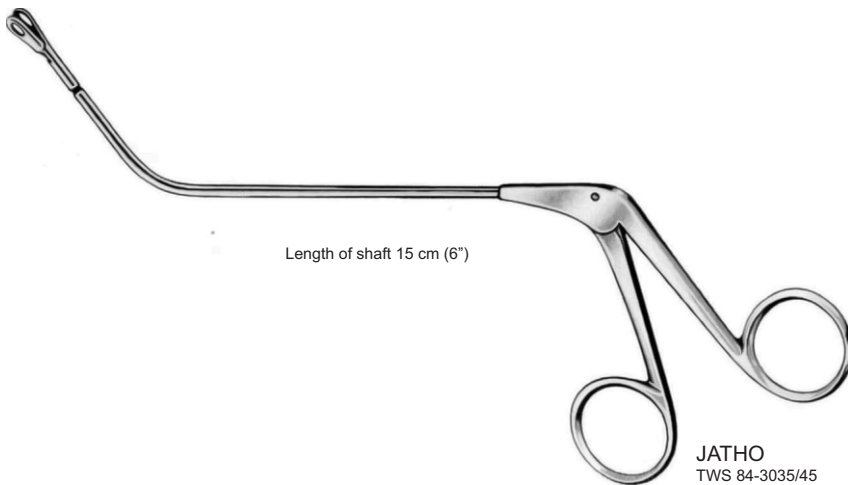

Length of shaft 15 cm (6")

JATHO
TWS 84-3035/45

Treasure Wright (U.K.) Ltd.

128-160 City Road, London, EC1V 2NX, United Kingdom
info@twrightmedical.com



TW Surgical

Naso-Pharyngeal Forceps

Delicate scissors



TWS 84-3035/46
straight



TWS 84-3035/48
angled up



TWS 84-3035/50
Curved to right



TWS 84-3035/47
curved to left



TWS 84-3035/49
angled down



TWS 84-3035/51
straight, horizontally cutting

Flexible working end

Naso-pharyngeal biopsy forceps



TWS 84-3035/52
R
Jaws opening to the right



TWS 84-3035/53
L
Jaws opening to the left



TWS 84-3035/54 # R
TWS 84-3035/55 # L

Treasure Wright (U.K.) Ltd.

128-160 City Road, London, EC1V 2NX, United Kingdom
info@twrightmedical.com

Laryngeal Forceps / Scissors



JACKSON
TWS 84-3035/56
18.5 cm - 7¼"

Laryngeal forceps

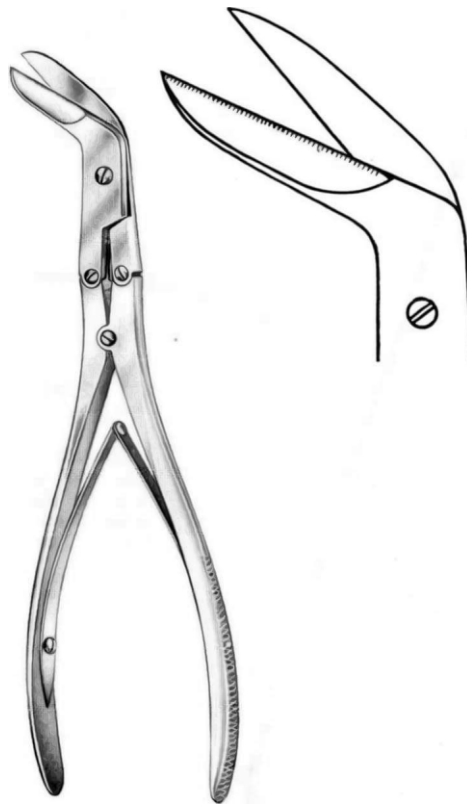

KILLIAN
TWS 84-3035/57
20 cm - 8"

Laryngotomy scissors



TW Surgical

Laryngeal and Bronchoscopic Forceps

Elongation tubes rigid, angled

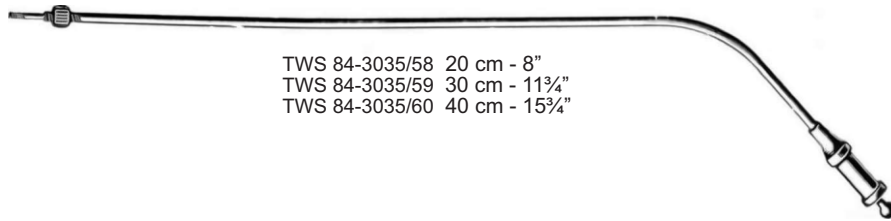

TWS 84-3035/58 20 cm - 8"
TWS 84-3035/59 30 cm - 11³/₄"
TWS 84-3035/60 40 cm - 15³/₄"

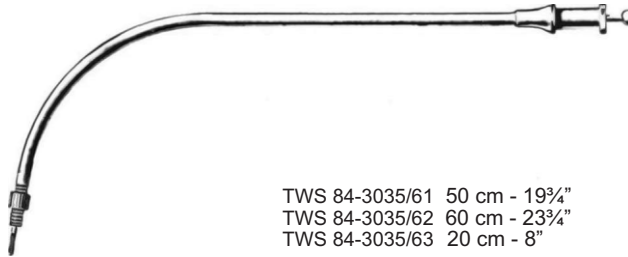

TWS 84-3035/61 50 cm - 19³/₄"
TWS 84-3035/62 60 cm - 23³/₄"
TWS 84-3035/63 20 cm - 8"

Elongation tube rigid, curved

Treasure Wright (U.K.) Ltd.

128-160 City Road, London, EC1V 2NX, United Kingdom
info@twrightmedical.com

Laryngeal and Bronchoscopic Forceps



Laryngeal forceps tips (suitable for elongation tubes)



CORDES (ROSENBERG)
TWS 84-3035/64 # 1-3 mm
TWS 84-3035/65 # 2-4 mm
TWS 84-3035/66 # 3-5 mm



CORDES
TWS 84-3035/69
Ø 4 mm



CORDES
TWS 84-3035/71
Ø 4 mm



CORDES
TWS 84-3035/67 # 1
TWS 84-3035/68 # 2



CORDES
TWS 84-3035/70
5 mm

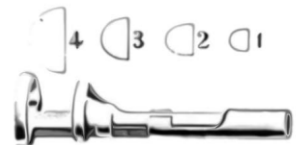

CORDES
TWS 84-3035/72 # 1-3 mm
TWS 84-3035/73 # 2-4 mm
TWS 84-3035/74 # 3-5 mm
TWS 84-3035/75 # 4-8 mm



CORDES
TWS 84-3035/76



EICKEN
SI-17.78



SEIFFERT
SI-18.76



FRANKEL
TWS 84-3035/77



BRUNINGS
SI-17.82 2.5 X 5 mm
SI-17.83 3 X 6 mm



FRANKEL
SI-18.80



BRUNINGS
TWS 84-3035/78 Ø 3 mm
TWS 84-3035/79 Ø 4 mm



KRAUSE
SI-18.84
SI-18.85



SCHEINMANN
TWS 84-3035/80

Treasure Wright (U.K.) Ltd.

128-160 City Road, London, EC1V 2NX, United Kingdom
info@twrightmedical.com



TW Surgical

Laryngeal and Bronchoscopic Forceps

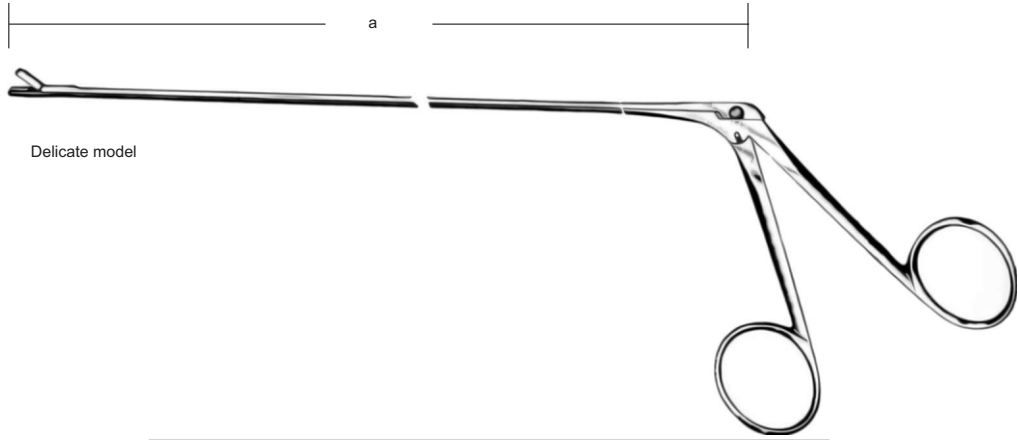

Delicate model

			Ø 2 mm	Ø 2 mm
a				
28 cm	TWS 84-3035/81	TWS 84-3035/83	TWS 84-3035/85	
35 cm	TWS 84-3035/82	TWS 84-3035/84	TWS 84-3035/86	

	PATTERSON			
a				
28 cm	TWS 84-3035/87	TWS 84-3035/89	TWS 84-3035/91	
35 cm	TWS 84-3035/88	TWS 84-3035/90	TWS 84-3035/92	

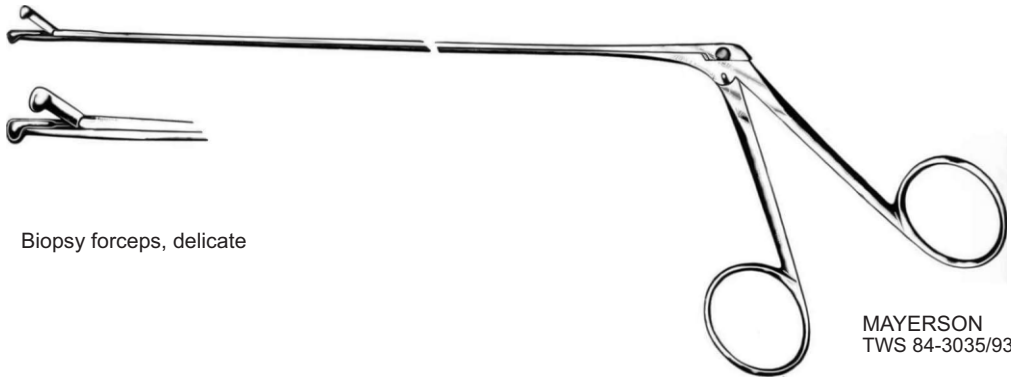

Biopsy forceps, delicate

MAYERSON
TWS 84-3035/93

Treasure Wright (U.K.) Ltd.

128-160 City Road, London, EC1V 2NX, United Kingdom
info@twrightmedical.com

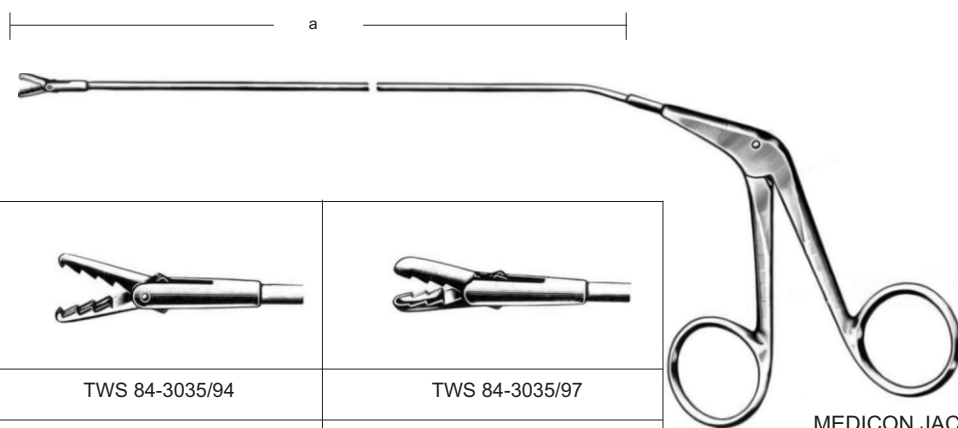

Bronchial-Esophageal Forceps

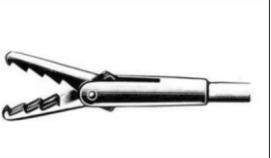
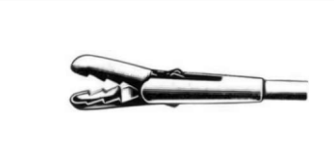

MEDICON JACKSON

Shaft 3mm diam, for use through tubes up from 6 mm diam

a		
35 cm	TWS 84-3035/94	TWS 84-3035/97
45 cm	TWS 84-3035/95	TWS 84-3035/98
55 cm	TWS 84-3035/96	TWS 84-3035/99

a		
35 cm	TWS 84-3036/00	TWS 84-3036/03
45 cm	TWS 84-3036/01	TWS 84-3036/04
55 cm	TWS 84-3036/02	TWS 84-3036/05

a		
35 cm	TWS 84-3036/06	TWS 84-3036/09
45 cm	TWS 84-3036/07	TWS 84-3036/10
55 cm	TWS 84-3036/08	TWS 84-3036/11

a	
35 cm	TWS 84-3036/12
45 cm	TWS 84-3036/13
55 cm	TWS 84-3036/14

Trachea Tubes



International scale of tracheal tube sizes

Fig.	0	1	2	3	4	5	6	7	8	9
mm Ø	4	5	6	7	8	9	10	11	12	13
Charr.	12	15	18	21	24	27	30	33	36	39
Length mm	45	50	55	60	65	70	75	80	85	90

Tracheal tube, standard pattern



German silver

Silver Plated

LUER

TWS 84-3036/15	Fig. 0 - 4 mm Ø	TWS 84-3036/25
TWS 84-3036/16	Fig. 1 - 5 mm Ø	TWS 84-3036/26
TWS 84-3036/17	Fig. 2 - 6 mm Ø	TWS 84-3036/27
TWS 84-3036/18	Fig. 3 - 7 mm Ø	TWS 84-3036/28
TWS 84-3036/19	Fig. 4 - 8 mm Ø	TWS 84-3036/29
TWS 84-3036/20	Fig. 5 - 9 mm Ø	TWS 84-3036/30
TWS 84-3036/21	Fig. 6 - 10 mm Ø	TWS 84-3036/31
TWS 84-3036/22	Fig. 7 - 11 mm Ø	TWS 84-3036/32
TWS 84-3036/23	Fig. 8 - 12 mm Ø	TWS 84-3036/33
TWS 84-3036/24	Fig. 9 - 13 mm Ø	TWS 84-3036/34

Treasure Wright (U.K.) Ltd.

128-160 City Road, London, EC1V 2NX, United Kingdom
 info@twrightmedical.com



TW Surgical

Tracheotomy Instruments

Tracheal retractors



BOSE
TWS 84-3036/35
7 cm - 2³/₄"

Tracheal dilators



TROUSSEAU
TWS 84-3036/36
12 cm - 4³/₄"

For children

TROUSSEAU
TWS 84-3036/37
14 cm - 5¹/₂"

For adults

Tracheal artery forceps

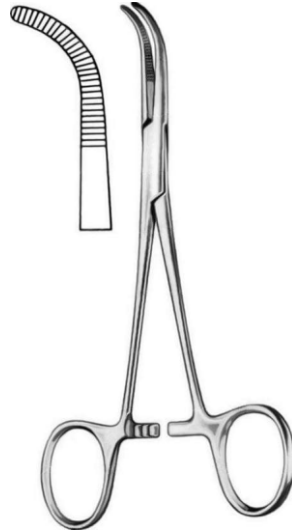

JACKSON
TWS 84-3036/38
14.5 cm - 5³/₄"

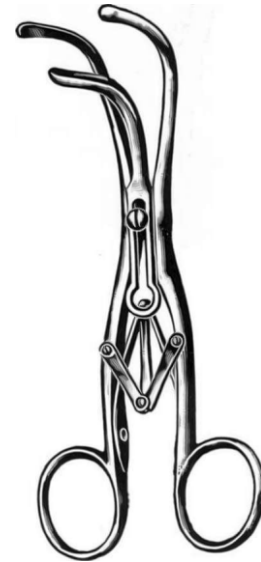

LABORDE
TWS 84-3036/39
15 cm - 6"

For adults

LABORDE
TWS 84-3036/40
13 cm - 5¹/₈"

For children

Treasure Wright (U.K.) Ltd.

128-160 City Road, London, EC1V 2NX, United Kingdom
info@twrightmedical.com

Thyroidectomy Instruments



Thyroid dissector

Thyroid dissecting scissors

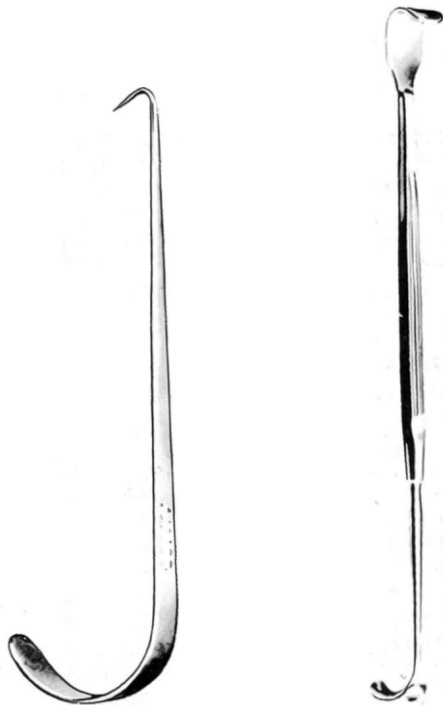

JACKSON
TWS 84-3036/41
13 cm - 5¼"

LUCKENS
TWS 84-3036/42

10 mm
wide
Breit

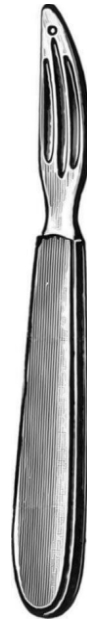

KOCHER
TWS 84-3036/43
15 cm - 6"

12 mm
wide
Breit



KOCHER
TWS 84-3036/44
16.5 cm - 6½"

SCHOEMAKER
TWS 84-3036/45
15 cm - 6"

Goiter forceps



Sharp

LOVELACE
TWS 84-3036/46
15 cm - 6"



Sharp

LAHEY
TWS 84-3036/47
15 cm - 6"



TW Surgical

Tracheotomy Instruments

Tracheotomy set

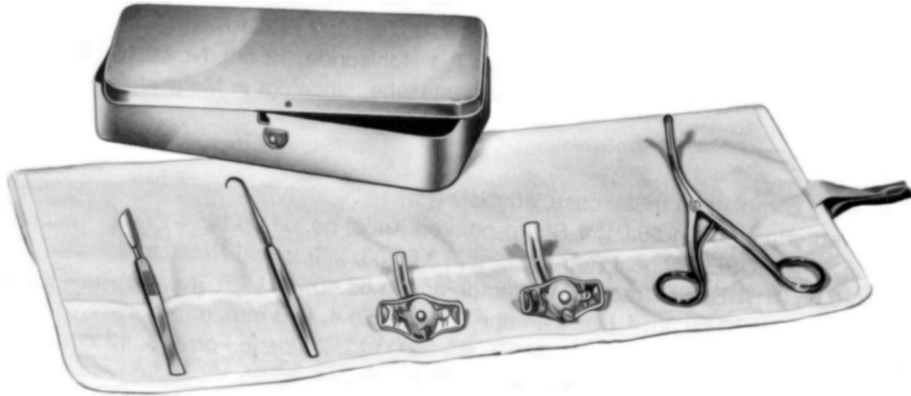

TWS 84-3036/48

Tracheotomy set no.II, complete in metal case, consisting of:
1 scalpel knife, 1 tracheal retractor, sharp-pointed, 1 trousseau tracheal dilator,
1 luer tracheal tube size 2, \varnothing 8 mm, of nickel-silver, in sterilizable canvas roll, in
metal case 200 x 100 x 30mm.

Treasure Wright (U.K.) Ltd.

128-160 City Road, London, EC1V 2NX, United Kingdom
info@twrightmedical.com

Endolaryngeal microsurgery

Working length 22 cm (8 3/4")

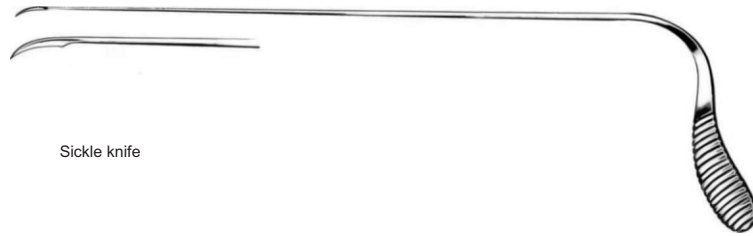

Sickle knife

JAKO
TWS 84-3036/49

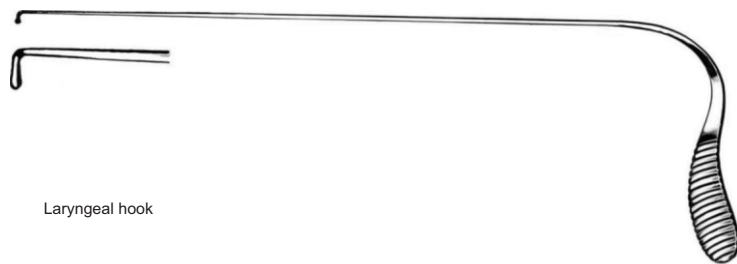

Laryngeal hook

JAKO
TWS 84-3036/50



TW Surgical

Instruments for Oral Endoscopy

Working length 24 cm (9 1/2")

Endolaryngeal microsurgery



Sickle knife

TWS 84-3036/51

Instrument inserts



Laryngeal knife

TWS 84-3036/52



Laryngeal hook

TWS 84-3036/53



Round edge knife

TWS 84-3036/54



Laryngeal hook

TWS 84-3036/55



Round edge knife

TWS 84-3036/56



Laryngeal hook

TWS 84-3036/57



round edge knife

TWS 84-3036/58



Laryngeal hook

TWS 84-3036/60



Laryngeal probe

TWS 84-3036/59



Elevator, blunt

TWS 84-3036/61

Treasure Wright (U.K.) Ltd.

128-160 City Road, London, EC1V 2NX, United Kingdom
info@twrightmedical.com



TW Surgical

Laryngoscopes

McIntosh Set, with Fiber Optic Illumination



- TWS 84-3036/62 Set of 3 blades No. 2,3,4
- TWS 84-3036/63 Set of 5 blades No. 00,0,1,2,3 (pediatric)
- TWS 84-3036/64 Set of 4 blades No. 0,1,2,3 (pediatric)
- TWS 84-3036/65 Set of 4 blades No. 1,2,3,4
- TWS 84-3036/66 Set of 5 blades No. 0,1,2,3,4

All set include 1 standard F.O. battery handle.
Spare lamps can be ordered separately.

Supplied in hard plastic case.

McIntosh Set, with Fiber Optic Illumination



- TWS 84-3036/67 Set of 3 blades No. 2,3,4
- TWS 84-3036/68 Set of 4 blades No. 0,1,2,3 (pediatric)
- TWS 84-3036/69 Set of 4 blades No. 1,2,3,4
- TWS 84-3036/70 Set of 5 blades No. 0,1,2,3,4

All set include 1 standard F.O. battery handle.
Spare lamps can be ordered separately.

Supplied in hard plastic case.

Treasure Wright (U.K.) Ltd.

128-160 City Road, London, EC1V 2NX, United Kingdom
info@twrightmedical.com

Laryngoscopes

Wis-Foregger Set, with Standard Illumination



- TWS 84-3036/71 Set of 3 blades No. 2,3,4
- TWS 84-3036/72 Set of 5 blades No. 00,0,1,2,3 (pediatric)
- TWS 84-3036/73 Set of 4 blades No. 0,1,2,3 (pediatric)
- TWS 84-3036/74 Set of 4 blades No. 1,2,3,4
- TWS 84-3036/75 Set of 5 blades No. 0,1,2,3,4

All set include 1 standard battery handle.
Spare lamps can be ordered separately.

Supplied in hard plastic case.

Wis-Foregger Set, with Fiber Optic Illumination with Interchangeable, Fiberoptic Channels



- TWS 84-3036/76 Set of 3 blades No. 2,3,4
- TWS 84-3036/77 Set of 4 blades No. 0,1,2,3 (pediatric)
- TWS 84-3036/78 Set of 4 blades No. 1,2,3,4
- TWS 84-3036/79 Set of 5 blades No. 0,1,2,3,4

All set include 1 F.O. battery handle.
Spare lamps can be ordered separately.

Supplied in hard plastic case.

Treasure Wright (U.K.) Ltd.



TW Surgical

Laryngoscopes



TWS 84-3036/90

McIntosh Blades, with Fiber Optic Illumination
Intergrated Fiber Optic Channels.

Item No	Fig	Size	For
TWS 84-3036/80	1	70 mm	Infants
TWS 84-3036/81	2	90 mm	Children
TWS 84-3036/82	3	110 mm	Adults, Medium
TWS 84-3036/83	4	130 mm	Adults, Large



TWS 84-3036/91

Wis-Foregger Blades, with Standard Illumination

Item No	Fig	Size	For
TWS 84-3036/85	0	55 mm	Premature babies
TWS 84-3036/86	1	70 mm	Infants
TWS 84-3036/87	2	90 mm	Children
TWS 84-3036/88	3	110 mm	Adults, Medium
TWS 84-3036/89	4	135 mm	Adults, Large

Treasure Wright (U.K.) Ltd.

128-160 City Road, London, EC1V 2NX, United Kingdom
info@twrightmedical.com



TW Surgical

Laryngoscopes



TWS 84-3036/92

McIntosh Blades, with Fiber Optic Illumination
Integrated Fiber Optic Channels.

Item No	Fig	Size	For
TWS 84-3036/93	1	70 mm	Infants
TWS 84-3036/94	2	90 mm	Children
TWS 84-3036/95	3	110 mm	Adults, Medium
TWS 84-3036/96	4	130 mm	Adults, Large



TWS 84-3036/97

Wis-Foregger Blades, with Standard Illumination

Item No	Fig	Size	For
TWS 84-3036/98	0	55 mm	Premature babies
TWS 84-3036/99	1	70 mm	Infants
TWS 84-3037/00	2	90 mm	Children
TWS 84-3037/01	3	110 mm	Adults, Medium
TWS 84-3037/02	4	135 mm	Adults, Large

Treasure Wright (U.K.) Ltd.

128-160 City Road, London, EC1V 2NX, United Kingdom
info@twrightmedical.com

Laryngoscopes



TWS 84-3037/03

Miller Blades, with Fiber Optic Illumination
Intercangeable, Fiber Optic Channel

Item No	Fig	Size	For
TWS 84-3037/04	00	45 mm	Premature babies
TWS 84-3037/05	0	55 mm	Infants
TWS 84-3037/06	1	80 mm	Children
TWS 84-3037/07	2	130 mm	Adults, Medium
TWS 84-3037/08	3	170 mm	Adults, Large
TWS 84-3037/09	4	180 mm	Adults, Extra Large

Professional TeleTip
Laryngoscope For Difficult Intubation

TWS 84-3037/10

Professional TeleTip is a Macintosh Laryngoscope blade with an adjustable distal tip, which is controlled by a lever to lift epiglottis during intubation.

It gives a clear view of vocal chords.
Un-necessary pressure on tongue and contact with upper teeth is thus avoided.

- Completely autoclavable
- High quality steel construction
- Fits standard F.O. Handles
- Supplied in hard or soft case.



Treasure Wright (U.K.) Ltd.



TW Surgical

Laryngoscopes

Halogen Lamps



TWS 84-3037/11
Small, Set of 8



TWS 84-3037/13
Large, Set of 6



TWS 84-3037/12

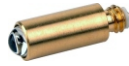

TWS 84-3037/14



TWS 84-3037/15



TWS 84-3037/16



TWS 84-3037/17



TWS 84-3037/18



TWS 84-3037/19

Treasure Wright (U.K.) Ltd.

128-160 City Road, London, EC1V 2NX, United Kingdom
info@twrightmedical.com



TW Surgical

Mouth Gags

Automatic adjusting ratchet

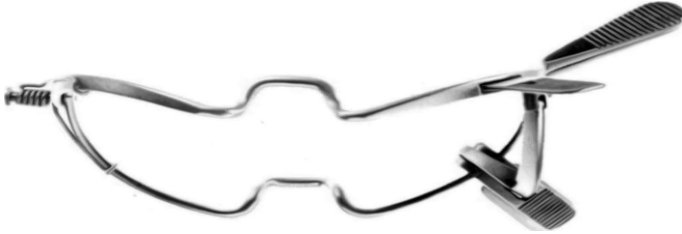

PROFESSIONAL
 TWS 84-3037/20 9 cm - 3½"
 TWS 84-3037/21 11 cm - 4¾"
 TWS 84-3037/22 13 cm - 5¼"
 TWS 84-3037/23 15 cm - 6"



SEEMANN-SEIFFERT
 TWS 84-3037/24 11 cm - 4¾"
 TWS 84-3037/25 13 cm - 5¼"

Dimensions = effective width



JENNINGS
 PROFESSIONAL
 TWS 84-3037/26

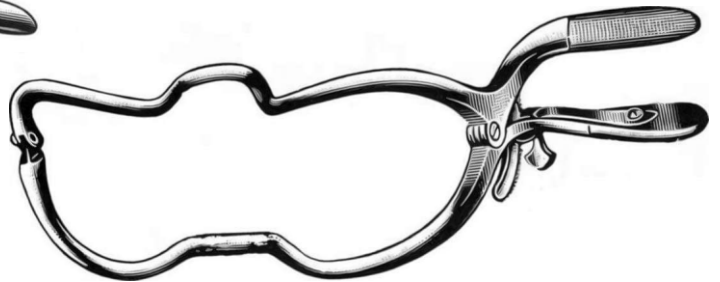

JENNINGS
 TWS 84-3037/27 9 cm - 3½"
 TWS 84-3037/28 11 cm - 4¾"
 TWS 84-3037/29 13 cm - 5¼"
 TWS 84-3037/30 15 cm - 6"



WHITEHEAD
 TWS 84-3037/31 9 cm - 3½"
 TWS 84-3037/32 11 cm - 4¾"
 TWS 84-3037/33 13 cm - 5¼"
 TWS 84-3037/34 15 cm - 6"

Treasure Wright (U.K.) Ltd.

128-160 City Road, London, EC1V 2NX, United Kingdom
info@twrightmedical.com

Mouth Gags

Mouth openers

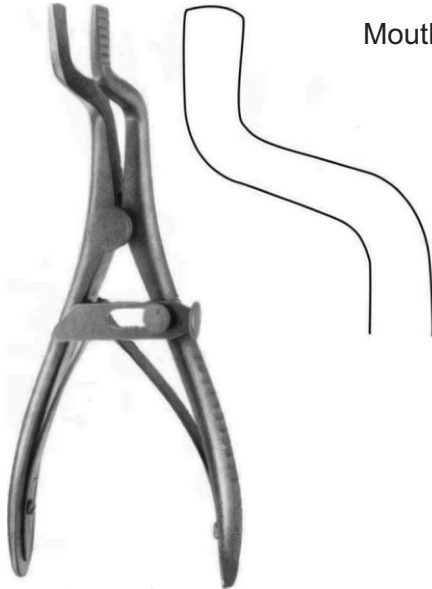

OBWEGESER-ROSER
TWS 84-3037/35
16 cm - 6 1/4"

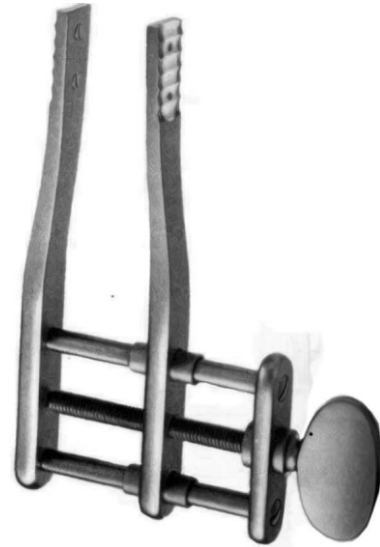

OBWEGESER
TWS 84-3037/36
12.5 cm - 5"



DENHART
TWS 84-3037/39
13 cm - 5 1/4"



FERGUSSON-ACKLAND
TWS 84-3037/40
20 cm - 8"



TWS 84-3037/37
For children

TWS 84-3037/38
For adults

MASON-ACKLAND
TWS 84-3037/41 14 cm - 5 1/2"
TWS 84-3037/42 20 cm - 8"

Tongue Spatulas

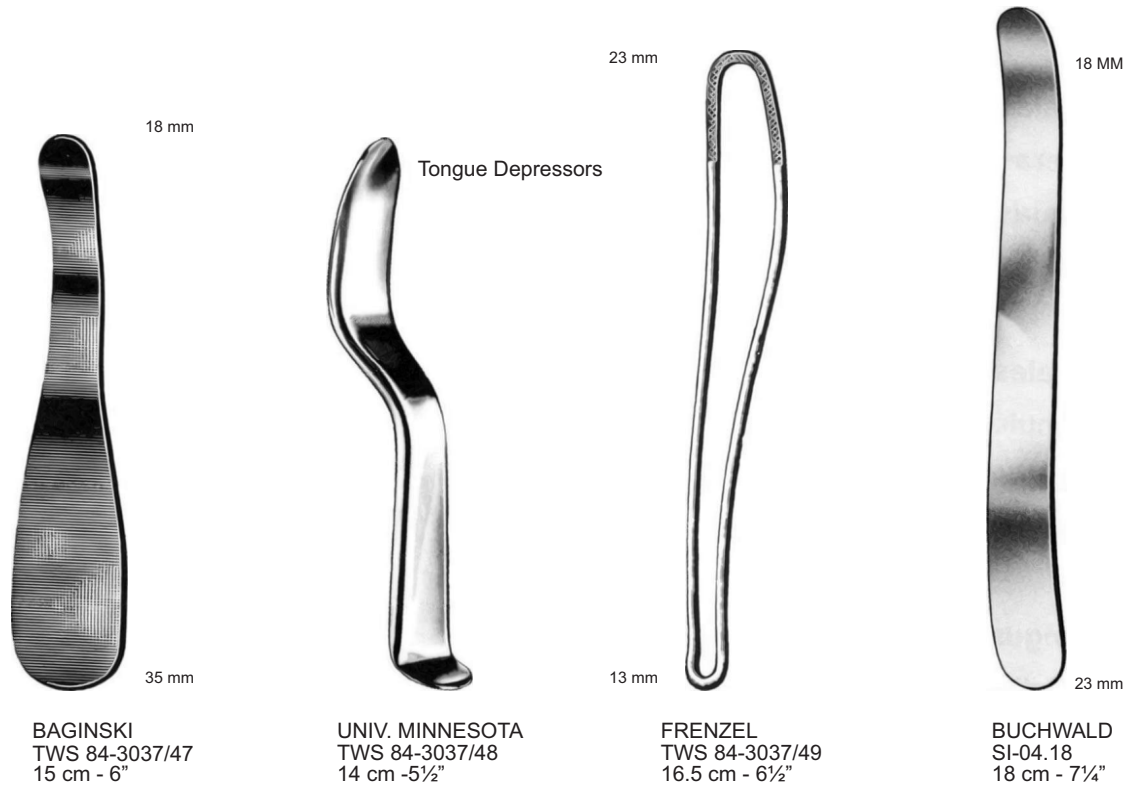
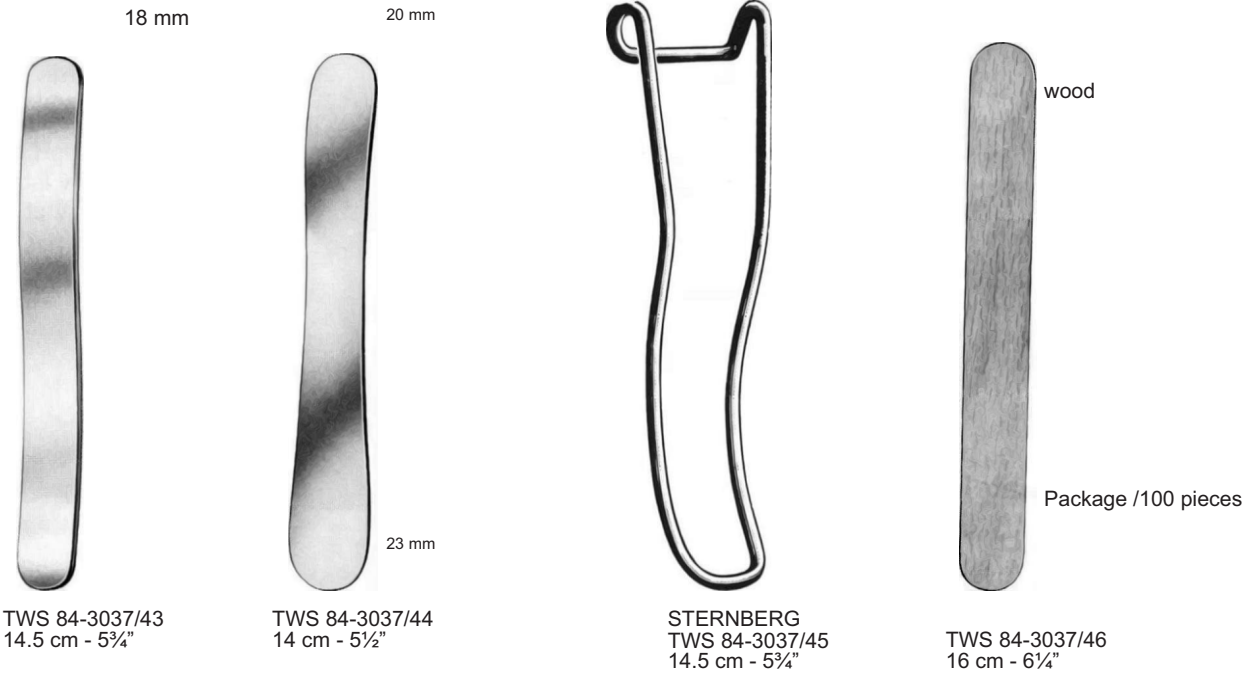

Treasure Wright (U.K.) Ltd.

128-160 City Road, London, EC1V 2NX, United Kingdom
info@twrightmedical.com



TW Surgical

Tongue Spatulas

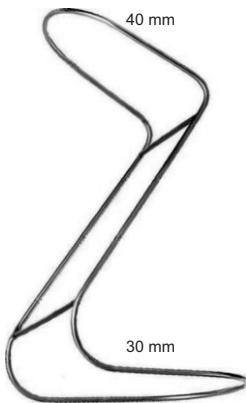

OBWEGESER
TWS 84-3037/50
10 cm - 4"



SHUMAN
TWS 84-3037/51
19 cm - 7½"



TWS 84-3037/52

Treasure Wright (U.K.) Ltd.

128-160 City Road, London, EC1V 2NX, United Kingdom
info@twrightmedical.com



TW
Surgical

Treasure Wright (U.K.) Ltd.

**Address: 128-160 , City Road,
London EC1V 2NX. United Kingdom**

www.twrightmedical.com

info@twrightmedical.com



TW Surgical



**UK
CA CE**