



**TW**  
Surgical

# DENTAL



**UK  
CA** **CE**



TW Surgical

**Treasure Wright (U.K.) Ltd.**



[www.twrightmedical.com](http://www.twrightmedical.com)



[info@twrightmedical.com](mailto:info@twrightmedical.com)



TW Surgical

## Extracting Forceps “English Pattern”



TWS 84-3000/03  
Fig. 4  
lower incisor



TWS 84-3000/01  
Fig. 4  
lower incisor



TWS 84-3000/02  
Fig. 8  
lower premolar



TWS 84-3000/04  
Fig. 8  
lower premolars

Treasure Wright (U.K.) Ltd.

128-160 City Road, London, EC1V 2NX, United Kingdom  
info@twrightmedical.com



TW Surgical

## Extracting Forceps “English Pattern”



TWS 84-3000/08  
Fig. 1  
upper centrals & canines



TWS 84-3000/05  
Fig. 2  
upper laterals & canines



TWS 84-3000/06  
Fig. 3  
upper incisors & canines



TWS 84-3000/07  
Fig. 4  
upper incisors & canines



TWS 84-3000/09  
Fig. 7  
upper premolars



TWS 84-3000/10  
Fig. 8  
lower premolars



TWS 84-3000/11  
Fig. 13  
lower premolars

Treasure Wright (U.K.) Ltd.

128-160 City Road, London, EC1V 2NX, United Kingdom  
info@twrightmedical.com



TW Surgical

## Extracting Forceps “English Pattern”



TWS 84-3000/14  
Fig. 13S  
lower premolars  
for children.

TWS 84-3000/15  
Fig. 17  
upper molars, right

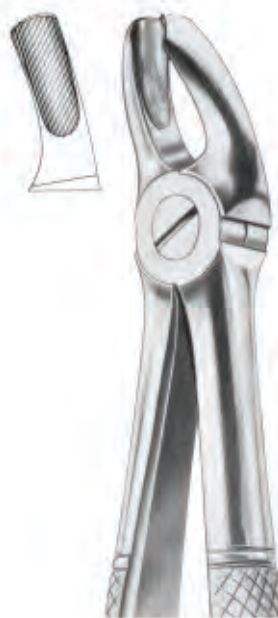

TWS 84-3000/12  
Fig. 18  
upper molars, left



TWS 84-3000/13  
Fig. 18A  
upper molars



TWS 84-3000/16  
Fig. 18B  
upper molars

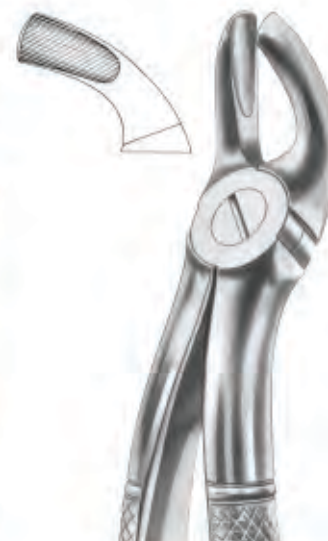

TWS 84-3000/17  
Fig. 19  
upper third molars

Treasure Wright (U.K.) Ltd.

128-160 City Road, London, EC1V 2NX, United Kingdom  
info@twrightmedical.com



TW Surgical

## Extracting Forceps “English Pattern”



TWS 84-3000/21  
Fig. 20  
upper third molars

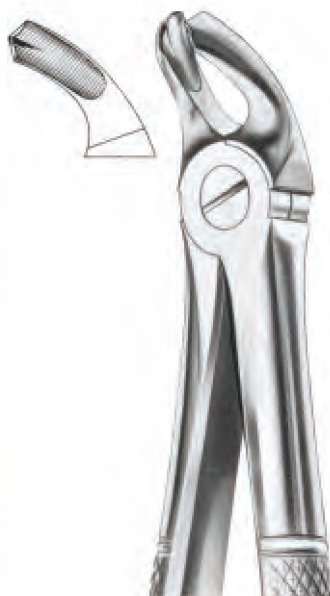

TWS 84-3000/18  
Fig. 21  
lower molars



TWS 84-3000/19  
Fig. 22  
lower molars



TWS 84-3000/20  
Fig. 22S  
lower molars  
for children

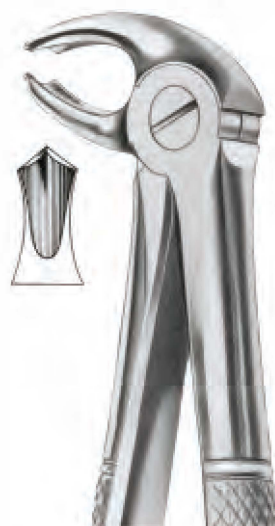

TWS 84-3000/22  
Fig. 22G  
lower molars



TWS 84-3000/23  
Fig. 23  
lower molars right

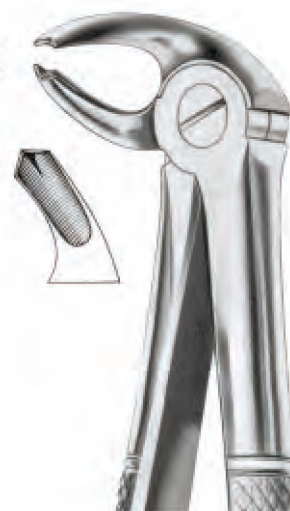

TWS 84-3000/24  
Fig. 24  
lower molars left

Treasure Wright (U.K.) Ltd.

128-160 City Road, London, EC1V 2NX, United Kingdom  
info@twrightmedical.com



TW Surgical

## Extracting Forceps “English Pattern”

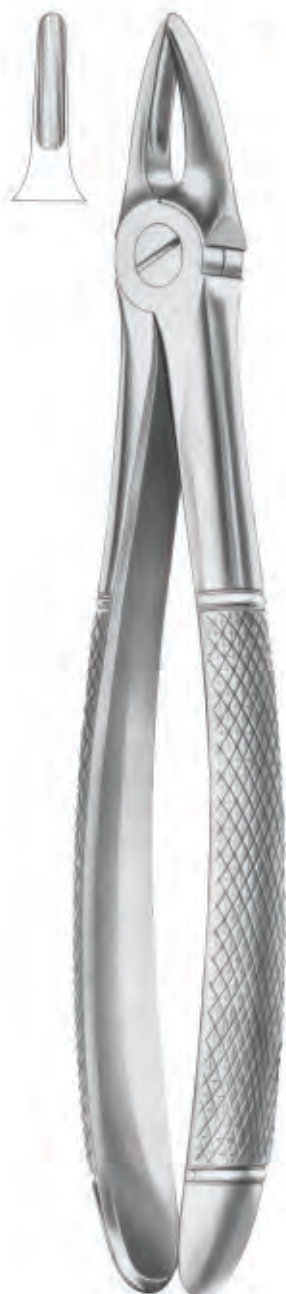

TWS 84-3000/27  
Fig. 29  
upper roots



TWS 84-3000/25  
Fig. 29S  
upper roots for children

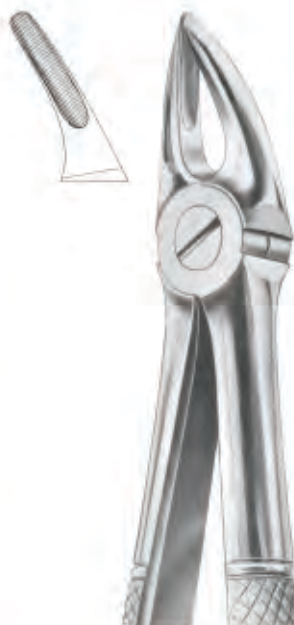

TWS 84-3000/26  
Fig. 30  
upper roots



TWS 84-3000/30  
Fig. 30S  
upper roots  
for children

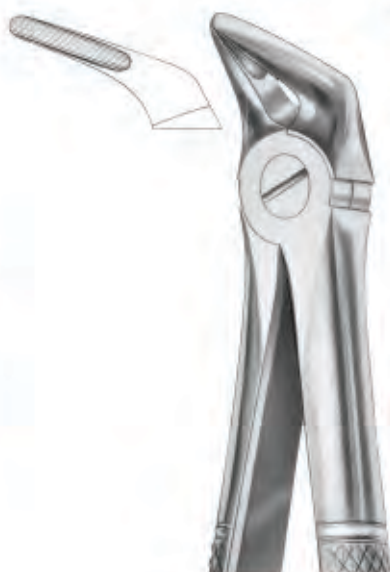

TWS 84-3000/28  
Fig. 31  
lower roots



TWS 84-3000/29  
Fig. 32  
lower molars

Treasure Wright (U.K.) Ltd.

128-160 City Road, London, EC1V 2NX, United Kingdom  
info@twrightmedical.com



TW Surgical

## Extracting Forceps “English Pattern”

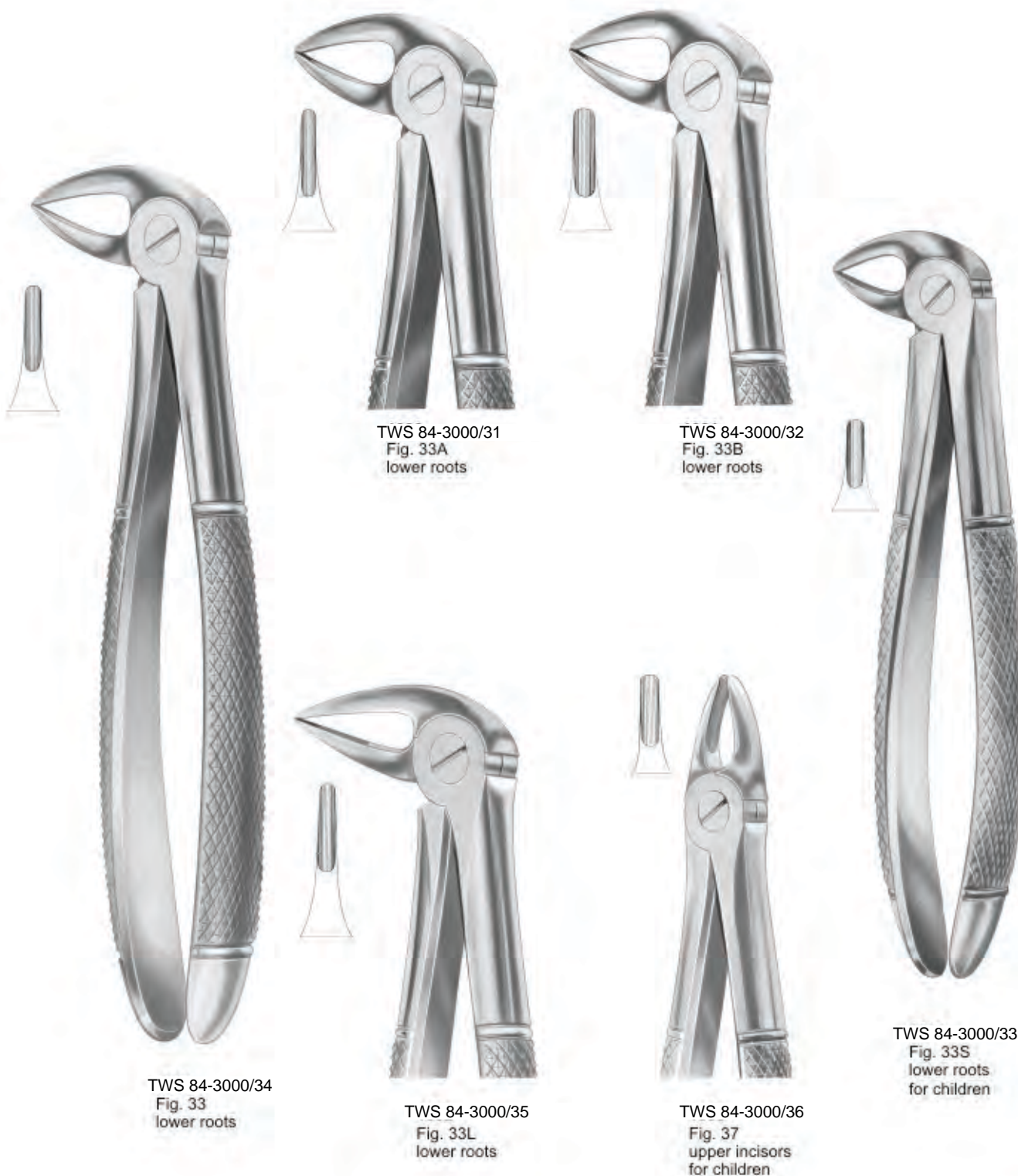

Treasure Wright (U.K.) Ltd.

128-160 City Road, London, EC1V 2NX, United Kingdom  
info@twrightmedical.com



TW Surgical

## Extracting Forceps “English Pattern”



TWS 84-3000/39  
Fig. 38  
lower incisors &  
canines for children



TWS 84-3000/37  
Fig. 39  
upper molars  
for children



TWS 84-3000/38  
Fig. 39R  
upper molars right  
for children



TWS 84-3000/42  
Fig. 39L  
upper molars left  
for children



TWS 84-3000/40  
Fig. 39A  
upper molars  
for children



TWS 84-3000/41  
Fig. 40  
lower molars  
for children

Treasure Wright (U.K.) Ltd.

128-160 City Road, London, EC1V 2NX, United Kingdom  
info@twrightmedical.com



TW Surgical

## Extracting Forceps “English Pattern”



TWS 84-3000/45  
Fig. 41  
upper roots

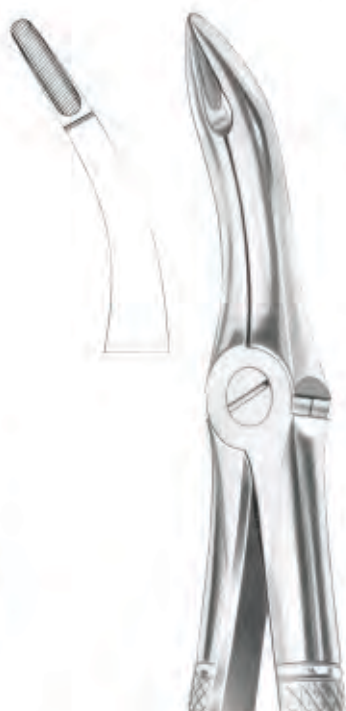

TWS 84-3000/43  
Fig. 44  
upper roots

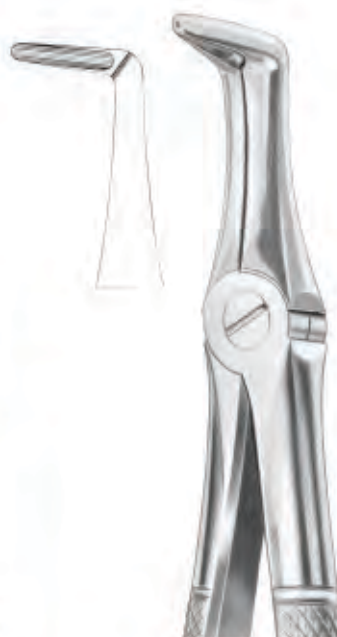

TWS 84-3000/44  
Fig. 45  
lower roots



TWS 84-3000/48  
Fig. 50  
upper roots

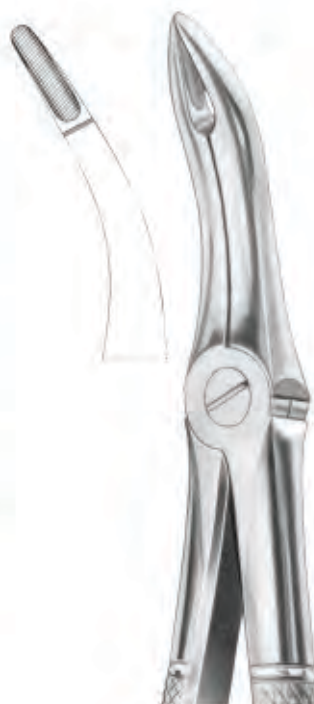

TWS 84-3000/47  
Fig. 48  
lower roots



TWS 84-3000/46  
Fig. 49  
upper roots

Treasure Wright (U.K.) Ltd.

128-160 City Road, London, EC1V 2NX, United Kingdom  
info@twrightmedical.com



TW Surgical

## Extracting Forceps “English Pattern”

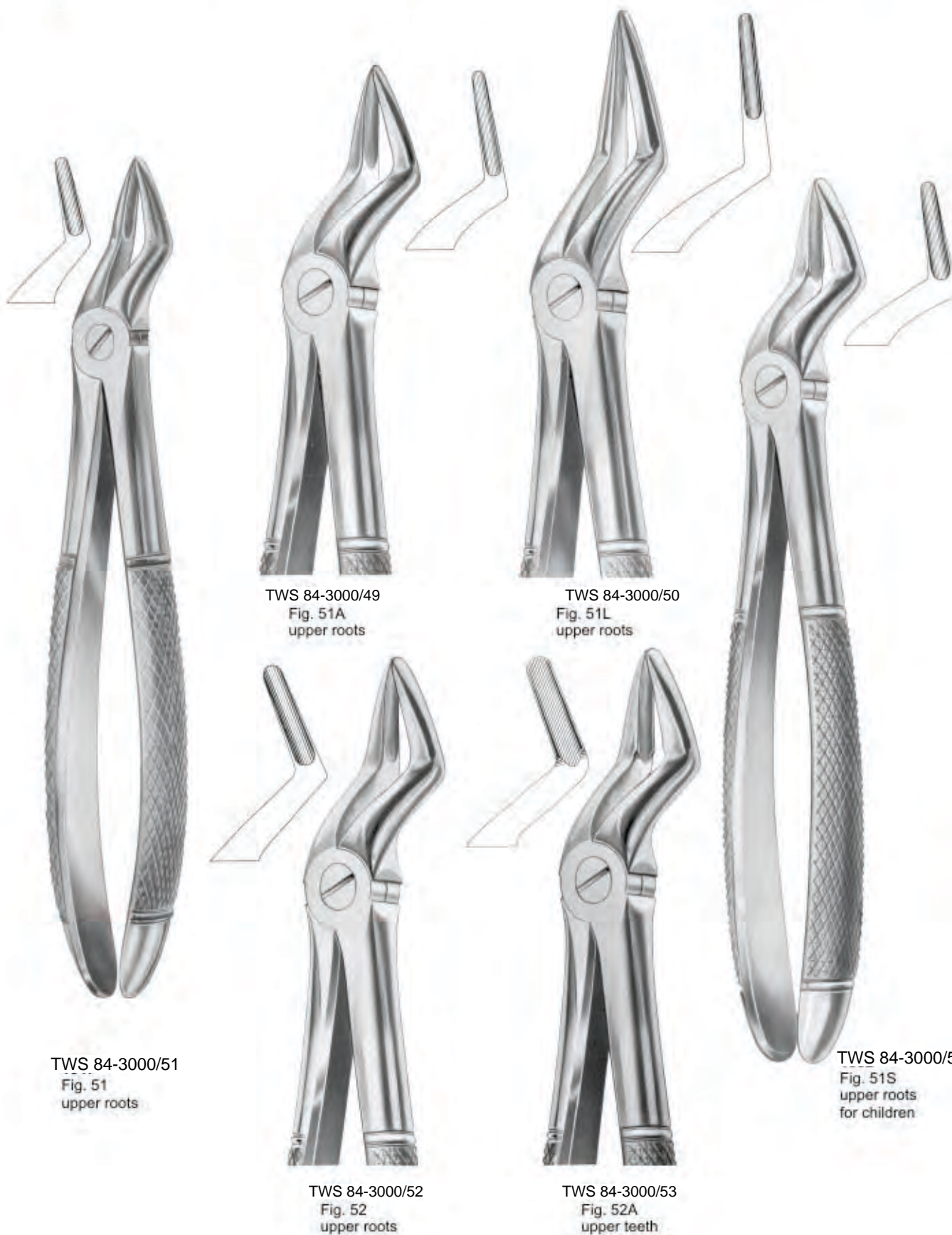

TWS 84-3000/49  
Fig. 51A  
upper roots

TWS 84-3000/50  
Fig. 51L  
upper roots

TWS 84-3000/51  
Fig. 51  
upper roots

TWS 84-3000/54  
Fig. 51S  
upper roots  
for children

TWS 84-3000/52  
Fig. 52  
upper roots

TWS 84-3000/53  
Fig. 52A  
upper teeth

Treasure Wright (U.K.) Ltd.

128-160 City Road, London, EC1V 2NX, United Kingdom  
info@twrightmedical.com



TW Surgical

## Extracting Forceps “English Pattern”



TWS 84-3000/58  
Fig. 54  
for separating  
upper molars



TWS 84-3000/55  
Fig. 55  
for separating  
upper molars



TWS 84-3000/56  
Fig. 56  
for separating  
lower molars



TWS 84-3000/57  
Fig. 65R  
upper molars  
right



TWS 84-3000/59  
Fig. 65L  
upper molars left

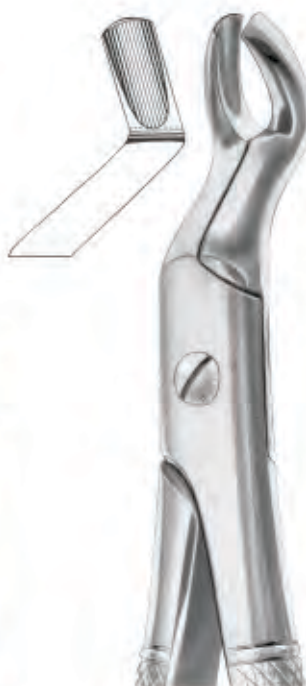

TWS 84-3000/60  
Fig. 67  
upper third molars

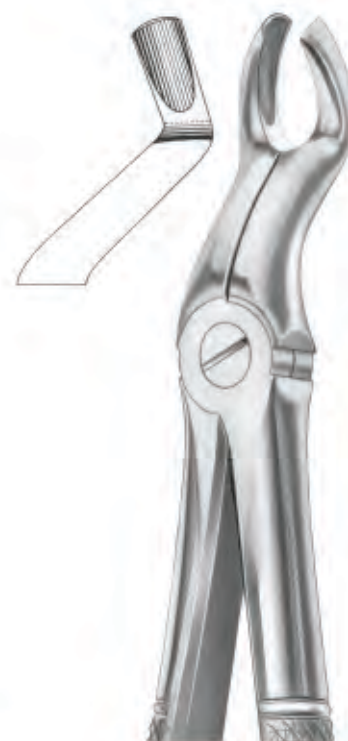

TWS 84-3000/61  
Fig. 67A  
upper third molars

Treasure Wright (U.K.) Ltd.

128-160 City Road, London, EC1V 2NX, United Kingdom  
info@twrightmedical.com



TW Surgical

## Extracting Forceps “English Pattern”



TWS 84-3000/65  
Fig. 67 1/2 R  
upper third molars  
right



TWS 84-3000/62  
Fig. 67 1/2 L  
upper third molars  
left



TWS 84-3000/63  
Fig. 68  
lower roots



TWS 84-3000/64  
Fig. 68A  
lower roots



TWS 84-3000/66  
Fig. 73  
lower molars



TWS 84-3000/67  
Fig. 73R  
lower molars right



TWS 84-3000/68  
Fig. 73L  
lower molars left

Treasure Wright (U.K.) Ltd.

128-160 City Road, London, EC1V 2NX, United Kingdom  
info@twrightmedical.com



TW Surgical

## Extracting Forceps “English Pattern”



TWS 84-3000/71  
Fig. 73A  
lower molars



TWS 84-3000/69  
Fig. 73S  
lower molars



TWS 84-3000/70  
Fig. 73B  
lower molars for children



TWS 84-3000/74  
Fig. 73K  
lower molars for children



TWS 84-3000/72  
Fig. 74  
lower roots



TWS 84-3000/73  
Fig. 74D  
lower roots

Treasure Wright (U.K.) Ltd.

128-160 City Road, London, EC1V 2NX, United Kingdom  
info@twrightmedical.com



TW Surgical

## Extracting Forceps “English Pattern”



TWS 84-3000/77  
Fig. 74M  
lower roots



TWS 84-3000/75  
Fig. 74N  
lower roots



TWS 84-3000/76  
Fig. 74XN  
lower roots and  
crowded incisors



TWS 84-3000/78  
Fig. 76N  
upper roots



TWS 84-3000/79  
Fig. 75  
lower premolars



TWS 84-3000/80  
Fig. 76  
upper roots

Treasure Wright (U.K.) Ltd.

128-160 City Road, London, EC1V 2NX, United Kingdom  
info@twrightmedical.com



TW Surgical

## Extracting Forceps “English Pattern”



TWS 84-3000/82  
Fig. 76S  
upper roots



TWS 84-3000/83  
Fig. 79  
lower third molars



TWS 84-3000/81  
Fig. 79A  
lower third molars



TWS 84-3000/84  
Fig. 81  
lower premolars  
and roots

Treasure Wright (U.K.) Ltd.

128-160 City Road, London, EC1V 2NX, United Kingdom  
info@twrightmedical.com



TW Surgical

## Extracting Forceps “English Pattern”



TWS 84-3000/88  
Fig. 86A  
lower molars



TWS 84-3000/85  
Fig. 86B  
lower molars



TWS 84-3000/86  
Fig. 86C  
lower molars



TWS 84-3000/87  
Fig. 87  
lower molars



TWS 84-3000/89  
Fig. 91  
for separating  
lower molars



TWS 84-3000/90  
Fig. 99  
lower molars

Treasure Wright (U.K.) Ltd.

128-160 City Road, London, EC1V 2NX, United Kingdom  
info@twrightmedical.com



TW Surgical

## Extracting Forceps “English Pattern”



TWS 84-3000/92  
Fig. 101  
upper premolars  
and roots

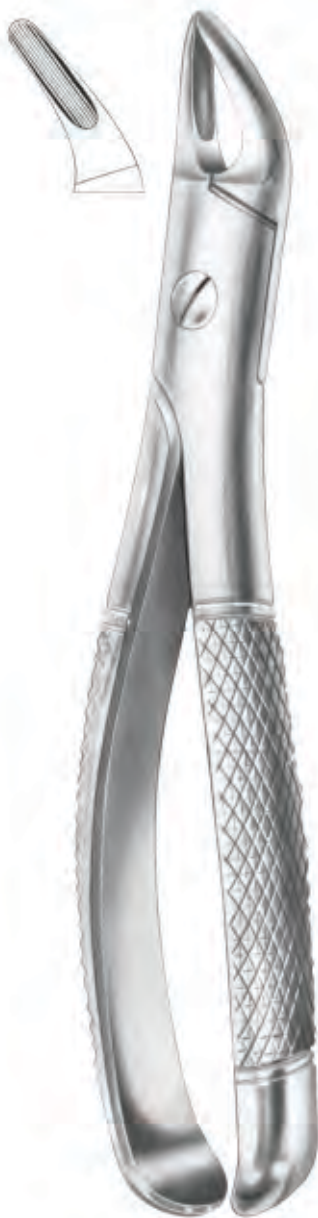

TWS 84-3000/93  
Fig. 100  
upper roots



TWS 84-3000/91  
Fig. 99 1/4  
lower molars



TWS 84-3000/94  
Fig. 99 1/2  
lower molars

Treasure Wright (U.K.) Ltd.

128-160 City Road, London, EC1V 2NX, United Kingdom  
info@twrightmedical.com



TW Surgical

## Extracting Forceps “English Pattern”



TWS 84-3000/95  
Fig. 102  
upper molars right



TWS 84-3000/96  
Fig. 103  
upper molars left



TWS 84-3000/97  
Fig. 105  
lower incisors



TWS 84-3000/98  
Fig. 106  
lower incisors



TWS 84-3000/99  
Fig. 103  
upper canines

Treasure Wright (U.K.) Ltd.

128-160 City Road, London, EC1V 2NX, United Kingdom  
info@twrightmedical.com



TW Surgical

## Extracting Forceps “English Pattern”



TWS 84-3001/02  
Fig. 112  
upper roots

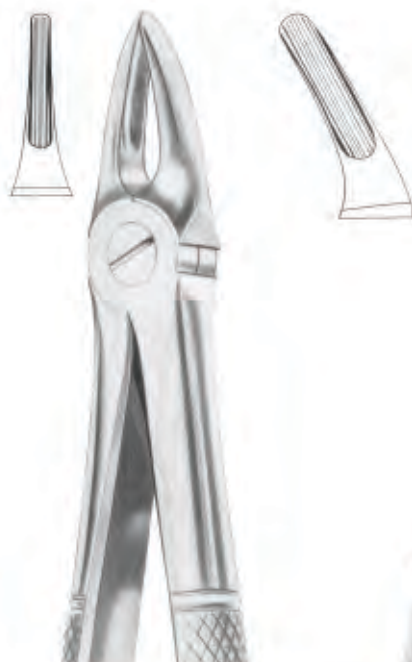

TWS 84-3001/00  
Fig. 113  
upper roots



TWS 84-3001/04  
Fig. 136  
upper premolars  
and roots



TWS 84-3001/01  
Fig. 137  
lower incisors  
and roots



TWS 84-3001/03  
Fig. 114  
upper roots



TWS 84-3001/05  
Fig. 143  
lower roots

Treasure Wright (U.K.) Ltd.

128-160 City Road, London, EC1V 2NX, United Kingdom  
info@twrightmedical.com



TW Surgical

## Extracting Forceps “English Pattern”

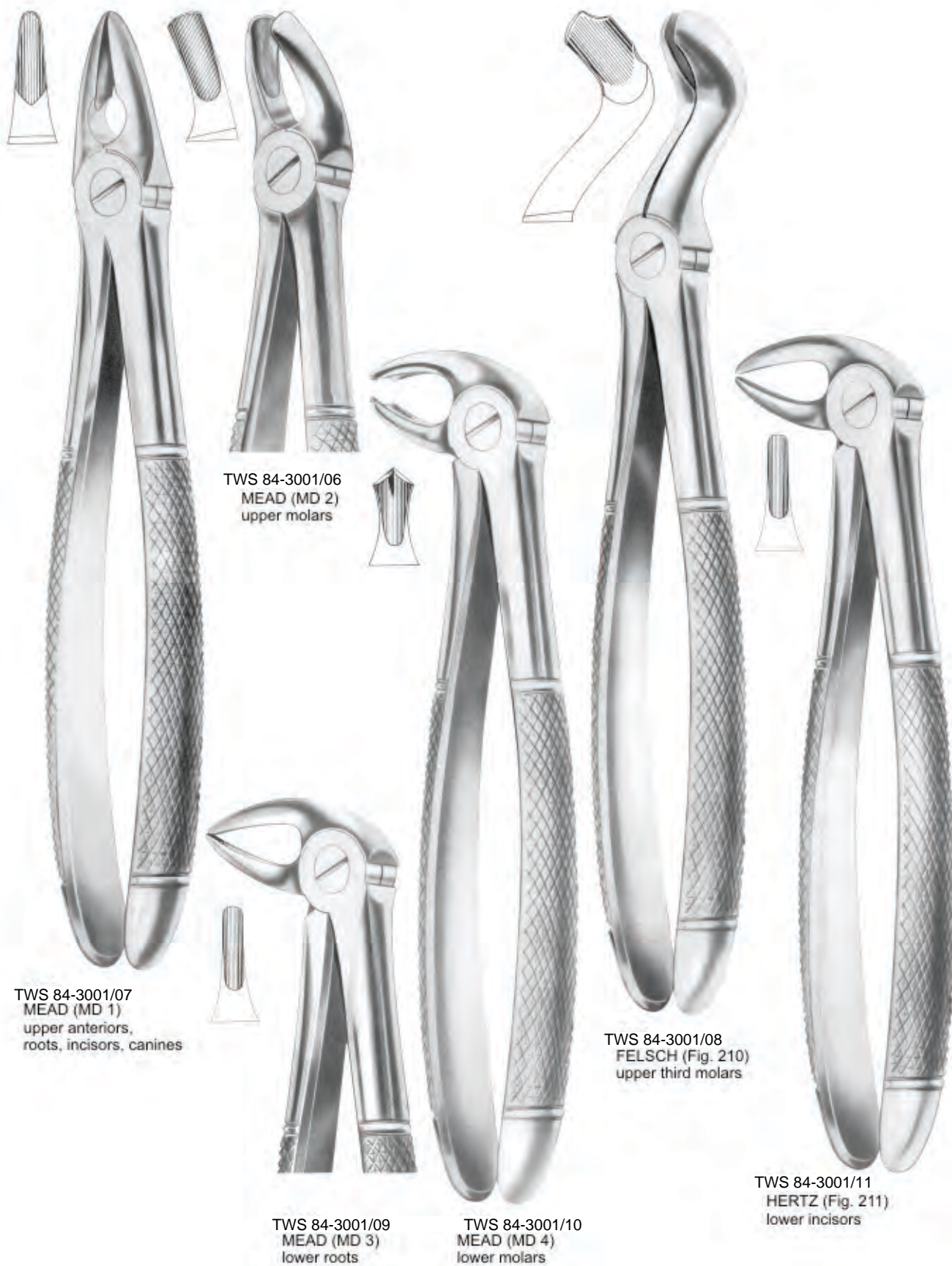

Treasure Wright (U.K.) Ltd.

128-160 City Road, London, EC1V 2NX, United Kingdom  
info@twrightmedical.com



TW Surgical

## Wisdom Extracting Forceps



TWS 84-3001/13  
ROUTURIER (Fig. 212)  
( 22 ½ L )  
lower molars  
and wisdom left



TWS 84-3001/12  
ROUTURIER (Fig. 213)  
( 22 ½ R )  
lower molars  
and wisdom right



TWS 84-3001/14  
ROUTURIER (Fig. 214)  
( 22 ½ L )  
lower molars  
and wisdom left



TWS 84-3001/15  
ROUTURIER (Fig. 215)  
( 33 ½ R )  
lower molars  
and wisdom right



TWS 84-3001/16  
RESECTION FORCEPS  
( 216/Witzel )  
upper roots

Treasure Wright (U.K.) Ltd.

128-160 City Road, London, EC1V 2NX, United Kingdom  
info@twrightmedical.com



TW Surgical

## Extracting Forceps “English Pattern”



TWS 84-3001/17  
Fig. 5



TWS 84-3001/18  
Fig. 6



TWS 84-3001/19  
Fig. 9



TWS 84-3001/20  
Fig. 10



TWS 84-3001/21  
Fig. 11



TWS 84-3001/22  
Fig. 12



TWS 84-3001/23  
Fig. 14



TWS 84-3001/24  
Fig. 15

Treasure Wright (U.K.) Ltd.

128-160 City Road, London, EC1V 2NX, United Kingdom  
info@twrightmedical.com



TW Surgical

## Extracting Forceps “English Pattern”



TWS 84-3001/25  
Fig. 25



TWS 84-3001/26  
Fig. 26

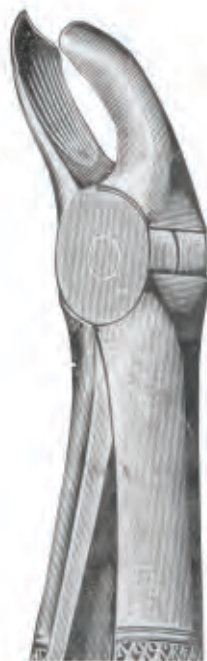

TWS 84-3001/27  
Fig. 27



TWS 84-3001/28  
Fig. 28



TWS 84-3001/29  
Fig. 34



TWS 84-3001/30  
Fig. 35



TWS 84-3001/31  
Fig. 42



TWS 84-3001/32  
Fig. 43

Treasure Wright (U.K.) Ltd.

128-160 City Road, London, EC1V 2NX, United Kingdom  
info@twrightmedical.com



TW Surgical

## Extracting Forceps “English Pattern”



TWS 84-3001/33  
Fig. 44A



TWS 84-3001/34  
Fig. 46



TWS 84-3001/35  
Fig. 47



TWS 84-3001/36  
Fig. 50A



TWS 84-3001/37  
Fig. 74R



TWS 84-3001/38  
Fig. 74L



TWS 84-3001/39  
Fig. 75R



TWS 84-3001/40  
Fig. 75L

Treasure Wright (U.K.) Ltd.

128-160 City Road, London, EC1V 2NX, United Kingdom  
info@twrightmedical.com



TW Surgical

## Extracting Forceps “English Pattern”



TWS 84-3001/41  
Fig. 94



TWS 84-3001/42  
Fig. 95



TWS 84-3001/43  
Fig. 98



TWS 84-3001/44  
Fig. 105



TWS 84-3001/45  
Fig. 106



TWS 84-3001/46  
Fig. 2002

Treasure Wright (U.K.) Ltd.

128-160 City Road, London, EC1V 2NX, United Kingdom  
info@twrightmedical.com



TW Surgical

## Extracting Forceps “With Fitting Handle”



TWS 84-3001/50  
Fig. 1  
upper laterals  
and canines



TWS 84-3001/47  
Fig. 2  
upper laterals  
and canines



TWS 84-3001/48  
Fig. 3  
upper incisors  
and canines



TWS 84-3001/49  
Fig. 4  
lower incisors  
and canines



TWS 84-3001/51  
Fig. 7  
upper premolars



TWS 84-3001/52  
Fig. 13  
lower premolars



TWS 84-3001/53  
Fig. 13S  
lower premolars  
for children

Treasure Wright (U.K.) Ltd.

128-160 City Road, London, EC1V 2NX, United Kingdom  
info@twrightmedical.com



TW Surgical

## Extracting Forceps “With Fitting Handle”



TWS 84-3001/57  
Fig. 17  
upper molars right



TWS 84-3001/54  
Fig. 18  
upper molars left



TWS 84-3001/55  
Fig. 18A  
upper molars



TWS 84-3001/56  
Fig. 18B  
upper molars



TWS 84-3001/58  
Fig. 19  
upper third molars



TWS 84-3001/59  
Fig. 22  
lower molars



TWS 84-3001/60  
Fig. 22S  
lower molars  
for children

Treasure Wright (U.K.) Ltd.

128-160 City Road, London, EC1V 2NX, United Kingdom  
info@twrightmedical.com



TW Surgical

## Extracting Forceps “With Fitting Handle”



TWS 84-3001/64  
Fig. 29  
upper roots



TWS 84-3001/61  
Fig. 29S  
upper roots  
for children



TWS 84-3001/62  
Fig. 30  
upper roots



TWS 84-3001/63  
Fig. 30S  
upper roots  
for children



TWS 84-3001/65  
Fig. 33  
lower roots



TWS 84-3001/66  
Fig. 33A  
lower roots



TWS 84-3001/67  
Fig. 33B  
lower roots

Treasure Wright (U.K.) Ltd.

128-160 City Road, London, EC1V 2NX, United Kingdom  
info@twrightmedical.com



TW Surgical

## Extracting Forceps “With Fitting Handle”



TWS 84-3001/71  
Fig. 33L  
lower roots



TWS 84-3001/68  
Fig. 33S  
lower roots  
for children



TWS 84-3001/69  
Fig. 37  
upper incisors  
for children



TWS 84-3001/70  
Fig. 39  
upper incisors  
for children



TWS 84-3001/72  
Fig. 39A  
upper molars  
for children



TWS 84-3001/73  
Fig. 39R  
upper molars right  
for children



TWS 84-3001/74  
Fig. 39L  
upper molars left  
for children

Treasure Wright (U.K.) Ltd.

128-160 City Road, London, EC1V 2NX, United Kingdom  
info@twrightmedical.com



TW Surgical

## Extracting Forceps “With Fitting Handle”



TWS 84-3001/78  
Fig. 41  
upper roots

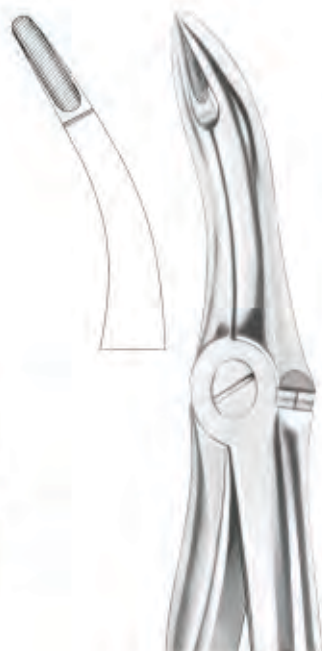

TWS 84-3001/75  
Fig. 44  
upper roots

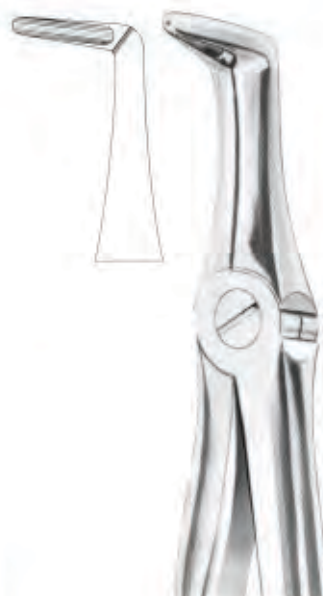

TWS 84-3001/76  
Fig. 45  
lower roots

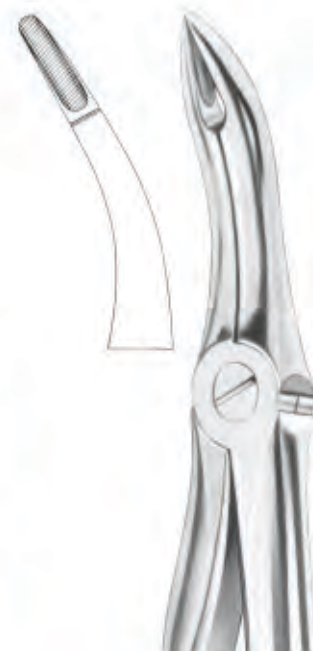

TWS 84-3001/77  
Fig. 48  
lower roots

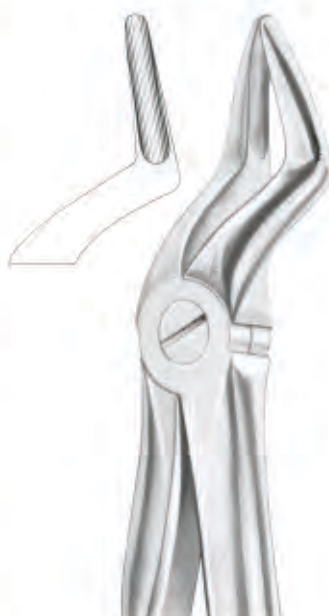

TWS 84-3001/79  
Fig. 51  
upper roots

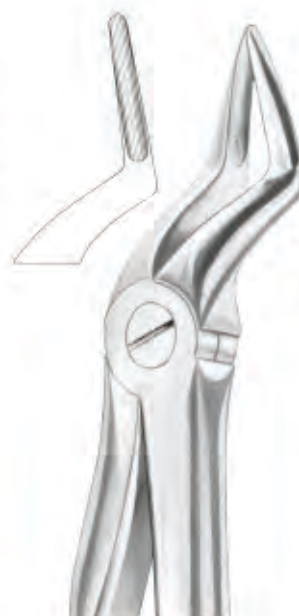

TWS 84-3001/80  
Fig. 51A  
upper roots

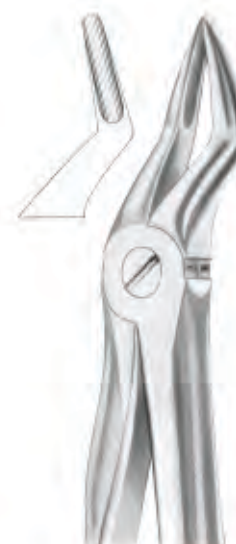

TWS 84-3001/81  
Fig. 51S  
upper roots  
for children

Treasure Wright (U.K.) Ltd.

128-160 City Road, London, EC1V 2NX, United Kingdom  
info@twrightmedical.com



TW Surgical

## Extracting Forceps “With Fitting Handle”



TWS 84-3001/85  
Fig. 51L  
upper roots



TWS 84-3001/82  
Fig. 52  
upper roots



TWS 84-3001/83  
Fig. 54  
for separating  
upper molars

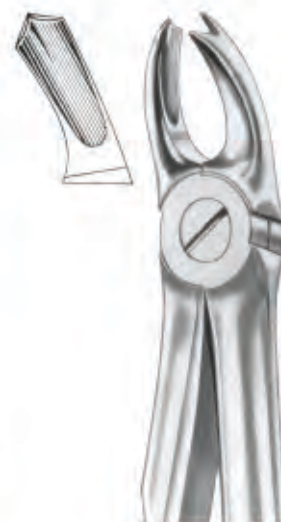

TWS 84-3001/84  
Fig. 65R  
upper molars right



TWS 84-3001/86  
Fig. 65L  
upper molars left

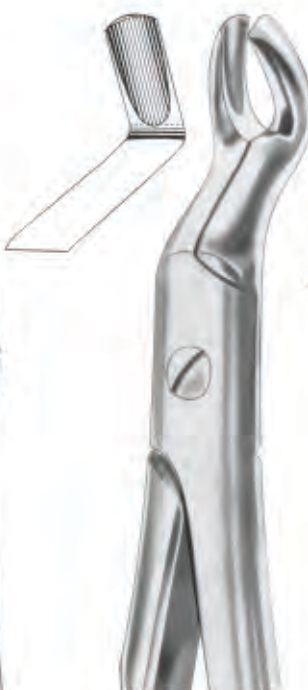

TWS 84-3001/87  
Fig. 67  
upper third molars

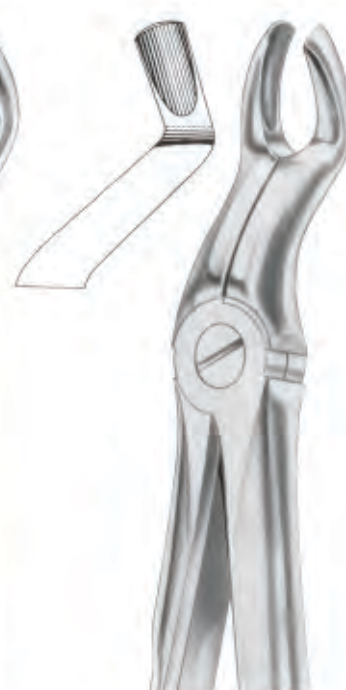

TWS 84-3001/88  
Fig. 67A  
upper third molars

Treasure Wright (U.K.) Ltd.

128-160 City Road, London, EC1V 2NX, United Kingdom  
info@twrightmedical.com



TW Surgical

## Extracting Forceps “With Fitting Handle”



TWS 84-3001/92  
Fig. 67 ½ R  
upper third molars  
right

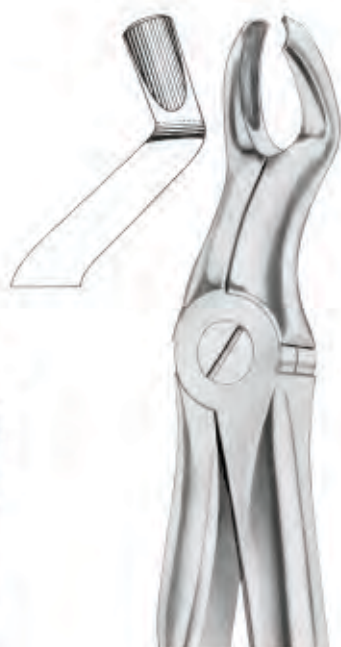

TWS 84-3001/89  
Fig. 67 ½ L  
upper third molars  
left



TWS 84-3001/90  
Fig. 73  
lower molars



TWS 84-3001/91  
Fig. 74  
lower roots



TWS 84-3001/93  
Fig. 74M  
lower roots



TWS 84-3001/94  
Fig. 74N  
lower roots



TWS 84-3001/95  
Fig. 74XN  
lower roots and  
crowded incisors

Treasure Wright (U.K.) Ltd.

128-160 City Road, London, EC1V 2NX, United Kingdom  
info@twrightmedical.com



TW Surgical

## Extracting Forceps “With Fitting Handle”



TWS 84-3001/98  
Fig. 75  
lower premolars



TWS 84-3001/96  
Fig. 76  
upper roots



TWS 84-3001/97  
Fig. 76N  
upper roots



TWS 84-3002/01  
Fig. 79  
lower third molars



TWS 84-3001/99  
Fig. 81  
lower premolars  
and roots



TWS 84-3002/00  
Fig. 76A  
lower third molars

Treasure Wright (U.K.) Ltd.

128-160 City Road, London, EC1V 2NX, United Kingdom  
info@twrightmedical.com



TW Surgical

## Extracting Forceps “With Fitting Handle”



TWS 84-3002/05  
Fig. 86A  
lower molars



TWS 84-3002/02  
Fig. 86B  
lower molars



TWS 84-3002/03  
Fig. 86C  
lower molars



TWS 84-3002/04  
Fig. 99  
lower molars



TWS 84-3002/06  
Fig. 99 1/4  
lower molars



TWS 84-3002/07  
Fig. 136  
upper premolars  
and roots



TWS 84-3002/08  
Fig. 143  
lower roots

Treasure Wright (U.K.) Ltd.

128-160 City Road, London, EC1V 2NX, United Kingdom  
info@twrightmedical.com



TW Surgical

# Extracting Forceps "For Children"



TWS 84-3002/10  
KLEIN (Fig. 217)  
upper incisors



TWS 84-3002/11  
KLEIN (Fig. 218)  
upper premolars



TWS 84-3002/12  
KLEIN (Fig. 219)  
upper roots

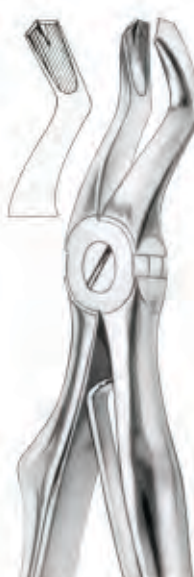

TWS 84-3002/09  
KLEIN (Fig. 220)  
upper molars



TWS 84-3002/13  
ALBRECHT  
Fig. 224  
Deciduous



TWS 84-3002/14  
ALBRECHT  
Fig. 225  
Deciduous



TWS 84-3002/15  
KLEIN (Fig. 221)  
lower incisors



TWS 84-3002/16  
KLEIN (Fig. 222)  
lower molars



TWS 84-3002/17  
KLEIN (Fig. 223)  
lower roots

Treasure Wright (U.K.) Ltd.

128-160 City Road, London, EC1V 2NX, United Kingdom  
info@twrightmedical.com



TW Surgical

# Root Splinter Forceps

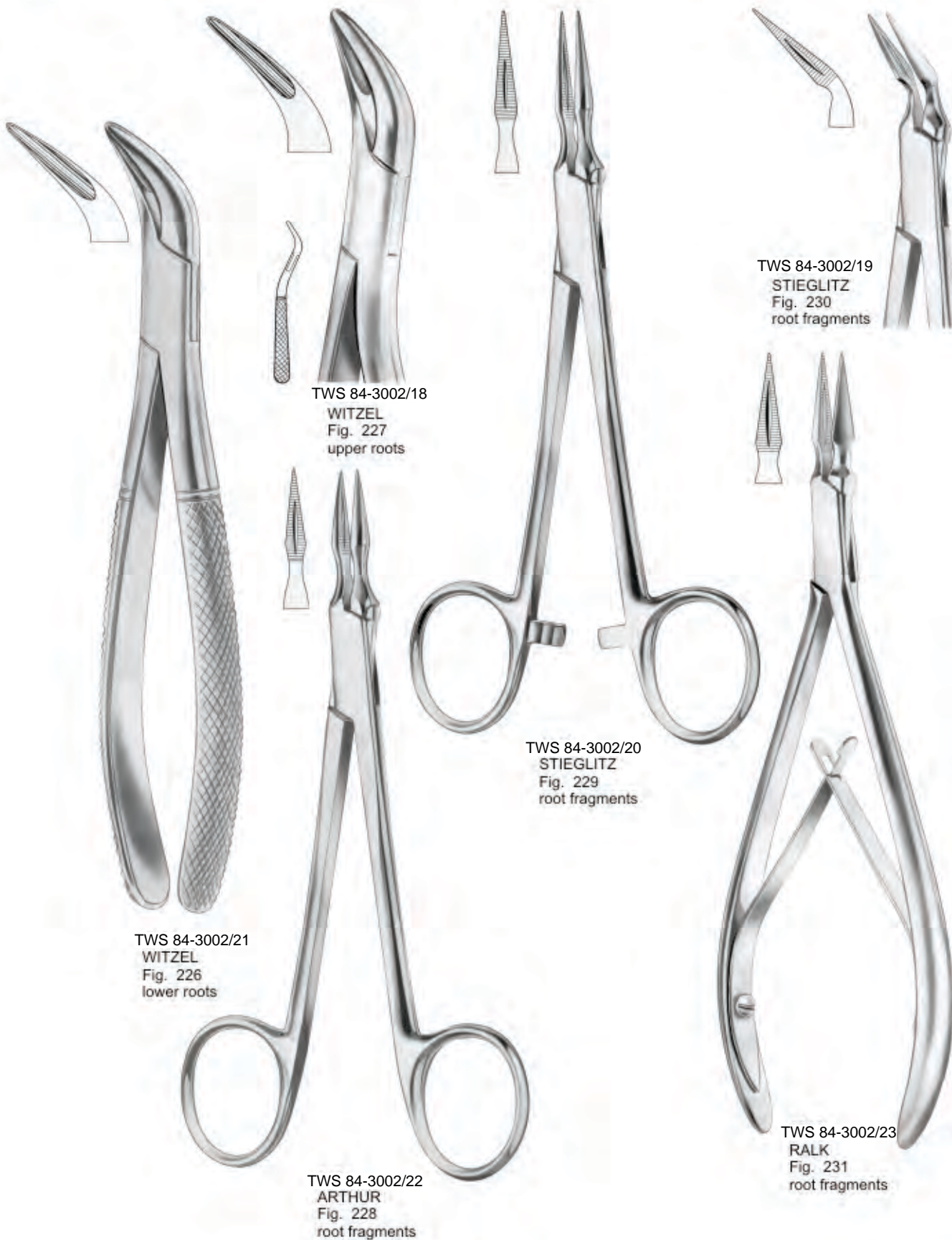

TWS 84-3002/18  
WITZEL  
Fig. 227  
upper roots

TWS 84-3002/19  
STIEGLITZ  
Fig. 230  
root fragments

TWS 84-3002/21  
WITZEL  
Fig. 226  
lower roots

TWS 84-3002/20  
STIEGLITZ  
Fig. 229  
root fragments

TWS 84-3002/22  
ARTHUR  
Fig. 228  
root fragments

TWS 84-3002/23  
RALK  
Fig. 231  
root fragments

Treasure Wright (U.K.) Ltd.

128-160 City Road, London, EC1V 2NX, United Kingdom  
info@twrightmedical.com



TW Surgical

## Extracting Forceps "American Pattern"



TWS 84-3002/26  
W1-WINTER  
upper centrals  
and canines



TWS 84-3002/24  
Fig. 1  
upper incisors and roots



TWS 84-3002/25  
Fig. 2  
upper and lower roots



TWS 84-3002/27  
Fig. 4  
upper and lower premolars



TWS 84-3002/28  
PHYSICK  
Fig. 5  
lower third molars



TWS 84-3002/29  
Fig. 6  
separating  
forceps

Treasure Wright (U.K.) Ltd.

128-160 City Road, London, EC1V 2NX, United Kingdom  
info@twrightmedical.com



TW Surgical

## Extracting Forceps “American Pattern”



TWS 84-3002/32  
Fig. 7  
upper roots

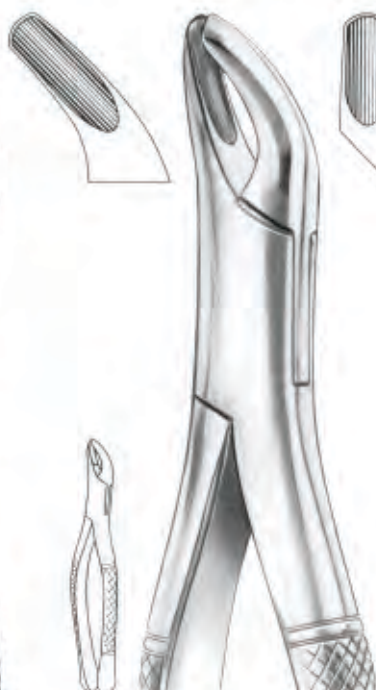

TWS 84-3002/30  
Fig. 8  
upper and lower  
third molars



TWS 84-3002/33  
Fig. 10H  
upper molars



TWS 84-3002/31  
Fig. 13  
upper incisors

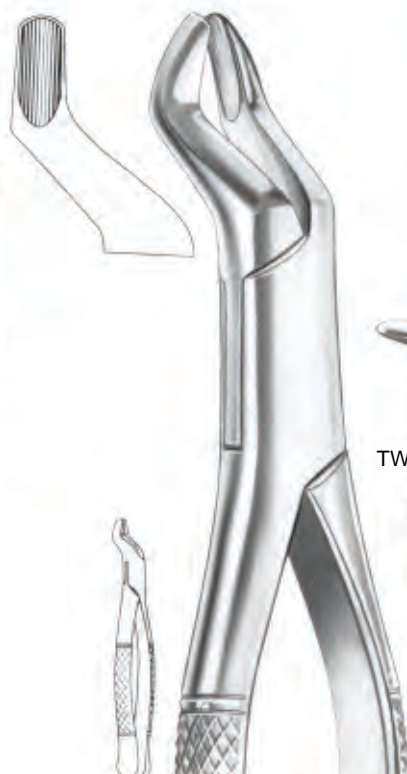

TWS 84-3002/35  
Fig. 10S  
upper molars



TWS 84-3002/34  
Fig. 14  
lower incisors

Treasure Wright (U.K.) Ltd.

128-160 City Road, London, EC1V 2NX, United Kingdom  
info@twrightmedical.com



TW Surgical

## Extracting Forceps “American Pattern”

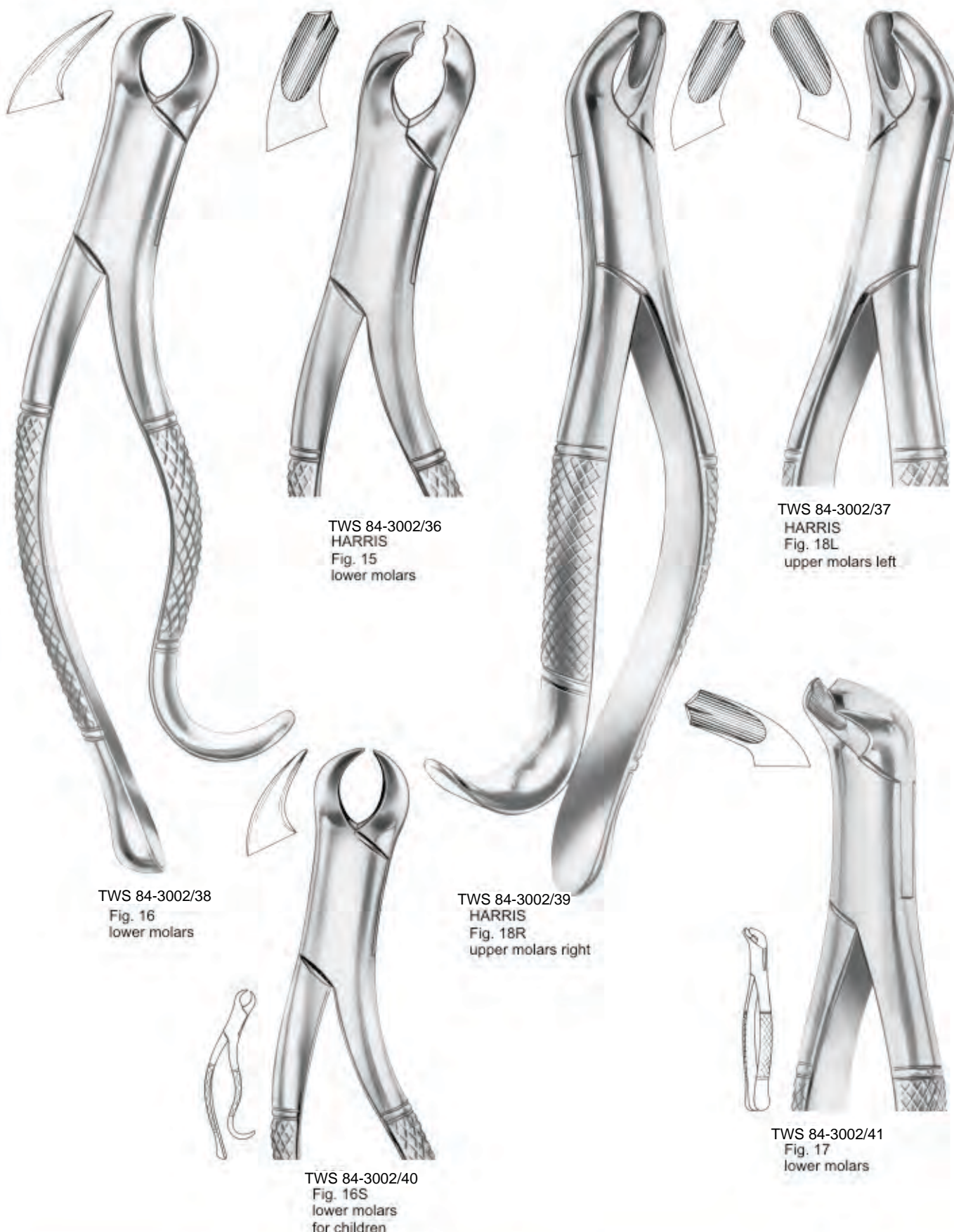

Treasure Wright (U.K.) Ltd.

128-160 City Road, London, EC1V 2NX, United Kingdom  
info@twrightmedical.com



TW Surgical

## Extracting Forceps “American Pattern”

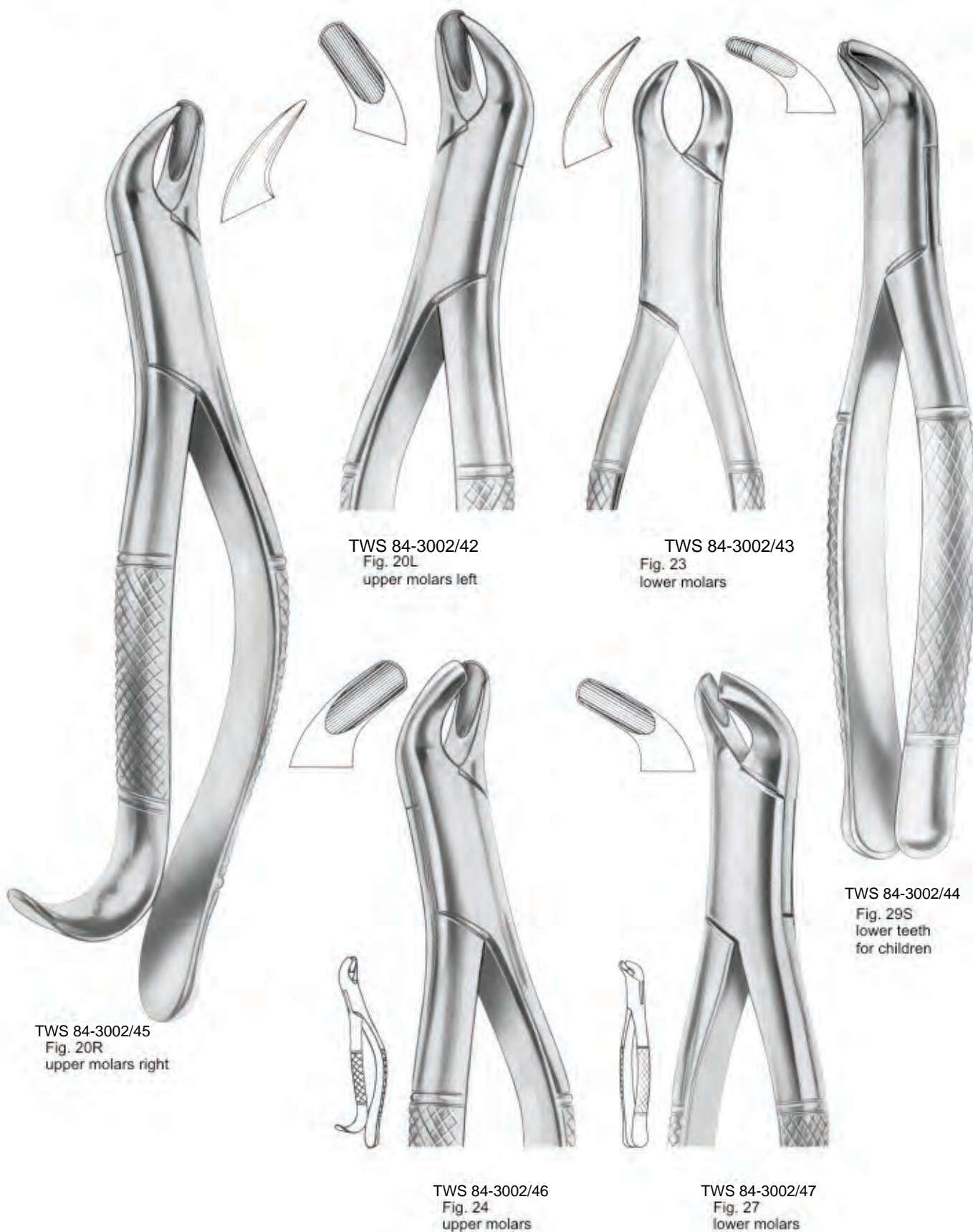

Treasure Wright (U.K.) Ltd.

128-160 City Road, London, EC1V 2NX, United Kingdom  
info@twrightmedical.com



TW Surgical

## Extracting Forceps “American Pattern”

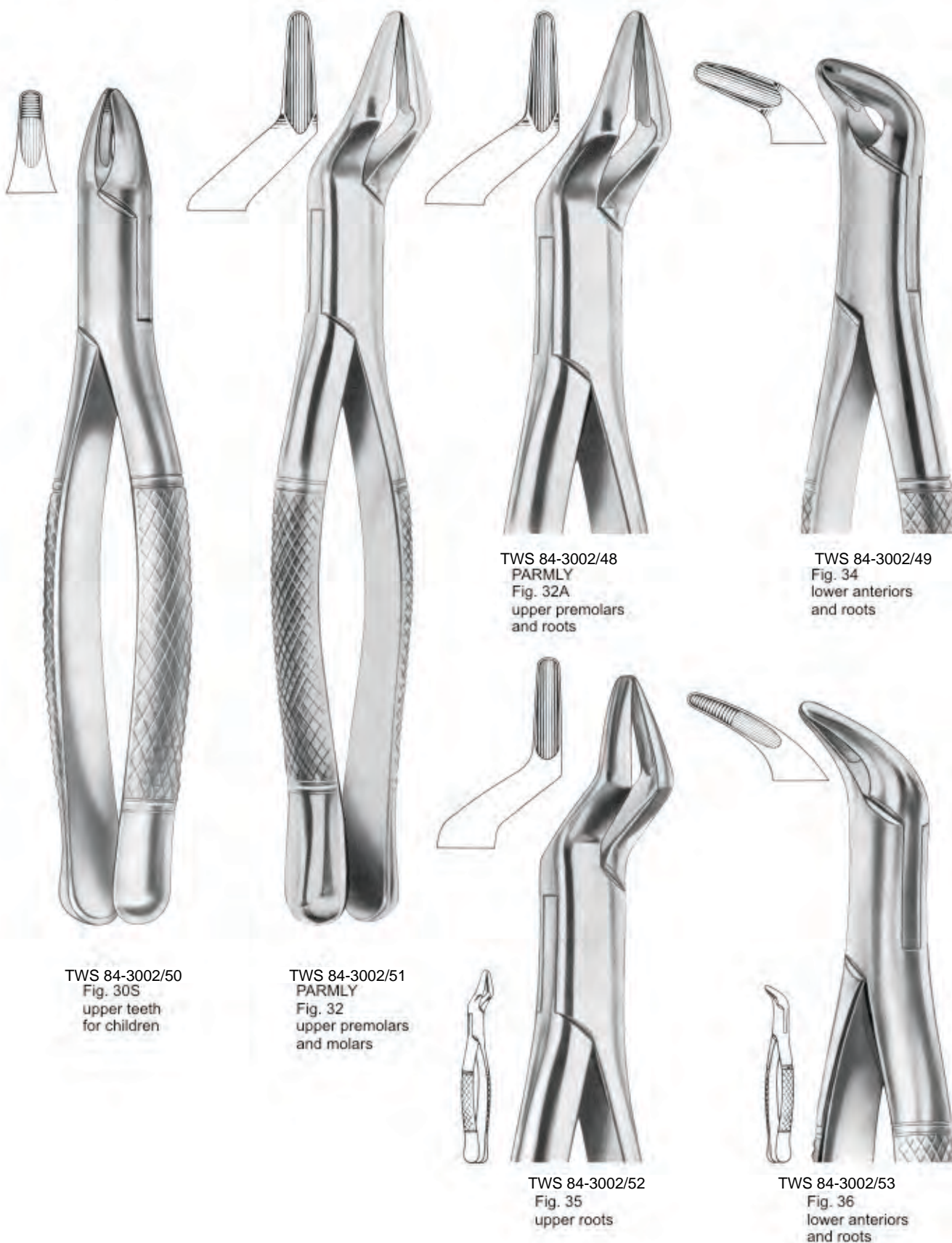

TWS 84-3002/50  
Fig. 30S  
upper teeth  
for children

TWS 84-3002/51  
PARMLY  
Fig. 32  
upper premolars  
and molars

TWS 84-3002/48  
PARMLY  
Fig. 32A  
upper premolars  
and roots

TWS 84-3002/49  
Fig. 34  
lower anteriors  
and roots

TWS 84-3002/52  
Fig. 35  
upper roots

TWS 84-3002/53  
Fig. 36  
lower anteriors  
and roots

Treasure Wright (U.K.) Ltd.

128-160 City Road, London, EC1V 2NX, United Kingdom  
info@twrightmedical.com



TW Surgical

## Extracting Forceps “American Pattern”



TWS 84-3002/54  
Fig. 37  
lower anteriors  
and roots



TWS 84-3002/55  
Fig. 53L  
upper molars left



TWS 84-3002/58  
Fig. 38  
upper anteriors



TWS 84-3002/56  
Fig. 53R  
upper molars right



TWS 84-3002/59  
Fig. 62  
incisors, premolars.



TWS 84-3002/57  
Fig. 65  
upper incisors  
and roots

Treasure Wright (U.K.) Ltd.

128-160 City Road, London, EC1V 2NX, United Kingdom  
info@twrightmedical.com



TW Surgical

## Extracting Forceps “American Pattern”



TWS 84-3002/62  
TOMES  
Fig. 69  
upper and lower roots



TWS 84-3002/61  
TOMES  
Fig. 85  
lower canines,  
premolars and molars



TWS 84-3002/60  
NEVIUS  
Fig. 88R  
upper molars right



TWS 84-3002/63  
THOMAS  
Fig. 85A  
lower canines,  
premolars and molars



TWS 84-3002/64  
NEVIUS  
Fig. 88L  
upper molars left

Treasure Wright (U.K.) Ltd.

128-160 City Road, London, EC1V 2NX, United Kingdom  
info@twrightmedical.com



TW Surgical

## Extracting Forceps “American Pattern”

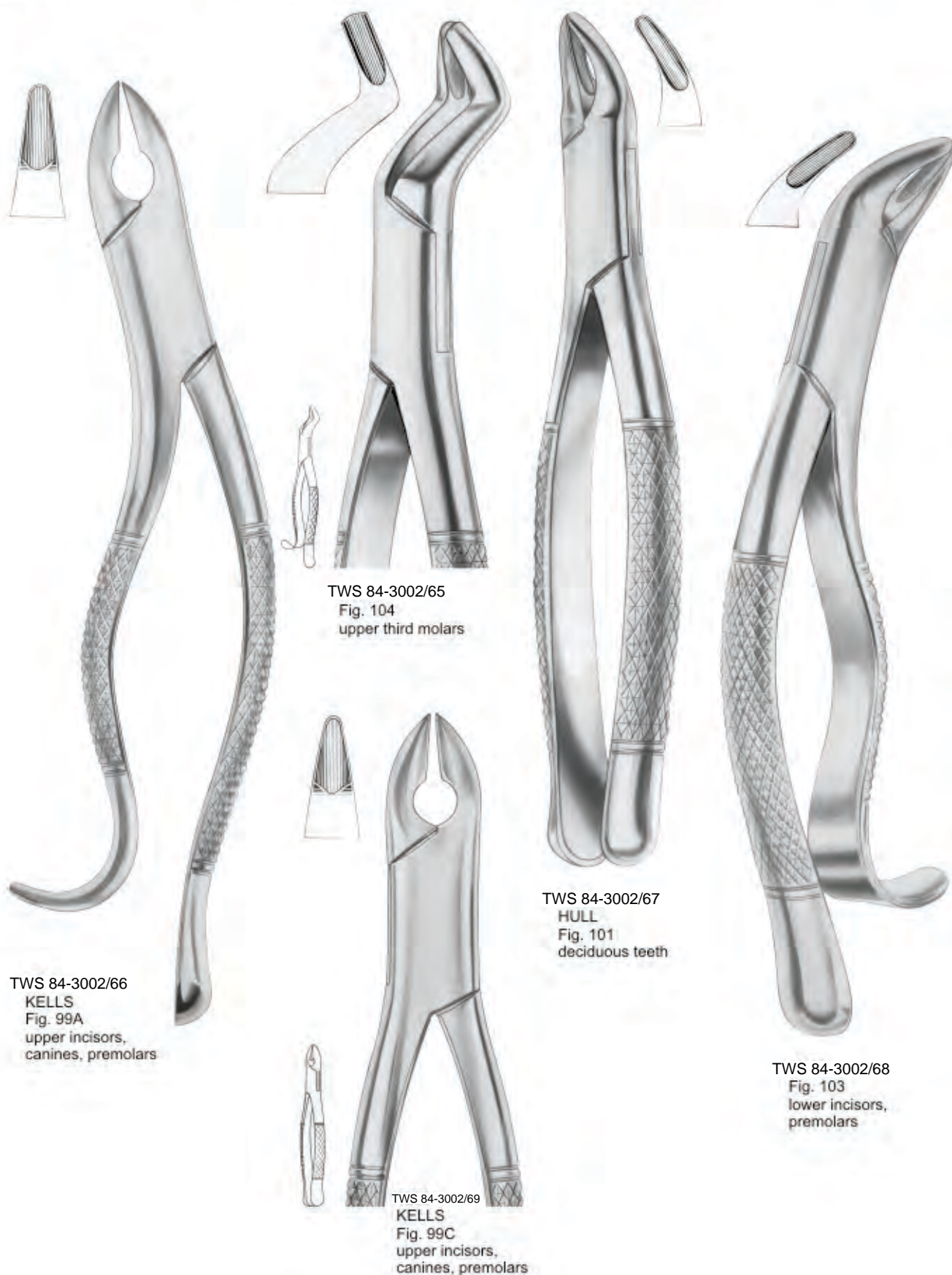

Treasure Wright (U.K.) Ltd.

128-160 City Road, London, EC1V 2NX, United Kingdom  
info@twrightmedical.com



TW Surgical

# Extracting Forceps “American Pattern”



TWS 84-3002/72  
CRYER  
Fig. 150  
lower incisors,  
premolars, roots



TWS 84-3002/70  
CRYER  
Fig. 150A  
upper incisors,  
premolars, roots



TWS 84-3002/73  
CRYER  
Fig. 151  
lower incisors,  
premolars, roots



TWS 84-3002/71  
CRYER  
Fig. 151A  
lower incisors,  
premolars, roots

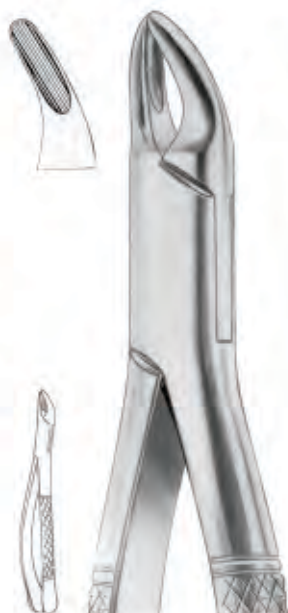

TWS 84-3002/74  
CRYER  
Fig. 150S  
upper teeth for children

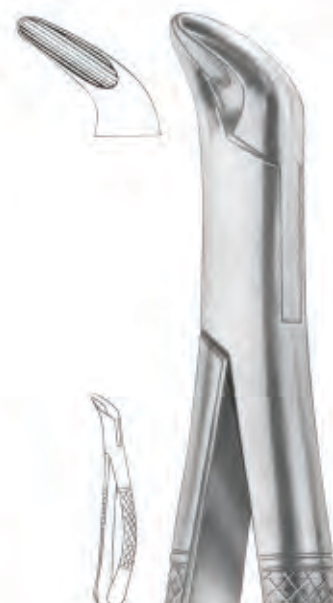

TWS 84-3002/75  
CRYER  
Fig. 151S  
lower teeth  
for children

Treasure Wright (U.K.) Ltd.

128-160 City Road, London, EC1V 2NX, United Kingdom  
info@twrightmedical.com



TW Surgical

## Extracting Forceps “American Pattern”



TWS 84-3002/78  
Fig. 203  
lower incisors  
and roots



TWS 84-3002/76  
Fig. 210S  
upper third molars



TWS 84-3002/80  
Fig. 210H  
upper third molars



TWS 84-3002/77  
Fig. 213  
upper centrals and canines



TWS 84-3002/79  
Fig. 201  
upper incisors,  
canines, premolars



TWS 84-3002/81  
Fig. 217  
lower molars

Treasure Wright (U.K.) Ltd.

128-160 City Road, London, EC1V 2NX, United Kingdom  
info@twrightmedical.com



TW Surgical

## Extracting Forceps “American Pattern”

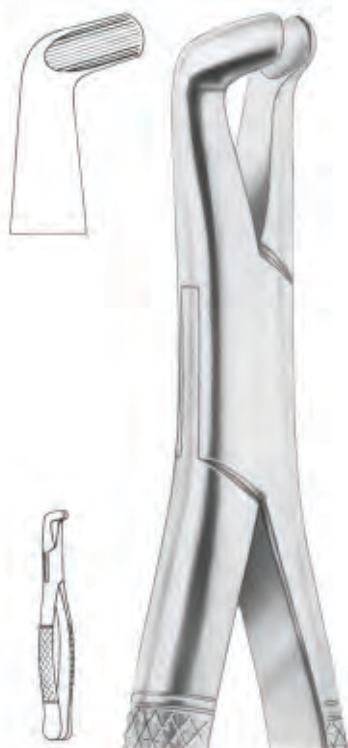

TWS 84-3002/82  
Fig. 222  
lower third molars.



TWS 84-3002/83  
Fig. 286  
Swing lower molars



TWS 84-3002/85  
Fig. 288  
lower canines  
and premolars

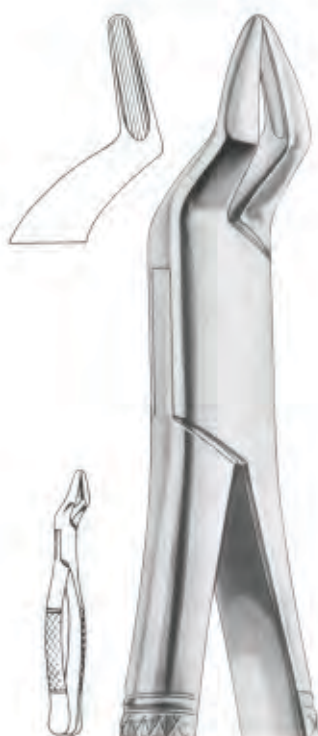

TWS 84-3002/84  
Fig. 286  
upper incisors and roots

Treasure Wright (U.K.) Ltd.

128-160 City Road, London, EC1V 2NX, United Kingdom  
info@twrightmedical.com



TW Surgical

## Extracting Forceps “American Pattern”

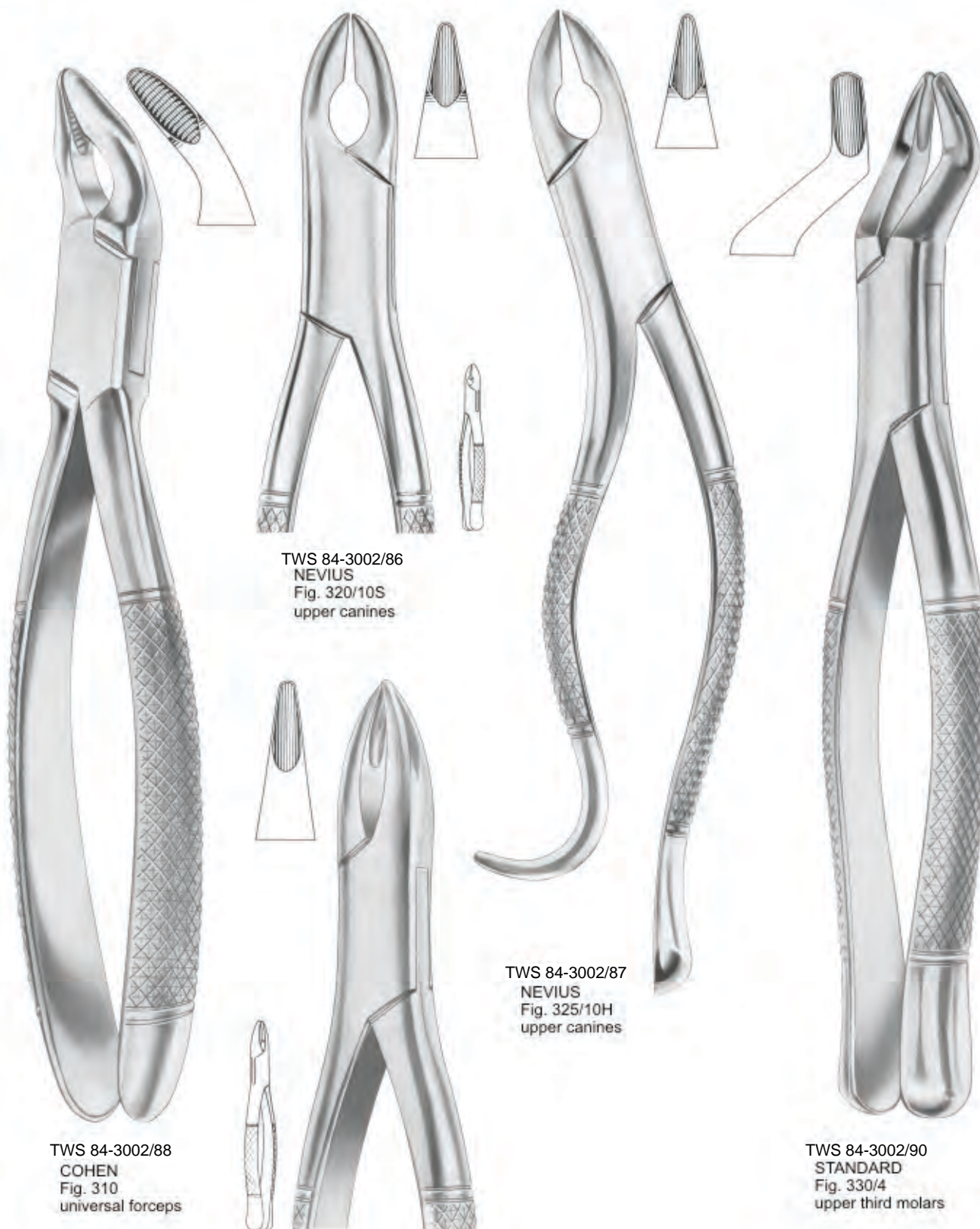

TWS 84-3002/86  
NEVIUS  
Fig. 320/10S  
upper canines

TWS 84-3002/87  
NEVIUS  
Fig. 325/10H  
upper canines

TWS 84-3002/88  
COHEN  
Fig. 310  
universal forceps

TWS 84-3002/89  
HENAHAN  
Fig. 315/1A upper incisors

TWS 84-3002/90  
STANDARD  
Fig. 330/4  
upper third molars

Treasure Wright (U.K.) Ltd.

128-160 City Road, London, EC1V 2NX, United Kingdom  
info@twrightmedical.com



TW Surgical

## Extracting Forceps “American Pattern”



TWS 84-3002/92  
WOODWARD  
Fig. 335/FH  
lower molars

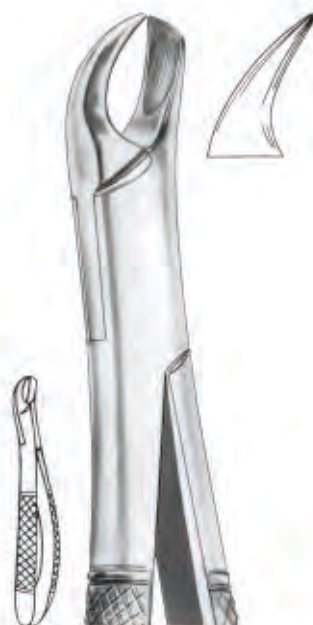

TWS 84-3002/91  
Fig. 340/89  
upper molars right



TWS 84-3002/94  
Fig. 345/90  
upper molars left

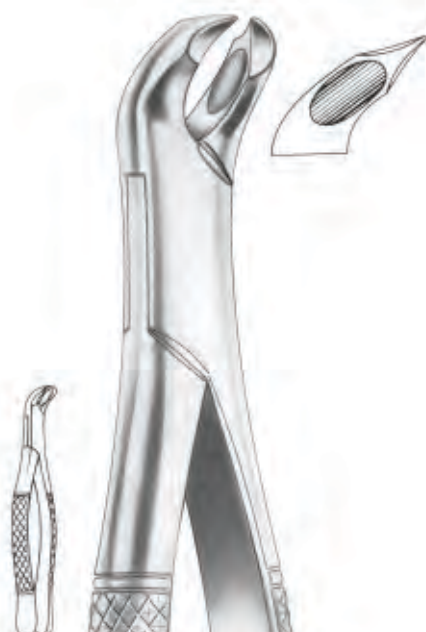

TWS 84-3002/93  
WOODWARD  
Fig. 335/FS  
lower molars

Treasure Wright (U.K.) Ltd.

128-160 City Road, London, EC1V 2NX, United Kingdom  
info@twrightmedical.com



TW Surgical

## Forceps For Children "American Pattern"

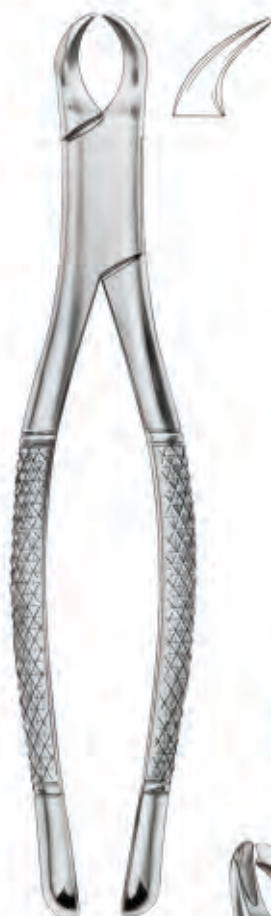

TWS 84-3002/95  
Fig. 350/23S  
lower molars



TWS 84-3002/96  
Fig. 355/23SK  
lower molars



TWS 84-3002/97  
Forcep Fig. 301



TWS 84-3002/98  
Forcep Fig. 300



TWS 84-3002/99  
Fig. 360/17SK  
lower molars



TWS 84-3003/00  
Fig. 365/150SK  
upper anteriors  
and roots



TWS 84-3003/01  
Fig. 370/151SK  
lower anteriors  
and roots

Treasure Wright (U.K.) Ltd.

128-160 City Road, London, EC1V 2NX, United Kingdom  
info@twrightmedical.com



TW Surgical

## Peristeel Elevators



TWS 84-3003/02  
Molt 9



TWS 84-3003/03  
Allen 9A



TWS 84-3003/04  
Prichard



TWS 84-3003/05  
Seldin



TWS 84-3003/06  
Goldman- Fox 14



TWS 84-3003/07  
West  
Dell W2

**Treasure Wright (U.K.) Ltd.**

128-160 City Road, London, EC1V 2NX, United Kingdom  
info@twrightmedical.com



TW Surgical

# Elevators

## Root Tip



TWS 84-3003/10  
DEL 78



TWS 84-3003/08  
DEL 79



TWS 84-3003/11  
DEL 80

## Heidbrink Root - Tip Picks



TWS 84-3003/13  
DEL H1



TWS 84-3003/09  
DEL H2



TWS 84-3003/12  
DEL H3



TWS 84-3003/15  
DEL H2-3



TWS 84-3003/14  
POTT  
6X



TWS 84-3003/16  
POTT  
7X



TW Surgical

## Periosteal Elevators



TWS 84-3003/17  
BUSER



TWS 84-3003/18  
OHI 10



TWS 84-3003/19  
HOWARD 9H



TWS 84-3003/20  
FREER



TWS 84-3003/21  
FREER 15



TWS 84-3003/22  
FREER 16

Treasure Wright (U.K.) Ltd.

128-160 City Road, London, EC1V 2NX, United Kingdom  
info@twrightmedical.com



TW Surgical

# Root Elevators

lower jaw, left side

lower jaw, right side



TWS 84-3003/23  
BEIN  
Fig. 4



TWS 84-3003/24



TWS 84-3003/25

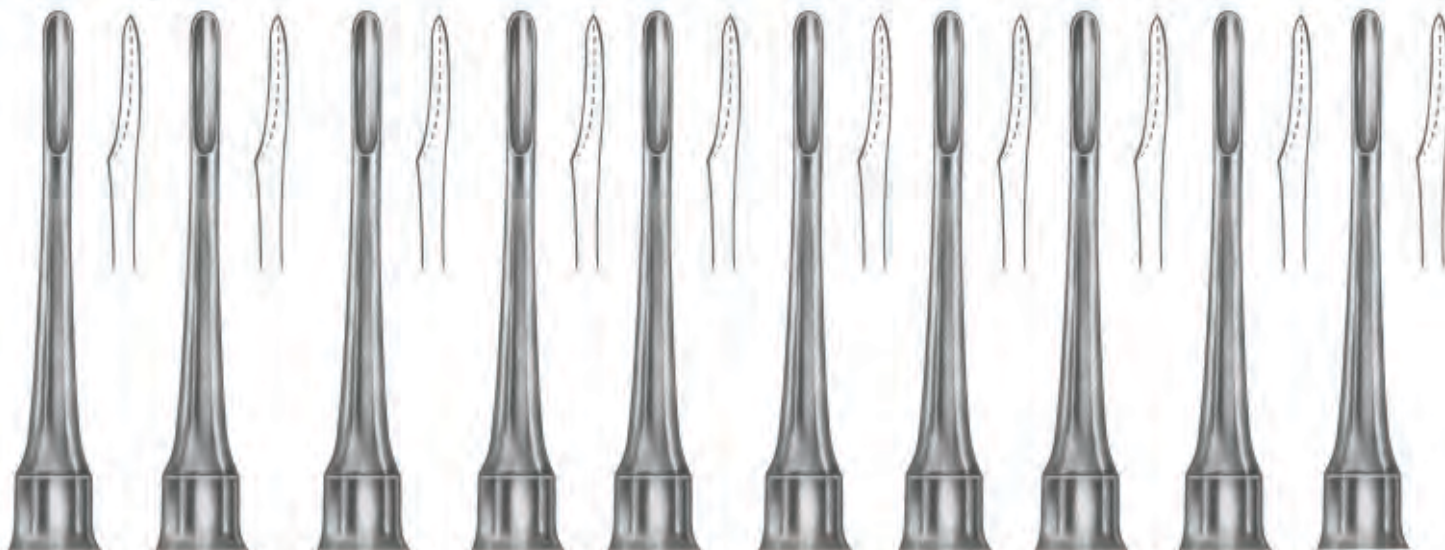

TWS 84-3003/26	TWS 84-3003/27	TWS 84-3003/28	TWS 84-3003/29	TWS 84-3003/29 <sup>1</sup>	TWS 84-3003/30	TWS 84-3003/31	TWS 84-3003/32	TWS 84-3003/33	TWS 84-3003/33 <sup>1</sup>
BEIN 1.0 mm	BEIN 1.5 mm	BEIN 2.0 mm	BEIN 2.5 mm	BEIN 3.0 mm	BEIN 3.5 mm	BEIN 4.0 mm	BEIN 4.5 mm	BEIN 5.0 mm	BEIN 5.5 mm

Treasure Wright (U.K.) Ltd.

128-160 City Road, London, EC1V 2NX, United Kingdom  
info@twrightmedical.com



TW Surgical

# Root Elevators



TWS 84-3003/38  
BEIN



TWS 84-3003/34  
BEIN  
Fig. 1



TWS 84-3003/35  
BEIN  
Fig. 2



TWS 84-3003/36  
BEIN  
Fig. 0



TWS 84-3003/37  
BEIN  
Fig. 3



TWS 84-3003/39  
BEIN  
Fig. 4



TWS 84-3003/40  
BEIN  
Fig. 5



TWS 84-3003/41  
BEIN  
Fig. 6

Treasure Wright (U.K.) Ltd.

128-160 City Road, London, EC1V 2NX, United Kingdom  
info@twrightmedical.com



TW Surgical

# Root Elevators



TWS 84-3003/42  
CRYER  
Fig. 4

TWS 84-3003/43  
CRYER  
Fig. 12

TWS 84-3003/44  
CRYER  
Fig. 27

TWS 84-3003/45  
CRYER  
Fig. 28

TWS 84-3003/46  
CRYER  
Fig. 27S

TWS 84-3003/47  
CRYER  
Fig. 28S



TWS 84-3003/48  
CRYER  
Fig. 3

TWS 84-3003/49  
SELDIN  
Fig. 2

TWS 84-3003/50  
SELDIN  
Fig. 3

TWS 84-3003/51  
SELDIN  
Fig. 4L

TWS 84-3003/52  
SELDIN  
Fig. 4R

TWS 84-3003/53  
SELDIN  
Fig. 1L

TWS 84-3003/54  
SELDIN  
Fig. 1R

Treasure Wright (U.K.) Ltd.

128-160 City Road, London, EC1V 2NX, United Kingdom  
info@twrightmedical.com



TW Surgical

## Swa Elevators & Root Screws



TWS 84-3003/58



TWS 84-3003/55



TWS 84-3003/56



TWS 84-3003/57



TWS 84-3003/59



TWS 84-3003/60



TWS 84-3003/61

## Root Screws



TWS 84-3003/62  
Morrison  
2.0 mm



TWS 84-3003/63  
Morrison  
2.5 mm



TWS 84-3003/64  
Morrison  
3.0 mm



TWS 84-3003/65  
Morrison  
3.5 mm

Treasure Wright (U.K.) Ltd.

128-160 City Road, London, EC1V 2NX, United Kingdom  
info@twrightmedical.com



TW Surgical

# Root Elevators



TWS 84-3003/75  
IS-APICAL



TWS 84-3003/66  
APICAL  
2 mm  
Fig. 1



TWS 84-3003/67  
APICAL  
3 mm  
Fig. 2



TWS 84-3003/68  
APICAL  
4 mm  
Fig. 3



TWS 84-3003/69  
APICAL  
4.5 mm  
Fig. 4



TWS 84-3003/70  
APICAL  
2 mm  
Fig. 5



TWS 84-3003/71  
APICAL  
3 mm  
Fig. 6



TWS 84-3003/72  
APICAL  
4 mm  
Fig. 7



TWS 84-3003/73  
APICAL  
4.5 mm  
Fig. 8



TWS 84-3003/74  
APICAL  
Fig. 9



TWS 84-3003/76  
WINTER  
Fig. 14 L



TWS 84-3003/77  
WINTER  
Fig. 14 R



TWS 84-3003/78  
HEIDBRINK  
Fig. 1



TWS 84-3003/79  
HEIDBRINK  
Fig. 2



TWS 84-3003/80  
FLOHR  
Fig. 1



TWS 84-3003/81  
FLOHR  
Fig. 2



TWS 84-3003/82  
APICAL  
Fig. 1



TWS 84-3003/83  
APICAL  
Fig. 2

Treasure Wright (U.K.) Ltd.

128-160 City Road, London, EC1V 2NX, United Kingdom  
info@twrightmedical.com



TW Surgical

## Root Elevators



TWS 84-3003/89  
IS-CRYER



TWS 84-3003/84  
CRYER  
Fig. 1



TWS 84-3003/85  
CRYER  
Fig. 2



TWS 84-3003/90  
IS-COUPLAND



TWS 84-3003/86  
COUPLAND  
Fig. 1



TWS 84-3003/87  
COUPLAND  
Fig. 2



TWS 84-3003/88  
COUPLAND  
Fig. 3



TW Surgical

# Root Elevators



TWS 84-3003/95  
Fig. 1



TWS 84-3003/91  
Fig. 2



TWS 84-3003/92  
Fig. 3



TWS 84-3003/96  
FLOHR  
Fig. 1

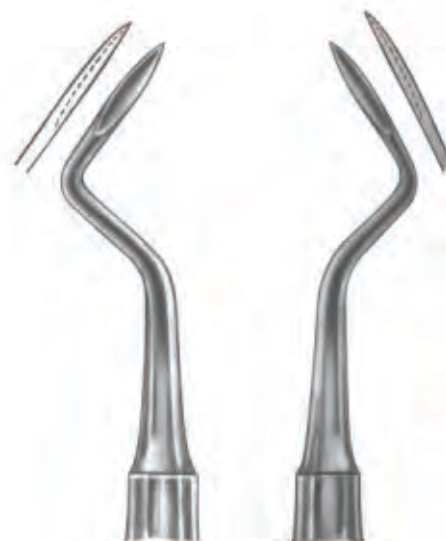

TWS 84-3003/93  
FLOHR  
Fig. 2

TWS 84-3003/94  
FLOHR  
Fig. 3



TW Surgical

# Root Elevators



TWS 84-3003/97 KOPP Fig. 1  
TWS 84-3003/98 KOPP Fig. 2



TWS 84-3003/99 KOPP Fig. 1  
TWS 84-3004/00 KOPP Fig. 2



TWS 84-3004/05 KOPP



TWS 84-3004/01 KOPP Fig. 3  
TWS 84-3004/02 KOPP Fig. 4



TWS 84-3004/08 KOPP



TWS 84-3004/03 KOPP Fig. 3  
TWS 84-3004/04 KOPP Fig. 4



TWS 84-3004/06 KOPP Fig. 5  
TWS 84-3004/07 KOPP Fig. 6

Treasure Wright (U.K.) Ltd.

128-160 City Road, London, EC1V 2NX, United Kingdom  
info@twrightmedical.com



TW Surgical

# Root Elevators



TWS 84-3004/09  
HYLIN  
Fig. 1

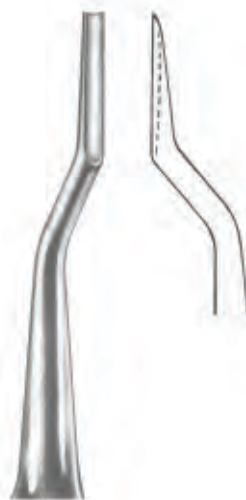

TWS 84-3004/10  
BEIN  
Fig. 1



TWS 84-3004/11  
BEIN  
Fig. 2



TWS 84-3004/12  
HYLIN



TWS 84-3004/13  
HYLIN  
Fig. 2



TWS 84-3004/14  
BEIN



TWS 84-3004/15  
BEIN  
Fig. 3



TWS 84-3004/16  
BEIN  
Fig. 4

Treasure Wright (U.K.) Ltd.

128-160 City Road, London, EC1V 2NX, United Kingdom  
info@twrightmedical.com



TW Surgical

## Root Elevators



TWS 84-3004/21  
WARWICK-JAMES  
Fig. 1



TWS 84-3004/17  
Warwick-James  
Fig. 2



TWS 84-3004/18  
Warwick-James  
Fig. 3



TWS 84-3004/22  
London-Hospital  
Fig. 1



TWS 84-3004/19  
London-Hospital  
Fig. 2



TWS 84-3004/20  
London-Hospital  
Fig. 3



TWS 84-3004/23  
OTT

Treasure Wright (U.K.) Ltd.

128-160 City Road, London, EC1V 2NX, United Kingdom  
info@twrightmedical.com



TW Surgical

# Root Elevators



TWS 84-3004/28  
CHOMPRET  
Fig. 1



TWS 84-3004/24  
CHOMPRET  
Fig. 2



TWS 84-3004/25  
CHOMPRET  
Fig. 3



TWS 84-3004/26  
CHOMPRET  
Fig. 4



TWS 84-3004/27  
Fig. 1



TWS 84-3004/31  
Fig. 2

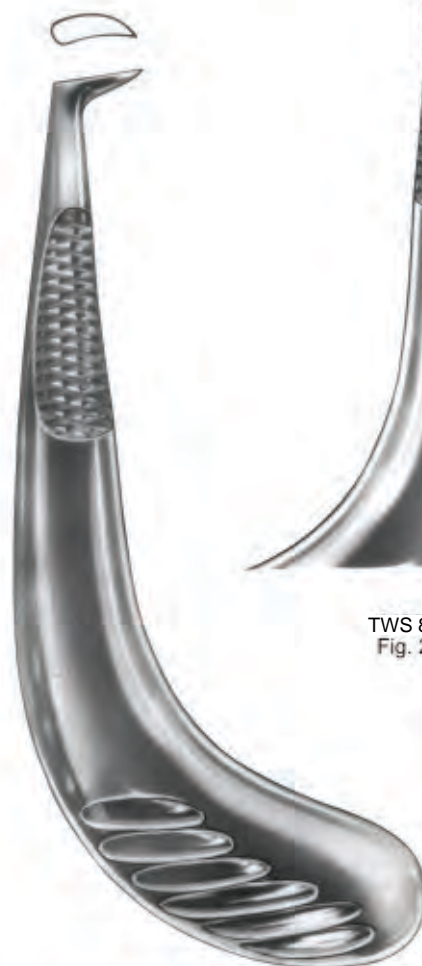

TWS 84-3004/32  
Fig. 1



TWS 84-3004/29  
Fig. 2



TWS 84-3004/30  
APICAL

Treasure Wright (U.K.) Ltd.

128-160 City Road, London, EC1V 2NX, United Kingdom  
info@twrightmedical.com



TW Surgical

# Root Tip Elevators



TWS 84-3004/33 Fig. 2  
TWS 84-3004/34 Fig. 3



TWS 84-3004/35 HEIDBRINK Fig. 2  
TWS 84-3004/36 HEIDBRINK Fig. 3



TWS 84-3004/37 IS-Fig. 1



TWS 84-3004/38 HEIDBRINK Fig. 1



TWS 84-3004/39 MEAD MD1



TWS 84-3004/40 LECLUSE



TWS 84-3004/41 MEAD MD-5 A



TWS 84-3004/42 MEAD MD-6 A



TWS 84-3004/43 MEAD MD-7 A



TWS 84-3004/44 MEAD MD-8

Treasure Wright (U.K.) Ltd.

128-160 City Road, London, EC1V 2NX, United Kingdom  
info@twrightmedical.com



TW Surgical

# Root Elevators



TWS 84-3004/45  
WINTER  
Fig. 1L



TWS 84-3004/46  
WINTER  
Fig. 1R



TWS 84-3004/47  
WINTER  
Fig. 2L



TWS 84-3004/48  
WINTER  
Fig. 2R



TWS 84-3004/53  
WINTER



TWS 84-3004/49  
WINTER  
Fig. 11L



TWS 84-3004/50  
WINTER  
Fig. 11R



TWS 84-3004/51  
WINTER  
Fig. 12L



TWS 84-3004/52  
WINTER  
Fig. 12R



TWS 84-3004/54  
WINTER  
Fig. 14L



TWS 84-3004/55  
WINTER  
Fig. 14R

Treasure Wright (U.K.) Ltd.

128-160 City Road, London, EC1V 2NX, United Kingdom  
info@twrightmedical.com



TW Surgical

# Root Elevators



TWS 84-3004/56  
BARRY  
Fig. 1



TWS 84-3004/57  
BARRY  
Fig. 2



TWS 84-3004/58  
BARRY  
Fig. 3



TWS 84-3004/59  
BARRY  
Fig. 4



TWS 84-3004/64  
BARRY



TWS 84-3004/60  
BARRY  
Fig. 11



TWS 84-3004/61  
BARRY  
Fig. 12



TWS 84-3004/62  
BARRY  
Fig. 17



TWS 84-3004/63  
BARRY  
Fig. 18

Treasure Wright (U.K.) Ltd.

128-160 City Road, London, EC1V 2NX, United Kingdom  
info@twrightmedical.com



TW Surgical

## Root Elevators



TWS 84-3004/65  
CRYER  
Fig. 26



TWS 84-3004/66  
SELDIN  
Fig. 27



TWS 84-3004/67  
CRYER  
Fig. 28



TWS 84-3004/68  
CRYER  
Fig. 29



TWS 84-3004/69  
HEIDBRINK  
Fig. 22



TWS 84-3004/70  
HEIDBRINK  
Fig. 23



TWS 84-3004/71

Treasure Wright (U.K.) Ltd.

128-160 City Road, London, EC1V 2NX, United Kingdom  
info@twrightmedical.com



TW Surgical

## Root Elevators



TWS 84-3004/72  
KOPP  
Fig. 31



TWS 84-3004/73  
KOPP  
Fig. 32



TWS 84-3004/74  
KOPP  
Fig. 33



TWS 84-3004/75  
KOPP  
Fig. 34



TWS 84-3004/76  
KOPP  
Fig. 35



TWS 84-3004/77  
KOPP  
Fig. 44

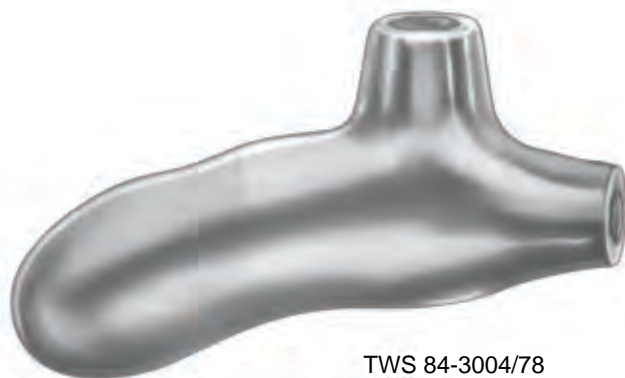

TWS 84-3004/78



TW Surgical

# Root Elevators



TWS 84-3004/79  
HEIDBRINK  
Fig. 10



TWS 84-3004/80  
WINTER  
Fig. 11



TWS 84-3004/81  
WINTER  
Fig. 12



TWS 84-3004/82  
BARRY  
Fig. 17



TWS 84-3004/83  
BARRY  
Fig. 18



TWS 84-3004/84  
BARRY  
Fig. 20

## Root Elevators according to Dr. Sader, with interchangeable working tips



TWS 84-3004/85



TWS 84-3004/88



TWS 84-3004/86



TWS 84-3004/87

Treasure Wright (U.K.) Ltd.

128-160 City Road, London, EC1V 2NX, United Kingdom  
info@twrightmedical.com

## Elevators Plastic Handle

1481

Root Elevator, Plastic Handle, Set of 10 Pcs

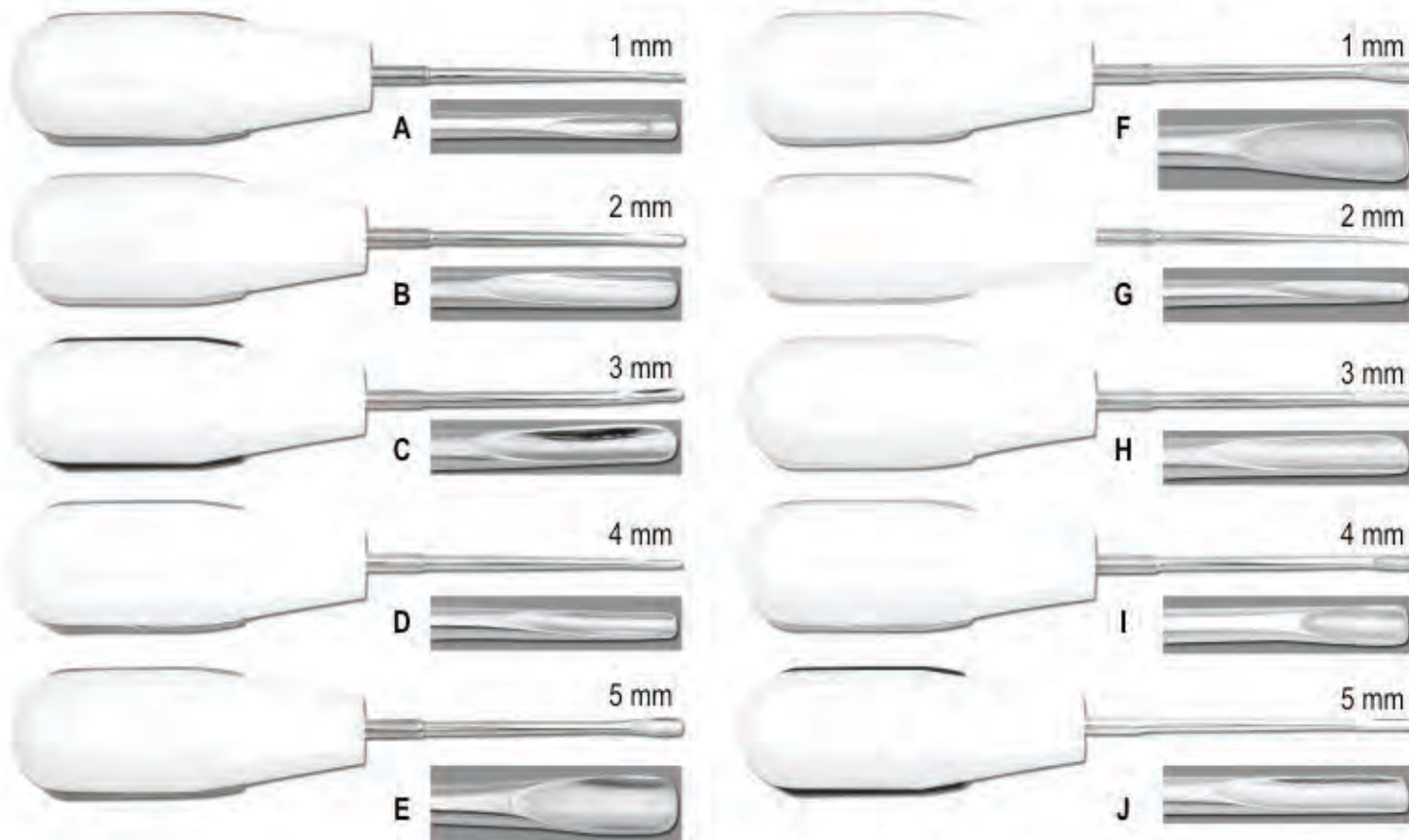

TWS 84-3004/89

Root Elevator, Plastic Handle, Set of 5 Pcs

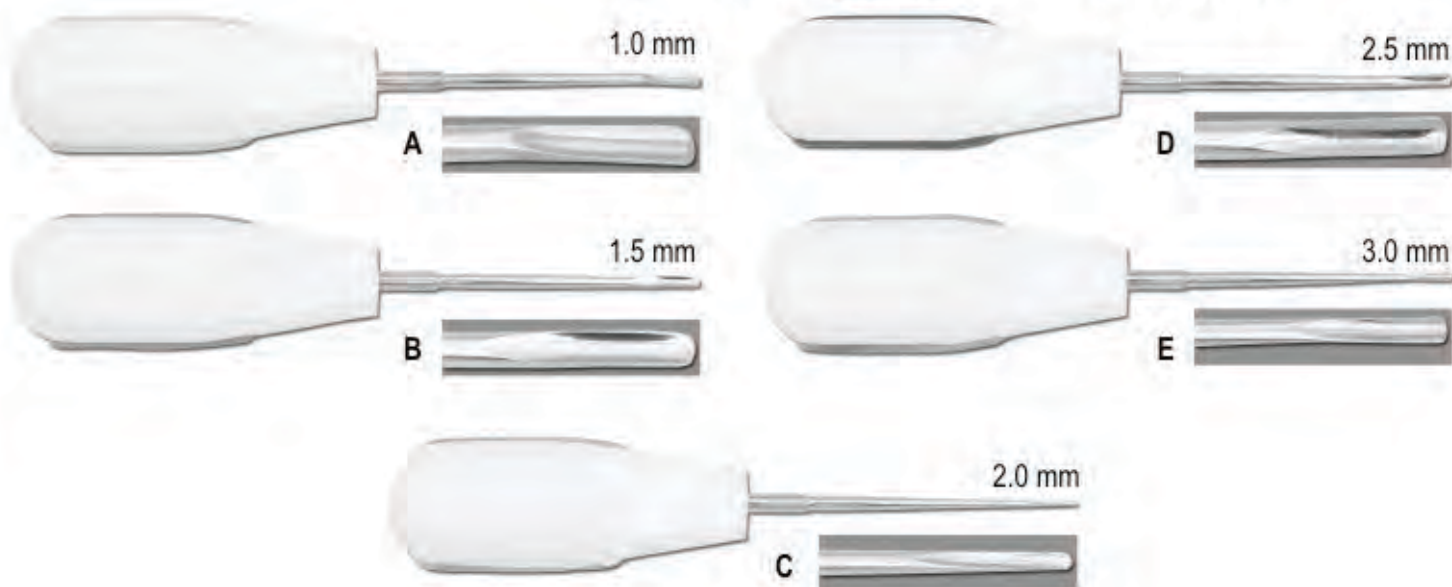



TW Surgical

# Scalpel Handles



TWS 84-3004/90

Scalpel Handle Angle Of Blade Adjusts To Easily Get Around Corners  
Adjustment Sets Blade From Straight To Back Angled  
Locks In At 90°, 60°, 30°, Straight, -30°, -60° Angles



TWS 84-3004/91  
Scalpel Handle  
Fig. 5



TWS 84-3004/92  
Scalpel Handle  
Curved



TWS 84-3004/93  
Fig. 3L



TWS 84-3004/94  
Fig. 7



Scalpel Handle  
Fig. 4L, Curved  
20 cm



TWS 84-3004/95  
Fig. 3



TWS 84-3004/96  
Fig. 3G



TWS 84-3004/97  
Fig. 4



TWS 84-3004/98



Scalpel Handle  
4 D 14.0 cm



Mess Holders



Gouge  
Blade Handle  
Fig. 2 / 11.5 cm

Treasure Wright (U.K.) Ltd.

128-160 City Road, London, EC1V 2NX, United Kingdom  
info@twrightmedical.com



TW Surgical

## Handles

Handle For Mouth Mirrors, Probes, Explorers, Excavators, Carvers, Curettes & Scalers



TWS 84-3005/02

Handle No. 2 Standard Single Ended

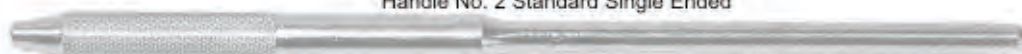

TWS 84-3005/03

Handle Single Ended



TWS 84-3005/04

Handle Single Ended



TWS 84-3005/05

Handle Single Ended

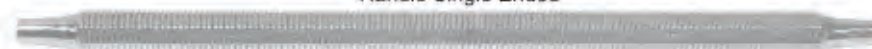

TWS 84-3005/06

Octagonal Double Ended



TWS 84-3005/07

Octagonal Double Ended



TWS 84-3005/08

Octagonal Double Ended



TWS 84-3005/09

Handle No. 2 (Standard Double Ended)



TWS 84-3005/10

Octagonal Double Ended

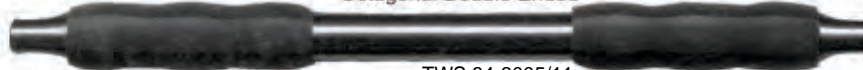

TWS 84-3005/11

Tactile Tone Double Ended

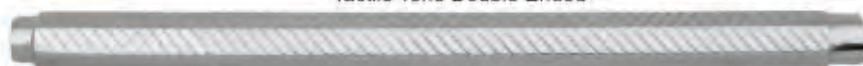

TWS 84-3005/12

Tactile Tone Double Ended

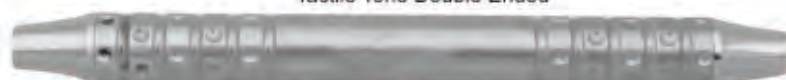

TWS 84-3005/13

Tactile Tone Double Ended

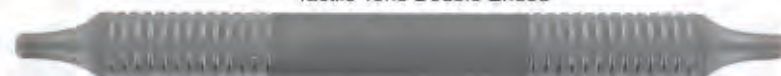

TWS 84-3005/14

Handle, Double Ended



TWS 84-3005/15

Double Ended

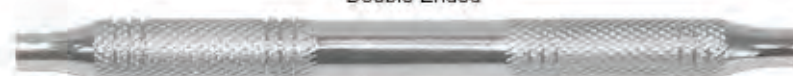

TWS 84-3005/16

Tactile Tone Double Ended



TWS 84-3005/17

Tactile Tone Double Ended

Treasure Wright (U.K.) Ltd.

128-160 City Road, London, EC1V 2NX, United Kingdom  
info@twrightmedical.com

# Handles & Mouth Mirrors



TWS 84-3005/27 Hollow Handle Fig.1  
TWS 84-3005/28 Hollow Handle Fig.2



1513-A

## Mouth Mirrors, Magnifying 1513-A Plain 1512-B

Fig. 00	Ø 8 mm
Fig. 0	Ø 10 mm
Fig. 1	Ø 14 mm
Fig. 2	Ø 16 mm
Fig. 3	Ø 18 mm
Fig. 4	Ø 20 mm
Fig. 5	Ø 22 mm
Fig. 6	Ø 24 mm
Fig. 7	Ø 26 mm
Fig. 8	Ø 28 mm
Fig. 9	Ø 30 mm
Fig. 10	Ø 32 mm

## Mouth Mirrors

### Plane



TWS 84-3005/18 Fig.6  
Ø 26 mm

TWS 84-3005/19 Fig.5  
Ø 24 mm

TWS 84-3005/20 Fig.4  
Ø 22 mm

### Magnifying



TWS 84-3005/21 Fig.6  
Ø 26 mm

TWS 84-3005/22 Fig.5  
Ø 24 mm

TWS 84-3005/23 Fig.4  
Ø 22 mm

### Front surface



TWS 84-3005/24 Fig.6  
Rhodium  
Ø 26 mm  
Front surface

TWS 84-3005/25 Fig.5  
Rhodium  
Ø 24 mm  
Front surface

TWS 84-3005/26 Fig.4  
Rhodium  
Ø 22 mm  
Front surface

### Plane



TWS 84-3005/29 Fig.6  
Ø 26 mm

TWS 84-3005/30 Fig.5  
Ø 24 mm

TWS 84-3005/31 Fig.4  
Ø 22 mm

### With cone - socket

### Magnifying



TWS 84-3005/26 Fig.6  
Ø 26 mm

TWS 84-3005/27 Fig.5  
Ø 24 mm

TWS 84-3005/28 Fig.4  
Ø 22 mm



TW Surgical

# Mirror Handle, Mouth Mirrors



TWS 84-3005/31



TWS 84-3005/32



TWS 84-3005/33



TWS 84-3005/34



TWS 84-3005/35



TWS 84-3005/36



TWS 84-3005/29  
Parallelometer  
mouth mirror

TWS 84-3005/30  
Parallelometer  
mouth mirror  
+ handle  
code 2101



TWS 84-3005/37  
Tactile Tone  
Single Ended



TWS 84-3005/38  
Handle  
Thompson  
Single Ended



TWS 84-3005/39  
Hollow Handle



TWS 84-3005/40  
Hollow Handle  
Stainless  
Steel



TWS 84-3005/41  
Cone-socket  
Hollow Handle



TWS 84-3005/42  
Hollow Handle



TWS 84-3005/43  
Hollow Handle

Treasure Wright (U.K.) Ltd.

128-160 City Road, London, EC1V 2NX, United Kingdom  
info@twrightmedical.com



TW Surgical

# Scalers

## SCALERS - JAQUETTE



TWS 84-3005/44

Fig.1

TWS 84-3005/45 1Y-1Y  
TWS 84-3005/46 1Y-1YS  
TWS 84-3005/47 2Y-3Y  
TWS 84-3005/48 2YS-3YS  
TWS 84-3005/49 2-3  
2S-3S

## SCALERS - OCTAGONAL

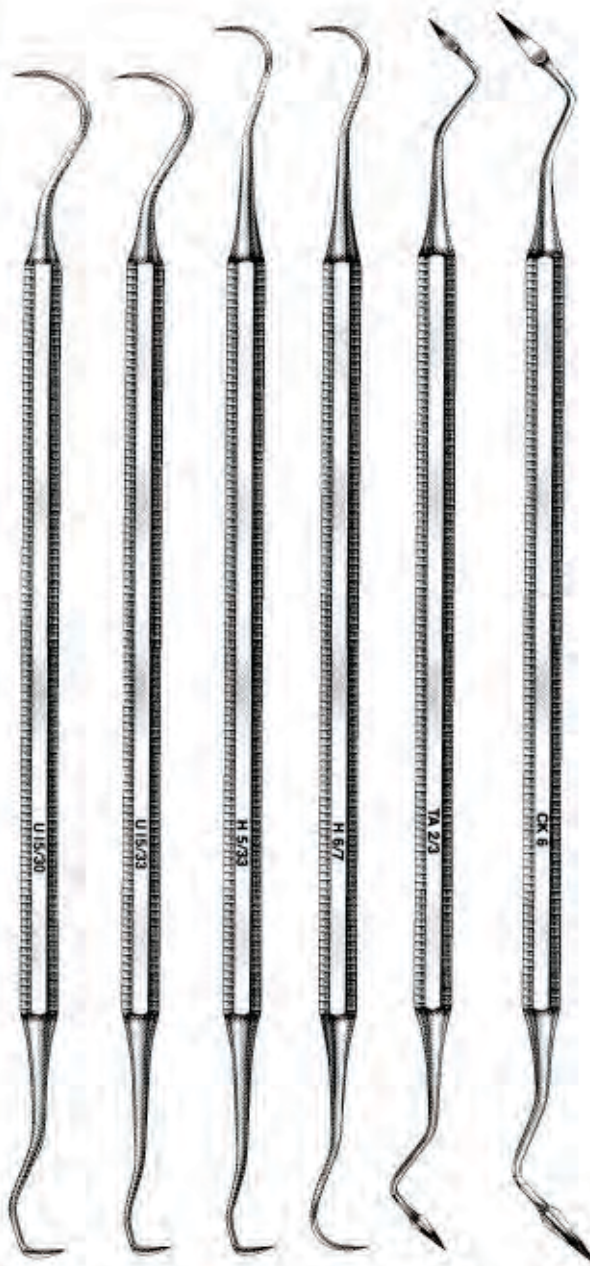

TWS 84-3005/50 U15-30  
TWS 84-3005/51 U15-33  
TWS 84-3005/52 H5-33  
TWS 84-3005/53 H6-7  
Taylor 2-3  
CK6



TW Surgical

## Scalers



TWS 84-3005/54  
U15



TWS 84-3005/55  
No. 3



TWS 84-3005/56  
No. 12



TWS 84-3005/57  
WHITESIDE 1-0



TWS 84-3005/58  
WHITESIDE 2-0

**Treasure Wright (U.K.) Ltd.**

128-160 City Road, London, EC1V 2NX, United Kingdom  
info@twrightmedical.com



TW Surgical

## Scalers



TWS 84-3005/59  
YAOUNGER/GOOD  
7-8



TWS 84-3005/60  
H5-33



TWS 84-3005/61  
204SD



TWS 84-3005/62  
H6-7



TWS 84-3005/63  
204S



TWS 84-3005/64  
TOWNER/JAQUETTE  
U15-30

Treasure Wright (U.K.) Ltd.

128-160 City Road, London, EC1V 2NX, United Kingdom  
info@twrightmedical.com



TW Surgical

# Scalers



TWS 84-3005/65  
JAQUETTE (33-U15)



TWS 84-3005/66  
JAQUETTE  
2Y-3Y



TWS 84-3005/67  
JAQUETTE  
30-U15



1571  
JAQUETTE  
2YS-3YS



1572  
JAQUETTE  
33-H5



TWS 84-3005/68  
YOUNGER/GOOD  
7-8



TWS 84-3005/69  
204S



TWS 84-3005/70  
204SD



TWS 84-3005/71  
H6-7



TWS 84-3005/72  
JAQUETTE  
2S-3S



TWS 84-3005/73  
JAQUETTE  
1Y-1YS



TWS 84-3005/74  
JAQUETTE  
2-3

Treasure Wright (U.K.) Ltd.

128-160 City Road, London, EC1V 2NX, United Kingdom  
info@twrightmedical.com



TW Surgical

# Scalers



TWS 84-3005/75  
JAQUETTE (33-U15)

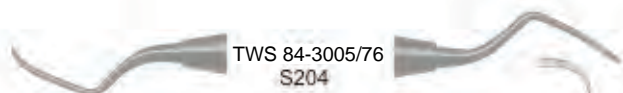

TWS 84-3005/76  
S204

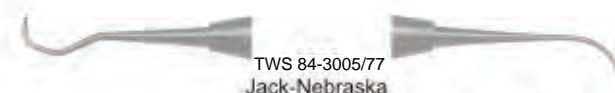

TWS 84-3005/77  
Jack-Nebraska

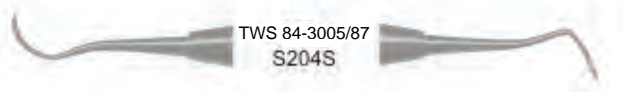

TWS 84-3005/87  
S204S

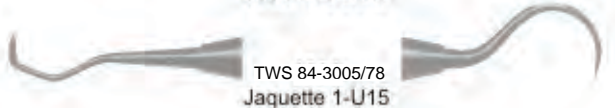

TWS 84-3005/78  
Jaquette 1-U15

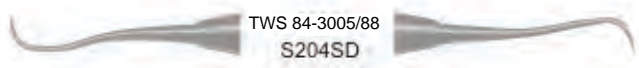

TWS 84-3005/88  
S204SD

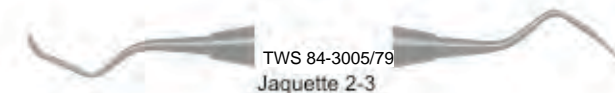

TWS 84-3005/79  
Jaquette 2-3

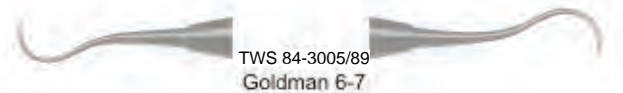

TWS 84-3005/89  
Goldman 6-7

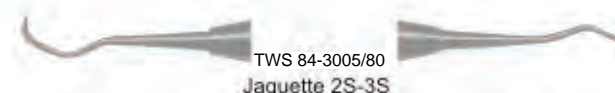

TWS 84-3005/80  
Jaquette 2S-3S

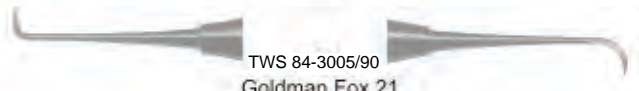

TWS 84-3005/90  
Goldman Fox 21

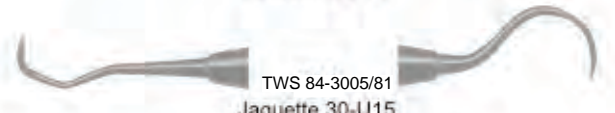

TWS 84-3005/81  
Jaquette 30-U15

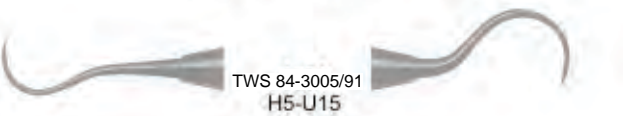

TWS 84-3005/91  
H5-U15

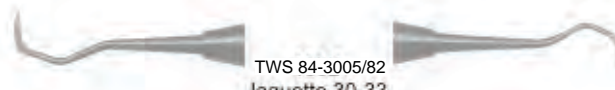

TWS 84-3005/82  
Jaquette 30-33

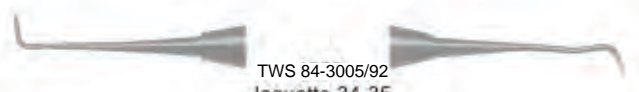

TWS 84-3005/92  
Jaquette 34-35

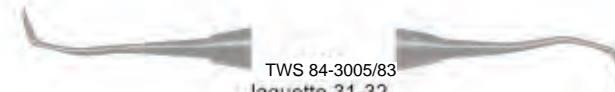

TWS 84-3005/83  
Jaquette 31-32

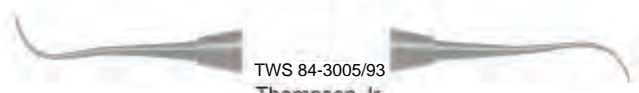

TWS 84-3005/93  
Thompson Jr.

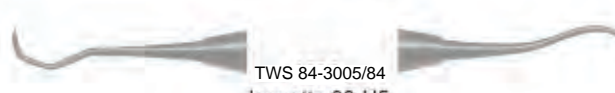

TWS 84-3005/84  
Jaquette 33-H5

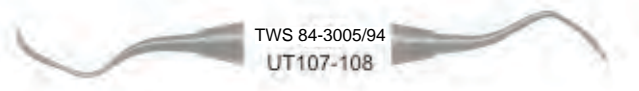

TWS 84-3005/94  
UT107-108

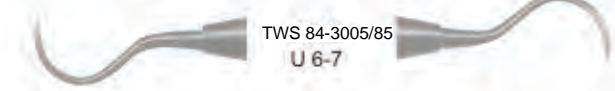

TWS 84-3005/85  
U 6-7

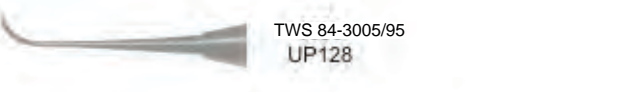

TWS 84-3005/95  
UP128



TWS 84-3005/86  
128L

Treasure Wright (U.K.) Ltd.

128-160 City Road, London, EC1V 2NX, United Kingdom  
info@twrightmedical.com



TW Surgical

# Explorers

## Explorers Double Ended - Octagonal

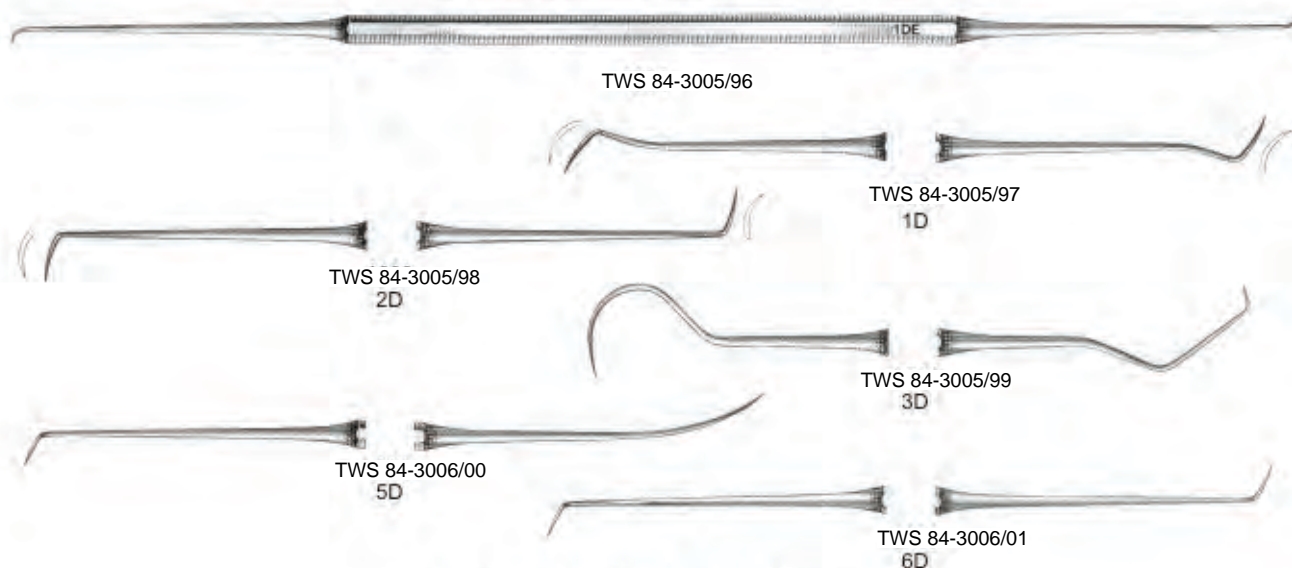

## Explorers Double Ended - Standard

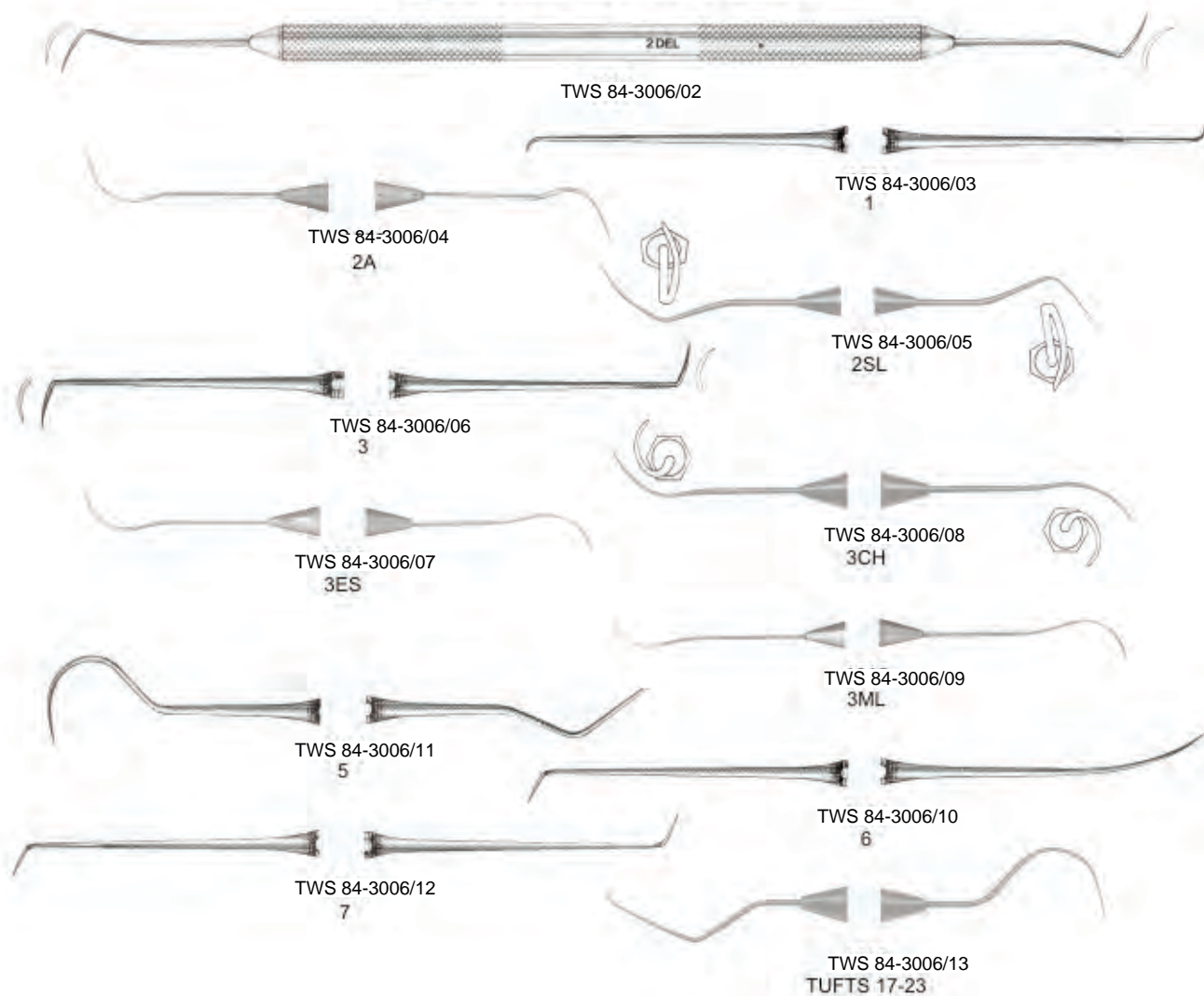

Treasure Wright (U.K.) Ltd.

128-160 City Road, London, EC1V 2NX, United Kingdom  
info@twrightmedical.com



TW Surgical

# Explorers

## Explorers Double Ended Tactile Tone



TWS 84-3006/14  
2A



TWS 84-3006/15  
2



TWS 84-3006/16  
1



TWS 84-3006/17  
2SL



TWS 84-3006/18  
3



TWS 84-3006/19  
3CH



TWS 84-3006/20  
3ES



TWS 84-3006/21  
3ML



TWS 84-3006/22  
5



TWS 84-3006/23  
6



TWS 84-3006/24  
7



TWS 84-3006/25  
16



TWS 84-3006/26  
TUFTS 17/23

Treasure Wright (U.K.) Ltd.

128-160 City Road, London, EC1V 2NX, United Kingdom  
info@twrightmedical.com



TW Surgical

# Explorers & Probes

## Explorers Single Ended - Octagonal

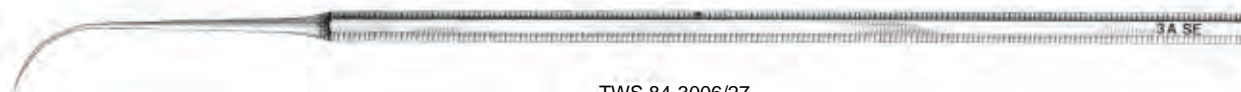

TWS 84-3006/27  
Fig. 3A



TWS 84-3006/28  
Fig. 6



TWS 84-3006/29  
Fig. 7



TWS 84-3006/30  
Fig. 17



TWS 84-3006/31  
Fig. 23

## Explorers Single Ended - Standard



TWS 84-3006/32  
Fig. 3A



TWS 84-3006/33  
Fig. 6



TWS 84-3006/34  
Fig. 7



TWS 84-3006/35  
Fig. 17



TWS 84-3006/36  
Fig. 23

## Probe / Explorer - Octagonal



TWS 84-3006/37  
GF-17

## Double Ended Probe - Octagonal



TWS 84-3006/38  
GF-18 (1-2)

Treasure Wright (U.K.) Ltd.

128-160 City Road, London, EC1V 2NX, United Kingdom  
info@twrightmedical.com

# Probes

## Probes Double Ended - Standard

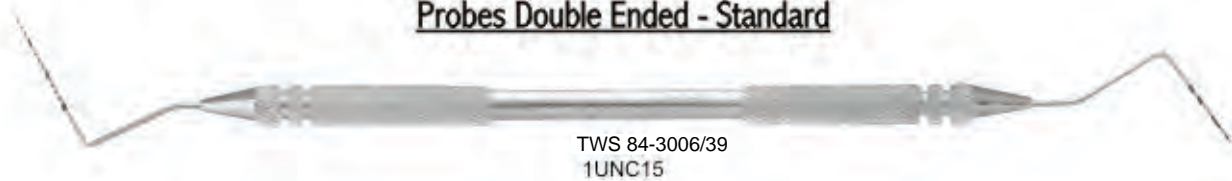

## Probes Double Ended - Tactile Tone

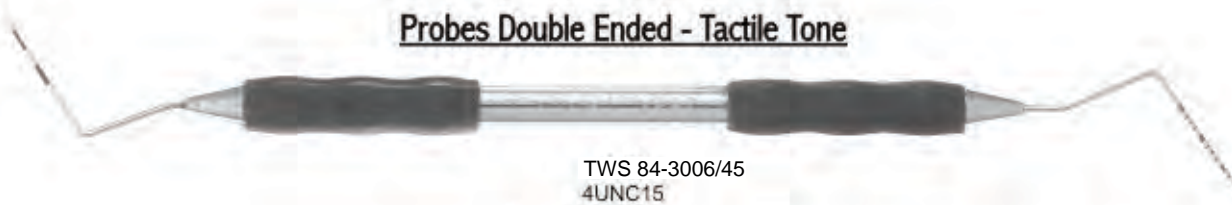



TW Surgical

# Probes

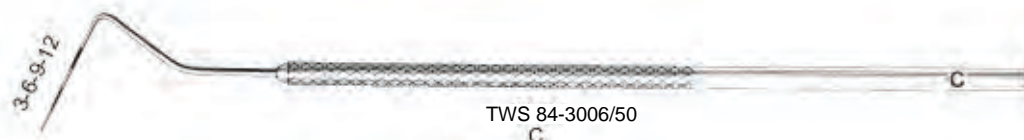

TWS 84-3006/50  
C

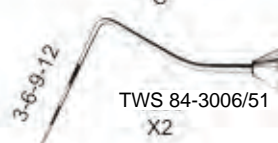

TWS 84-3006/51  
X2

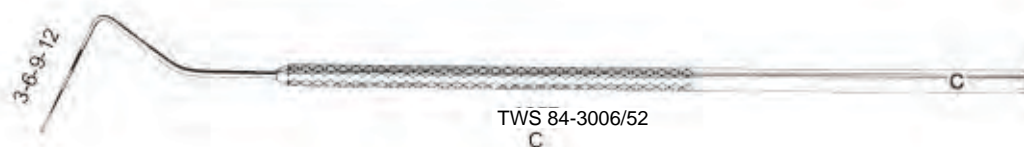

TWS 84-3006/52  
C

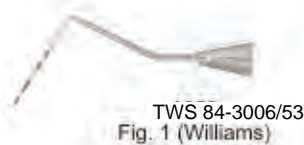

TWS 84-3006/53  
Fig. 1 (Williams)

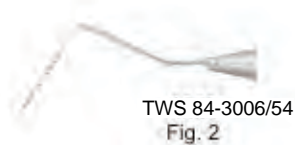

TWS 84-3006/54  
Fig. 2

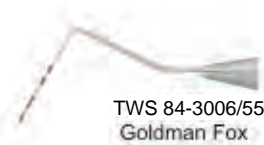

TWS 84-3006/55  
Goldman Fox

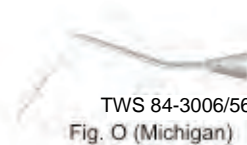

TWS 84-3006/56  
Fig. O (Michigan)

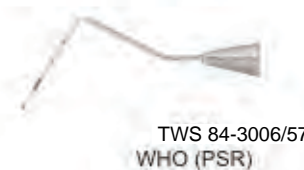

TWS 84-3006/57  
WHO (PSR)

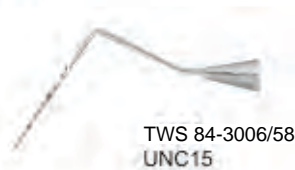

TWS 84-3006/58  
UNC15



TWS 84-3006/59  
X2



TWS 84-3006/60  
Fig. 1 (Williams)



TWS 84-3006/61  
Goldman Fox

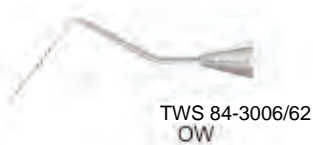

TWS 84-3006/62  
OW

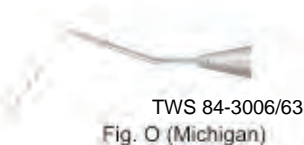

TWS 84-3006/63  
Fig. O (Michigan)



TWS 84-3006/64  
UNC15

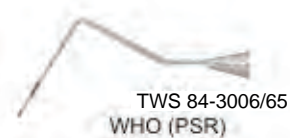

TWS 84-3006/65  
WHO (PSR)



TWS 84-3006/66  
X2

Treasure Wright (U.K.) Ltd.

128-160 City Road, London, EC1V 2NX, United Kingdom  
info@twrightmedical.com



TW Surgical

# Probes

## PROBES DOUBLE ENDED STANDARD



TWS 84-3006/68  
0-23



TWS 84-3006/67  
0W23



TWS 84-3006/70  
PE1-23(1-23)



TWS 84-3006/72  
WHO23



TWS 84-3006/69  
4-23



TWS 84-3006/71  
UNC15-23

## PROBES DOUBLE ENDED TACTILE TONE



TWS 84-3006/73  
0-23



TWS 84-3006/74  
0W23



TWS 84-3006/76  
PE1-23(1-23)



TWS 84-3006/75  
4-23



TWS 84-3006/77  
UNC15-23



TWS 84-3006/78  
WHO23

Treasure Wright (U.K.) Ltd.

128-160 City Road, London, EC1V 2NX, United Kingdom  
info@twrightmedical.com



TW Surgical

# Endodontic Condensers

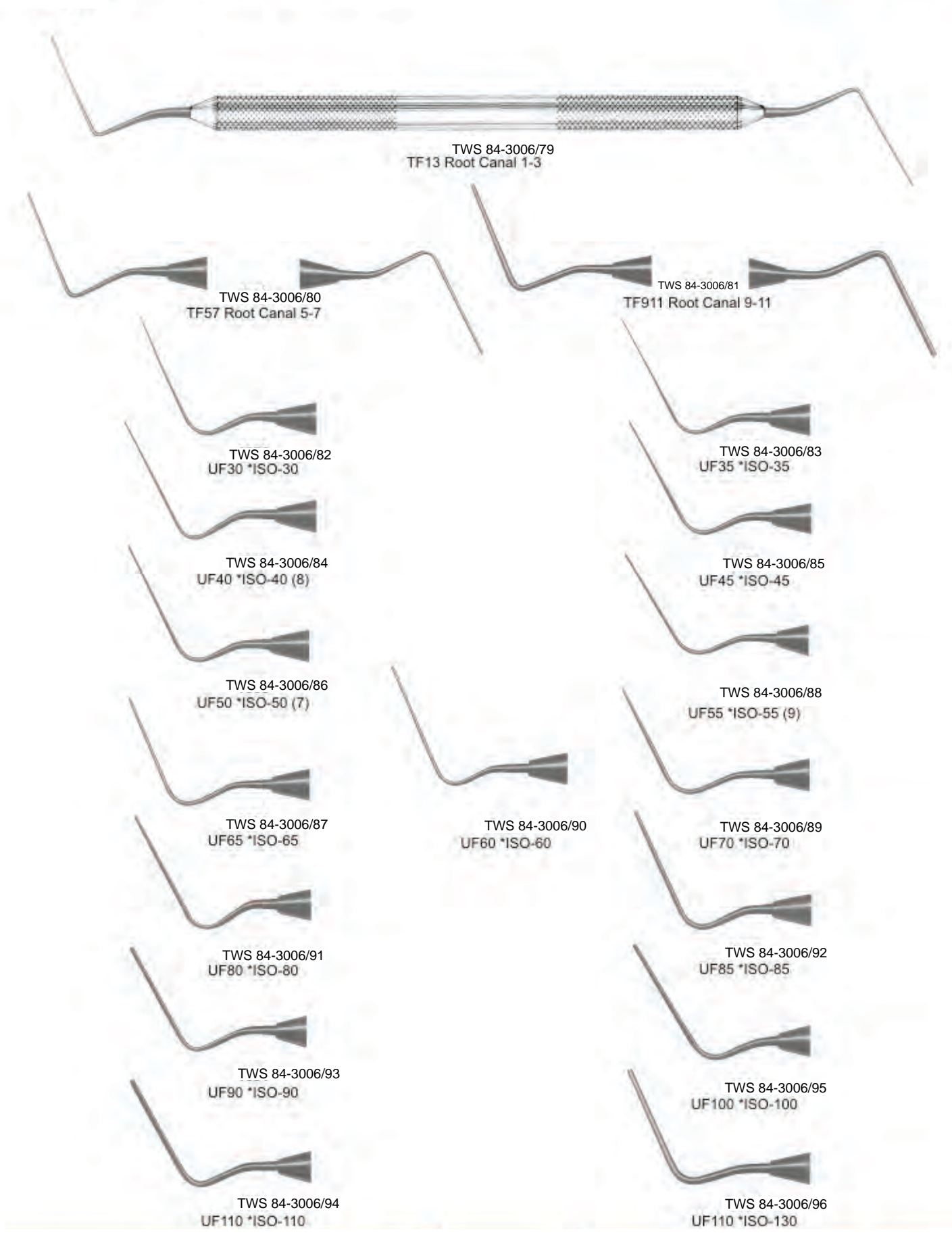

Treasure Wright (U.K.) Ltd.

128-160 City Road, London, EC1V 2NX, United Kingdom  
info@twrightmedical.com



TW Surgical

## Endodontic Condensers/Spreaders



TWS 84-3006/97  
UF120X



TWS 84-3006/98  
UF45N



TWS 84-3006/99  
UF60N



TWS 84-3007/00  
UF80N



TWS 84-3007/01  
UF100X



TWS 84-3007/02  
UE25 R-25



TWS 84-3007/03  
UE30 R-30



TWS 84-3007/04  
UE35 R-35



TWS 84-3007/05  
UE40 R-40



TWS 84-3007/06  
UE45 R-45



TWS 84-3007/07  
UE50 R-50



TWS 84-3007/08  
UF120X



TWS 84-3007/09  
UF140X



TWS 84-3007/10  
TFD3545N



TWS 84-3007/11  
TFD6080N



TWS 84-3007/12  
UE55 R-55



TWS 84-3007/13  
UE60 R-60



TWS 84-3007/14  
UE25N R-25



TWS 84-3007/15  
UE30N R-30



TWS 84-3007/16  
UE40N R-40

Treasure Wright (U.K.) Ltd.

128-160 City Road, London, EC1V 2NX, United Kingdom  
info@twrightmedical.com



TW Surgical

# Obturation Instruments

TWS 84-3007/17  
No. D11



D1 .33mm, D16 .95mm

TWS 84-3007/18  
No. D11T



D1 .24mm, D2 .84mm

TWS 84-3007/19  
No. KR1



D1 .23mm, D2 .61mm

TWS 84-3007/20  
No. 25S



D1 .26mm, D2 .53mm

TWS 84-3007/21  
No. W1S



D1 .25mm, D16 .55mm

TWS 84-3007/22  
No. W2S



D1 .40mm, D2 .70mm



TWS 84-3007/23  
Lucks No.1



TWS 84-3007/24  
Lucks No.2



TWS 84-3007/25  
Lucks No.3



TWS 84-3007/26  
Lucks No.4

TWS 84-3007/27  
No. 5, D(1mm).50mm, .55mm D(5mm)  
D(16mm), 85mm, .75mm D(16mm)



TWS 84-3007/28  
No. 7, D(1mm).70mm, .50mm D(5mm)  
D(16mm), 1.00mm, .75mm D(16mm)



TWS 84-3007/29  
No. 9, D(1mm)1.00mm, .63mm D(5mm)  
D(16mm), 1.30mm, .75mm D(16mm)



TWS 84-3007/30  
No. 11, D(1mm)1.20mm, .63mm D(5mm)  
D(16mm), 1.50mm, .75mm D(16mm)

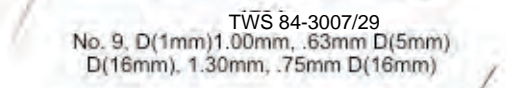

TWS 84-3007/31  
No.1 (D1 .35mm, D16 .75mm)



TWS 84-3007/32  
No.2 D1 .55mm, D16 .85mm



TWS 84-3007/33  
No.3 D1 .85mm, D16 1.15mm



TWS 84-3007/34  
No.4 D1 1.00mm, D16 1.30mm



TWS 84-3007/35  
No.1-3 - D1 .25mm/D1 .35mm



TWS 84-3007/36  
No.3-5 - D1 .35mm/D1 .55mm



TWS 84-3007/37  
No.5-7 - D1 .55mm/D1 .70mm

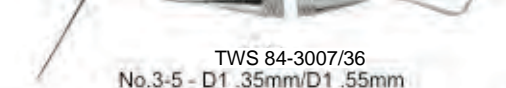

TWS 84-3007/38  
No.9-11 - D1 1.00mm/D1 1.20mm



Treasure Wright (U.K.) Ltd.

128-160 City Road, London, EC1V 2NX, United Kingdom  
info@twrightmedical.com



TW Surgical

# Excavators

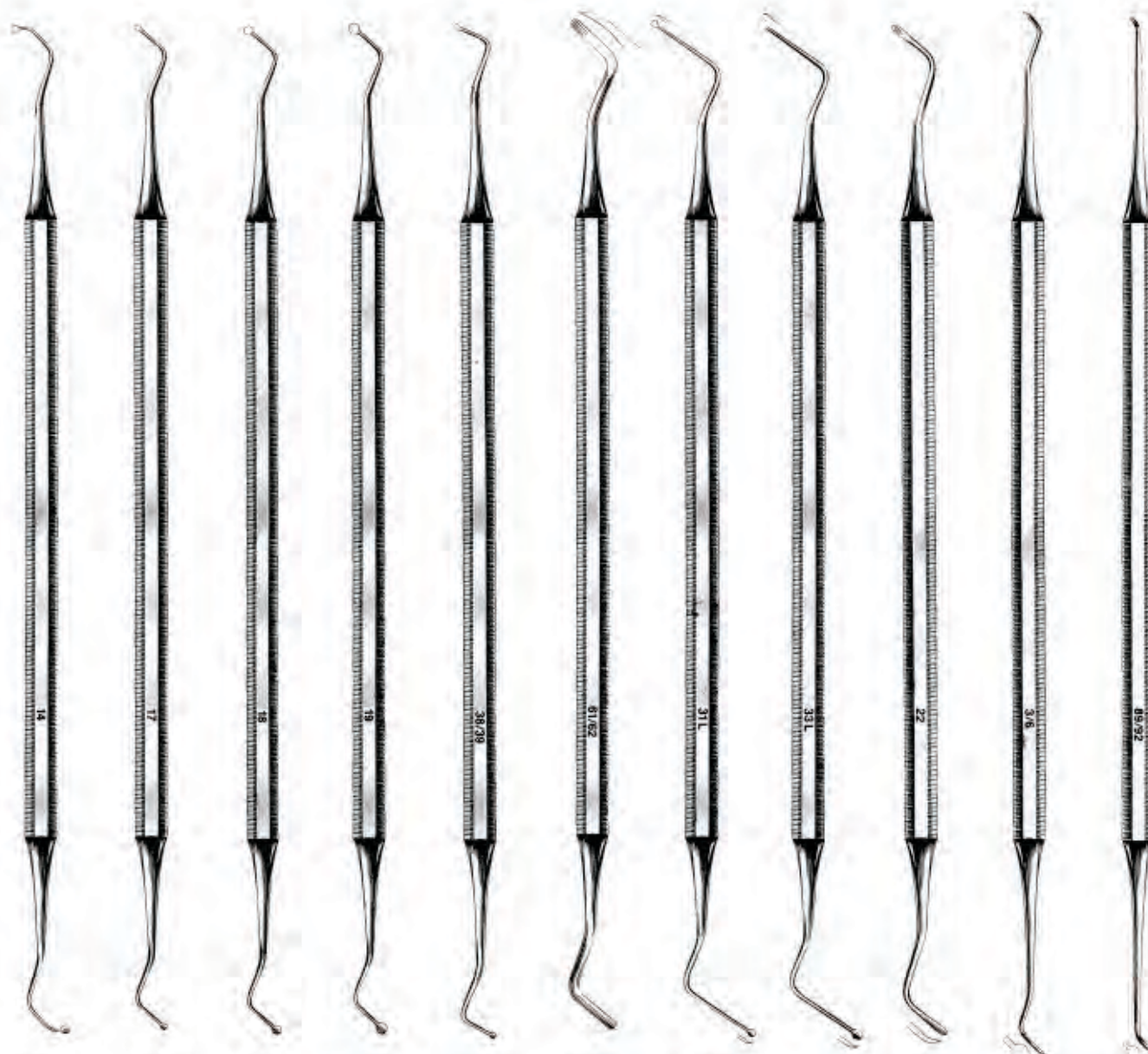

TWS 84-3007/39 No. 14    TWS 84-3007/39 No. 17    TWS 84-3007/40 No. 18    TWS 84-3007/41 No. 19    TWS 84-3007/42 No. 38/639    TWS 84-3007/43 No. 61/62    TWS 84-3007/44 No. 31L    TWS 84-3007/45 No. 33L    TWS 84-3007/46 No. 22    TWS 84-3007/47 No. 3/6    TWS 84-3007/48 No. 89/92

Treasure Wright (U.K.) Ltd.

128-160 City Road, London, ECLV 2NX, United Kingdom  
info@twrightmedical.com

# Excavators



TWS 84-3007/49  
1mm Discoid (10-7-14)



TWS 84-3007/50  
1mm Discoid (38-39) (11.5-7-14)



TWS 84-3007/51  
E2 Discoid (15-9-15)



TWS 84-3007/52  
1.5mm Discoid (15-8-14)



TWS 84-3007/53  
E3 Discoid (25-9-15)



TWS 84-3007/54  
2mm Discoid (20-9-14)



TWS 84-3007/58  
1.5mm Spoon (15-8-14)



TWS 84-3007/55  
E1 Discoid (12-9-15)



TWS 84-3007/59  
2mm Spoon (20-9-14)



TWS 84-3007/56  
17 Tear-Drop



TWS 84-3007/60  
19 Tear-Drop



TWS 84-3007/57  
18 Tear-Drop



TWS 84-3007/61  
20 Tear-Drop





TW Surgical

## Excavators, Explorer / Probes

### Excavators



TWS 84-3007/62  
31L

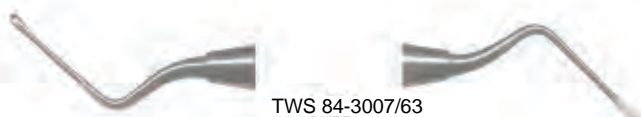

TWS 84-3007/63  
31W



TWS 84-3007/64  
33L

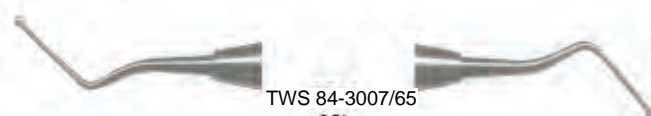

TWS 84-3007/65  
32L

### Explorers / Probes



TWS 84-3007/67  
G16D-L



TWS 84-3007/68  
Explorer No.2



TWS 84-3007/69  
Explorer No.16



TWS 84-3007/66  
16-23 Explorer



TWS 84-3007/70  
16-17 Explorer



TWS 84-3007/71  
DG16 Explorer

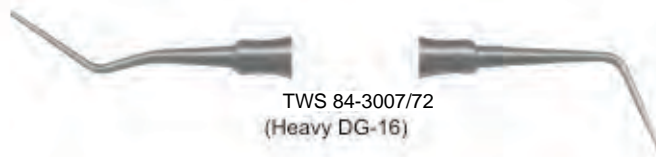

TWS 84-3007/72  
(Heavy DG-16)

Treasure Wright (U.K.) Ltd.

128-160 City Road, London, EC1V 2NX, United Kingdom  
info@twrightmedical.com



TW Surgical

# Explorers



TWS 84-3007/73 1D  
TWS 84-3007/74 2D  
TWS 84-3007/75 3D  
TWS 84-3007/76 5D  
TWS 84-3007/77 6D  
TWS 84-3007/78 7D

TWS 84-3007/78 3A-S  
TWS 84-3007/79 6S  
TWS 84-3007/80 7S  
TWS 84-3007/81 17S  
TWS 84-3007/81 23S

Treasure Wright (U.K.) Ltd.

128-160 City Road, London, EC1V 2NX, United Kingdom  
info@twrightmedical.com



TW Surgical

# Explorers

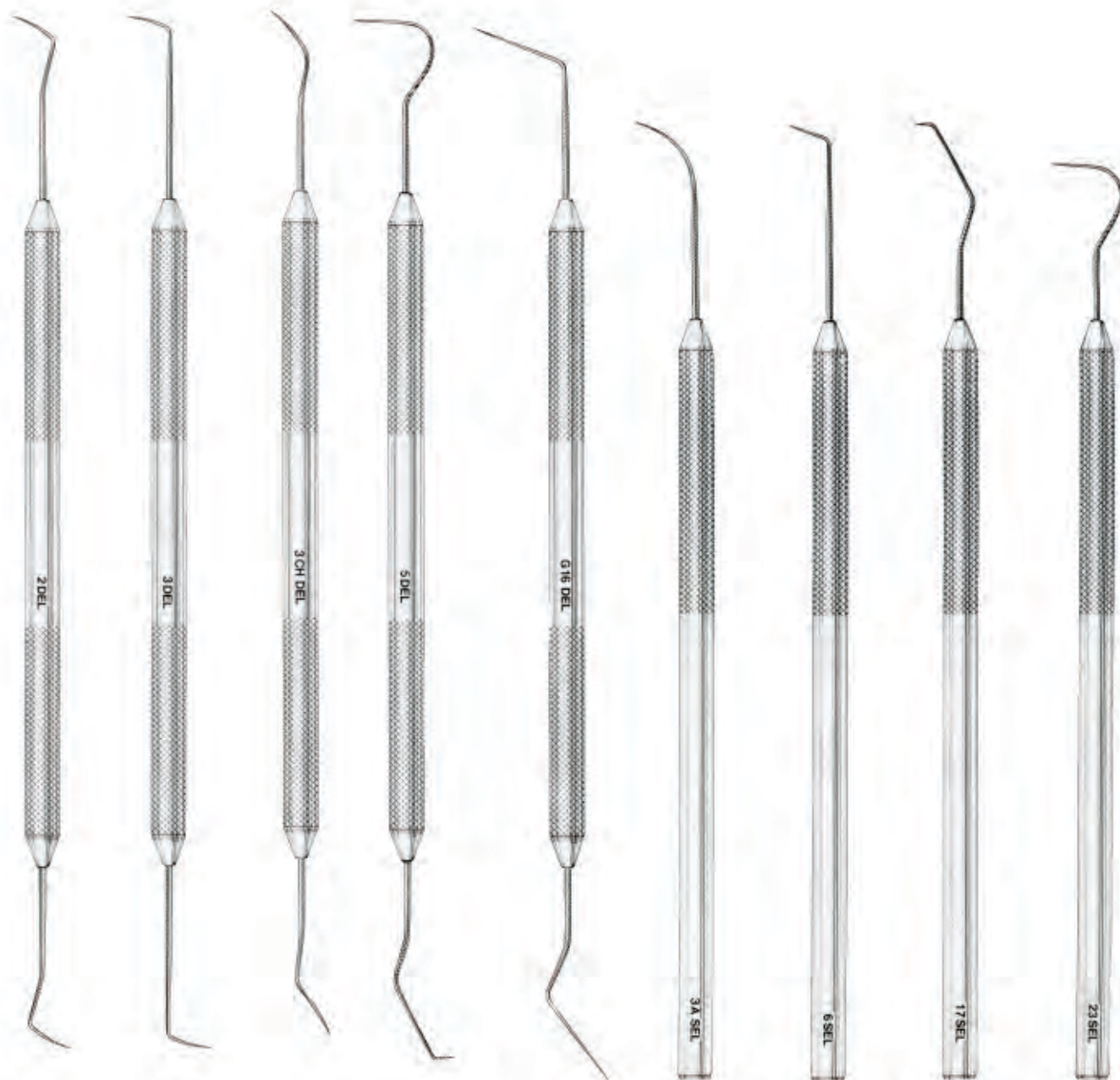

TWS 84-3007/82 No. 2D-L    TWS 84-3007/83 No. 3D-L    TWS 84-3007/84 No. 3CHD-L    TWS 84-3007/85 No. 5D-L    TWS 84-3007/86 No. G16D-L    TWS 84-3007/87 No. 3AS-L    TWS 84-3007/88 No. 6S-L    TWS 84-3007/89 No. 17S-L    TWS 84-3007/90 No. 23S-L

Treasure Wright (U.K.) Ltd.

128-160 City Road, London, EC1V 2NX, United Kingdom  
info@twrightmedical.com



TW Surgical

## Explorer / Probe Combination



TWS 84-3007/91  
Gf17 Probe/Explorer

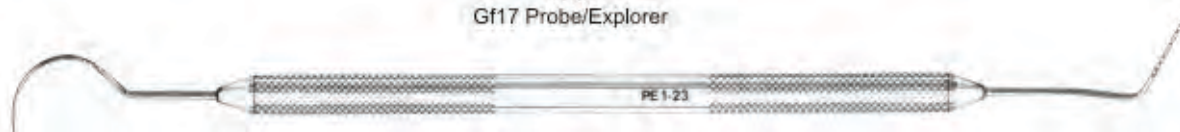

TWS 84-3007/92  
PE 1-23 Probe/Explorer

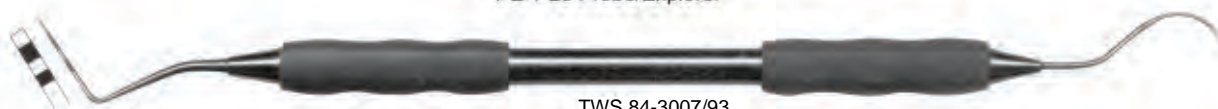

TWS 84-3007/93  
Probe 0 / 23 Explorer (fine)



TWS 84-3007/94  
Probe 1 / 23 Explorer



TWS 84-3007/96  
Probe 4 / 23 Explorer



TWS 84-3007/95  
Probe OW / 23 Explorer



TWS 84-3007/97  
Ball Tip Probe WHO / 23 Explorer

## PROBES



TWS 84-3007/98  
Gf18 Probe

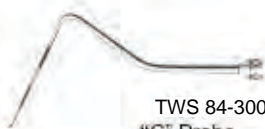

TWS 84-3007/99  
"C" Probe



TWS 84-3008/00  
X2 Probe

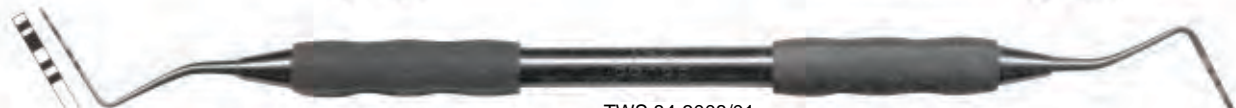

TWS 84-3008/01  
1-2 (Probe 2 end is flat)



TWS 84-3008/02  
1 UNC 15



TWS 84-3008/03  
4 SE

Treasure Wright (U.K.) Ltd.

128-160 City Road, London, EC1V 2NX, United Kingdom  
info@twrightmedical.com



TW Surgical

# Cord Packers, Hatchets, Hoes

## CORD PACKERS



TWS 84-3008/04

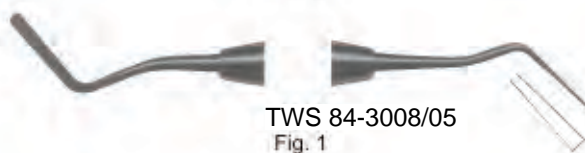

TWS 84-3008/05  
Fig. 1

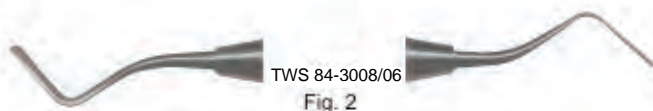

TWS 84-3008/06  
Fig. 2

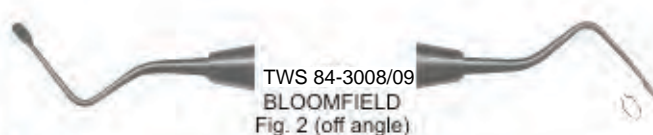

TWS 84-3008/09  
BLOOMFIELD  
Fig. 2 (off angle)

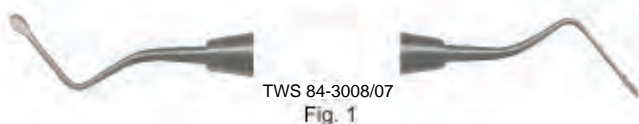

TWS 84-3008/07  
Fig. 1

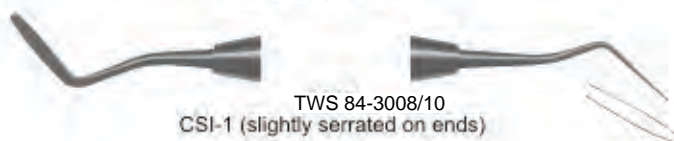

TWS 84-3008/10  
CSI-1 (slightly serrated on ends)

## HATCHETS



TWS 84-3008/08  
1mm (10-7-14)

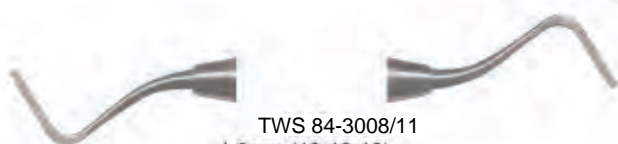

TWS 84-3008/11  
1.3mm (13-10-16)



TWS 84-3008/12  
1.5mm (15-8-14)

## HOES

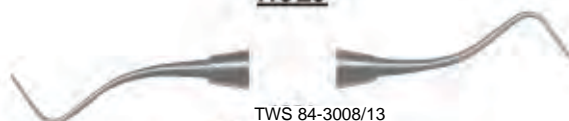

TWS 84-3008/13  
1mm (10-8-16)

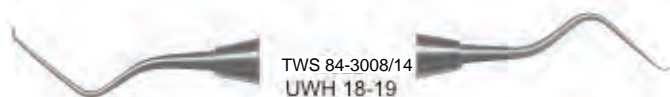

TWS 84-3008/14  
UWH 18-19

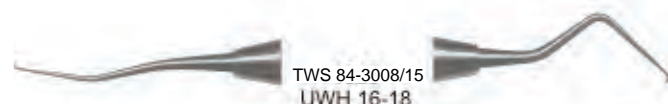

TWS 84-3008/15  
UWH 16-18

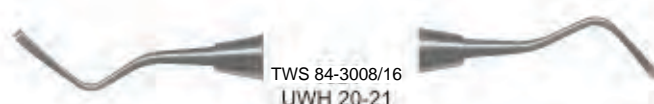

TWS 84-3008/16  
UWH 20-21

Treasure Wright (U.K.) Ltd.

128-160 City Road, London, EC1V 2NX, United Kingdom  
info@twrightmedical.com



TW Surgical

## P.K.Thomas waxing & Gracey Curettes Set



TWS 84-3008/17  
P.K.Thomas 1



TWS 84-3008/18  
P.K.Thomas 2



TWS 84-3008/19  
P.K.Thomas 3



TWS 84-3008/20  
P.K.Thomas 4

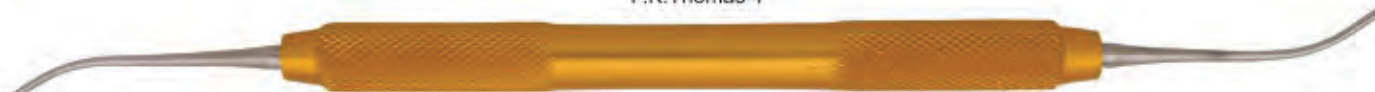

TWS 84-3008/21  
P.K.Thomas 5

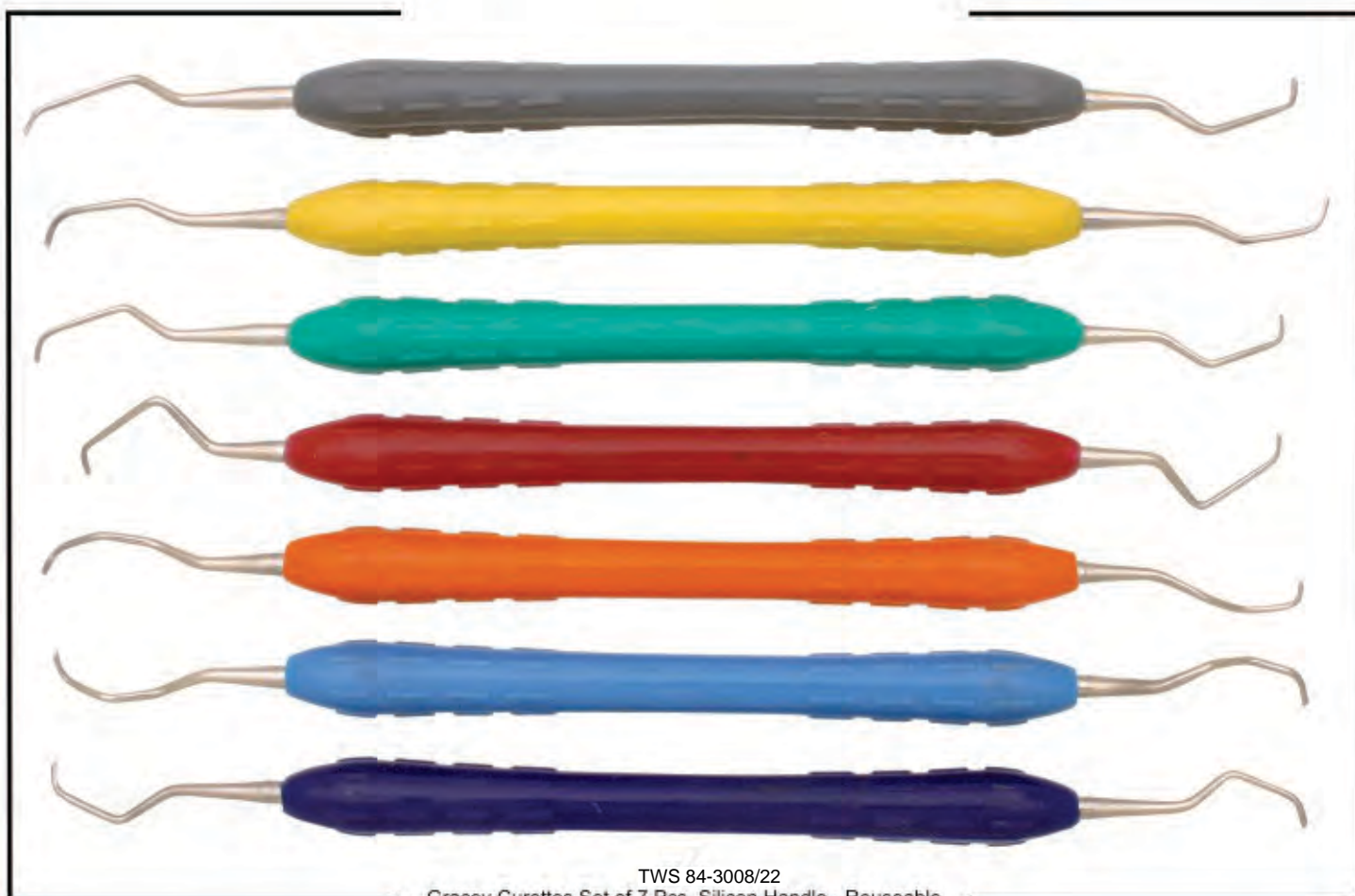

TWS 84-3008/22  
Gracey Curettes Set of 7 Pcs, Silicon Handle - Reuseable

Treasure Wright (U.K.) Ltd.

128-160 City Road, London, EC1V 2NX, United Kingdom  
info@twrightmedical.com



TW Surgical

# Amalgam Pluggers / Condensers / Applicators



TWS 84-3008/23  
BEHRMAN (Fig. 1)



TWS 84-3008/24  
BLACK (Fig. 1-2)



TWS 84-3008/27  
Hollenback No.1 Plugger

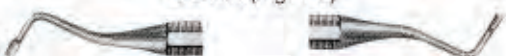

TWS 84-3008/25  
MORQUETTE (Fig. 0/1)



TWS 84-3008/28  
Hollenback No. 2 Plugger

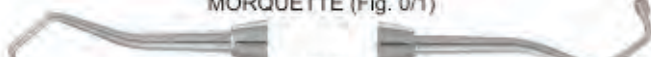

TWS 84-3008/26  
Black Action 11/12 Plugger

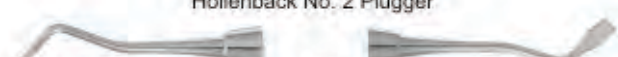

TWS 84-3008/29  
Hollenback No. 3 Plugger



TWS 84-3008/30  
Blacks 0-1 (1mm-1.5mm)



TWS 84-3008/31  
Blacks 1-2 (1.5mm-2.5mm)

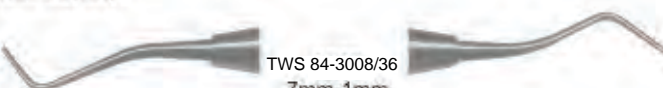

TWS 84-3008/36  
.7mm-1mm

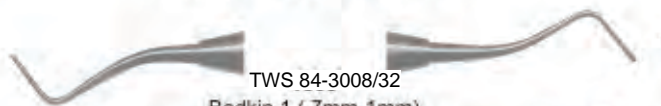

TWS 84-3008/32  
Bodkin 1 (.7mm-1mm)

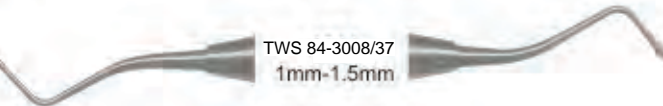

TWS 84-3008/37  
1mm-1.5mm

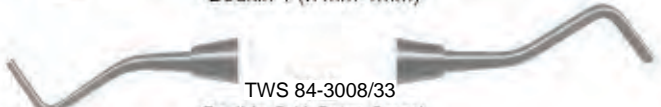

TWS 84-3008/33  
Bodkin 2 (1.5mm-2mm)

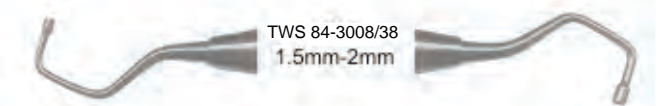

TWS 84-3008/38  
1.5mm-2mm

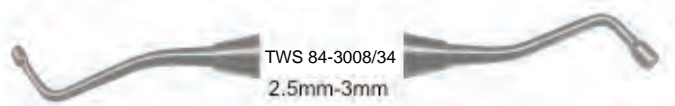

TWS 84-3008/34  
2.5mm-3mm

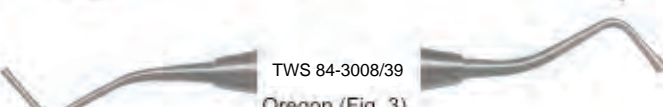

TWS 84-3008/39  
Oregon (Fig. 3)

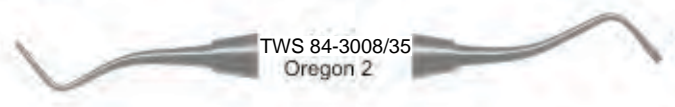

TWS 84-3008/35  
Oregon 2

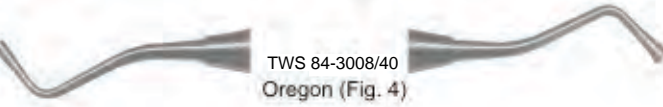

TWS 84-3008/40  
Oregon (Fig. 4)

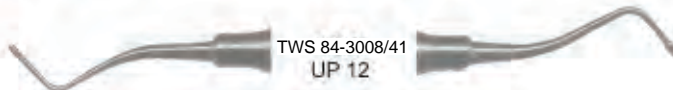

TWS 84-3008/41  
UP 12

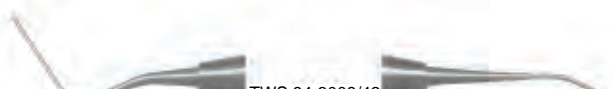

TWS 84-3008/42  
Applicator 1-2



TWS 84-3008/43  
Birtles Applicator Spatula



TWS 84-3008/44  
Birtles Applicator Spatula K

Treasure Wright (U.K.) Ltd.

128-160 City Road, London, EC1V 2NX, United Kingdom  
info@twrightmedical.com



TW Surgical

## Placement Instruments, Stopping Stoppers, Plugg

### Placement Instruments



TWS 84-3008/45  
PICH (Calcium Hydroxide Placer)



TWS 84-3008/46  
CA

### Stopping Stoppers



TWS 84-3008/47  
Woodson 2

Ø 1.6 mm



TWS 84-3008/48  
Woodson 3S

Ø 2.4 mm

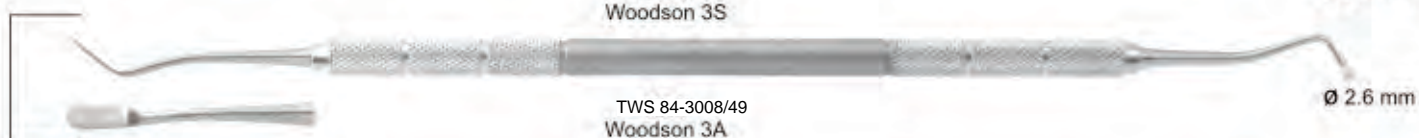

TWS 84-3008/49  
Woodson 3A

Ø 2.6 mm

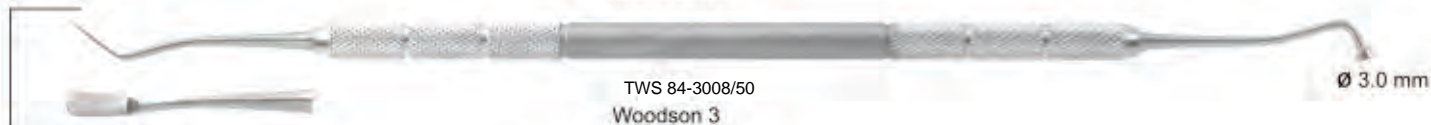

TWS 84-3008/50  
Woodson 3

Ø 3.0 mm

### Pluggers



Ø 0.75 mm

TWS 84-3008/51  
Pluggers 0-1

Ø 1.2 mm

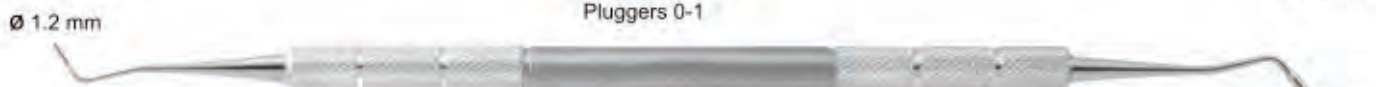

Ø 1.2 mm

TWS 84-3008/52  
Pluggers 1-4

Ø 1.6 mm

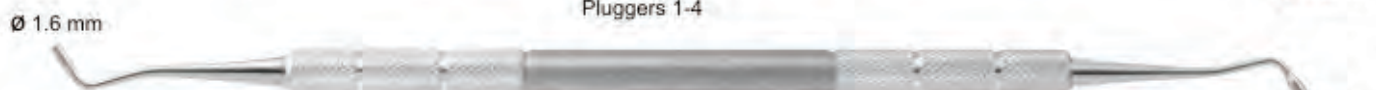

Ø 1.6 mm

TWS 84-3008/53  
Pluggers 4-6

Ø 2.0 mm



Ø 2.0 mm

TWS 84-3008/54  
Pluggers 6-8

Ø 2.5 mm

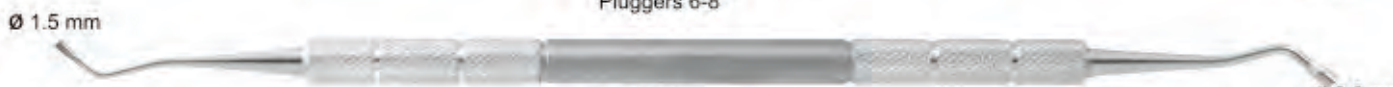

Ø 1.5 mm

TWS 84-3008/55  
Black 1-2

Ø 2.6 mm

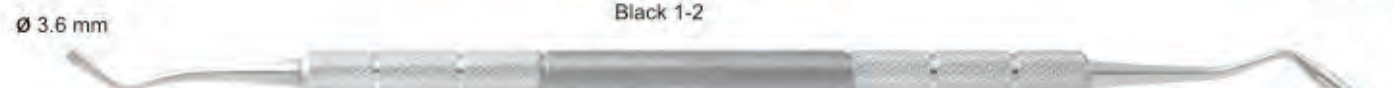

Ø 3.6 mm

TWS 84-3008/56  
Black 2-3

Ø 5.0 mm

Treasure Wright (U.K.) Ltd.

128-160 City Road, London, EC1V 2NX, United Kingdom  
info@twrightmedical.com



TW Surgical

## Burnishers



TWS 84-3008/57  
Fig. 1



TWS 84-3008/58  
Fig. 28/29



TWS 84-3008/59  
Fig. 34



TWS 84-3008/60  
Fig. 27/29



TWS 84-3008/61  
Fig. 21B



TWS 84-3008/62  
ACORN  
Fig. 21

Treasure Wright (U.K.) Ltd.

128-160 City Road, London, EC1V 2NX, United Kingdom  
info@twrightmedical.com



TW Surgical

# Burnishers



TWS 84-3008/63  
21 Acorn

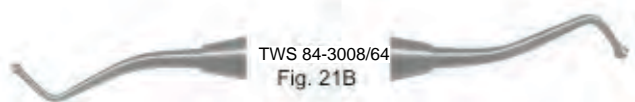

TWS 84-3008/64  
Fig. 21B

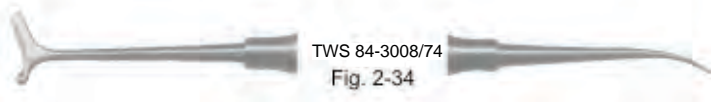

TWS 84-3008/74  
Fig. 2-34

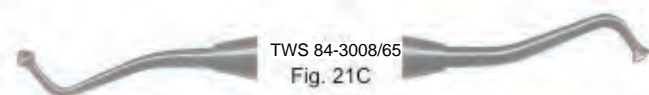

TWS 84-3008/65  
Fig. 21C

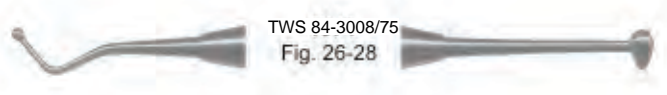

TWS 84-3008/75  
Fig. 26-28

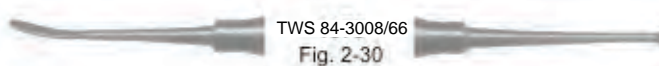

TWS 84-3008/66  
Fig. 2-30

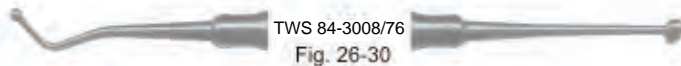

TWS 84-3008/76  
Fig. 26-30

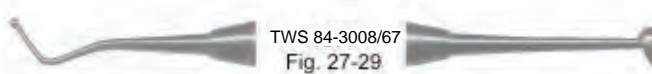

TWS 84-3008/67  
Fig. 27-29

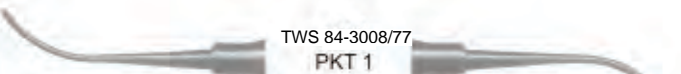

TWS 84-3008/77  
PKT 1

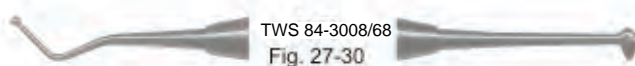

TWS 84-3008/68  
Fig. 27-30

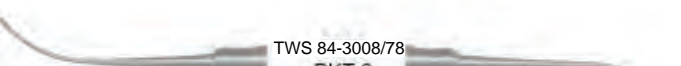

TWS 84-3008/78  
PKT 2



TWS 84-3008/69  
Fig. 34T

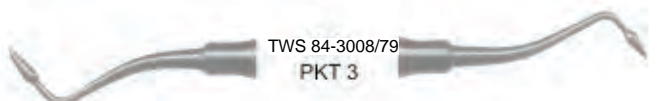

TWS 84-3008/79  
PKT 3

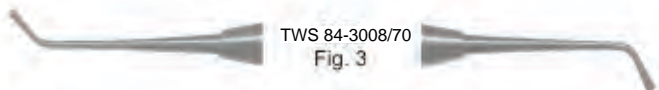

TWS 84-3008/70  
Fig. 3

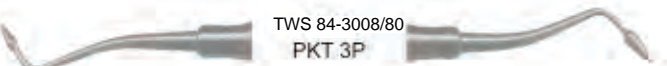

TWS 84-3008/80  
PKT 3P

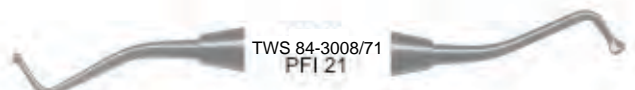

TWS 84-3008/71  
PFI 21

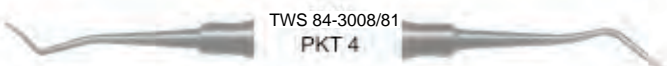

TWS 84-3008/81  
PKT 4

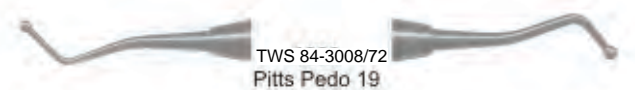

TWS 84-3008/72  
Pitts Pedo 19

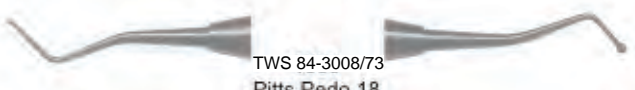

TWS 84-3008/73  
Pitts Pedo 18



TWS 84-3008/82  
PKT 5

Treasure Wright (U.K.) Ltd.

128-160 City Road, London, EC1V 2NX, United Kingdom  
info@twrightmedical.com



TW Surgical

# Wax Carvers



TWS 84-3008/89  
HOLLENBACK  
Fig. 3

TWS 84-3008/83  
HOLLENBACK  
Fig. 3S

TWS 84-3008/84  
WARD  
Fig. 1

TWS 84-3008/85  
WARD  
Fig. 2

TWS 84-3008/85  
WALL  
Fig. 1

TWS 84-3008/86  
WALL  
Fig. 3

TWS 84-3008/87  
Fig. 3/6  
Cleoid/Discoïd

TWS 84-3008/88  
Fig. 89/92  
Cleoid/Discoïd

Treasure Wright (U.K.) Ltd.

128-160 City Road, London, EC1V 2NX, United Kingdom  
info@twrightmedical.com



TW Surgical

# Carvers



TWS 84-3008/90  
1.5mm Cleoid Discoid (Shown with GTX Finish)



TWS 84-3008/91  
2mm Cleoid Discoid



TWS 84-3008/99  
GOLLOBIN  
Fig. 1



TWS 84-3008/92  
3mm Cleoid Discoid



TWS 84-3009/00  
HOLLENBACK  
Fig. 1/2



TWS 84-3008/93  
FRAHM  
Fig. 2-3 (off-angle)

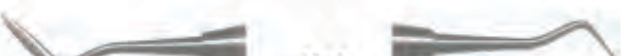

TWS 84-3009/01  
HOLLENBACK  
Fig. 3



TWS 84-3008/94  
Interproximal 1



TWS 84-3009/02  
THOMPSON (Fig. 3)  
( $\frac{1}{2}$  Hollenback Hoe & Wall 3)



TWS 84-3008/95  
Interproximal 1

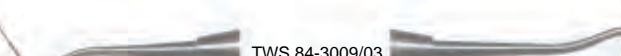

TWS 84-3009/03  
THOMPSON (Fig. 5)  
( $\frac{1}{2}$  Hollenback Hoe & Tanner 5)



TWS 84-3008/96  
Baum Interproximal



TWS 84-3009/04  
THOMPSON (Fig. 8)  
(3mm Cleoid & Wall 3)



TWS 84-3008/97  
Sho A Carver



TWS 84-3009/05  
THOMPSON (Fig. 9)  
(Hollenback 3 & Wall 3)



TWS 84-3008/98  
Thompson 2



TWS 84-3009/06  
WARD  
Fig. 2



TW Surgical

## Carvers, Chisels

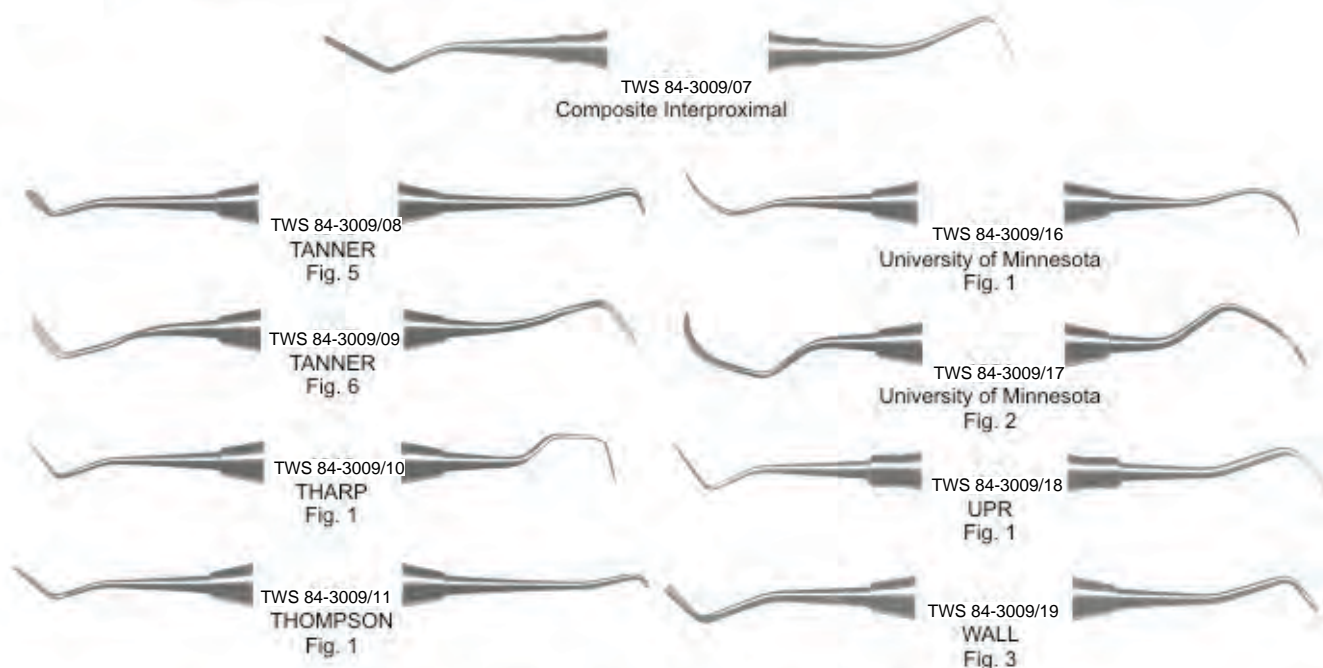

### Contour Carbide Carvers - Finishing



### Chisels

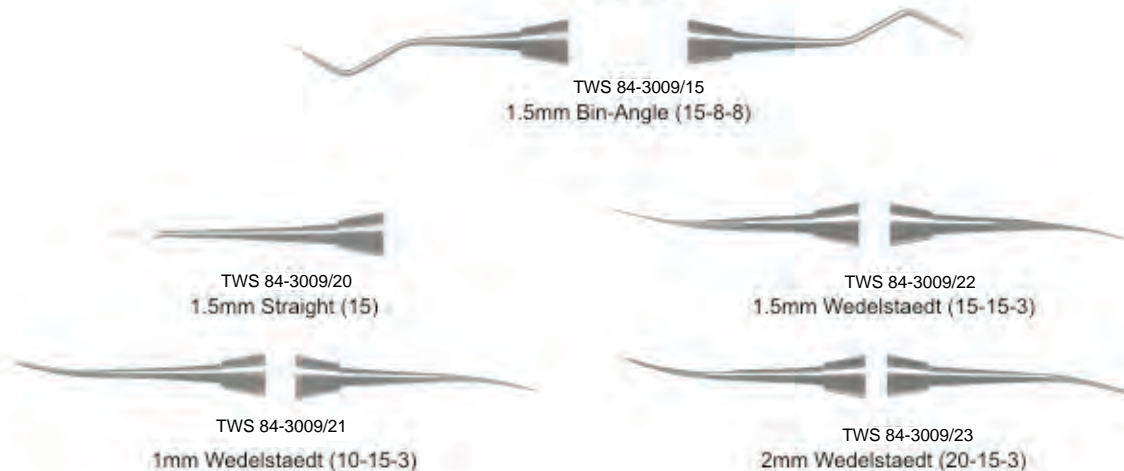

Treasure Wright (U.K.) Ltd.

128-160 City Road, London, EC1V 2NX, United Kingdom  
info@twrightmedical.com



TW Surgical

## Composite Placement



TWS 84-3009/24 F-Type 1    TWS 84-3009/25 F-Type 2    TWS 84-3009/26 F-Type 3    TWS 84-3009/27 F-Type 4    TWS 84-3009/28 F-Type 5    TWS 84-3009/29 F-Type 6    TWS 84-3009/30 G-Type 1    TWS 84-3009/31 G-Type 2    TWS 84-3009/32 G-Type 3    TWS 84-3009/33 G-Type 4

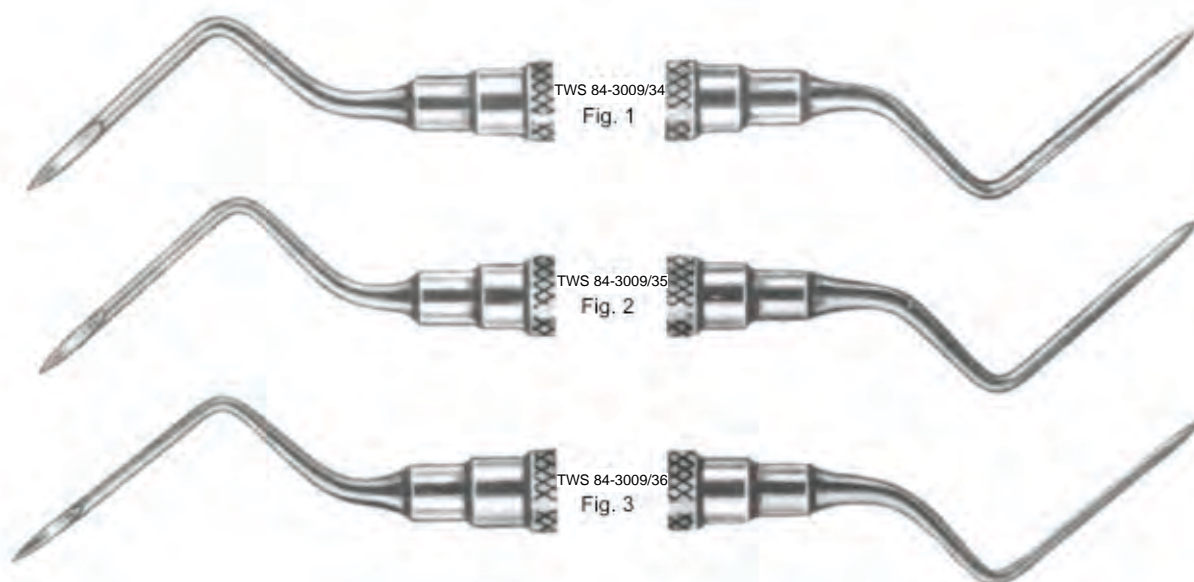

Treasure Wright (U.K.) Ltd.

128-160 City Road, London, EC1V 2NX, United Kingdom  
info@twrightmedical.com



TW Surgical

# Composite Placement



TWS 84-3009/37  
Fig. 2



TWS 84-3009/38  
Fig. 3 (off-set blade)



TWS 84-3009/46  
Fig. 12



TWS 84-3009/39  
Fig. 4



TWS 84-3009/47  
Fig. 15



TWS 84-3009/40  
Fig. 5



TWS 84-3009/48  
JORDAN  
Fig. 2



TWS 84-3009/41  
Fig. 6



TWS 84-3009/49  
FREEDMAN  
Fig. 1



TWS 84-3009/42  
Fig. 7



TWS 84-3009/50  
FREEDMAN  
Fig. 2



TWS 84-3009/43  
Fig. 8



TWS 84-3009/51  
FREEDMAN  
Fig. 3



TWS 84-3009/44  
Fig. 9



TWS 84-3009/52  
Dr. Dan



TWS 84-3009/45  
Fig. 11



TWS 84-3009/53  
SIMON  
Fig. 2



## K - Type



1962  
K-Type 1



TWS 84-3009/57  
K-Type 2



TWS 84-3009/54  
K-Type 4



TWS 84-3009/58  
K-Type 3



TWS 84-3009/55  
K-Type 5



TWS 84-3009/56  
K-Type 6 Carbide

Treasure Wright (U.K.) Ltd.

128-160 City Road, London, EC1V 2NX, United Kingdom  
info@twrightmedical.com



TW Surgical

## Plastic Filling Instruments



TWS 84-3009/59  
No.3

TWS 84-3009/60  
No.4

TWS 84-3009/61  
No.5

TWS 84-3009/62  
LADMORE  
Fig. 3

TWS 84-3009/63  
WOODSON  
Fig. 1

TWS 84-3009/64  
WOODSON  
Fig. 2

TWS 84-3009/65  
WOODSON  
Fig. 3

TWS 84-3009/66  
W-3

TWS 84-3009/67  
Gregg  
4/5

Treasure Wright (U.K.) Ltd.

128-160 City Road, London, EC1V 2NX, United Kingdom  
info@twrightmedical.com



TW Surgical

# Plastic Filling Instruments



TWS 84-3009/68  
Fig. 5-7



TWS 84-3009/69  
Fig.1

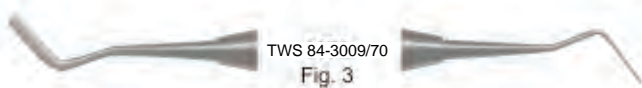

TWS 84-3009/70  
Fig. 3

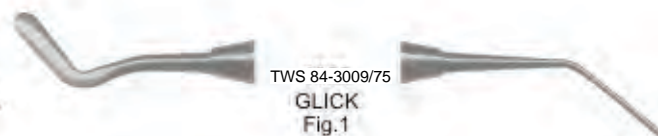

TWS 84-3009/75  
GLICK  
Fig.1

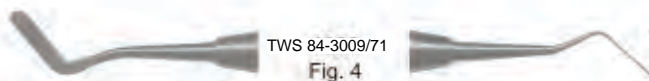

TWS 84-3009/71  
Fig. 4

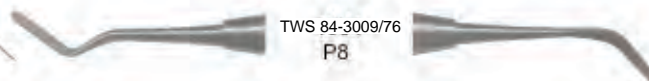

TWS 84-3009/76  
P8

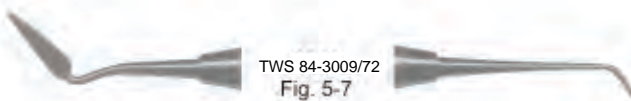

TWS 84-3009/72  
Fig. 5-7

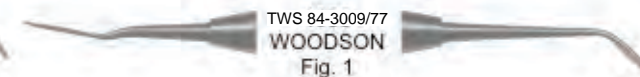

TWS 84-3009/77  
WOODSON  
Fig. 1

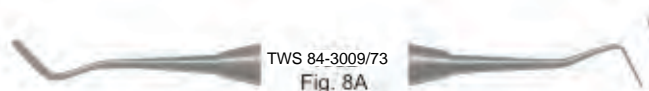

TWS 84-3009/73  
Fig. 8A

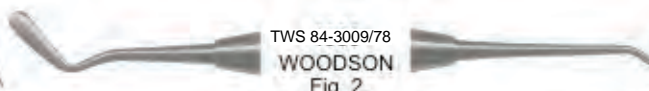

TWS 84-3009/78  
WOODSON  
Fig. 2

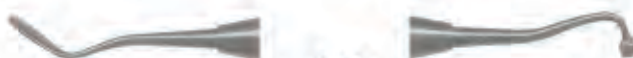

TWS 84-3009/74  
WOODSON  
Fig. 3

Treasure Wright (U.K.) Ltd.

128-160 City Road, London, EC1V 2NX, United Kingdom  
info@twrightmedical.com



TW Surgical

# Curettes



TWS 84-3009/79  
GRACEY  
GC 1-2



TWS 84-3009/80  
GRACEY  
GC 3-4



TWS 84-3009/81  
GRACEY  
GC 5-6



TWS 84-3009/82  
GRACEY  
GC 7-8



TWS 84-3009/83  
GRACEY  
GC 9-10



TWS 84-3009/84  
GRACEY  
GC 11-12



TWS 84-3009/85  
GRACEY  
GC 13-14

Treasure Wright (U.K.) Ltd.

128-160 City Road, London, EC1V 2NX, United Kingdom  
info@twrightmedical.com



TW Surgical

## Gracey Curettes



TWS 84-3009/86  
G1-2



TWS 84-3009/87  
G3-4



TWS 84-3009/88  
G5-6



TWS 84-3009/89  
G7-8



TWS 84-3009/90  
G9-10



TWS 84-3009/92  
G11-12



TWS 84-3009/93  
G13-14

Treasure Wright (U.K.) Ltd.

128-160 City Road, London, EC1V 2NX, United Kingdom  
info@twrightmedical.com



TW Surgical

## Curettes # 4 Handle

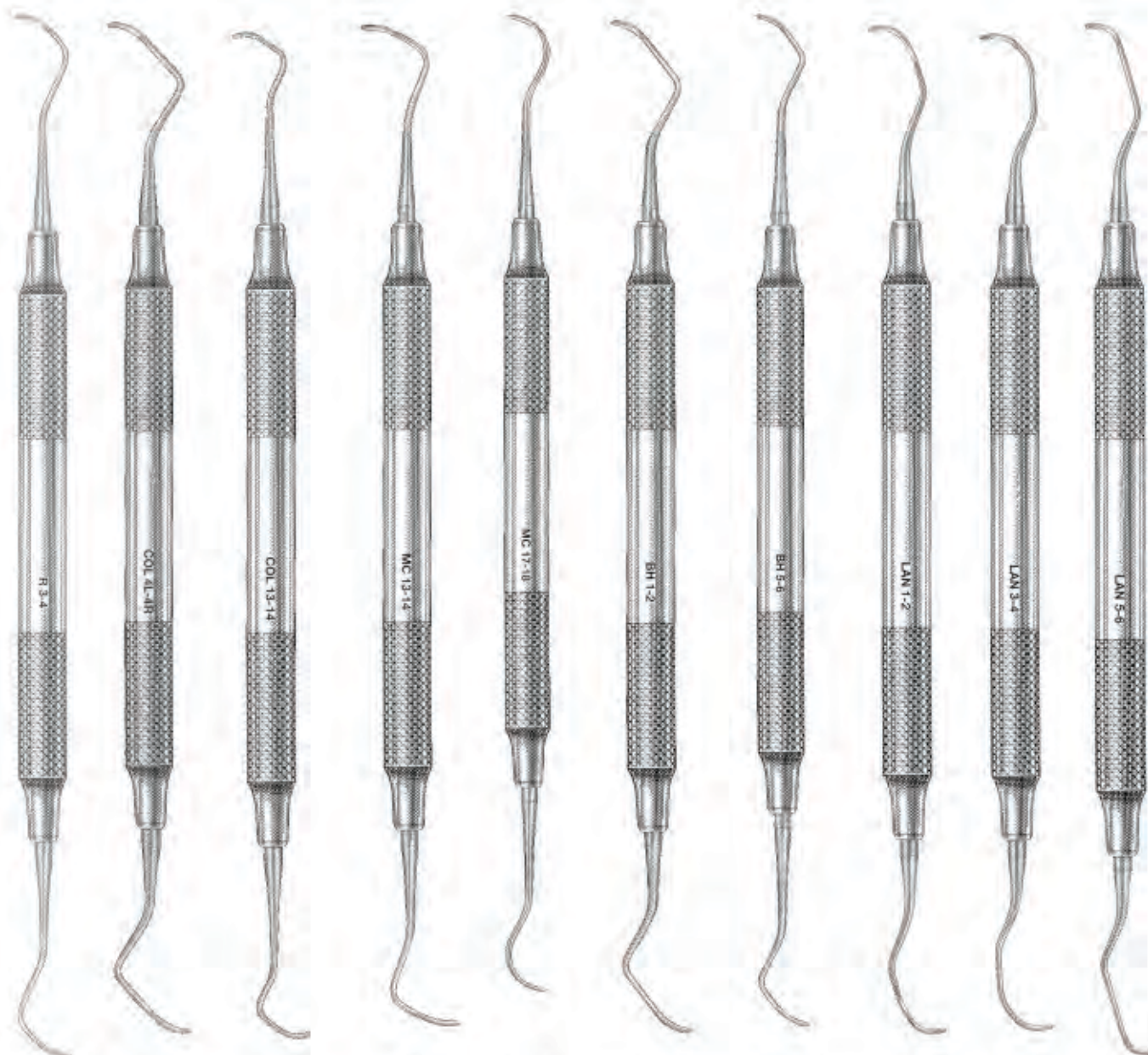

TWS 84-3009/94	TWS 84-3009/95	TWS 84-3009/96	TWS 84-3009/97	TWS 84-3009/98	TWS 84-3009/99	TWS 84-3010/00	TWS 84-3010/01	TWS 84-3010/02	TWS 84-3010/03
RULE	COLUMBIA	COLUMBIA	MCCALLS	MCCALLS	BARNHART	BARNHART	LANGER	LANGER	LANGER
3-4	4R-4L	13-14	13-14	17-18	1-2	5-6	1-2	3-4	5-6

Treasure Wright (U.K.) Ltd.

128-160 City Road, London, ECLV 2NX, United Kingdom  
info@twrightmedical.com



TW Surgical

# Curettes

## COLUMBIA CURETTES



TWS 84-3010/04  
4L-4R

TWS 84-3010/05  
13-14

TWS 84-3010/06  
2L-2R

## MCCALLS CURETTES



TWS 84-3010/07  
13-14

TWS 84-3010/08  
13S-14S

TWS 84-3010/09  
17-18

TWS 84-3010/10  
17S-18S

Treasure Wright (U.K.) Ltd.

128-160 City Road, London, EC1V 2NX, United Kingdom  
info@twrightmedical.com



TW Surgical

# Curettes

## GOLDMAN FOX



TWS 84-3010/11  
GF1 Universal Scaler



TWS 84-3010/12  
GF2 Curette



TWS 84-3010/13  
GF3 Curette



TWS 84-3010/14  
GF4 Curette



TWS 84-3010/15  
GF5 Hoe



TWS 84-3010/16  
GF6 Hoe

Treasure Wright (U.K.) Ltd.

128-160 City Road, London, EC1V 2NX, United Kingdom  
info@twrightmedical.com



TW Surgical

## Curettes

### GOLDMAN FOX



TWS 84-3010/17  
GF 7 Knife



TWS 84-3010/18  
GF 8 Spear Knife



TWS 84-3010/19  
GF 9 Knife Scaler



TWS 84-3010/20  
GF 11 Spear Knife



TWS 84-3010/21  
GF 21 Sharp Spoon /  
Small Scaler

**Treasure Wright (U.K.) Ltd.**

128-160 City Road, London, EC1V 2NX, United Kingdom  
info@twrightmedical.com



TW Surgical

## Knives, Interproximal Files



## Interproximal Files

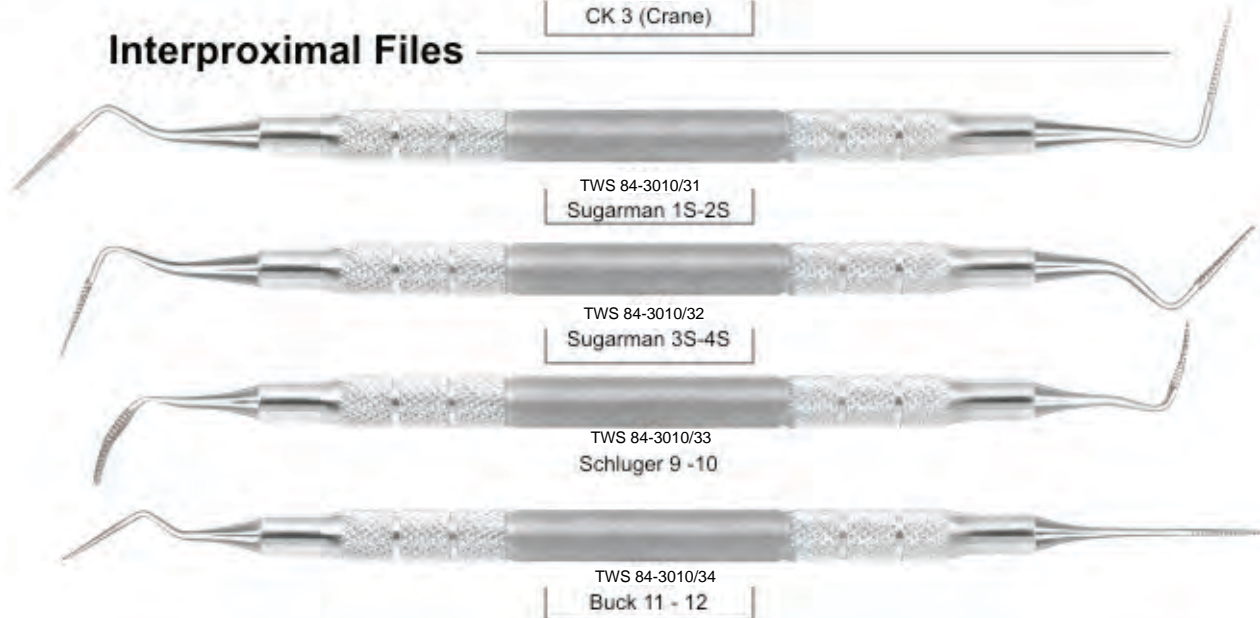

Treasure Wright (U.K.) Ltd.

128-160 City Road, London, EC1V 2NX, United Kingdom  
info@twrightmedical.com



TW Surgical

## Curettes, Root Planning Curettes



TWS 84-3010/35  
COLUMBIA (2L-2R)



TWS 84-3010/36  
MCCALL (13-14)



TWS 84-3010/37  
MCCALL (17S-18S)

### Root Planning Curettes



TWS 84-3010/38  
Root Plane (1-2)



TWS 84-3010/39  
Root Plane (5-6)



TWS 84-3010/43  
Root Plane (11-12)



TWS 84-3010/40  
Root Plane (7-8)



TWS 84-3010/44  
Root Plane (13-14)



TWS 84-3010/41  
Petite (1-2)



TWS 84-3010/45  
Petite (11-12)



TWS 84-3010/42  
Petite (5-6)



TWS 84-3010/46  
Petite (13-14)

Treasure Wright (U.K.) Ltd.

128-160 City Road, London, EC1V 2NX, United Kingdom  
info@twrightmedical.com



TW Surgical

# Curettes



TWS 84-3010/47  
BARNHART (1-2)

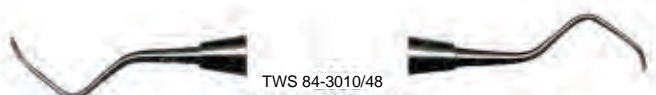

TWS 84-3010/48  
BARNHART (5-6)

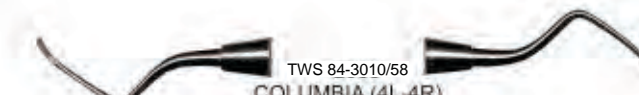

TWS 84-3010/58  
COLUMBIA (4L-4R)

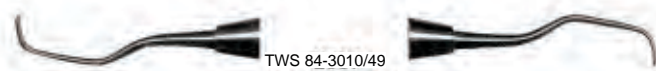

TWS 84-3010/49  
GRACEY (1-2)

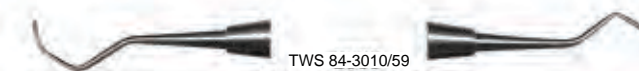

TWS 84-3010/59  
COLUMBIA (13-14)

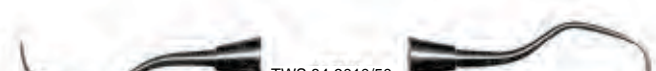

TWS 84-3010/50  
GRACEY (3-4)

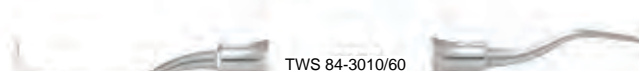

TWS 84-3010/60  
LANGER (1-2)



TWS 84-3010/51  
GRACEY (5-6)



TWS 84-3010/61  
LANGER (3-4)

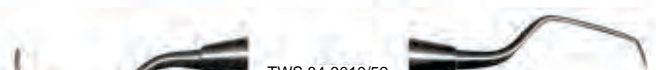

TWS 84-3010/52  
GRACEY (7-8)

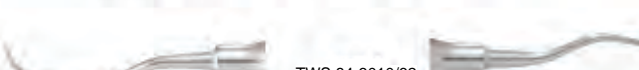

TWS 84-3010/62  
LANGER (5-6)

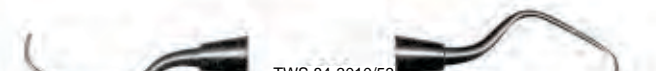

TWS 84-3010/53  
GRACEY (9-10)

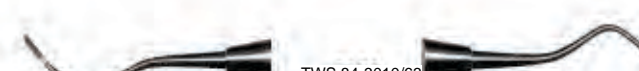

TWS 84-3010/63  
MCCALL (13-14)



TWS 84-3010/54  
GRACEY (11-12)



TWS 84-3010/64  
MCCALL (13S-14S)

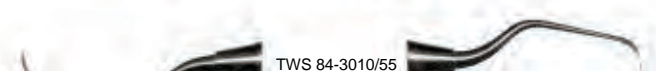

TWS 84-3010/55  
GRACEY (13-14)



TWS 84-3010/65  
MCCALL (17-18)



TWS 84-3010/56  
GRACEY (2L-2R)



TWS 84-3010/66  
MCCALL (17S-18S)



TWS 84-3010/57  
RULE (3-4)

Treasure Wright (U.K.) Ltd.

128-160 City Road, London, EC1V 2NX, United Kingdom  
info@twrightmedical.com



TW Surgical

## Dental Products

Silicon Handles-Reusable



TWS 84-3010/67 TWS 84-3010/68 TWS 84-3010/69 TWS 84-3010/70 TWS 84-3010/71 TWS 84-3010/72 TWS 84-3010/73 TWS 84-3010/74 TWS 84-3010/75 TWS 84-3010/76 TWS 84-3010/77



TWS 84-3010/78



TWS 84-3010/79



TWS 84-3010/80



TWS 84-3010/81



TWS 84-3010/82

Treasure Wright (U.K.) Ltd.

128-160 City Road, London, EC1V 2NX, United Kingdom  
info@twrightmedical.com



TW Surgical

## Wax, Porcelain & Cement Instruments

### Comfort Grip Vinyl - Covered Insulating Handles



TWS 84-3010/83 TWS 84-3010/84 TWS 84-3010/85 TWS 84-3010/86 TWS 84-3010/87 TWS 84-3010/88 TWS 84-3010/9 TWS 84-3010/90 TWS 84-3010/91 TWS 84-3010/92  
ROACH-A ROACH-B LECRON 5-A LECRON 5-B VEHE-A VEHE-B A7 B7 WARD 2-A WARD 2-B

Treasure Wright (U.K.) Ltd.

128-160 City Road, London, EC1V 2NX, United Kingdom  
info@twrightmedical.com



TW Surgical

# Wax, Porcelain & Cement Instruments

## P.K. THOMAS

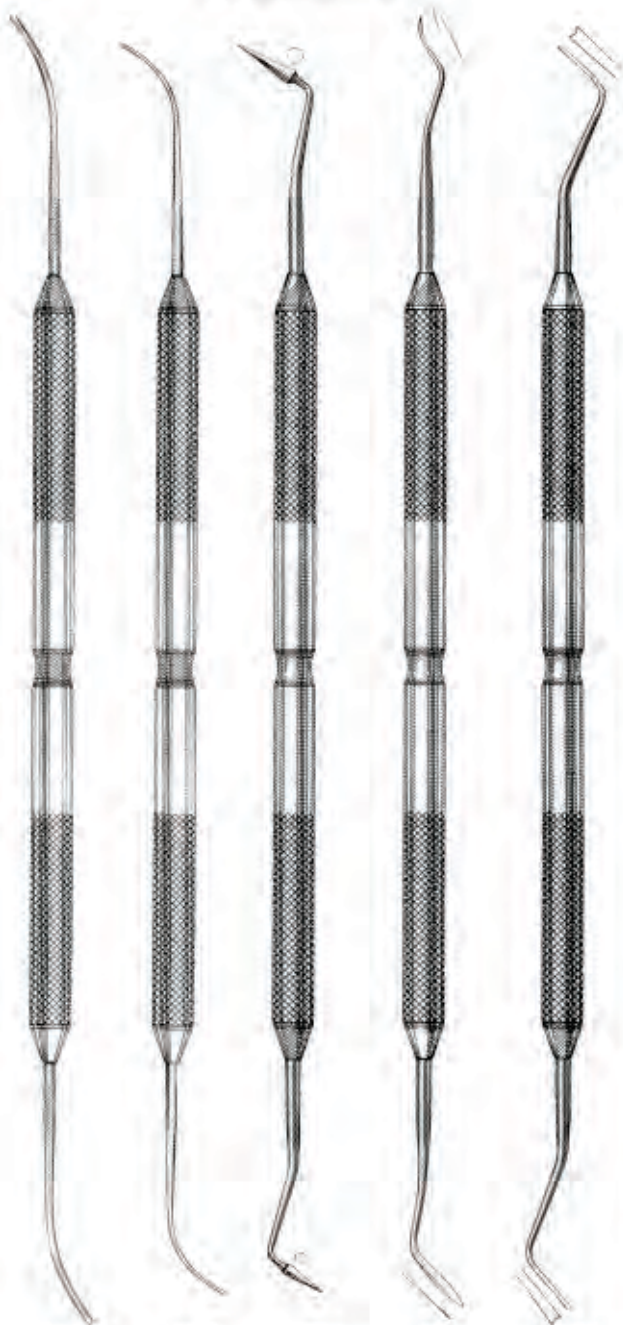

TWS 84-3010/93 PKT 1    TWS 84-3010/94 PKT 2    TWS 84-3010/95 PKT 3    TWS 84-3010/96 PKT 4    TWS 84-3010/97 PKT 5

Set of 5 instruments

## WAX CARVERS

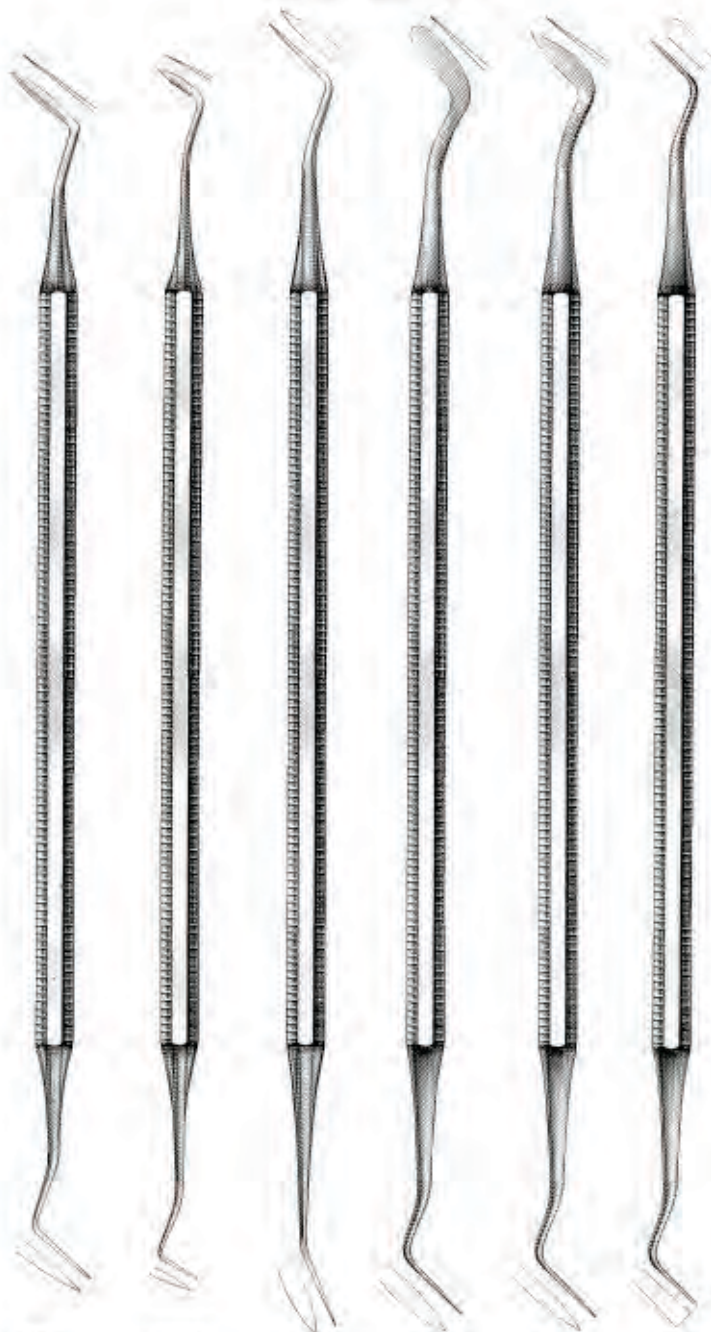

TWS 84-3010/98 Hollenback 3    TWS 84-3010/99 Hollenback 3S    TWS 84-3011/00 WARD 1    TWS 84-3011/01 WARD 2    TWS 84-3011/02 WALL 1    TWS 84-3011/03 WALL 3

Treasure Wright (U.K.) Ltd.

128-160 City Road, London, EC1V 2NX, United Kingdom  
info@twrightmedical.com



TW Surgical

# Wax & Modeling Carvers, Cement Spatulas



Le Cron Le Cron Le Cron MSY MSY Le Cron Hylin Hylin Hylin Zahle Zahle Zahle

TWS 84-3011/04 TWS 84-3011/05 TWS 84-3011/06 TWS 84-3011/07 TWS 84-3011/08 TWS 84-3011/09 TWS 84-3011/10 TWS 84-3011/11 TWS 84-3011/12 TWS 84-3011/13 TWS 84-3011/14 TWS 84-3011/15



Gritman Beale Roach Vehe Fig.0 Fig.1 Fig.2 Fig.3 Fig.4 Weston Fig.3 Fig.1

TWS 84-3011/16 TWS 84-3011/17 TWS 84-3011/18 TWS 84-3011/19 TWS 84-3011/20 TWS 84-3011/21 TWS 84-3011/22 TWS 84-3011/23 TWS 84-3011/24 TWS 84-3011/25 TWS 84-3011/26

Treasure Wright (U.K.) Ltd.

128-160 City Road, London, EC1V 2NX, United Kingdom  
info@twrightmedical.com



TW Surgical

## Wax, Porcelain & Cement Instruments

### WAX & PORCELAIN CARVERS



TWS 84-3011/28  
LECRON  
Inlay

TWS 84-3011/29  
REEVES

TWS 84-3011/30  
VEHE  
Wax

TWS 84-3011/31  
ROACH  
Wax

### WAX SPATULAS



TWS 84-3011/32  
W-31

TWS 84-3011/33  
W-5

TWS 84-3011/34  
W-7

TWS 84-3011/35  
W-7A

TWS 84-3011/36  
W-7G

Treasure Wright (U.K.) Ltd.

128-160 City Road, London, EC1V 2NX, United Kingdom  
info@twrightmedical.com



TW Surgical

# Cement Spatulas



TWS 84-3011/37  
AGATHE



TWS 84-3011/38  
C-7



TWS 84-3011/  
39 C-5



TWS 84-3011/40  
C-313



TWS 84-3011/415  
C-24A Rigid



TWS 84-3011/42  
C-24 Flexible



TWS 84-3011/43  
C-24 Flexible



TWS 84-3011/44  
24



TWS 84-3011/45  
A6



TWS 84-3011/48  
7 Wax



TWS 84-3011/46  
26



TWS 84-3011/49

All Metal Spatulas with High Polish  
Stainless Steel Blade



TWS 84-3011/47  
31

Treasure Wright (U.K.) Ltd.

128-160 City Road, London, EC1V 2NX, United Kingdom  
info@twrightmedical.com



TW Surgical

# Spatulas



TWS 84-3011/50  
Fig. 1  
18.5 cm

TWS 84-3011/51  
Fig. 2  
18 cm

TWS 84-3011/52  
Fig. 3  
18.5 cm

TWS 84-3011/53  
Fig. 4  
19.5 cm

TWS 84-3011/54  
Fig. 5  
21.5 cm

TWS 84-3011/55  
Fig. 6  
20.5 cm

Treasure Wright (U.K.) Ltd.

128-160 City Road, London, EC1V 2NX, United Kingdom  
info@twrightmedical.com



TW Surgical

# Spatulas



Treasure Wright (U.K.) Ltd.

128-160 City Road, London, EC1V 2NX, United Kingdom  
info@twrightmedical.com



TW Surgical

# Files, Hoes & Knives

## FILES

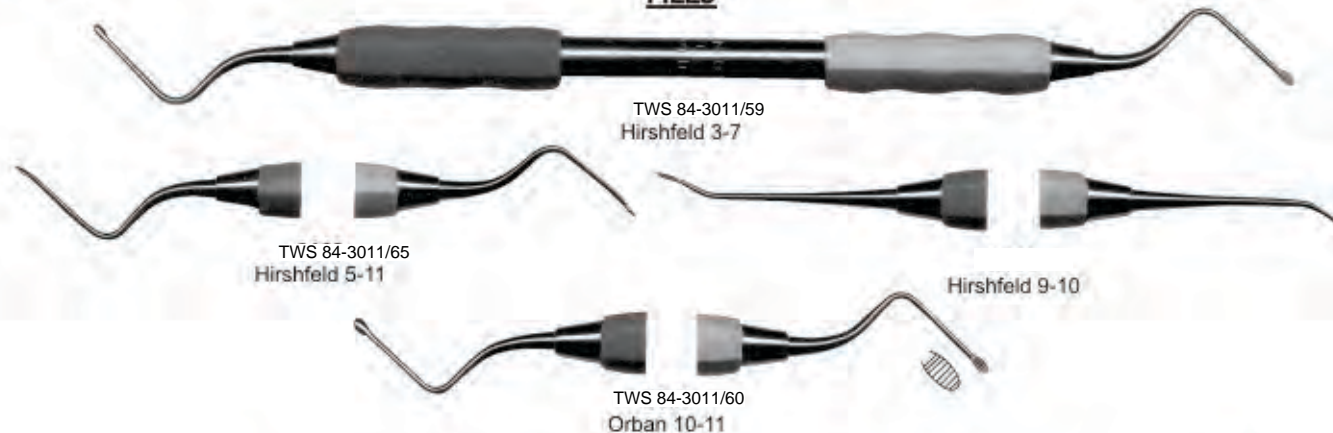

## HOES

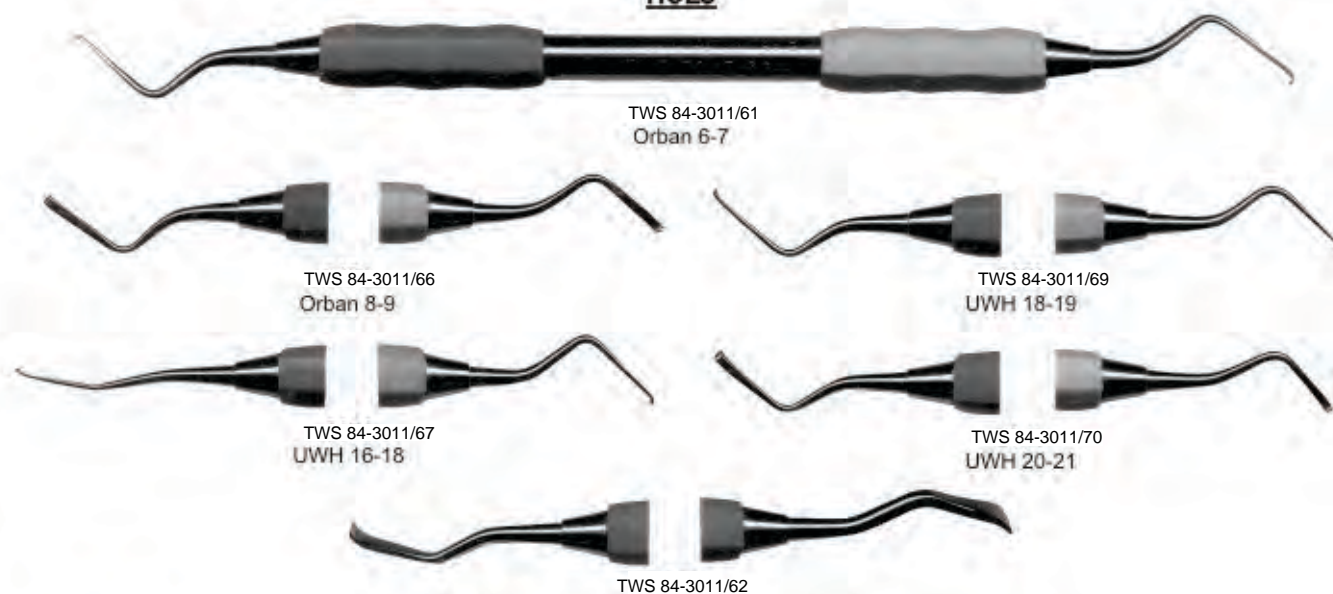

## KNIVES

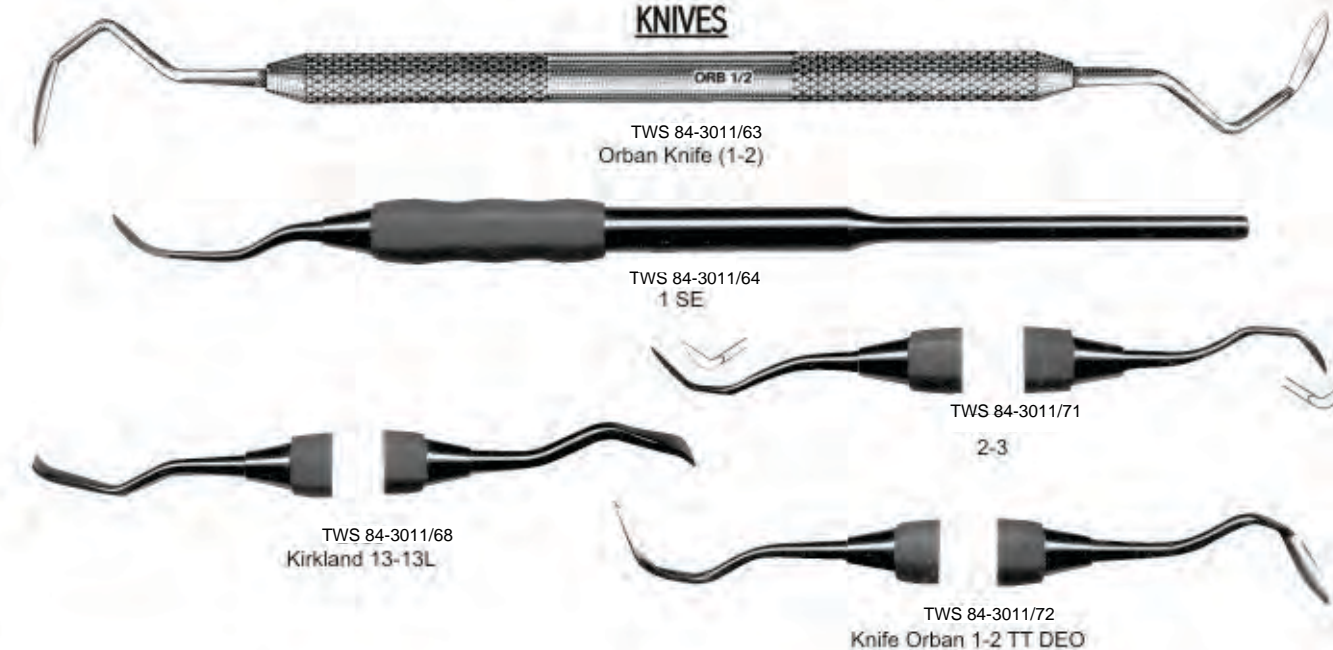

Treasure Wright (U.K.) Ltd.

128-160 City Road, London, EC1V 2NX, United Kingdom  
info@twrightmedical.com



TW Surgical

## Wax Knives



TWS 84-3011/73  
Fahnenstock  
Fig. 1  
12,5cm

TWS 84-3011/74  
Fahnenstock  
Fig. 2  
17cm

TWS 84-3011/75  
Lessmann  
Fig. 1  
12,5cm

TWS 84-3011/76  
Lessmann  
Fig. 2  
17cm

TWS 84-3011/77  
Con scodellino  
Fig. 1  
12,5cm

TWS 84-3011/78  
Con scodellino  
Fig. 2  
17cm

Ermert  
TWS 84-3011/781

Ermert  
TWS 84-3011/782



TW Surgical

## Wax Knives & Plaster Knives



TWS 84-3011/79  
18 cm  
7 1/8"



TWS 84-3011/80  
18 cm  
7 1/8"



TWS 84-3011/81  
17 cm  
6 3/4"  
Gritman



TWS 84-3011/82  
17 cm  
6 3/4"  
Medicon



TWS 84-3011/83  
Fig. 1  
17 cm



TWS 84-3011/84  
22 cm  
8 3/4"



TWS 84-3011/85  
22 cm  
8 3/4"



TWS 84-3011/86  
Gritman  
Fig. 2  
17 cm



TWS 84-3011/87  
Fig. 3  
16 cm



TWS 84-3011/88  
Fig. 4  
16 cm

Treasure Wright (U.K.) Ltd.

128-160 City Road, London, EC1V 2NX, United Kingdom  
info@twrightmedical.com



TW Surgical

# Crane-Kaplan, Chisels

## CRANE-KAPLAN



TWS 84-3011/89  
Ck1  
Pocket Marker

TWS 84-3011/90  
Ck2  
Pocket Marker

TWS 84-3011/91  
Knife

TWS 84-3011/92  
Dissector

TWS 84-3011/93  
Scaler

## OCHSENBEIN



TWS 84-3011/94  
Ochsenbein  
Fig. 1

TWS 84-3011/95  
Ochsenbein  
Fig. 2

TWS 84-3011/96  
Ochsenbein  
Fig. 4



Split Chisel Set



TWS 84-3011/97  
Split Chisel  
6 mm Curved



TWS 84-3011/98  
Split Chisel  
6 mm Straight



TWS 84-3011/99  
Split Chisel  
4 mm Curved



TWS 84-3012/00  
Split Chisel  
4 mm Straight

Treasure Wright (U.K.) Ltd.

128-160 City Road, London, ECLV 2NX, United Kingdom  
info@twrightmedical.com



TW Surgical

# Bone Currettes

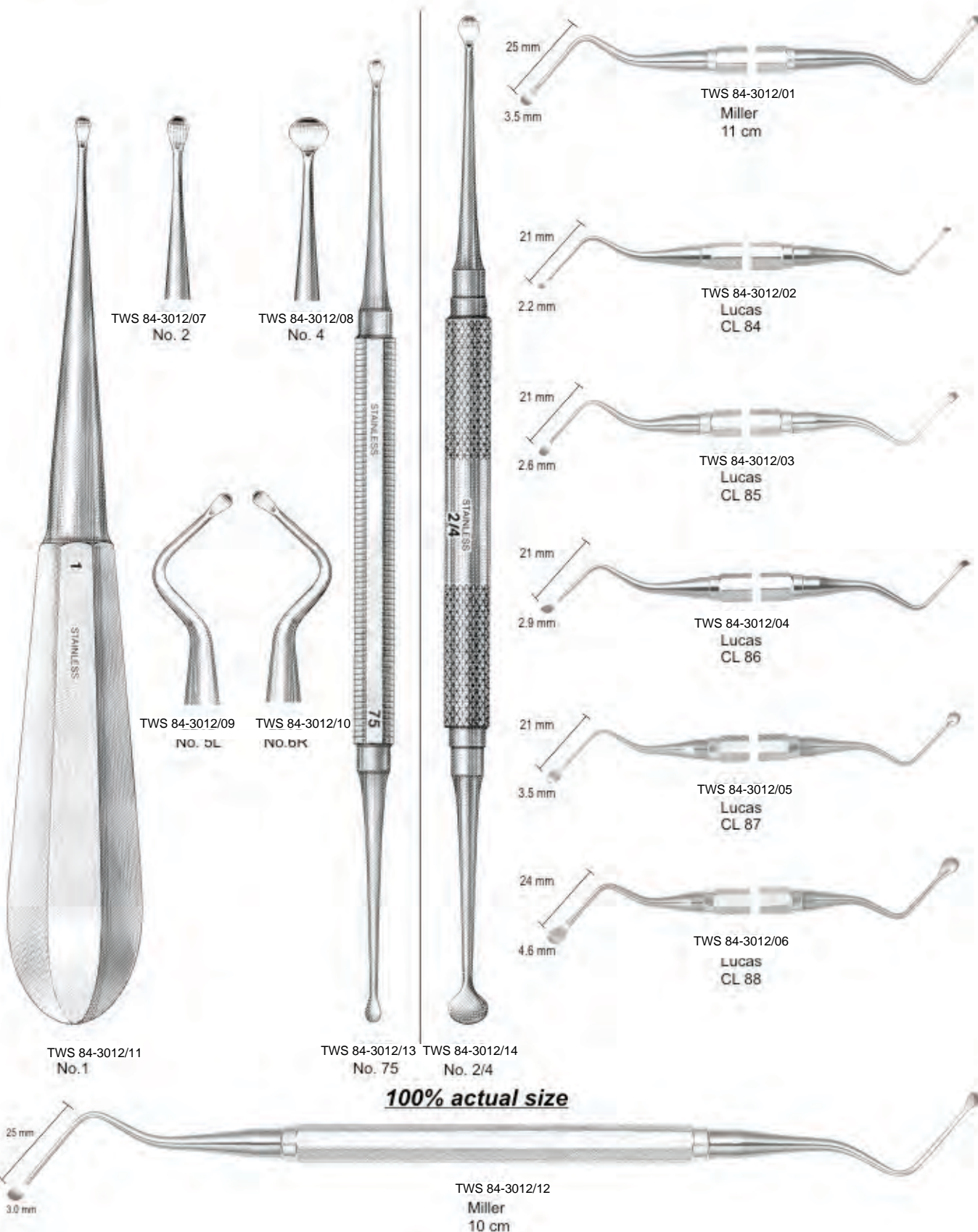

Treasure Wright (U.K.) Ltd.

128-160 City Road, London, EC1V 2NX, United Kingdom  
info@twrightmedical.com



TW Surgical

# Bone Files



TWS 84-3012/15  
No. 10



TWS 84-3012/16  
No. 33



TWS 84-3012/17  
MILLER  
No. 64



TWS 84-3012/18  
MILLER  
No. 64

Treasure Wright (U.K.) Ltd.

128-160 City Road, London, EC1V 2NX, United Kingdom  
info@twrightmedical.com



TW Surgical

## Bone Files

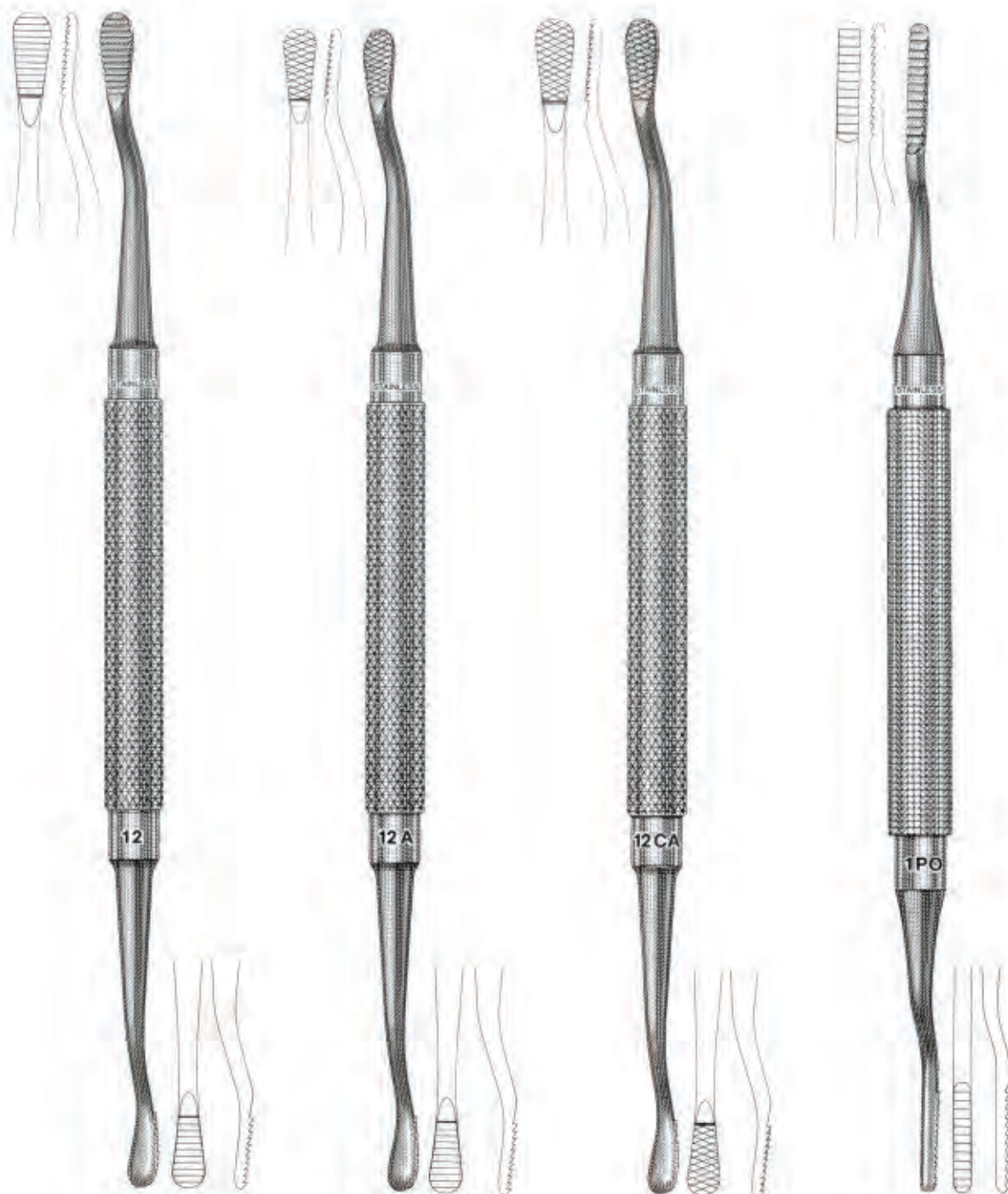

TWS 84-3012/19  
HOWARD  
No. 12

TWS 84-3012/20  
HOWARD  
No. 12A

TWS 84-3012/21  
HOWARD  
No. 12CA

TWS 84-3012/22  
POLOKOFF  
No. 1

Treasure Wright (U.K.) Ltd.

128-160 City Road, London, EC1V 2NX, United Kingdom  
info@twrightmedical.com



TW Surgical

# Bone Chisels

## GARDNER



TWS 84-3012/23  
GARDNER  
No. 1

TWS 84-3012/24  
GARDNER  
No. 2

TWS 84-3012/25  
GARDNER  
No. 5

TWS 84-3012/26  
GARDNER  
No. 5R

## WAKEFIELD



TWS 84-3012/27  
WAKEFIELD  
No. 1W

TWS 84-3012/28  
WAKEFIELD  
No. 2W

Treasure Wright (U.K.) Ltd.

128-160 City Road, London, EC1V 2NX, United Kingdom  
info@twrightmedical.com



TW Surgical

# Bone Chisels, Bone Mallets

## Bone Chisels and Gouges

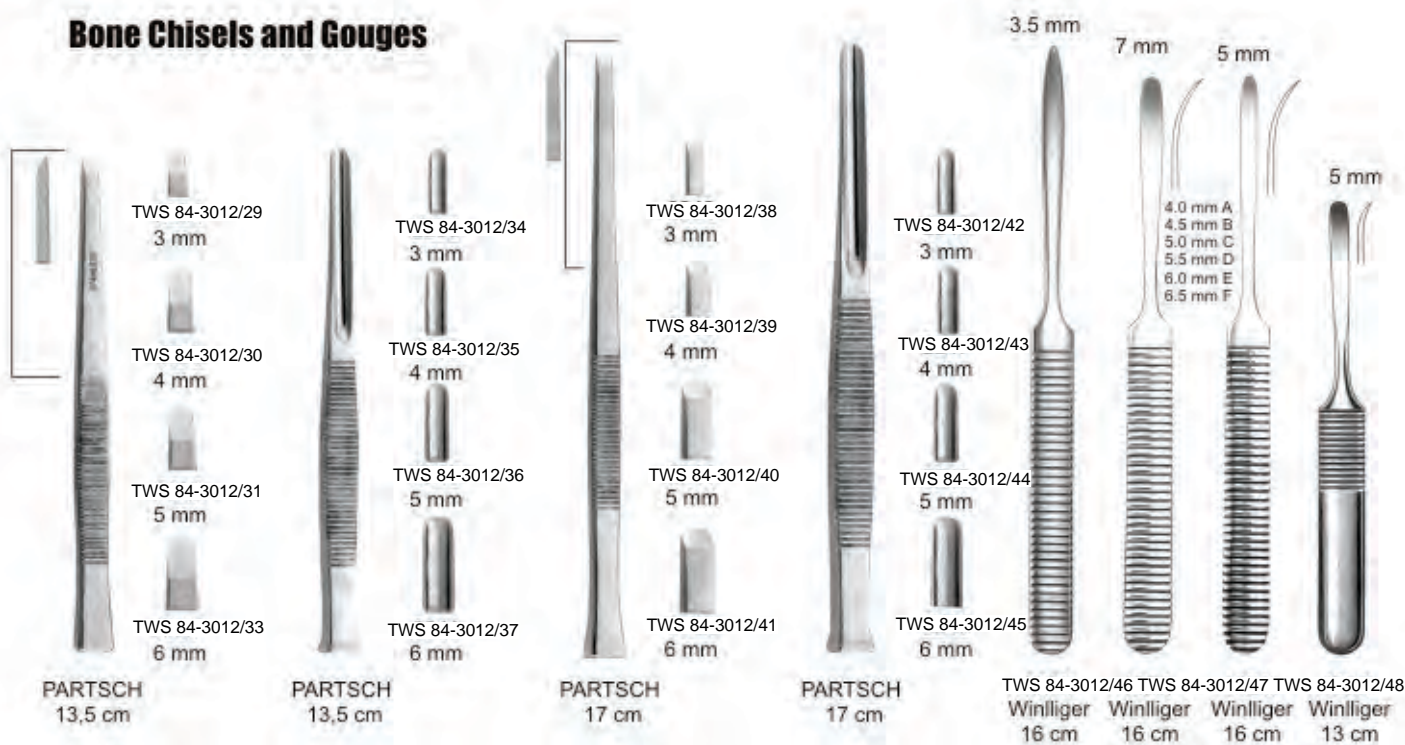

## Martelli chirurgici Mallet



Treasure Wright (U.K.) Ltd.

128-160 City Road, London, EC1V 2NX, United Kingdom  
info@twrightmedical.com



TW Surgical

# Crown Removers

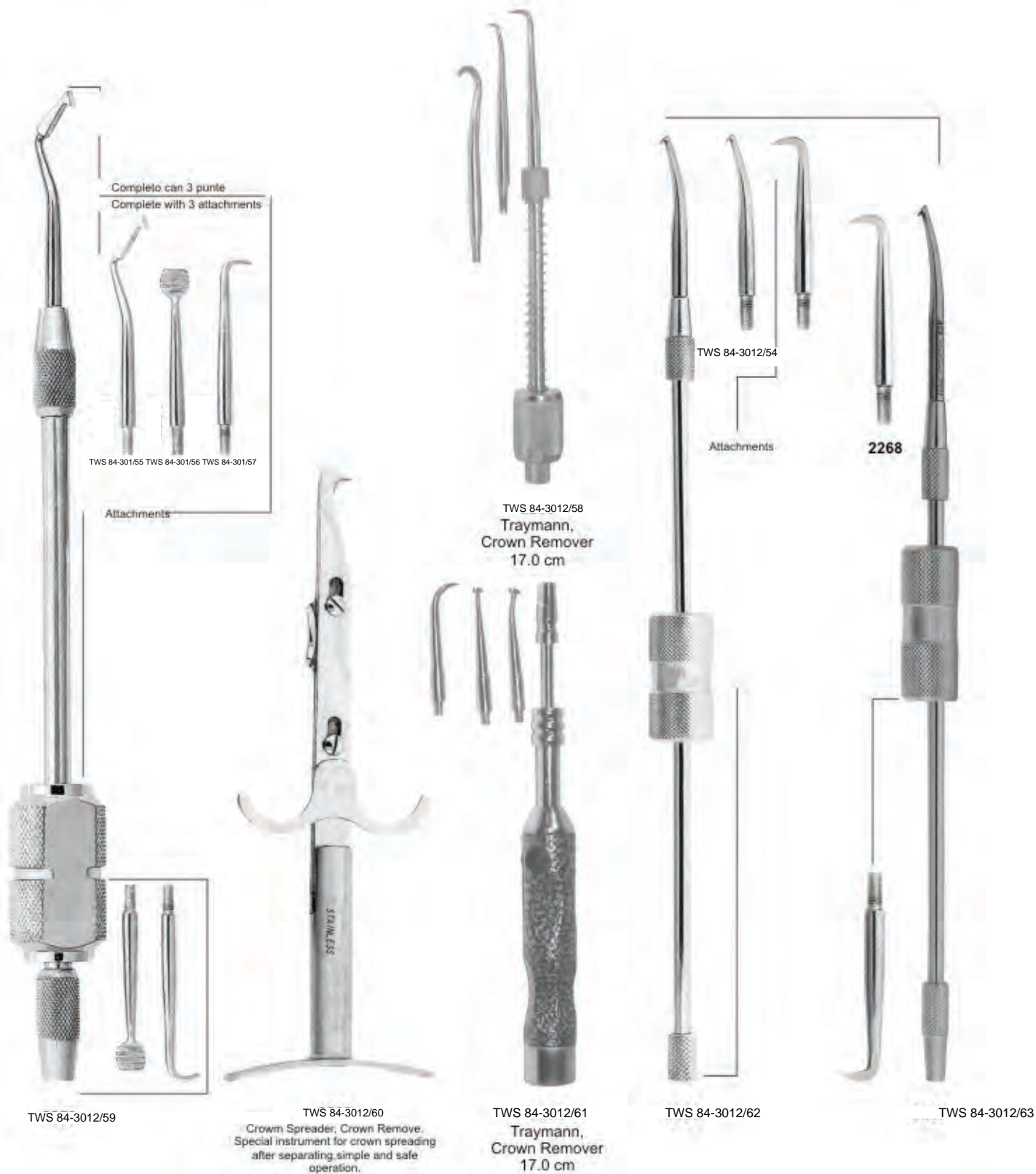

Treasure Wright (U.K.) Ltd.

128-160 City Road, London, EC1V 2NX, United Kingdom  
info@twrightmedical.com



TW Surgical

# Crown Instruments



TWS 84-3012/64  
Crown Remover



TWS 84-3012/65  
Crown Remover



TWS 84-3012/66  
single loop  
with adapter



2272  
2273  
KEY/9 ADAPTER/8  
TWS 84-3012/75 TWS 84-3012/76

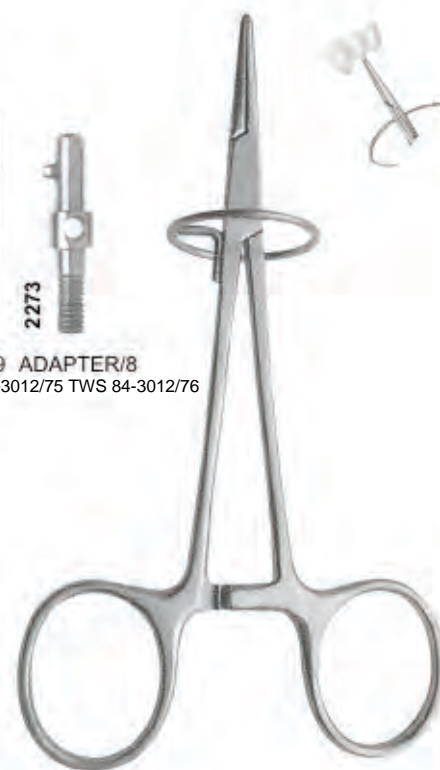

TWS 84-3012/67  
Crown & bridge Holding Forceps  
With Support Ring



TWS 84-3012/72  
WYNNAN  
Crown Gripper, CARB-N-SERT



TWS 84-3012/71  
Crown opener



TWS 84-3012/73  
Merston  
14.5 cm/5 3/4



TWS 84-3012/74  
Universal  
Hollow Handle



TWS 84-3012/68 Fig.2  
TWS 84-3012/69 Fig.3  
TWS 84-3012/70 Fig.4



Treasure Wright (U.K.) Ltd.

128-160 City Road, London, EC1V 2NX, United Kingdom  
info@twrightmedical.com



TW Surgical

## Crown Instruments



TWS 84-3012/77  
Plaster Shear  
210 mm

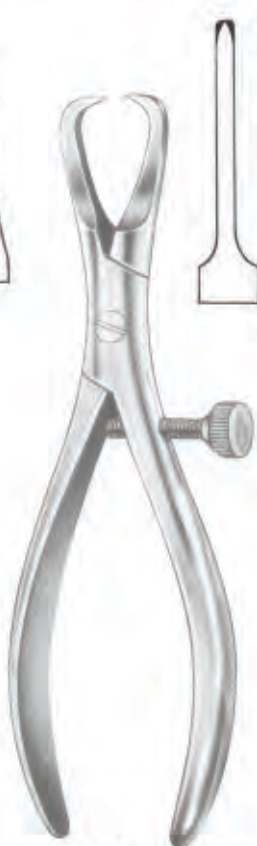

TWS 84-3012/78  
Crown Removing Plier  
14 cm



TWS 84-3012/79  
MONTFORT  
18 CM



TWS 84-3012/80  
BOHM  
16 cm



TWS 84-3012/81  
Telescope Crown  
Plier, Diamond coated  
13.0 cm



TWS 84-3012/82  
Telescope Crown  
Plier, Diamond coated  
13.0 cm



TWS 84-3012/83  
Telescope Crown Plier  
13.0 cm gerieften Maul  
15.0 cm gerieften Maul  
13.0 cm gelatts Maul  
15.0 cm gelatts Maul



TWS 84-3012/84  
Telescope Crown  
Plier, Fine  
15.0 cm



Treasure Wright (U.K.) Ltd.

128-160 City Road, London, EC1V 2NX, United Kingdom  
info@twrightmedical.com



TW Surgical

# Implants Instruments

	$\varnothing$ 2 mm	$\varnothing$ 2 mm	$\varnothing$ 2.7 mm	$\varnothing$ 3.25 mm	$\varnothing$ 3.8 mm
	TWS 84-3012/85 150 mm	TWS 84-3012/86 150 mm	TWS 84-3012/87 150 mm	TWS 84-3012/88 150 mm	
	$\varnothing$ 3 mm	$\varnothing$ 4 mm	$\varnothing$ 5 mm		
	TWS 84-3012/90 150 mm	TWS 84-3012/91 150 mm	TWS 84-3012/92 150 mm		
	$\varnothing$ 1.60 mm	$\varnothing$ 1.90 mm	$\varnothing$ 2.80 mm		
	TWS 84-3012/93 155 mm	TWS 84-3012/94 155 mm	TWS 84-3012/95 155 mm		
	TWS 84-3012/97 155 mm	TWS 84-3012/98 155 mm	TWS 84-3012/99 155 mm		

Treasure Wright (U.K.) Ltd.

128-160 City Road, London, EC1V 2NX, United Kingdom  
info@twrightmedical.com



TW Surgical

# Implants Instruments



TWS 84-3013/05  
Fig. 1B  
165 mm

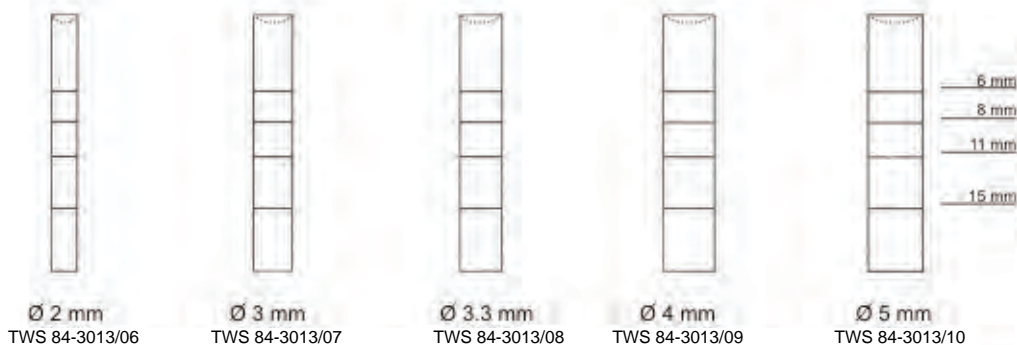
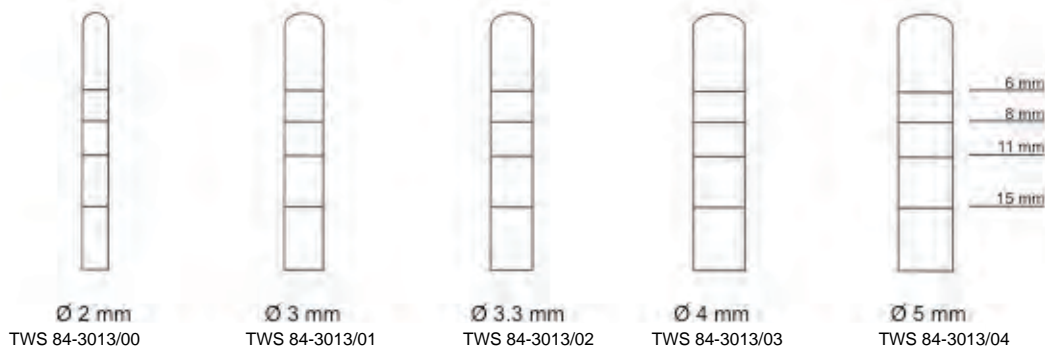

TWS 84-3013/16  
Fig. 1  
155 mm

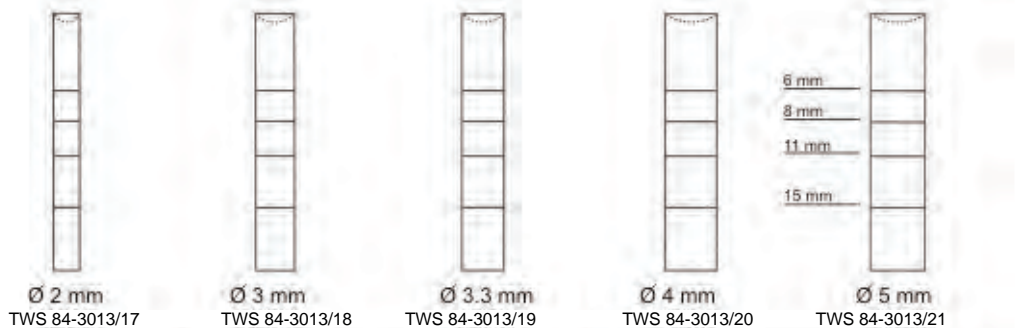
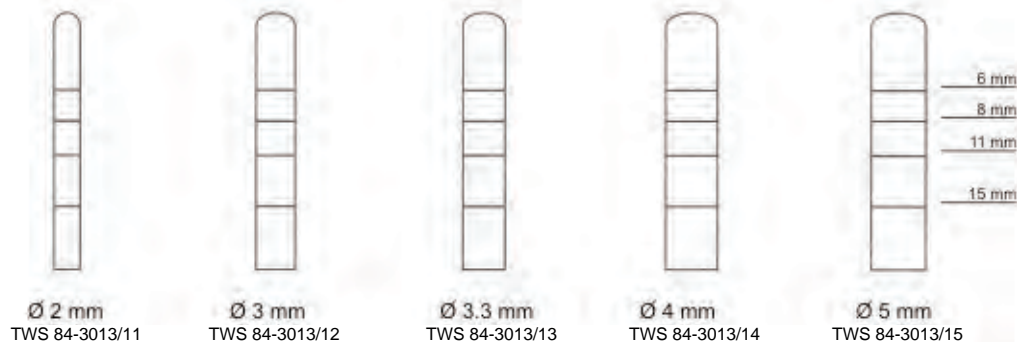

Treasure Wright (U.K.) Ltd.

128-160 City Road, London, EC1V 2NX, United Kingdom  
info@twrightmedical.com

# Implants Instruments

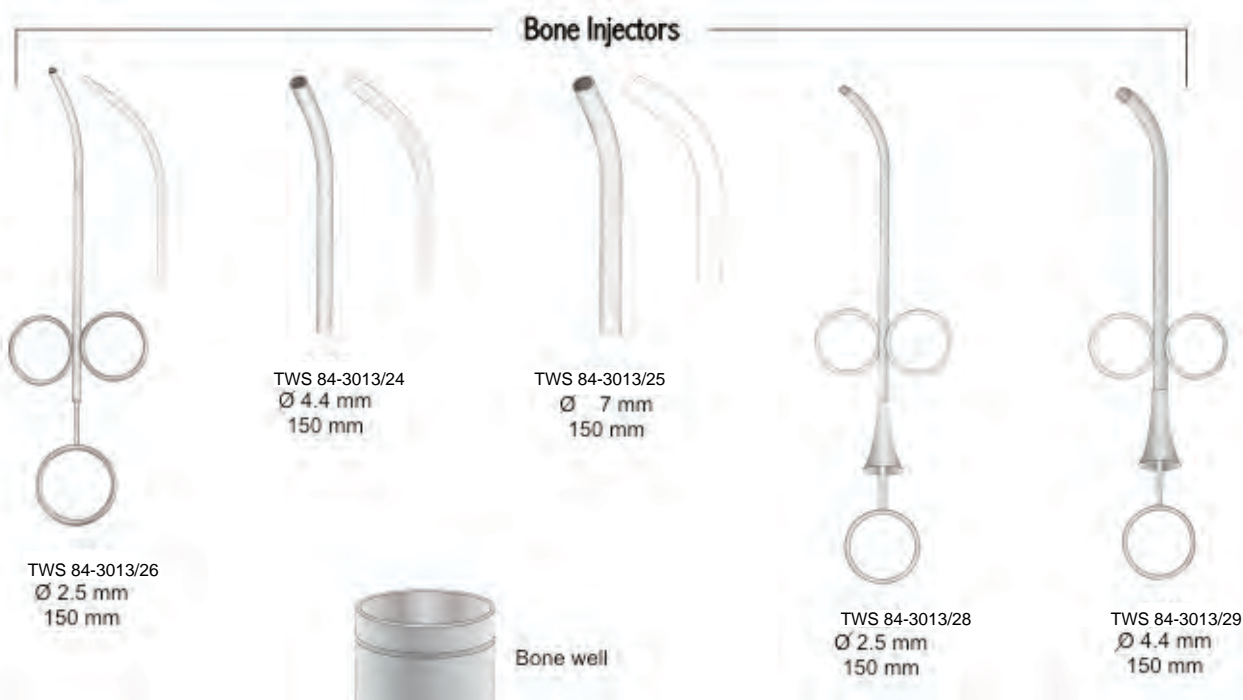
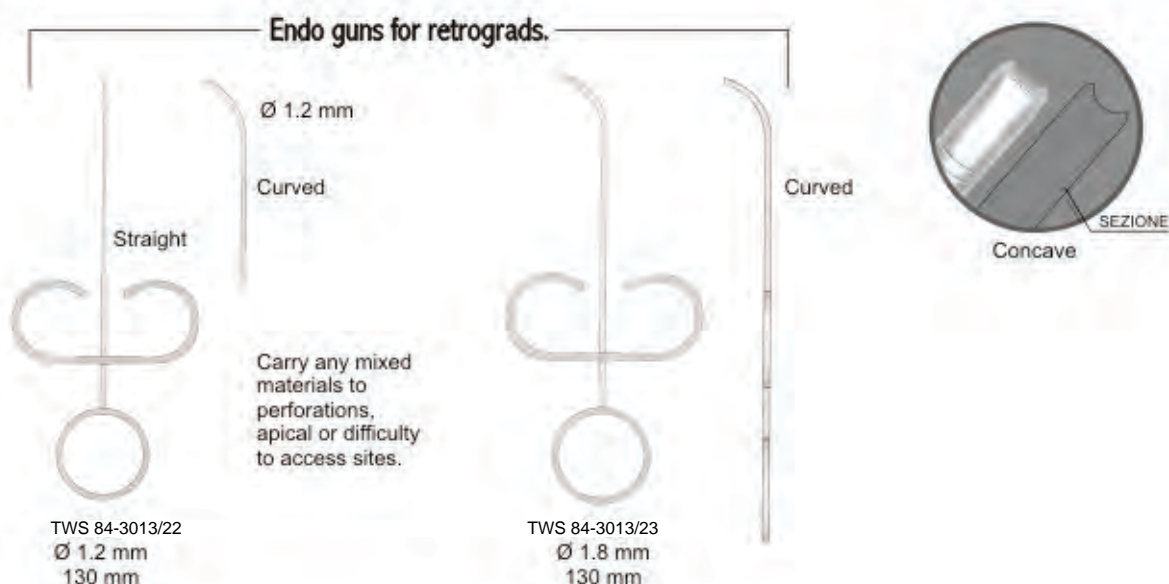

TWS 84-3013/30  
Grinders for autogenous





TW Surgical

# Suction Tubes, Bone Pluggers & Rongeurs

## Suction Tubes



## Bone Pluggers



## Kerrison Rongeurs



( 1.5 mm inside ) TWS 84-3013/39  
 ( 2.0 mm inside ) TWS 84-3013/40  
 ( 3.0 mm inside ) TWS 84-3013/41  
 ( 4.0 mm inside ) TWS 84-3013/42  
 ( 4.5 mm inside ) TWS 84-3013/43

16.5 cm



( 1.0 mm inside ) TWS 84-3013/44  
 ( 2.0 mm inside ) TWS 84-3013/45  
 ( 2.50 mm inside ) TWS 84-3013/46

16.5 cm

Treasure Wright (U.K.) Ltd.

128-160 City Road, London, EC1V 2NX, United Kingdom  
info@twrightmedical.com



TW Surgical

# Implants Instruments



TWS 84-3013/53 Fig. 1 170 mm  
 TWS 84-3013/54 Fig. 2 175 mm  
 TWS 84-3013/55 Fig. 3 170 mm  
 TWS 84-3013/56 LUCAS Fig. 88 170 mm

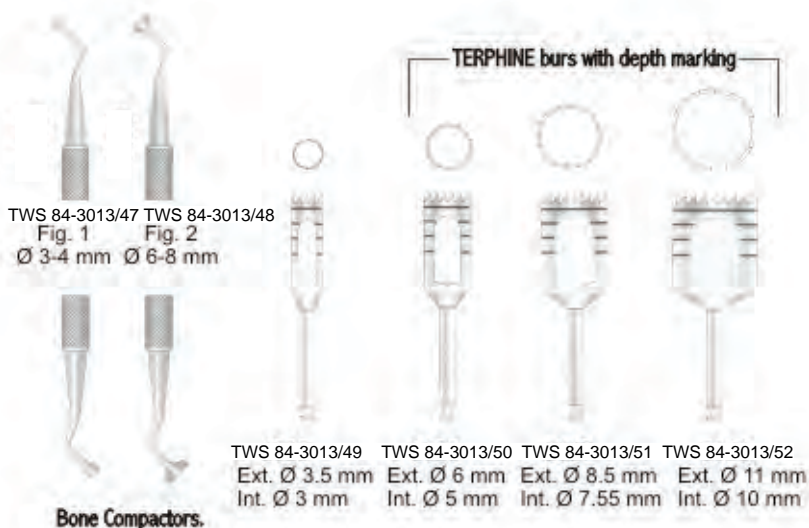

## Sinus lift instruments



TWS 84-3013/57 Fig.1  
 TWS 84-3013/58 Fig.2  
 TWS 84-3013/59 Fig.3  
 TWS 84-3013/60 Fig.4  
 TWS 84-3013/61 Fig.5  
 TWS 84-3013/62 Fig.6  
 TWS 84-3013/63 Fig.7  
 TWS 84-3013/64 Fig.8  
 TWS 84-3013/65 Fig.9

Treasure Wright (U.K.) Ltd.

128-160 City Road, London, EC1V 2NX, United Kingdom  
info@twrightmedical.com



TW Surgical

## Suction Tubes

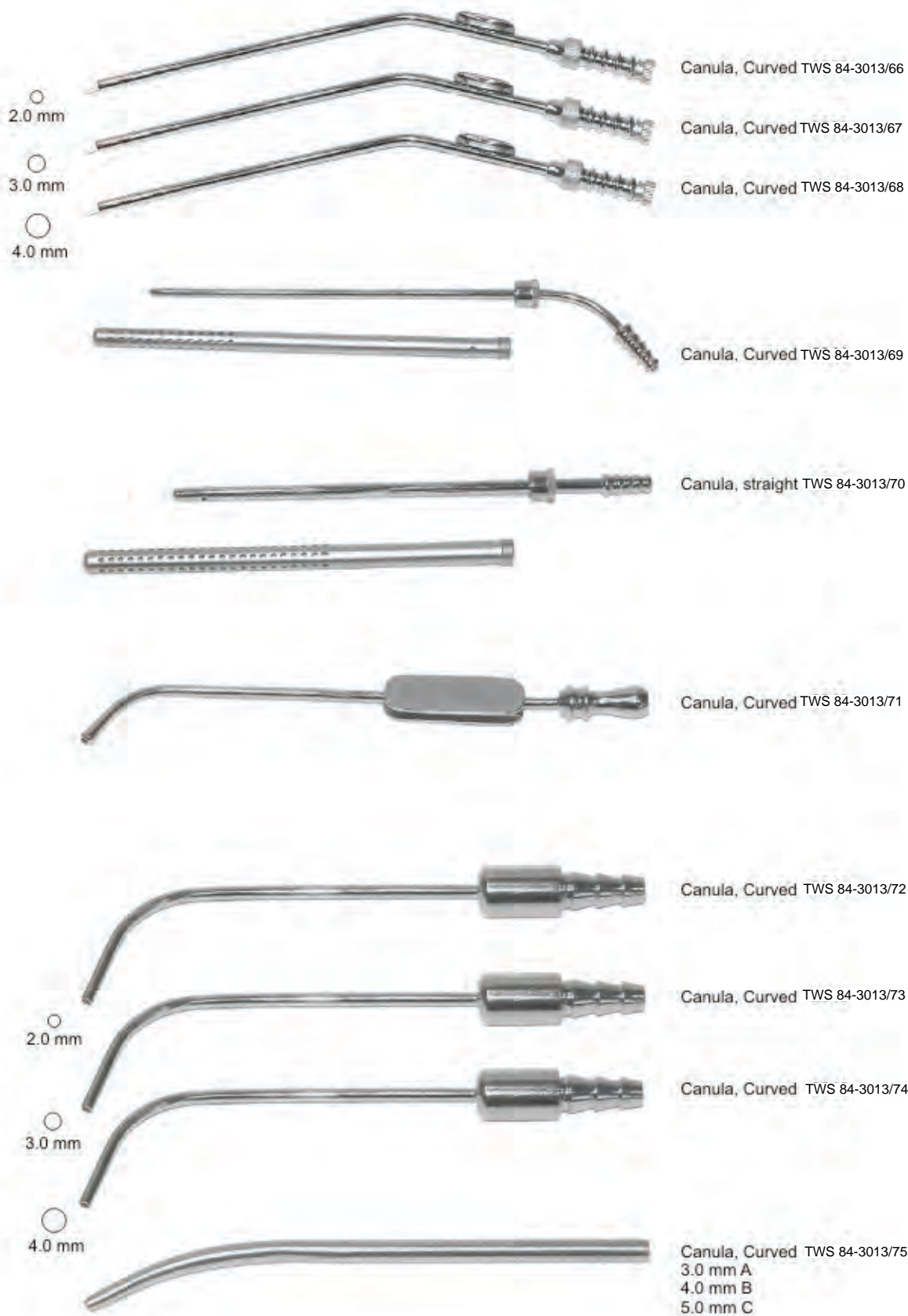

Treasure Wright (U.K.) Ltd.

128-160 City Road, London, EC1V 2NX, United Kingdom  
info@twrightmedical.com



TW Surgical

# Measuring Instruments



TWS 84-3013/76  
BOLEY Gauge



TWS 84-3013/77  
ZURICHER  
130 mm



TWS 84-3013/78  
VERNIER  
12 cm



TWS 84-3013/79  
VERNIER



TWS 84-3013/80  
VERNIER Gauge



TWS 84-3013/81  
VERNIER Gauge



TWS 84-3013/82  
Finger Ruler



TWS 84-3013/83  
LWANSON  
Crown Gauge



TWS 84-3013/84  
LWANSON  
Crown Gauge



TWS 84-3013/85  
Sliding Gauge  
10 cm



TWS 84-3013/86  
Spring Bow Divider  
6" Radius



TWS 84-3013/87  
VERNIER  
Gauge



TWS 84-3013/88  
ALBEE



TWS 84-3013/89  
Height Gauge  
Wick Type

Treasure Wright (U.K.) Ltd.

128-160 City Road, London, EC1V 2NX, United Kingdom  
info@twrightmedical.com



TW Surgical

# Bone Gauge & Measuring Instruments



TWS 84-3013/93  
Bone Gauge



TWS 84-3013/94  
Bone Caliper  
15 cm



TWS 84-3013/92  
Castroviejo



TWS 84-3013/95  
Castroviejo  
Curved

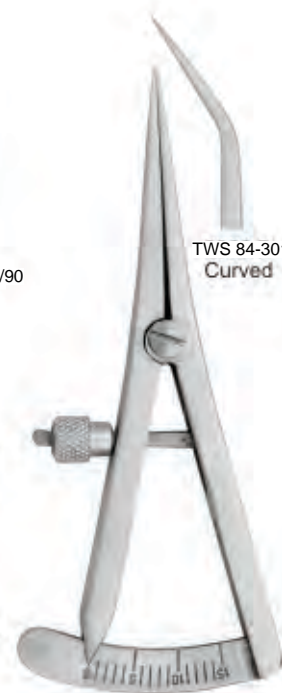

TWS 84-3013/96  
Castroviejo  
Straight

TWS 84-3013/90  
Straight

TWS 84-3013/91  
Curved



TWS 84-3014/04  
Gauge



TWS 84-3014/05  
Castroviejo  
Straight

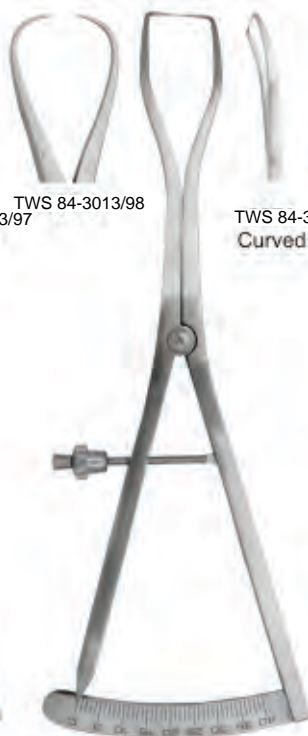

TWS 84-3014/06  
Castroviejo  
Straight

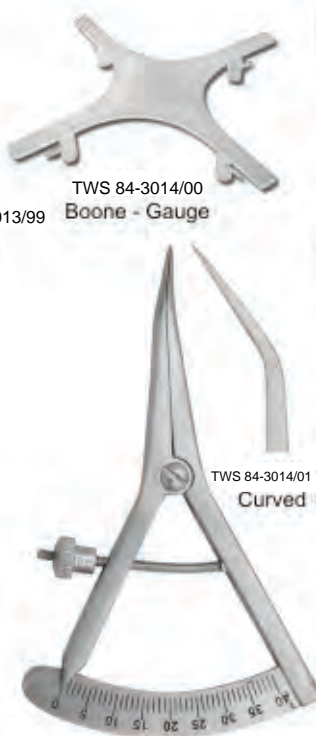

TWS 84-3014/07  
Castroviejo



TWS 84-3014/00  
Boone - Gauge



TWS 84-3013/97  
Curved



TWS 84-3013/98



TWS 84-3013/99  
Curved

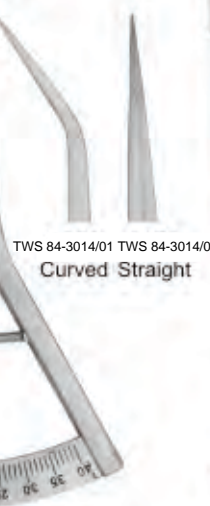

TWS 84-3014/01  
Curved Straight



TWS 84-3014/08  
Bracket Gauge. Ant/Post



Treasure Wright (U.K.) Ltd.

128-160 City Road, London, EC1V 2NX, United Kingdom  
info@twrightmedical.com



TW Surgical

# Amalgam Guns & Carriers



TWS 84-3014/09 Medium-Large 20 cm	TWS 84-3014/10 Medium-Jumbo 20 cm	TWS 84-3014/11 Large-Jumbo 20 cm	TWS 84-3014/12 Jumbo-Jumbo 20 cm	TWS 84-3014/13 Regular-Jumbo Silicon Grip 20 cm	TWS 84-3014/14 Medium 15.5 cm	TWS 84-3014/15 Large 15.5 cm	TWS 84-3014/16 Jumbo 15.5 cm
---	---	--	--	--	-------------------------------------	------------------------------------	------------------------------------



TWS 84-3014/18 145 mm	TWS 84-3014/19 130 mm	Ø 2 mm TWS 84-3014/20 Straight 15 cm	Ø 2 mm TWS 84-3014/21 15 cm	TWS 84-3014/22 15 cm 90°	TWS 84-3014/17 Amalgam Well Non Skid Base Ø 3.5 mm
--------------------------	--------------------------	---	-----------------------------------	--------------------------------	---

Treasure Wright (U.K.) Ltd.

128-160 City Road, London, EC1V 2NX, United Kingdom  
info@twrightmedical.com



TW Surgical

# Retainers, Bands, Strip Holder Clips, Napkin Holder

## Retainers

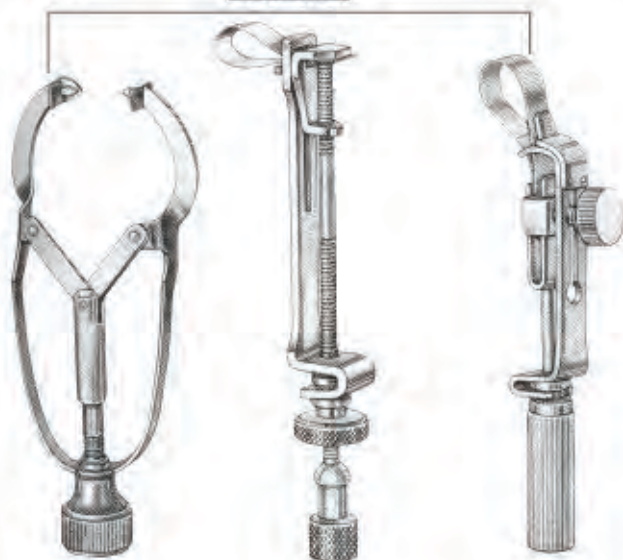

TWS 84-3014/23  
No. 1

TWS 84-3014/24  
No. 8

TWS 84-3014/25  
No. 9

## "Tofflemire" Type Retainers

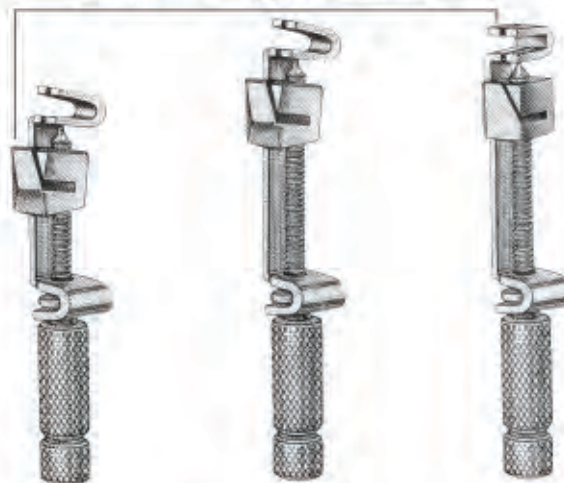

TWS 84-3014/26  
JUNIOR-CA

TWS 84-3014/27  
SENIOR-CA

TWS 84-3014/28  
UNIVERSAL

## Tofflemire Bands

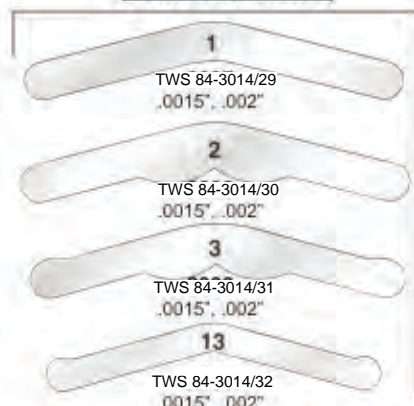

1  
TWS 84-3014/29  
.0015", .002"

2  
TWS 84-3014/30  
.0015", .002"

3  
TWS 84-3014/31  
.0015", .002"

13  
TWS 84-3014/32  
.0015", .002"

TWS 84-3014/33  
X-Ray Holder  
Small



Set of 10  
TWS 84-3014/34  
Film Hanger



## Napkin Holders



TWS 84-3014/35  
BALL CHAIN

TWS 84-3014/36  
NON-CHILL  
Clear Plastic

## Strip Holders

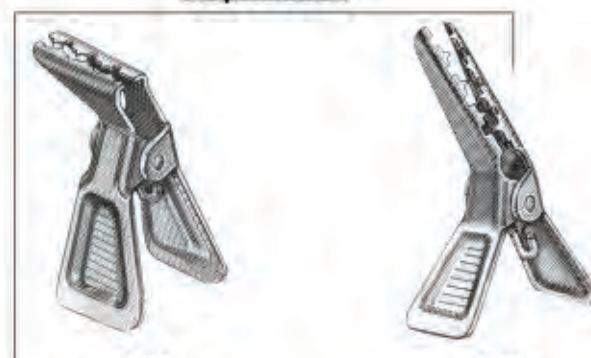

TWS 84-3014/40  
Strip Holder Clip  
90°

TWS 84-3014/41  
Strip Holder Clip  
45°

TWS 84-3014/37  
Finger Protector  
Small



TWS 84-3014/38  
Medium



TWS 84-3014/39  
Large



Treasure Wright (U.K.) Ltd.

128-160 City Road, London, EC1V 2NX, United Kingdom  
info@twrightmedical.com



TW Surgical

## Rubber Dam Instruments



TWS 84-3014/42  
**IRORY**  
Light weight, 170 mm



TWS 84-3014/43  
**BREWER**  
175 mm

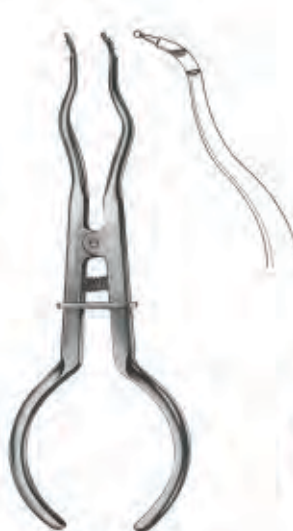

TWS 84-3014/44  
**BREWER**  
175 mm



TWS 84-3014/45  
**WHITE**  
175 mm



TWS 84-3014/46  
**IVORY**  
170 mm



TWS 84-3014/47  
**AINSWORTH**  
Rubber Dam Punch  
170 mm



TWS 84-3014/48  
**AINSWORTH**  
Ainsworth  
Rubber Dam Punch  
170 mm



TWS 84-3014/49  
**AINSWORTH**  
Rubber Dam Punch  
170 mm



TWS 84-3014/50  
**"IV" Type**  
Rubber Dam Punch  
160 mm



TWS 84-3014/51  
**Plastic Rubber Dam**  
Frame 242



TWS 84-3014/52  
**Rubber Dam Holder**  
Stainless Steel Pins

## Articulating Paper Forceps



TWS 84-3014/53  
**MILLER**  
Articulating  
Forceps  
15 cm

TWS 84-3014/54  
**MILLER**  
Articulating  
Forceps  
15 cm

Treasure Wright (U.K.) Ltd.

128-160 City Road, London, EC1V 2NX, United Kingdom  
info@twrightmedical.com



TW Surgical

# Rubber Dam Clamps

## LOWER MOLARS



TWS 84-3014/55  
76D-W3



TWS 84-3014/56  
76D-3



TWS 84-3014/61  
76D-7A



TWS 84-3014/62  
76D-7



TWS 84-3014/67  
76D-12A

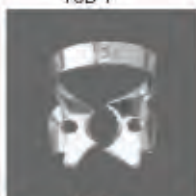

TWS 84-3014/68  
76D-13A



TWS 84-3014/73  
76D-26



TWS 84-3014/74  
76D-28



TWS 84-3014/81  
76D-W8A



TWS 84-3014/82  
76D-8A

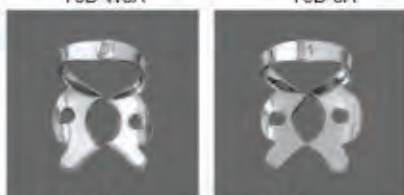

TWS 84-3014/83  
76D-10



TWS 84-3014/84  
76D-11



TWS 84-3014/87  
76D-24



TWS 84-3014/88  
76D-25

## UPPER MOLARS



TWS 84-3014/57  
76D-4



TWS 84-3014/58  
76D-5



TWS 84-3014/63  
76D-8



TWS 84-3014/64  
76D-26N

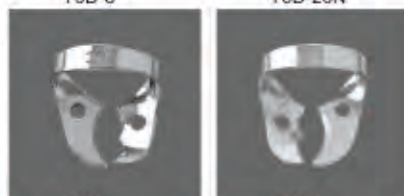

TWS 84-3014/69  
76D-30



TWS 84-3014/70  
76D-31



TWS 84-3014/75  
76D-201



TWS 84-3014/76  
205

## MOLARS



TWS 84-3014/85  
76D-14



TWS 84-3014/86  
76D-118



TWS 84-3014/89  
76D-27



TWS 84-3014/90  
76D-56

## PREMOLARS



TWS 84-3014/59  
76D-0



TWS 84-3014/60  
76D-1

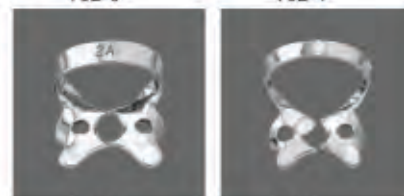

TWS 84-3014/65  
76D-2A



TWS 84-3014/66  
76D-2



TWS 84-3014/71  
76D-27N

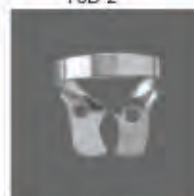

TWS 84-3014/72  
76D-29

## ANTERIOR

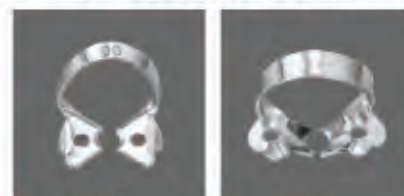

TWS 84-3014/77  
76D-00



TWS 84-3014/78  
76D-1A

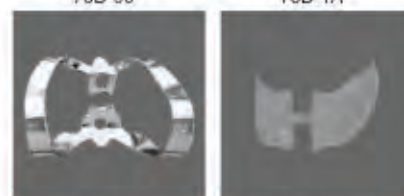

TWS 84-3014/79  
76D-9



TWS 84-3014/80  
76D-212

Treasure Wright (U.K.) Ltd.

128-160 City Road, London, EC1V 2NX, United Kingdom  
info@twrightmedical.com



TW Surgical

# Aspirating Syringes

TWS 84-3014/92



TWS 84-3014/93



TWS 84-3014/94



TWS 84-3014/95  
ml 1,8  
EU

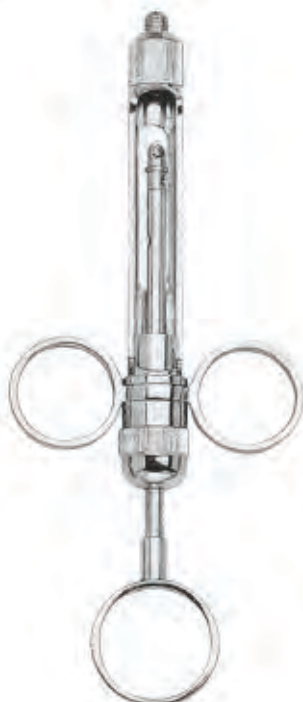

TWS 84-3014/96  
ml 1,8  
EU/AM



TWS 84-3014/97  
ml 1,8  
EU/AM



TWS 84-3014/98  
Fig. 1  
ml 1,8  
EU



TWS 84-3014/99  
Fig. 1  
ml 1,8  
EU



TWS 84-3015/00  
SS INOX  
All inox & autoclavable  
black plastic handle  
passive automatic  
aspiration.



TWS 84-3015/01  
Fig. 1  
ml 1,8  
EU/Am



TWS 84-3015/02  
Fig. 1  
ml 1,8  
EU/Am



TWS 84-3015/03  
Fig. 1  
ml 1,8  
EU/Am

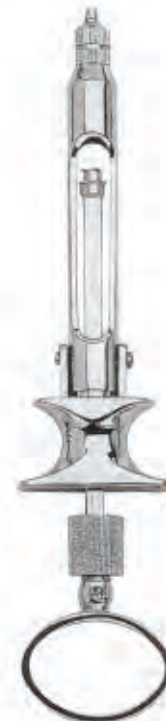

TWS 84-3015/04  
Fig. 1  
ml 1,2  
EU/Am

Treasure Wright (U.K.) Ltd.

128-160 City Road, London, ECLV 2NX, United Kingdom  
info@twrightmedical.com



TW Surgical

# Syringes

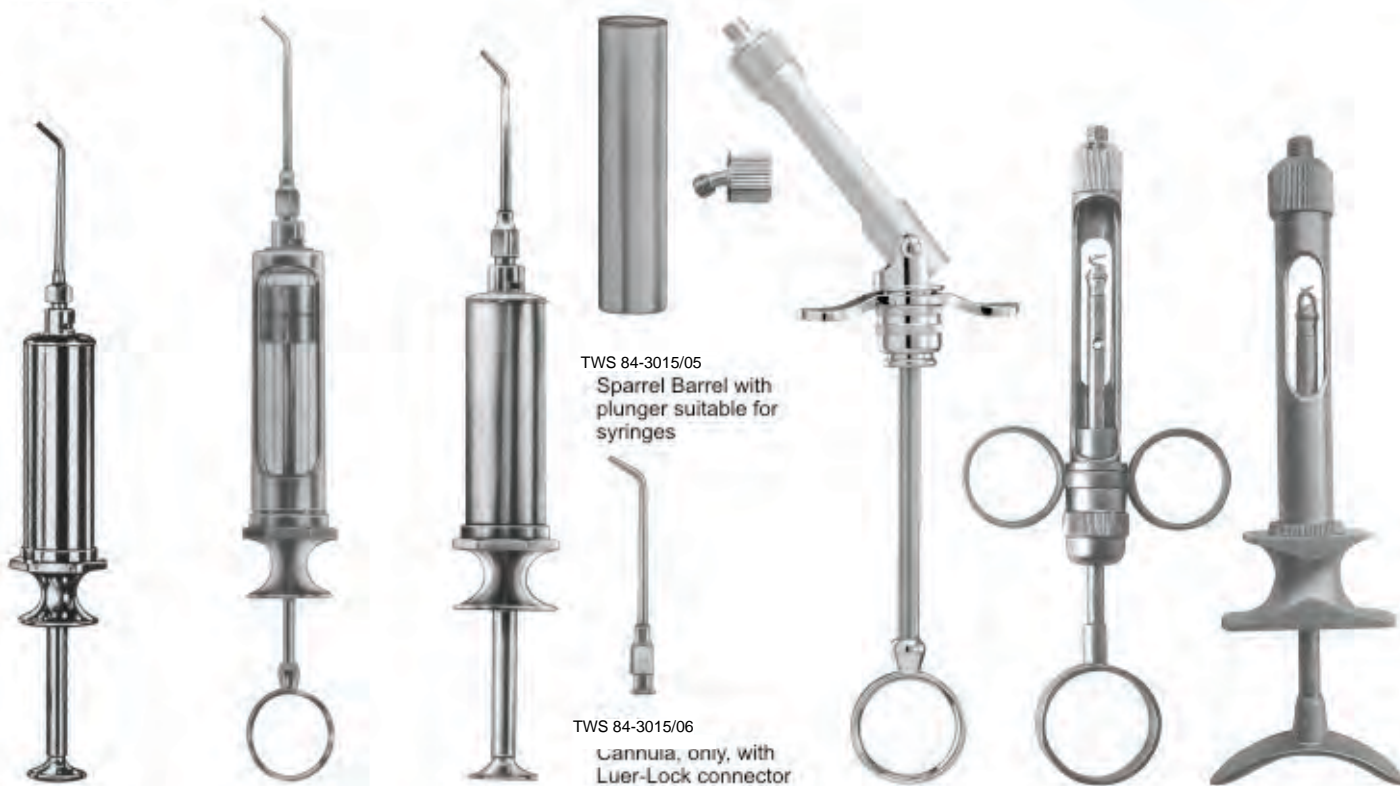

TWS 84-3015/05  
Sparrel Barrel with plunger suitable for syringes

TWS 84-3015/06  
Cannula, only, with Luer-Lock connector suitable for syringes

TWS 84-3015/07

Water Syringe complete with 1 cannula (Lure-Lock)

TWS 84-3015/08

Water Syringe complete with 1 cannula (Lure-Lock)

TWS 84-3015/09

Metal Water Syringe self-filling, with 1 cannula (Lure-Lock)

TWS 84-3015/10

Articulating Barrel Syringe

TWS 84-3015/11

ml 1,8

TWS 84-3015/12

ml 1,8



TWS 84-3015/14

TWS 84-3015/15



TWS 84-3015/16



TWS 84-3015/17

Fig. 1 ml 1,8 EU

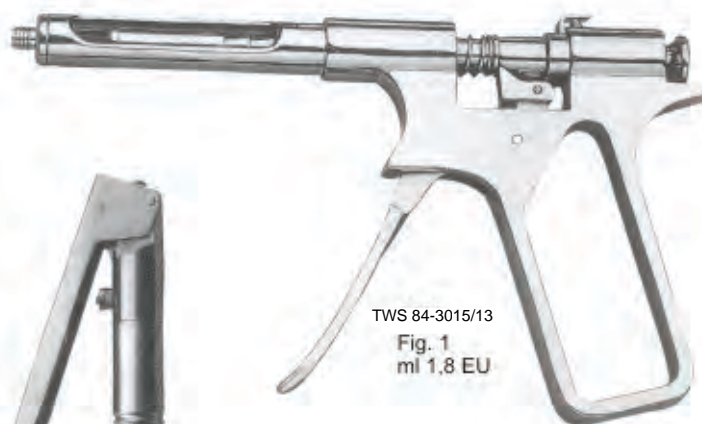

TWS 84-3015/13  
Fig. 1 ml 1,8 EU



TWS 84-3015/18

Water point

TWS 84-3015/19

Water point

TWS 84-3015/20

Water point

Treasure Wright (U.K.) Ltd.

128-160 City Road, London, EC1V 2NX, United Kingdom  
info@twrightmedical.com



TW Surgical

# Dental Tweezers



TWS 84-3015/22  
ADSON  
Curved 14 cm



TWS 84-3015/23  
ADSON  
1X2 / 12 cm



TWS 84-3015/24  
ADSON  
12 cm



TWS 84-3015/25  
MICRO ADSON  
15 cm



TWS 84-3015/26  
STANDARD  
14, 18, 25 cm



TWS 84-3015/27  
CUSHING  
18 cm



TWS 84-3015/21  
Curved



TWS 84-3015/28

TWS 84-3015/29  
SELECT  
15, 18, 20 cm



TWS 84-3015/30  
MCINDOE  
15 cm



TWS 84-3015/31  
GILLIES  
15 cm



TWS 84-3015/32  
WAUGH  
15, 20 cm



Serrated

TWS 84-3015/33  
PERRY  
13 cm



TWS 84-3015/34  
KOPP  
15.5 cm

Treasure Wright (U.K.) Ltd.

128-160 City Road, London, EC1V 2NX, United Kingdom  
info@twrightmedical.com



TW Surgical

# Dental Tweezers



TWS 84-3015/35  
COLLEGE  
15 cm



smooth



TWS 84-3015/36  
COLLEGE  
15 cm



serrated



TWS 84-3015/37  
COLLEGE  
15 cm



smooth



TWS 84-3015/38  
COLLEGE  
15 cm



serrated



TWS 84-3015/39  
COLLEGE  
15 cm



smooth



TWS 84-3015/40  
COLLEGE  
15 cm



serrated



TWS 84-3015/41  
COLLEGE  
15 cm



smooth



TWS 84-3015/42  
COLLEGE  
15 cm



serrated

Treasure Wright (U.K.) Ltd.

128-160 City Road, London, EC1V 2NX, United Kingdom  
info@twrightmedical.com



TW Surgical

## Dental Tweezers



TWS 84-3015/43  
MERIAM  
16 cm



smooth



TWS 84-3015/44  
MERIAM  
16 cm



serrated



TWS 84-3015/45  
MERIAM  
16 cm



smooth



TWS 84-3015/46  
MERIAM  
16 cm1



serrated



TWS 84-3015/47  
MERIAM  
16 cm



smooth



TWS 84-3015/48  
MERIAM  
16 cm



serrated



TWS 84-3015/49  
MERIAM  
16 cm



smooth



TWS 84-3015/50  
MERIAM  
16 cm



serrated

Treasure Wright (U.K.) Ltd.

128-160 City Road, London, EC1V 2NX, United Kingdom  
info@twrightmedical.com



TW Surgical

# Dental Tweezers

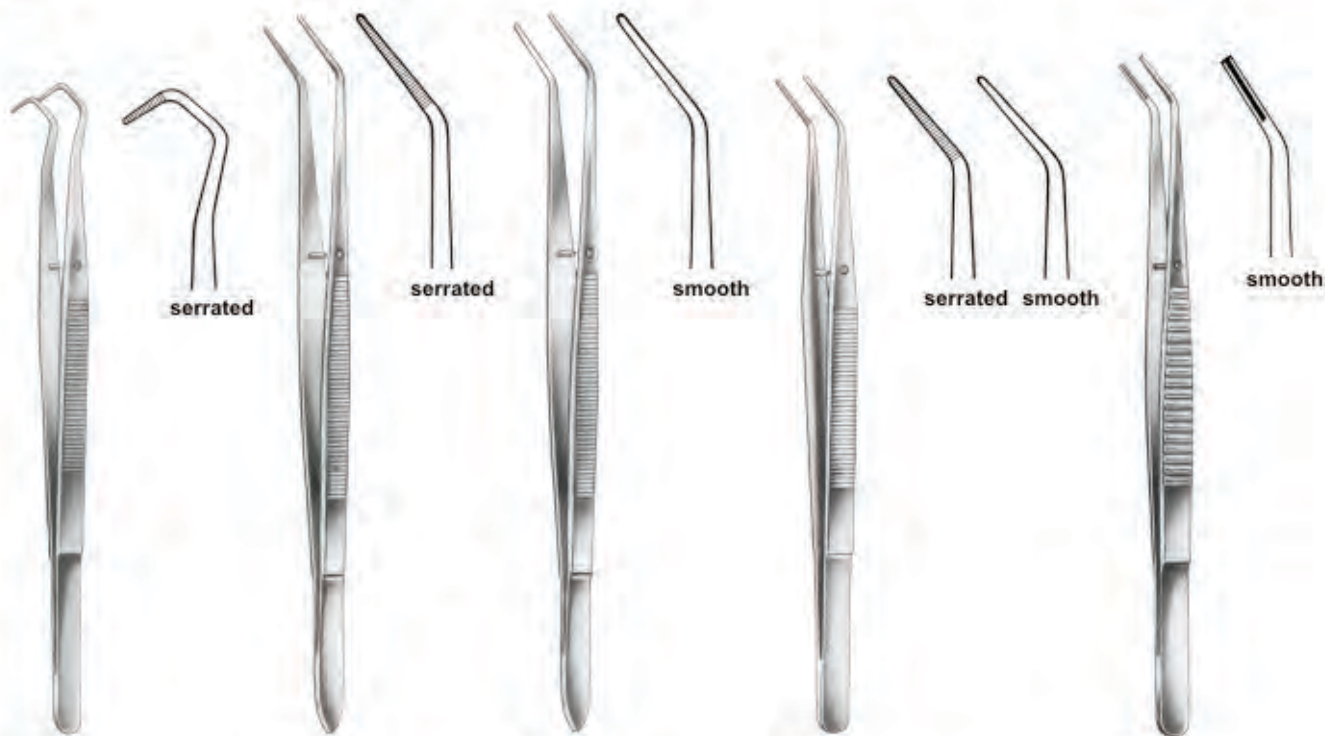

TWS 84-3015/51  
COLLEGE  
14.5 cm, 5<sup>3</sup>/<sub>4</sub>"

TWS 84-3015/52  
FLAGG  
16 cm, 6<sup>1</sup>/<sub>4</sub>"

TWS 84-3015/53  
FLAGG  
16 cm, 6<sup>1</sup>/<sub>4</sub>"

TWS 84-3015/54  
LANDGRAF  
15 cm, 6"

TWS 84-3015/55  
15.5 cm, 6<sup>1</sup>/<sub>8</sub>"

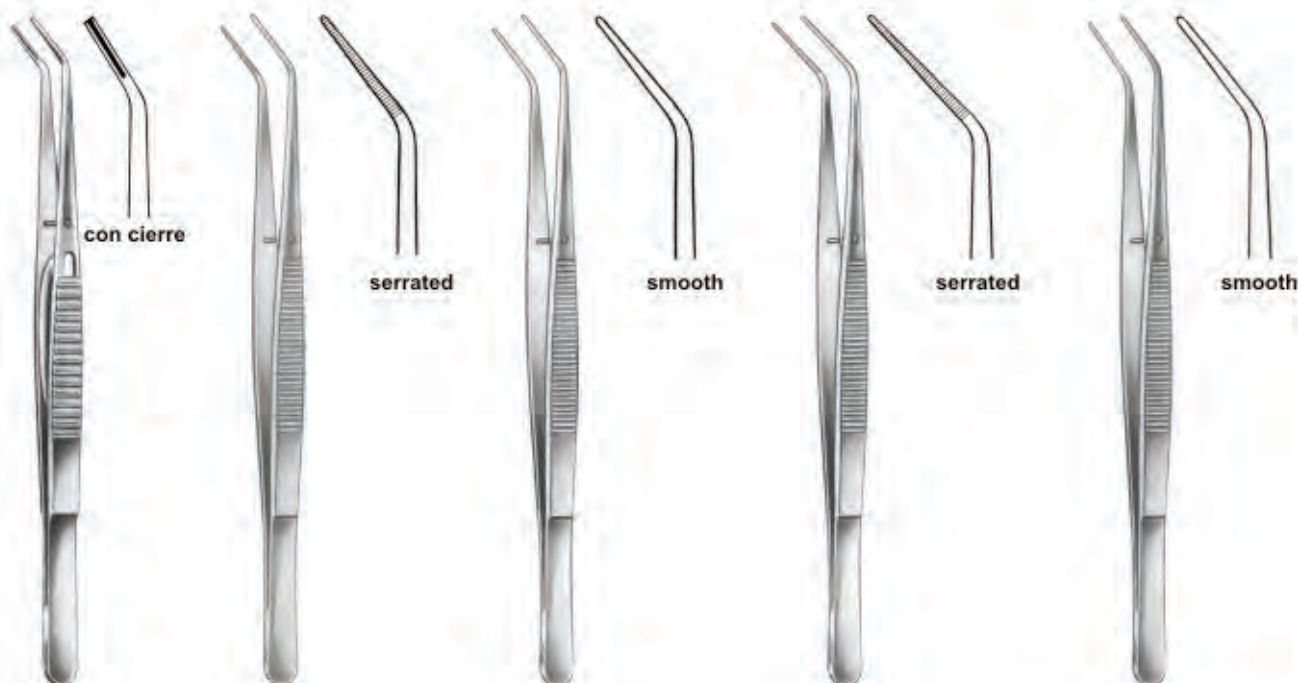

TWS 84-3015/56  
15.5 cm, 6<sup>1</sup>/<sub>8</sub>"

TWS 84-3015/57  
LONDON-COLLEGE  
15 cm, 6"

TWS 84-3015/58  
LONDON-COLLEGE  
15 cm, 6"

TWS 84-3015/59  
LONDON-COLLEGE  
15 cm, 6"

TWS 84-3015/60  
LONDON-COLLEGE  
15 cm, 6"

Treasure Wright (U.K.) Ltd.

128-160 City Road, London, EC1V 2NX, United Kingdom  
info@twrightmedical.com



TW Surgical

# Dental Tweezers



TWS 84-3015/61  
LONDON-COLLEGE  
15 cm, 6"



TWS 84-3015/62  
LONDON-COLLEGE  
15 cm, 6"



con cierre



TWS 84-3015/63  
MERIAM  
16 cm, 6 1/4"



serrated



smooth



TWS 84-3015/64  
ALLEN  
18 cm, 7 1/8"



TWS 84-3015/65  
ALBRECHT  
16 cm, 6 1/4"



TWS 84-3015/66  
ALBRECHT  
16 cm, 6 1/4"



TWS 84-3015/67  
16 cm, 6 1/4"



TWS 84-3015/68  
16 cm, 6 1/4"



TWS 84-3015/69  
16 cm, 6 1/4"



Treasure Wright (U.K.) Ltd.

128-160 City Road, London, EC1V 2NX, United Kingdom  
info@twrightmedical.com



TW Surgical

## Sterilizing & Lab Instruments



TWS 84-3015/70  
DAVIS  
6"



TWS 84-3015/71  
Grasping Forceps  
6 1/4"



TWS 84-3015/72  
Mesh Bur & Diamond Holder  
Large, 2 1/8" Diameter



TWS 84-3015/73  
Soldering Tweezers  
6 1/4"



TWS 84-3015/74  
Narrow Fine  
4 3/4"



TWS 84-3015/75  
Super Fine  
4 3/8"



TWS 84-3015/76  
Fine Curved  
4 1/2"



TWS 84-3015/77  
Bonding Bracket  
Holder  
136 mm



TWS 84-3015/78  
Bonding Bracket  
Holder  
135 mm



TWS 84-3015/79  
Bonding Bracket  
Holder  
135 mm



TWS 84-3015/80  
Bonding Bracket  
Holder  
140 mm

Treasure Wright (U.K.) Ltd.

128-160 City Road, London, EC1V 2NX, United Kingdom  
info@twrightmedical.com



TW Surgical

# Endodontic Forceps



TWS 84-3015/81  
Endo Forceps  
4 3/4"



TWS 84-3015/82  
PEETS Forceps  
4 3/4", Useful For  
Removing Broken  
Instruments



TWS 84-3015/83  
Without Ratchet  
145 mm

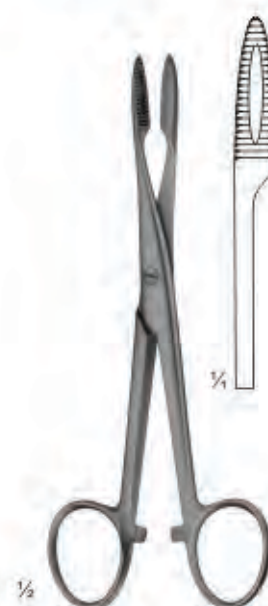

TWS 84-3015/84  
With Ratchet  
145 mm



TWS 84-3015/90  
CRILE  
140 mm



TWS 84-3015/85 130 mm  
TWS 84-3015/86 140 mm



TWS 84-3015/87 130 mm  
TWS 84-3015/88 150 mm  
TWS 84-3015/89 130 mm 150 mm

TWS 84-3015/91  
PEAN  
Slender type

TWS 84-3015/92  
SPENCER-WELLS

Treasure Wright (U.K.) Ltd.

128-160 City Road, London, EC1V 2NX, United Kingdom  
info@twrightmedical.com



TW Surgical

# Tissue Forceps



TWS 84-3015/93  
BABY-ALLIS  
5", Straight  
4x5 teeth extra delicate



TWS 84-3015/94  
ALLIS  
6", Straight  
4x5 teeth extra delicate



TWS 84-3015/95  
ALLIS  
6", Straight  
4x5 teeth extra delicate



TWS 84-3015/99  
1x2 teeth  
6"



TWS 84-3015/97  
SEMKIN  
6", Straight,  
1x2 teeth



TWS 84-3015/98  
ADSON  
4 3/4"  
1x2 teeth



TWS 84-3015/99  
BROWN-ADSON  
4 3/4"  
7x7 teeth



TWS 84-3016/00  
BROWN  
6"  
8x8 teeth



TWS 84-3016/01  
RUSSIAN  
6"  
8x8 teeth



TWS 84-3016/02  
Extra-Delicate,  
Straight, 4"  
1x2 teeth

Treasure Wright (U.K.) Ltd.

128-160 City Road, London, EC1V 2NX, United Kingdom  
info@twrightmedical.com



TW Surgical

## Hemostatic Forceps, Towel Clamps, Napkin Hold



TWS 84-3016/03  
HALSTED-MOSQUITO  
Straight, Curved, 5"



TWS 84-3016/04  
HALSTED-MOSQUITO  
Straight, Curved, 5"  
1x2 teeth



TWS 84-3016/05  
HALSTED-MOSQUITO  
Jaws 45 Angled on Flat, 5"  
Extra Delicate



TWS 84-3016/06  
KELLY  
5 1/2", Straight



TWS 84-3016/07  
JONES  
3 1/2"

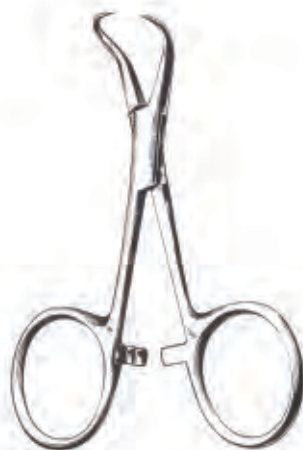

TWS 84-3016/08  
BACKHAUS  
3 1/2"



TWS 84-3016/09  
BACKHAUS  
5 1/4"



TWS 84-3016/10  
LORNA  
Non Perforated  
3 1/2"

Treasure Wright (U.K.) Ltd.

128-160 City Road, London, EC1V 2NX, United Kingdom  
info@twrightmedical.com



TW Surgical

# Retractors, Depressors, Mouth Gags

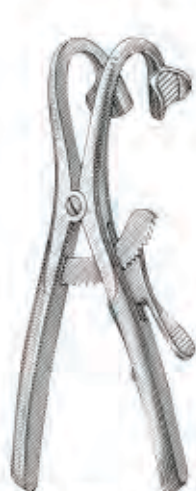

TWS 84-3016/11  
DENHART



TWS 84-3016/12  
DENHARDT  
Mouth Gag With  
Silicon Inserts,  
Interchangeable  
Size: 125 mm



TWS 84-3016/13  
WIEDER  
Tongue depressor  
2579 140mm  
2580 150mm



TWS 84-3016/14  
TOBOLD  
Tongue depressor  
Size: 145 mm



TWS 84-3016/18  
ANDREW  
Tongue depressor  
Size: 110 mm



TWS 84-3016/15  
WEITLANER  
Sharp  
130 mm



TWS 84-3016/16  
WEITLANER  
Sharp  
110 mm



TWS 84-3016/17  
WEITLANER  
Semi-Sharp  
110 mm



TWS 84-3016/19  
MOLT  
Pediatric



TWS 84-3016/20  
MOLT  
Child



TWS 84-3016/21  
MOLT  
Adult



TWS 84-3016/22  
FERGUSON-ACKLAND  
Mouth Gag  
Size: 145 mm



TWS 84-3016/23  
ROSER KOENIG  
Mouth Gag  
Size: 160mm / 185mm



TW Surgical

# Lip & Cheek Retractors



TWS 84-3016/24  
140 mm



TWS 84-3016/25  
BRUENINGS  
190 mm



TWS 84-3016/26



TWS 84-3016/27



TWS 84-3016/28



TWS 84-3016/29



TWS 84-3016/30



TWS 84-3016/31



TWS 84-3016/35



TWS 84-3016/36



TWS 84-3016/32  
Mouth Gag with  
Tongue Depressor  
11.0 cm  
13.0 cm  
15.0 cm



TWS 84-3016/33  
Mouth Gag without  
Tongue Depressor  
11.0 cm  
13.0 cm  
15.0 cm



TWS 84-3016/34  
Jennings, Mouth Gag  
11.0 cm  
13.0 cm  
15.0 cm



TW Surgical

# Lip & Cheek Retractor

- 30 x 4 mm A
- 23 x 7 mm B
- 24 x 11 mm C
- 29 x 10 mm D
- 30 x 11 mm E
- 32 x 14 mm F
- 40 x 11 mm G
- 42 x 10 mm H
- 50 x 11 mm I
- 55 x 11 mm J
- 60 x 11 mm K
- 70 x 11 mm L
- 70 x 14 mm M



TWS 84-3016/37  
LANGENBECK  
210 mm



TWS 84-3016/38  
KOCHER-LANGENBECK  
215 mm



TWS 84-3016/39  
BUCHS  
205 mm



38 x 18 mm



TWS 84-3016/40  
KOCHER  
230 mm



TWS 84-3016/43  
MIDDELDORPF



TWS 84-3016/41  
15 x 15 mm  
220 mm



TWS 84-3016/42  
20 x 22 mm  
215 mm



TWS 84-3016/44  
28 x 28 mm  
235 mm



TWS 84-3016/45  
KOCHER  
230 mm



TWS 84-3016/46  
COLLIN  
150 mm



TWS 84-3016/47  
ROUX  
Set  
165 mm

Treasure Wright (U.K.) Ltd.

128-160 City Road, London, EC1V 2NX, United Kingdom  
info@twrightmedical.com



TW Surgical

## Sterilizing Forceps



TWS 84-3016/48  
Sterilizing Forcep Curved  
20 cm A  
25 cm B  
30 cm C



TWS 84-3016/49  
Sterilizing Forcep Straight  
20 cm A  
25 cm B  
30 cm C



TWS 84-3016/50  
Sterilizing Forcep  
30 cm



TWS 84-3016/51  
Becht Tweezer



TWS 84-3016/52  
Sterilizing Forcep  
23 cm A  
30 cm B



TWS 84-3016/53  
Sterilizing Forcep  
20 cm

Treasure Wright (U.K.) Ltd.

128-160 City Road, London, EC1V 2NX, United Kingdom  
info@twrightmedical.com



TW Surgical

## Tissue Retractors & Hooks



TWS 84-3016/54  
3 sharp prongs



TWS 84-3016/55  
2 sharp prongs  
6"



TWS 84-3016/56  
2 sharp prongs  
6"



TWS 84-3016/57  
FOMON  
145 mm



TWS 84-3016/58  
ALM  
70 mm



TWS 84-3016/59  
SENN  
3 sharp prongs  
6 3/8"



TWS 84-3016/60  
TOENNIS  
Dura Retractor  
150mm



TWS 84-3016/61  
JOSEPH  
165 mm



TWS 84-3016/62  
GILLIES  
180 mm

Treasure Wright (U.K.) Ltd.

128-160 City Road, London, EC1V 2NX, United Kingdom  
info@twrightmedical.com



TW Surgical

## Orthodontic Pliers



TWS 84-3016/63  
Light Wire Cutter



TWS 84-3016/64  
Wire Cutter



TWS 84-3016/65  
Posterior Band Remover  
Long



TWS 84-3016/66  
Posterior Band Remover  
Short



TWS 84-3016/67  
Jarabak Plier



TWS 84-3016/68  
Distal End Cutter  
Safety End Cutter



TWS 84-3016/69  
Distal End Cutter



TWS 84-3016/70  
Kim's Plier



TWS 84-3016/71  
Loop Forming Plier



TWS 84-3016/72  
Tweed Arch Bending Plier



TWS 84-3016/73  
Utility Plier



TWS 84-3016/74  
Bonding Bracket Remover



TWS 84-3016/75  
Lingual Arch Plier



TWS 84-3016/76  
Light Wire Plier



TWS 84-3016/77  
Wire Cutter  
12.5 cm

Treasure Wright (U.K.) Ltd.

128-160 City Road, London, EC1V 2NX, United Kingdom  
info@twrightmedical.com



TW Surgical

## Orthodontic Pliers

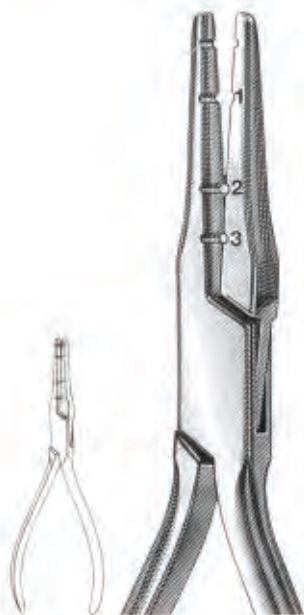

TWS 84-3016/78  
Fig. 101  
Wire Bending

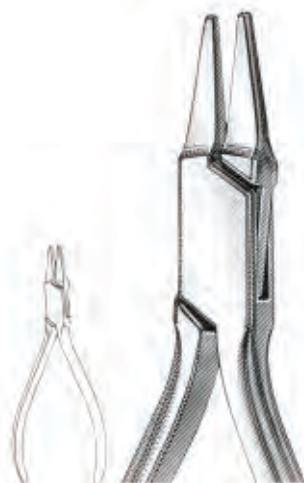

TWS 84-3016/79  
Fig. 118  
PEESO  
Collar

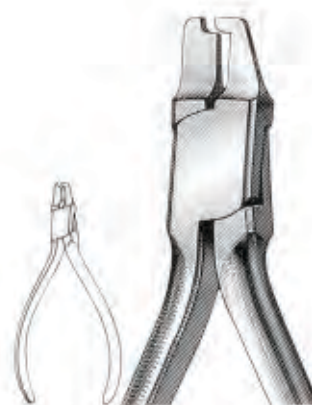

TWS 84-3016/80  
Fig. 417  
Crown Shell

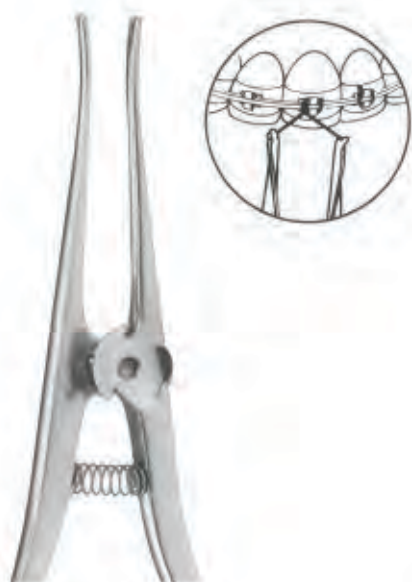

TWS 84-3016/81  
STEINER  
150 mm  
Ligature Pliers

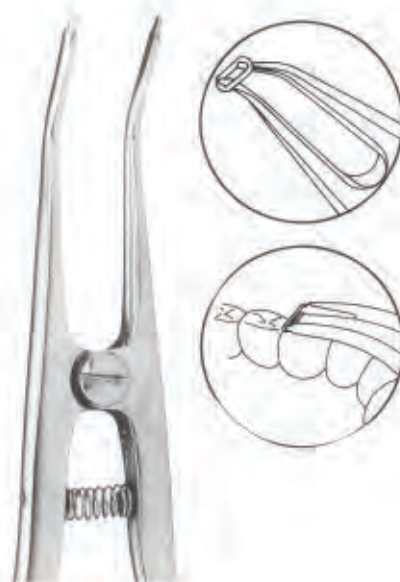

TWS 84-3016/82  
Separating Pliers Elastics  
150 mm

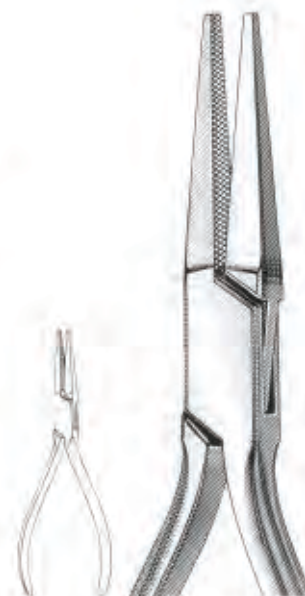

TWS 84-3016/83  
121-Lab & Office

Treasure Wright (U.K.) Ltd.

128-160 City Road, London, EC1V 2NX, United Kingdom  
info@twrightmedical.com



TW Surgical

# Orthodontic Pliers



TWS 84-3016/84  
How Plier-Titanium Alloy  
With special coated beaks



TWS 84-3016/85  
How Plier  
Tips are 1/8" (3.2mm)  
diameter



TWS 84-3016/86  
How Plier  
Tips are 1/8" (3.2mm)  
diameter



TWS 84-3016/87  
How Plier-Small  
Tips are 3/32" (2.4mm)  
diameter



TWS 84-3016/88  
How Plier-Offset  
Tips are 1/8" (3.2mm)  
diameter



TWS 84-3016/89  
Weingart Utility Plier  
-Titanium Alloy  
with special coated beaks

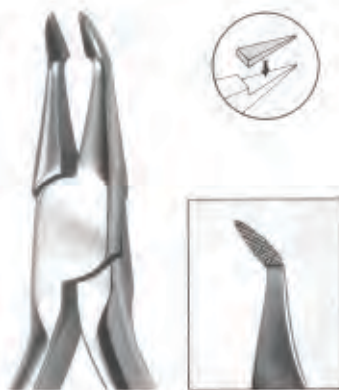

TWS 84-3016/90  
Weingart Utility Plier  
New type of the Weingart Utility Plier  
designed for a more precise operation.



TWS 84-3016/91  
Weingart Utility Plier



TWS 84-3016/92  
Weingart Utility Plier

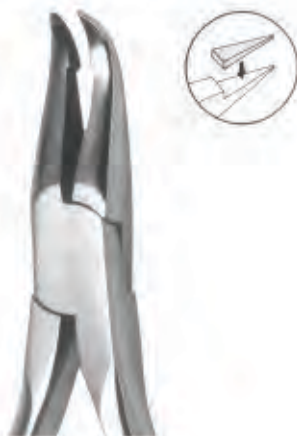

TWS 84-3016/93  
Weingart Utility Plier



TWS 84-3016/94  
Bird Beak Plier With Cutter  
**Maximum Bending & Cutting Capacity:**  
Wires up to .032"



TWS 84-3016/95  
Bird Beak Plier  
**Maximum Bending Capacity:**  
Wires up to .032"



TWS 84-3016/96  
Bird Beak Plier  
**Maximum Bending Capacity:**  
Wires up to .030"

Treasure Wright (U.K.) Ltd.

128-160 City Road, London, ECLV 2NX, United Kingdom  
info@twrightmedical.com



TW Surgical

# Orthodontic Pliers



TWS 84-3017/01  
TWEED (Fig. 98)  
13 cm, 5 1/8"  
Tweed Loop Omega Pliers.



TWS 84-3016/97  
TWEED - (Fig. 90)  
14 cm, 5 1/2"



TWS 84-3016/98  
O'BRIEN - (Fig. 97)  
14 cm, 5 1/2"



TWS 84-3016/99  
TWEED (Fig. 96)  
14 cm, 5 1/2"



TWS 84-3017/00  
TWEED (Fig. 95)  
13.5 cm, 5 1/4"



TWS 84-3017/02  
SCHWARZ (Fig. 29)  
12.5 cm, 5"



TWS 84-3017/03  
NANCE (Fig. 80)  
13 cm, 5 1/8"



TWS 84-3017/04  
YOUNG (Fig. 55)  
13 cm, 5 1/8"



TWS 84-3017/05  
SCHWARZ (Fig. 30)  
13 cm, 5 1/8"



TWS 84-3017/06  
Optical Plier (Fig. 53)  
14 cm, 5 1/2"

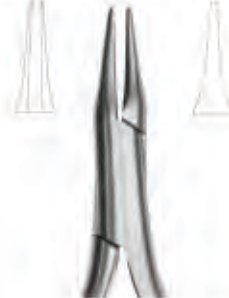

TWS 84-3017/07  
Schwarz (Fig. 79)  
13.5 cm, 5 1/4"

Treasure Wright (U.K.) Ltd.

128-160 City Road, London, EC1V 2NX, United Kingdom  
info@twrightmedical.com



TW Surgical

# Orthodontic Pliers



TWS 84-3017/10  
NANCE (Fig. 56)  
12.5 cm, 5"  
Wire bending Pliers



TWS 84-3017/08  
JOHNSON (Fig. 59)  
13.5 cm, 5 1/4"  
Contouring Plier.



TWS 84-3017/09  
REYNOLDS (Fig. 61)  
13 cm, 5 1/8"  
Contouring Plier.



TWS 84-3017/11  
De La Rosa (Fig. 34)  
12.5 cm, 5"  
Contouring Plier, Non-Grooved



TWS 84-3017/12  
De La Rosa (Fig. 35)  
12.5 cm, 5"  
Contouring Plier, Grooved



TWS 84-3017/16  
14.0 cm  
Goslee Contouring Plier



TWS 84-3017/13  
14.0 cm  
Goslee Contouring Plier



TWS 84-3017/14



TWS 84-3017/15  
Fig. 58  
12.5 cm, 5"  
Lingual Arch Bending Plier



TWS 84-3017/17  
Frevert/Tweed (Fig. 51)  
12.5 cm, 5"  
Tweed Arch Plier/Standard Jaw



TWS 84-3017/18



TWS 84-3017/19  
ANGLE (Fig. 52)  
13 cm, 5 1/8"  
Arch Forming Pliers

Treasure Wright (U.K.) Ltd.

128-160 City Road, London, EC1V 2NX, United Kingdom  
info@twrightmedical.com



TW Surgical

## Orthodontic Pliers



TWS 84-3017/22  
Fig. 60  
13 cm, 5 1/8"  
Wire & Clasp Bending Pliers



TWS 84-3017/20  
Fig. 60  
13 cm, 5 1/8"  
Wire & Clasp Bending Pliers

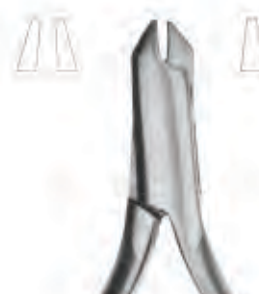

TWS 84-3017/21  
Aderer (Fig. 57)  
12 cm, 4 3/4"  
Wire & Clasp Bending Pliers



TWS 84-3017/23  
49 e 49 TC  
14 cm, 5 1/2"  
Band Removing Plier, short pad



TWS 84-3017/24  
50 e 50 TC  
14 cm, 5 1/2"  
Band Removing Plier, long pad



TWS 84-3017/25  
Fig. 84  
14.5 cm, 5 3/4"  
Band pinshing & ligature  
locking plier, serrated



TWS 84-3017/26  
Fig. 72  
14 cm, 5 1/2"  
Band pinshing & ligature  
locking plier, serrated



TWS 84-3017/27  
BRACKET (Fig. 82)  
13.5 cm, 5 1/4"  
Direct Bonding Bracket Remover



TWS 84-3017/28  
BRACKET (Fig. 83)  
13.5 cm, 5 1/4"  
Direct Bonding  
Bracket Remover

# Orthodontic Pliers



TWS 84-3017/31  
38c, 38TC  
13.5 cm, 5 1/4"  
Contouring closing loop pliers,  
wire bending, cutter.



TWS 84-3017/29  
40c, 40TC  
13.5 cm, 5 1/4"  
Contouring pliers light wire pliers  
grooved with cutter.



TWS 84-3017/30  
Fig. 81  
12.5 cm, 5"  
Sling clasp & wire bending plier



TWS 84-3017/33  
Fig. 28  
14 cm, 5 1/2"  
Sling clasp & wire bending plier.



TWS 84-3017/32  
Fig. 21  
13 cm, 5 1/8"  
Light wires pliers, grooved

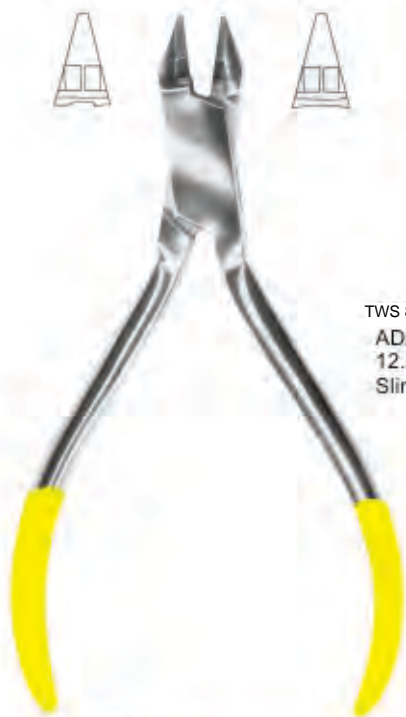

TWS 84-3017/37  
46c - 46 TC  
ADAMS - N. 139c  
12.5 cm, 5"  
Bird beak with cutter.



TWS 84-3017/34  
ADAMS, 23, 23TC  
12.5 cm, 5"  
Sling clasp & wire bending plier.



TWS 84-3017/35  
ADAMS (Fig. 33)  
12.5 cm, 5"  
For retaining elements.



TWS 84-3017/36  
ADAMS (Fig. 44)  
12.5 cm, 5"  
Sling clasp & wire bending plier



TWS 84-3017/38  
Universal Wire Bending  
Pliers (ADAMS) 47 TC, N.64  
12.5 cm, 5"  
Sling clasp & wire bending plier.



TWS 84-3017/39  
86c, 86 TC  
Angle Bird Beak - N.138  
12.5 cm, 5"  
Sling clasp & wire bending plier.



TW Surgical

# Orthodontic Cutters With T.C.



Ø 1.0 mm  
(0.40")

TWS 84-3017/42  
Fig. 18 TC  
15 cm, 6"



Ø 1.0 mm  
(0.40")

TWS 84-3017/40  
Fig. 92 TC  
14 cm, 5 1/8"



Ø 0.4 mm  
(0.16")

TWS 84-3017/41  
Fig. 91 TC  
13 cm, 5 1/8"



Ø 0.4 mm  
(0.16")

TWS 84-3017/43  
Fig. 99 TC  
13 cm, 5 1/8"



Ø 0.4 mm  
(0.16")

TWS 84-3017/44  
Fig. 94 TC  
13 cm, 5 1/8"  
Angled at 15° with or  
without spring on \  
the handles.



TWS 84-3017/45  
Fig. 85 TC  
13 cm, 5 1/8"



TWS 84-3017/46  
Fig. 87 TC  
13 cm, 5 1/8"



TWS 84-3017/47  
Fig. 85 TC  
Angled at 15°  
13 cm, 5 1/8"



TWS 84-3017/48  
ADAMS 87 TC  
Angled at 15°  
13 cm, 5 1/8"



TW Surgical

## Orthodontic Distal & Cutters



Treasure Wright (U.K.) Ltd.

128-160 City Road, London, EC1V 2NX, United Kingdom  
info@twrightmedical.com



TW Surgical

# Pliers for Orthodontic & Prosthetics



TWS 84-3017/57  
UNIVERSAL  
150 mm



TWS 84-3017/54  
WALDSACHS  
155 mm



TWS 84-3017/55  
ADERER  
125 mm



TWS 84-3017/56  
NANCE  
125 mm



TWS 84-3017/58  
REYNOLDS  
125 mm



TWS 84-3017/59  
HOW  
145 mm



TWS 84-3017/60  
HOW  
140 mm



TWS 84-3017/64  
FURRER  
150 mm



TWS 84-3017/61  
WALDRON  
125 mm



TWS 84-3017/62  
ADAMS  
125 mm



TWS 84-3017/63  
ANGLE  
125 mm



TWS 84-3017/65  
YOUNG  
130 mm



TWS 84-3017/66  
NANCE  
130 mm

Treasure Wright (U.K.) Ltd.

128-160 City Road, London, EC1V 2NX, United Kingdom  
info@twrightmedical.com



TW Surgical

## Pliers for Orthodontic & Prosthetics



TWS 84-3017/67  
LANGEBECK  
125 mm



TWS 84-3017/68  
LANGEBECK  
140 mm



TWS 84-3017/69  
LANGEBECK  
130 mm



TWS 84-3017/70  
PEESO  
125 mm



TWS 84-3017/71  
GOSLEE  
125 mm



TWS 84-3017/72  
FISCHER  
140 mm



TWS 84-3017/73  
FISCHER  
140 mm



TWS 84-3017/74  
JOHNSON  
130 mm



TWS 84-3017/75  
MSY  
130 mm



TWS 84-3017/76  
MC KELLOPS  
155 mm



TWS 84-3017/77  
ANDRESEN  
130 mm



TWS 84-3017/78  
SCHWARZ  
130 mm

Treasure Wright (U.K.) Ltd.

128-160 City Road, London, EC1V 2NX, United Kingdom  
info@twrightmedical.com



TW Surgical

# Rongeurs



TWS 84-3017/81  
BLUMENTHAL  
6", 30°, Standard



TWS 84-3017/79  
MINI-BLUMENTHAL  
6", 45°

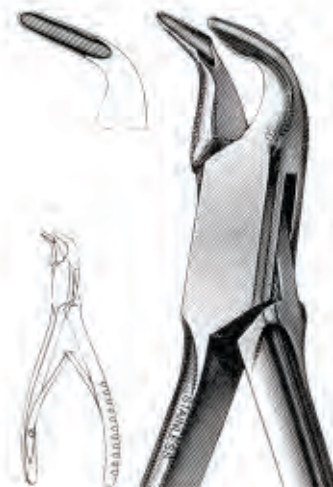

TWS 84-3017/80  
MINI-BLUMENTHAL  
6", 90°

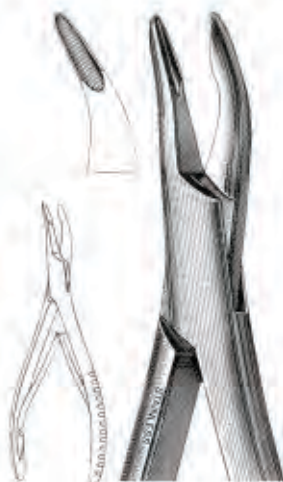

TWS 84-3017/82  
BLUMENTHAL  
7", 30°



TWS 84-3017/83  
MINI-BLUMENTHAL  
4 1/2", 30°

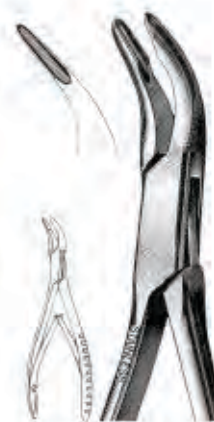

TWS 84-3017/84  
MINI-BLUMENTHAL  
4 1/2", 45°



TW Surgical

# Rongeurs



TWS 84-3017/89  
CLEVELAND  
No. 5-Side Cutting,  
6 3/4"

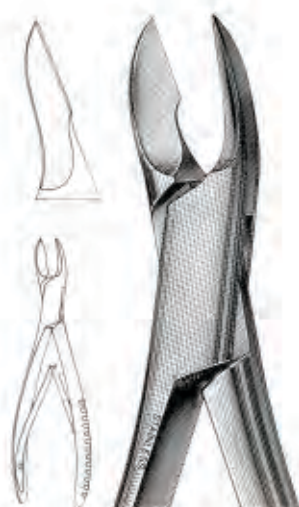

TWS 84-3017/85  
CLEVELAND  
No. 5A-Side Cutting,  
6 1/2"

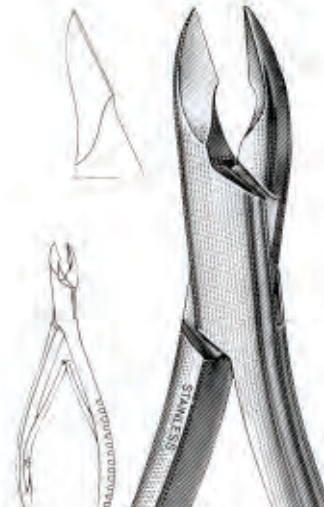

TWS 84-3017/86  
CLEVELAND  
No. 5S-Side Cutting,  
6"

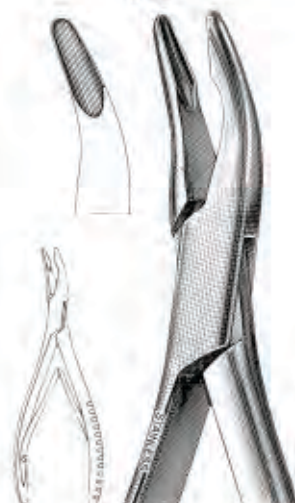

TWS 84-3017/87  
No. 1A-MEAD  
6 1/2"

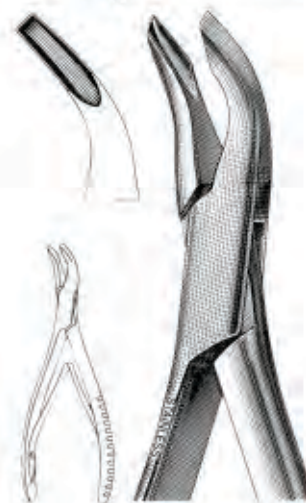

TWS 84-3017/88  
MEAD, Square  
No. 2A  
Tips, 6 1/2"



Treasure Wright (U.K.) Ltd.

128-160 City Road, London, EC1V 2NX, United Kingdom  
info@twrightmedical.com



TW Surgical

# Rongeurs



TWS 84-3017/93  
FRIEDMAN  
5 1/2"

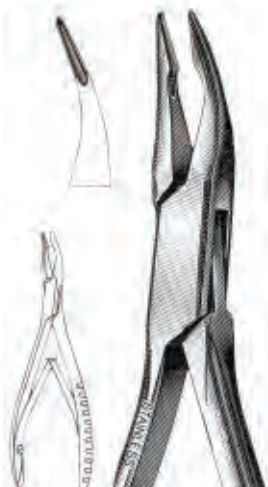

TWS 84-3017/90  
MICRO-FRIEDMAN  
5 1/2", 15° Curved Jaws



TWS 84-3017/91  
MICRO-FRIEDMAN  
Perio Rongeur, 5 1/2"

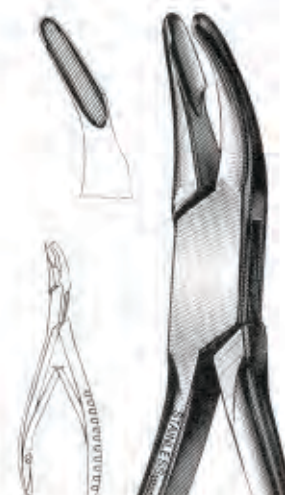

TWS 84-3017/92  
CLEVELAND  
No. 4 - 5 1/2"

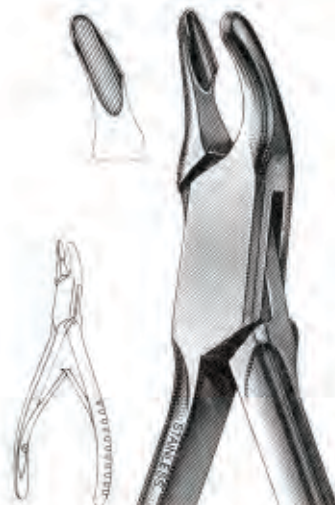

TWS 84-3017/94  
CLEVELAND  
No. 4A - 6 1/2"

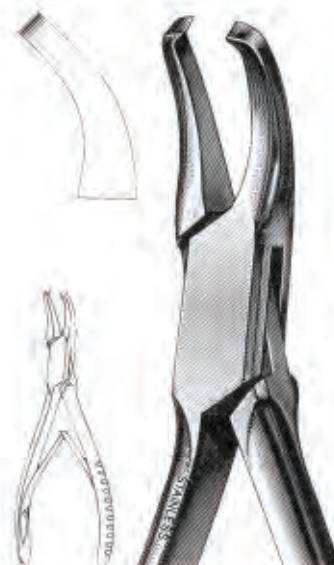

TWS 84-3017/95  
GARDNER  
No. 6A, End Cutting  
6 1/2"

Treasure Wright (U.K.) Ltd.

128-160 City Road, London, EC1V 2NX, United Kingdom  
info@twrightmedical.com



TW Surgical

# Rongeurs



TWS 84-3017/98  
**BEYER**  
Double Action,  
16,18 cm



TWS 84-3017/99  
**No. 1**  
6 1/2"

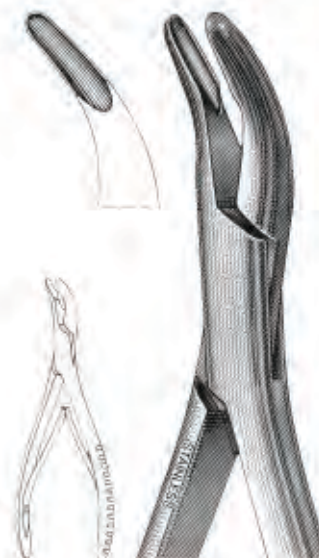

TWS 84-3017/97  
**HARTMAN**  
5 3/4"  
Strong Curve

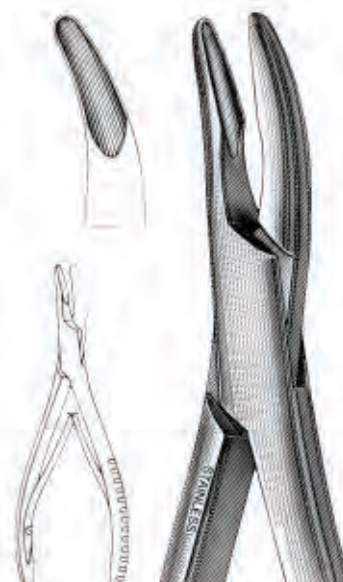

TWS 84-3018/00  
**BANE**  
Slight Curve  
7"

Treasure Wright (U.K.) Ltd.

128-160 City Road, London, EC1V 2NX, United Kingdom  
info@twrightmedical.com



TW Surgical

## Needle Holders



TWS 84-3018/01  
COLLIER  
5", Fenestrated Jaws



TWS 84-3018/02  
DERF  
4 3/4"



TWS 84-3018/03  
WEBSTER  
Delicate Smooth Jaws  
5"

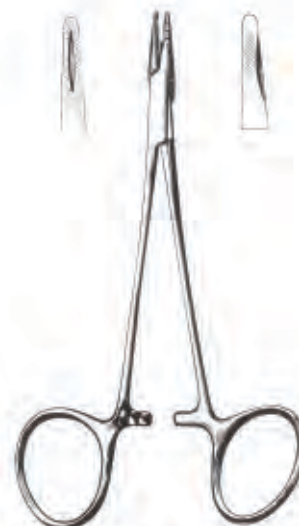

TWS 84-3018/04  
NEIVERT  
One Offset Ring  
5"



TWS 84-3018/05  
OLSEN-HEGAR  
5 1/2"



TWS 84-3018/06  
BAUMGARTNER  
5 1/4"



TWS 84-3018/07  
CRILE-WOOD  
6"



TWS 84-3018/08  
GARDNER  
5"

Treasure Wright (U.K.) Ltd.

128-160 City Road, London, EC1V 2NX, United Kingdom  
info@twrightmedical.com



TW Surgical

# Needle Holders

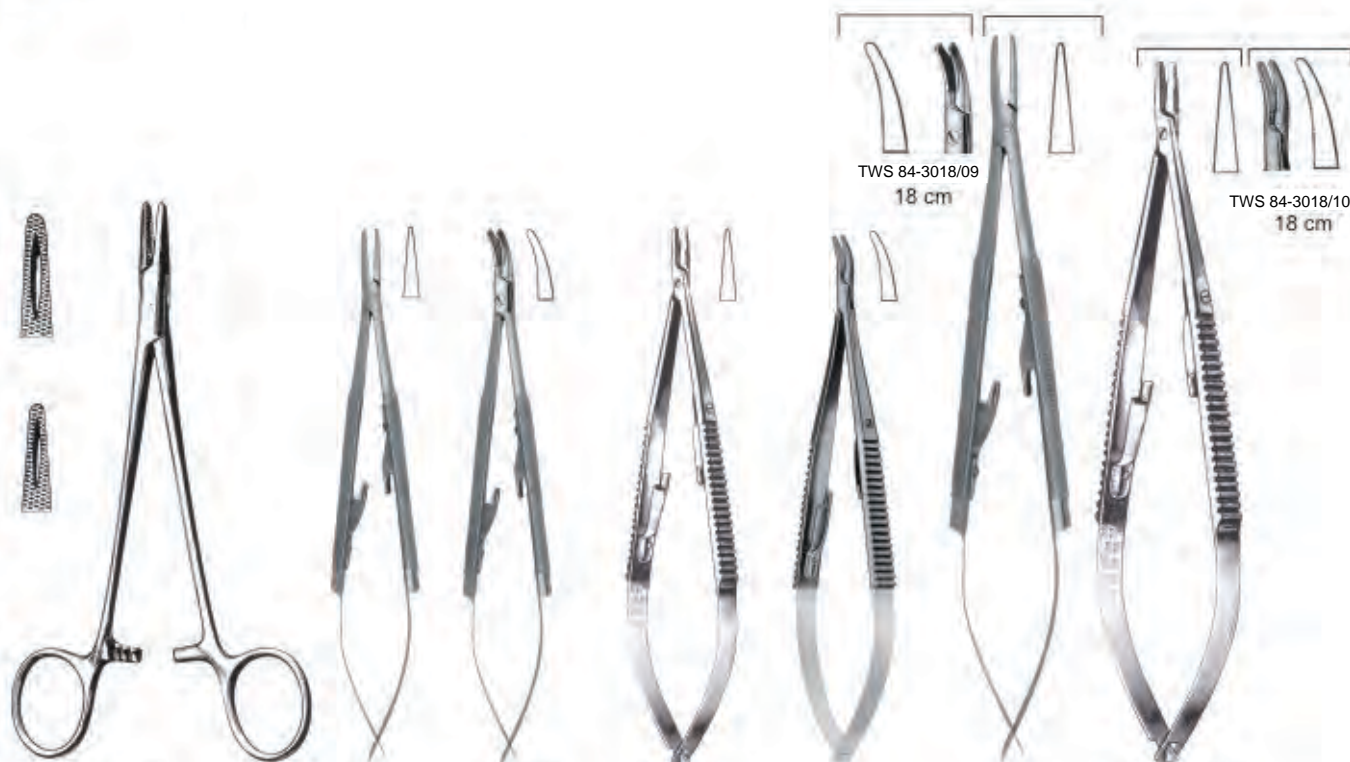

TWS 84-3018/11  
MAYO-HEGAR  
5"

TWS 84-3018/12  
CASTROVIEJO  
Smooth Jaws  
14 cm

TWS 84-3018/13  
CASTROVIEJO  
Smooth Jaws  
14 cm

TWS 84-3018/14  
CASTROVIEJO  
Smooth Jaws  
14 cm

TWS 84-3018/15  
CASTROVIEJO  
Smooth Jaws  
14 cm

TWS 84-3018/16  
CASTROVIEJO  
Smooth Jaws  
18 cm

TWS 84-3018/17  
CASTROVIEJO  
Smooth Jaws  
18 cm



TWS 84-3018/18  
BOYNTON  
5"



TWS 84-3018/19  
CRILE  
6"



TWS 84-3018/20  
MATHIEU  
5 1/2"



TWS 84-3018/21  
STEVENS  
6 1/2"

Treasure Wright (U.K.) Ltd.

128-160 City Road, London, EC1V 2NX, United Kingdom  
info@twrightmedical.com



TW Surgical

# Micro Surgery Set



TWS 84-3018/22  
Micro Scissor  
Straight, 155 mm



TWS 84-3018/23  
Micro Scissor  
Straight, 150 mm



TWS 84-3018/24  
Micro Scissor  
Curved, 150 mm



TWS 84-3018/25  
Micro Scissor  
Curved, 155 mm



TWS 84-3018/26  
CASTROVIEJO  
T.C.  
Straight, 180 mm



TWS 84-3018/27  
Retractor  
Fig.3  
165 mm



TWS 84-3018/28  
Micro Adson  
120 mm



TWS 84-3018/29  
GERALD  
Curved,  
180 mm



TWS 84-3018/30  
GERALD  
Straight,  
175 mm



TWS 84-3018/31  
Micro Adson  
160 mm

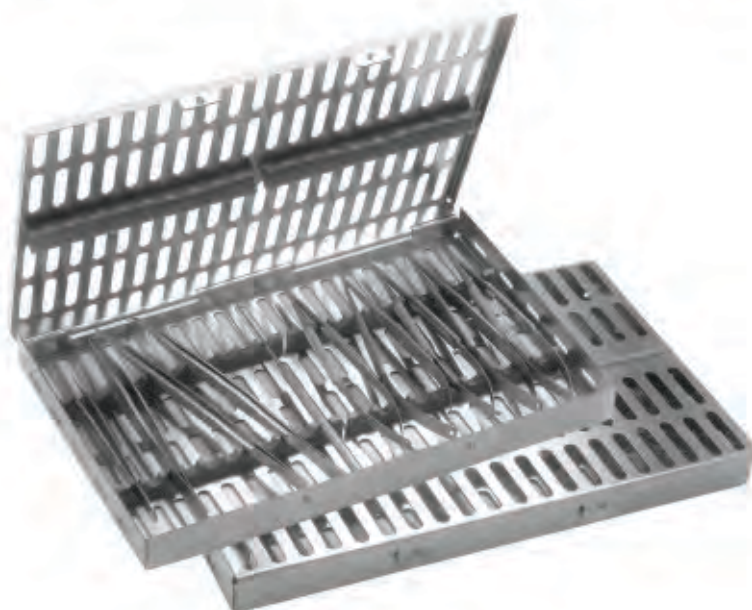

TWS 84-3018/32  
Micro Surgery Set 10 Pieces.

Treasure Wright (U.K.) Ltd.

128-160 City Road, London, EC1V 2NX, United Kingdom  
info@twrightmedical.com



TW Surgical

# Scissors

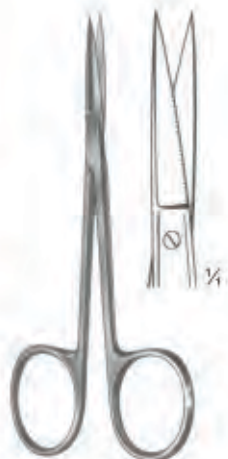

TWS 84-3018/37  
IRIS (Standard)  
Straight  
11.5 cm, 4 1/2"



TWS 84-3018/38  
IRIS (Standard)  
Curved  
11.5 cm, 4 1/2"



TWS 84-3018/39  
STEVENS  
Dissecting Scissors  
Size: 115 mm



1/4  
TWS 84-3018/33  
Sharp



TWS 84-3018/34  
Sharp



TWS 84-3018/35  
Blunt



TWS 84-3018/36  
Blunt



TWS 84-3018/40



1/2  
TWS 84-3018/45  
JOSEPH  
Size: 150 mm

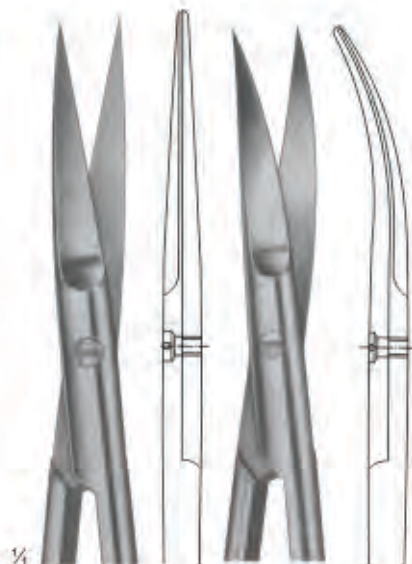

1/4  
TWS 84-3018/41

TWS 84-3018/42

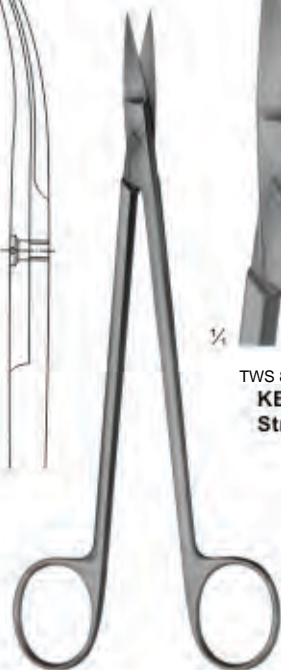

1/2  
TWS 84-3018/46  
KELLY  
Size: 175 mm



1/4  
TWS 84-3018/43  
KELLY  
Straight

TWS 84-3018/44  
KELLY  
Curved



1/2  
TWS 84-3018/47  
QUINBY  
Size: 130 mm

Treasure Wright (U.K.) Ltd.

128-160 City Road, London, EC1V 2NX, United Kingdom  
info@twrightmedical.com



TW Surgical

# Scissors



TWS 84-3018/48  
Standard - Types  
Size: 115 mm

TWS 84-3018/49  
DEEVER  
With flat lock

TWS 84-3018/50  
Size: 145 mm

TWS 84-3018/51  
Size: 145 mm

TWS 84-3018/52  
Size: 145 mm

TWS 84-3018/53  
LITTLER  
Dissecting Scissors  
Size: 115 mm



TWS 84-3018/54  
COTTLE  
Bulldog Scissors  
Size: 115 mm

TWS 84-3018/55  
DE BAKEY  
Ateriotomy scissors  
Size: 175 mm

TWS 84-3018/56  
TOENNIS - ADSON  
Dissecting scissors  
Size: 175 mm

TWS 84-3018/57  
KNOWLES  
Size: 145 mm

TWS 84-3018/58  
LISTER

Treasure Wright (U.K.) Ltd.

128-160 City Road, London, EC1V 2NX, United Kingdom  
info@twrightmedical.com



TW Surgical

# Scissors

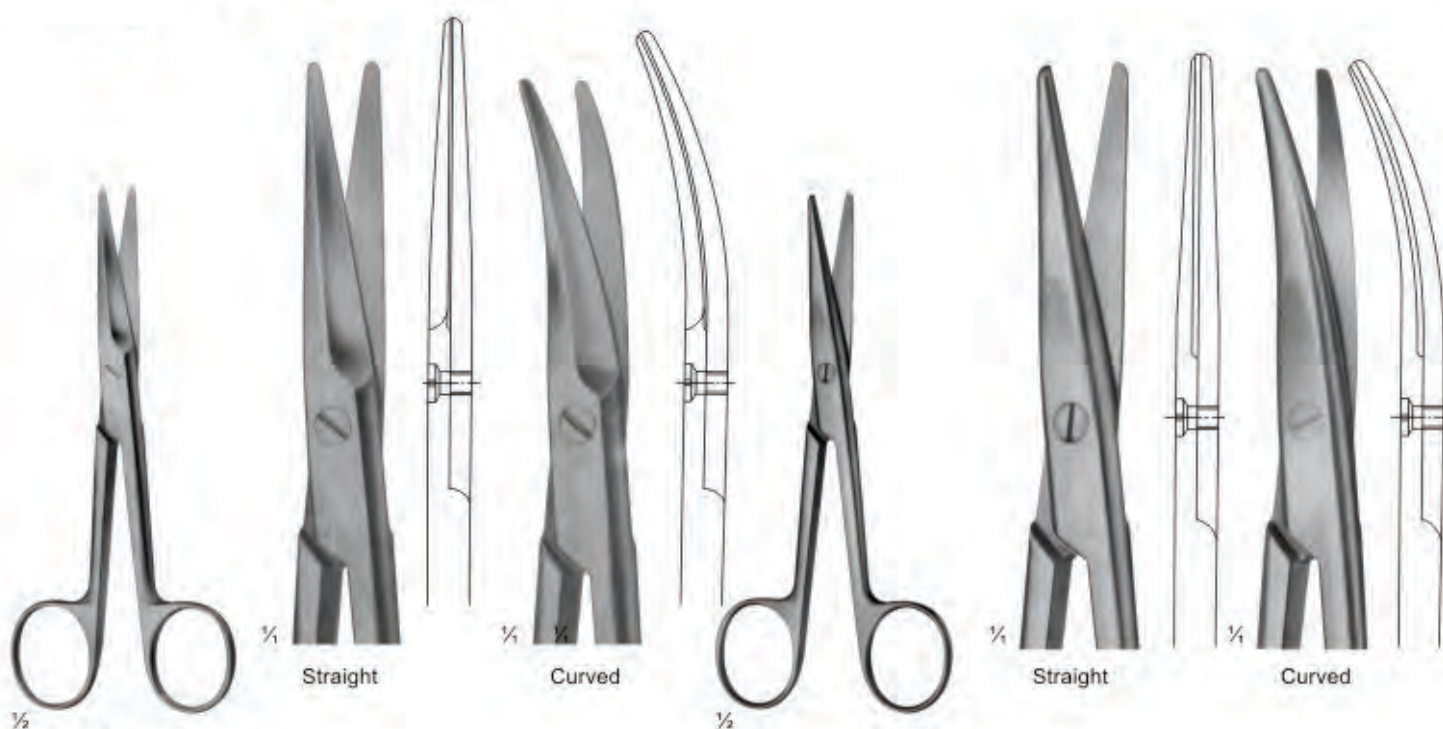

TWS 84-3018/59  
MAYO(straight)  
Size: 140 mm

TWS 84-3018/60  
MAYO-STILLE (straight)  
Size: 140 mm



TWS 84-3018/61  
STILLE  
Size: 140 mm

TWS 84-3018/62  
METZENBAUM  
Size: 145 mm

TWS 84-3018/63  
NELSON-METZENBAUM  
Size: 230 mm

Treasure Wright (U.K.) Ltd.

128-160 City Road, London, EC1V 2NX, United Kingdom  
info@twrightmedical.com



TW Surgical

# Scissors

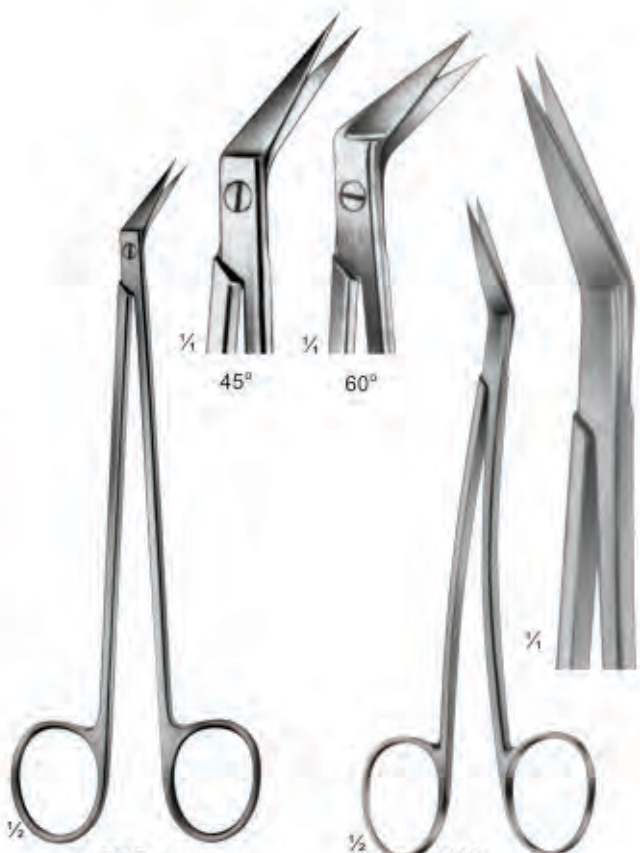

TWS 84-3018/66  
**DE BAKEY**  
Size: 155 mm

TWS 84-3018/67  
**LOCKLIN**  
Curved Sideways,  
1 Toothed Blade  
Size: 155 mm



TWS 84-3018/66  
**LaGrange**  
Double-Curved  
11.5 cm

TWS 84-3018/67  
**Goldman-Fox**  
Double-Curved  
13cm



TWS 84-3018/64  
**SPENCER**  
Size: 90 mm



TWS 84-3018/68  
**LITTAUER**  
Size: 135 mm



TWS 84-3018/69 TWS 84-3018/70 TWS 84-3018/71 TWS 84-3018/72  
TWS 84-3018/73  
**BEEBE**  
Size: 110 mm

TWS 84-3018/74  
**Dean**  
17cm



TWS 84-3018/75  
**1 Blade Serrated**  
Size: 120 mm



TWS 84-3018/76  
**CASTROVIEJO**  
Size: 90

Treasure Wright (U.K.) Ltd.

128-160 City Road, London, EC1V 2NX, United Kingdom  
info@twrightmedical.com



TW Surgical

# Impression Trays

Made of 18/8 Stainless Steel, Solid, Set of 10

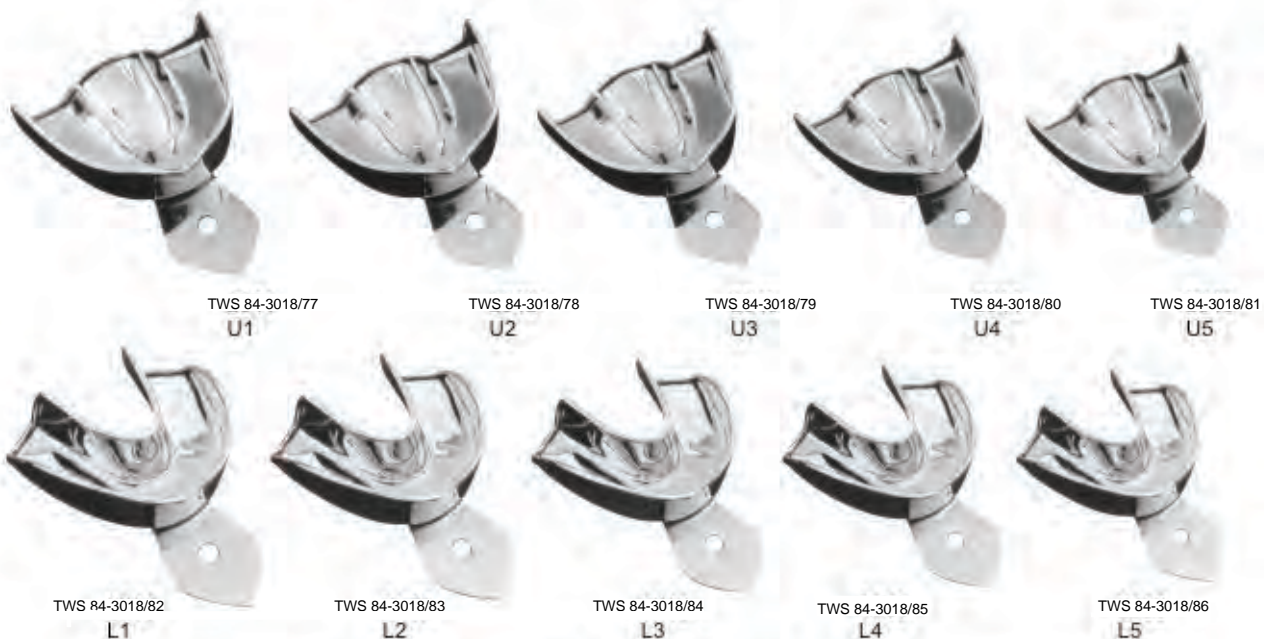

All The Above Impression Trays are Available in These 5 Sizes



UPPER		U1	U2	U3	U4	U5
	A	62	60	53	54	52
B	83	75	73	69	68	

All Dimension are in mm

LOWER		L1	L2	L3	L4	L5
	A	63	61	57	60	53
B	82	81	78	74	71	

All Dimension are in mm

## Perforated, Set of 10

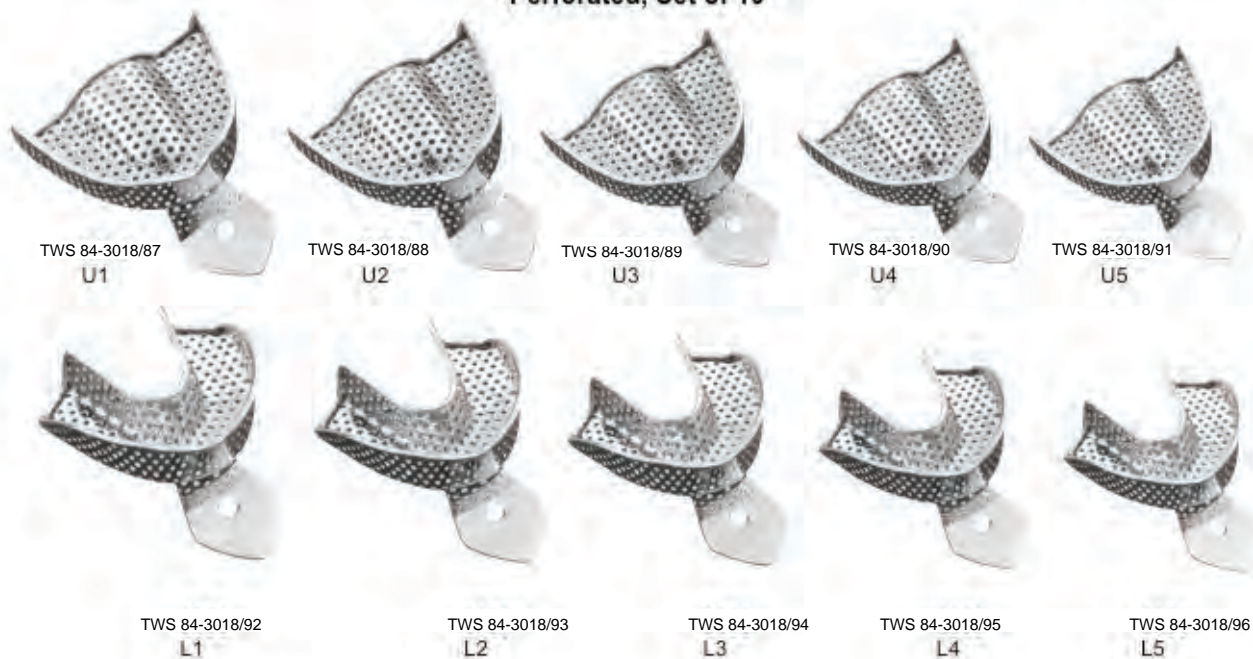

Treasure Wright (U.K.) Ltd.

128-160 City Road, London, EC1V 2NX, United Kingdom  
info@twrightmedical.com



TW Surgical

# Impression Trays

Made of 18/8 Stainless Steel, Solid Full Denture Set of 8

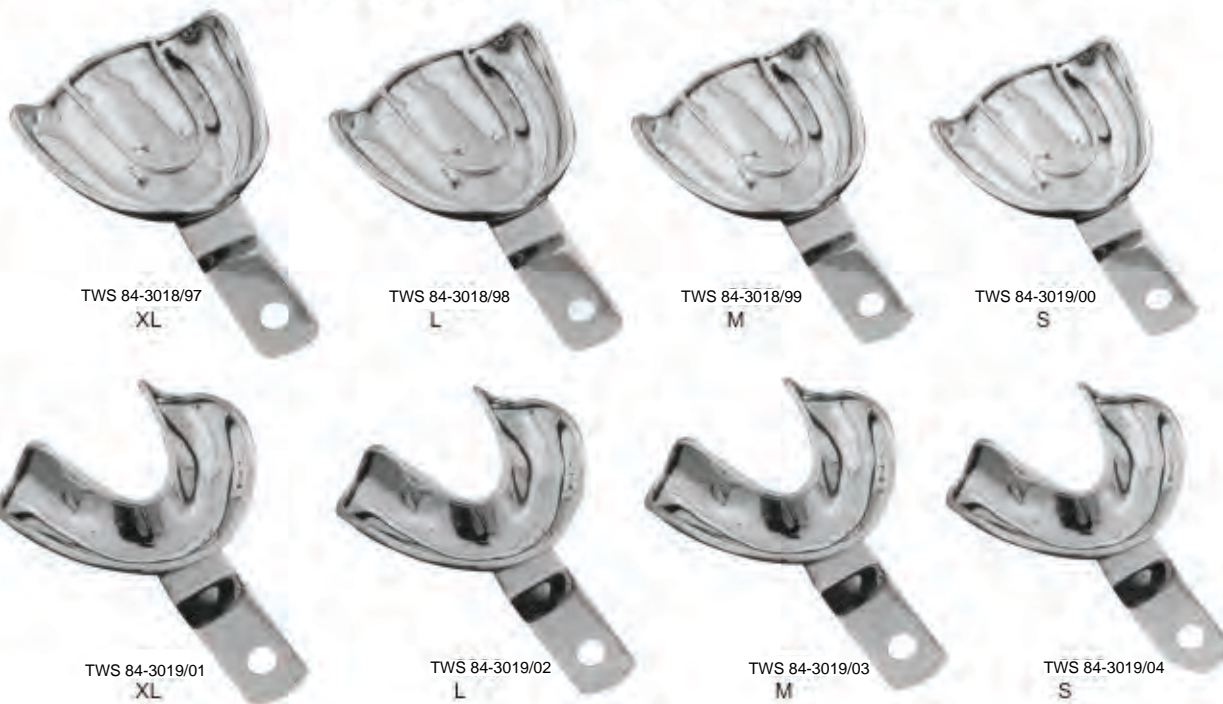

All The Above Impression Trays are Available in These 4 Sizes



UPPER		XL	L	M	S
	A	70	67	64	60
B	79	76	70	73	

All Dimension are in mm

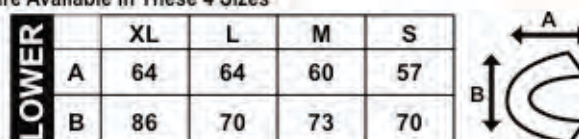

LOWER		XL	L	M	S
	A	64	64	60	57
B	86	70	73	70	

All Dimension are in mm

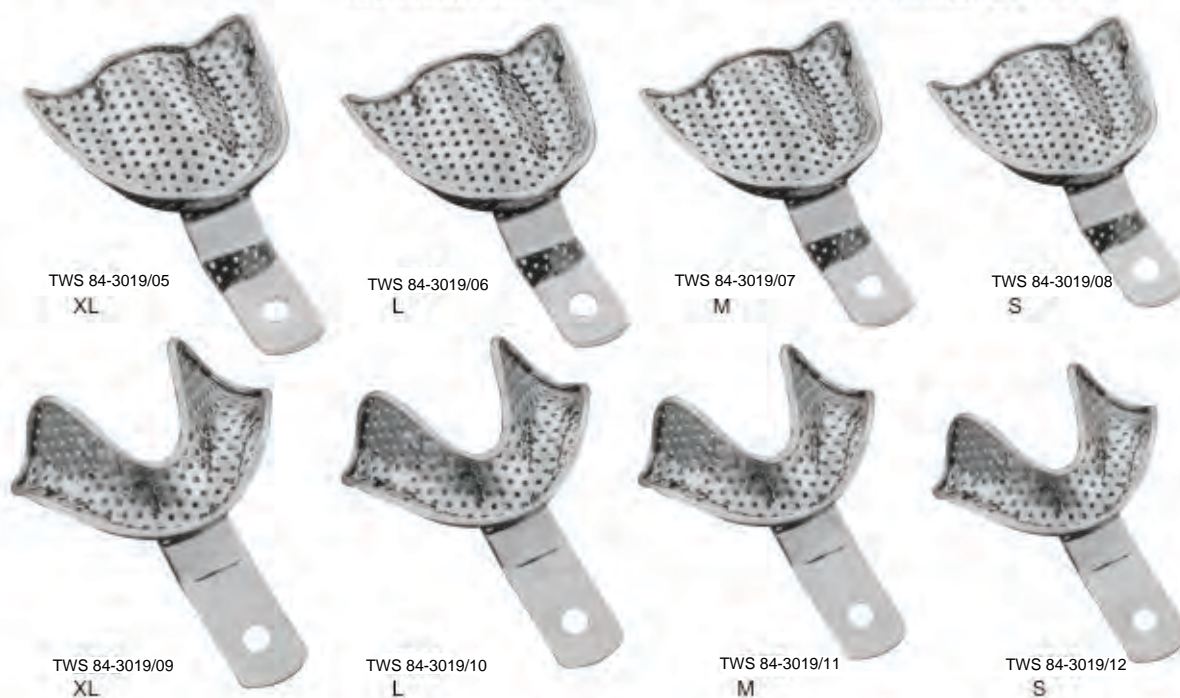

Perforated Full Denture Set of 8

Treasure Wright (U.K.) Ltd.

128-160 City Road, London, EC1V 2NX, United Kingdom  
info@twrightmedical.com



TW Surgical

# Impression Trays

Made of 18/8 Stainless Steel, Solid Set of 6



TWS 84-3019/13  
U1



TWS 84-3019/14  
U2



TWS 84-3019/15  
U3



TWS 84-3019/16  
L1



TWS 84-3019/17  
L2



TWS 84-3019/18  
L3

All The Above Impression Trays are Available in These 4 Sizes

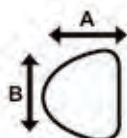

UPPER		U1	U2	U3
	A	67	64	57
B	81	71	70	

All Dimension are in mm

LOWER		L1	L2	L3
	A	60	57	54
B	81	79	76	

All Dimension are in mm

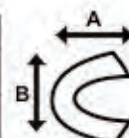

TWS 84-3019/19  
U1



TWS 84-3019/20  
U2



TWS 84-3019/21  
U3



TWS 84-3019/22  
L1



TWS 84-3019/23  
L2



TWS 84-3019/24  
L3

Perforated Set of 6

Treasure Wright (U.K.) Ltd.

128-160 City Road, London, EC1V 2NX, United Kingdom  
info@twrightmedical.com



TW Surgical

# Impression Trays

Made of 18/8 Stainless Steel, English Pattern Set of 8



TWS 84-3019/25  
Lower



TWS 84-3019/26  
Upper



TWS 84-3019/27  
Lower



TWS 84-3019/28  
Upper



TWS 84-3019/29  
Lower



TWS 84-3019/30  
Upper

All The Above Impression Trays are Available in These 4 Sizes

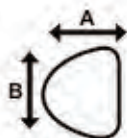

UPPER	Size	A	B	C
	0	67	50	12
	1	72	51	13
	2	78	55	15
	3	80	58	15

All Dimension are in mm



LOWER	Size	A	B	C
	0	70	50	14
	1	77	51	15
	2	79	55	15
	3	80	60	17

All Dimension are in mm

Treasure Wright (U.K.) Ltd.

128-160 City Road, London, EC1V 2NX, United Kingdom  
info@twrightmedical.com



TW Surgical

# Impression Trays

Made of 18/8 Stainless Steel, Solid Full Denture Set of 8



All The Above Impression Trays are Available in These 4 Sizes

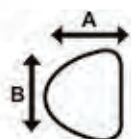

UPPER		XL	L	M	S
	A	70	67	64	60
B	79	76	70	73	

All Dimension are in mm

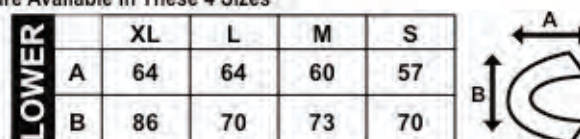

LOWER		XL	L	M	S
	A	64	64	60	57
B	86	70	73	70	

All Dimension are in mm

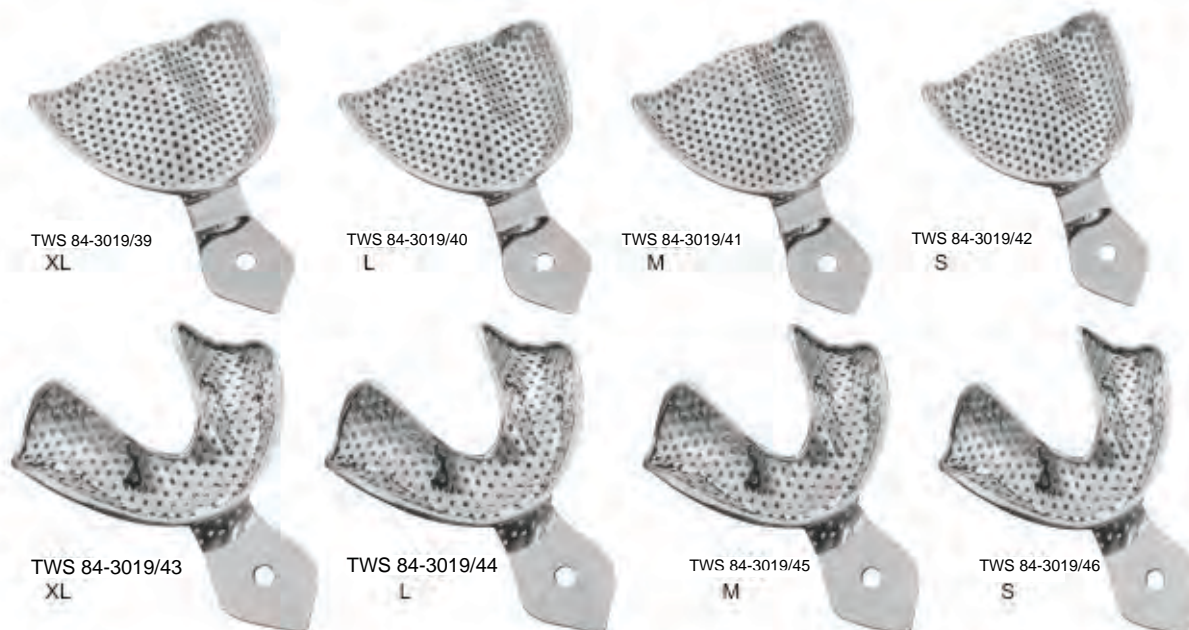

Made of 18/8 Stainless Steel, Perforated Full Denture Set of 8

Treasure Wright (U.K.) Ltd.

128-160 City Road, London, EC1V 2NX, United Kingdom  
 info@twrightmedical.com



TW Surgical

## Impression Trays

Made of 18/8 Stainless Steel, Solid Full Denture Set of 8

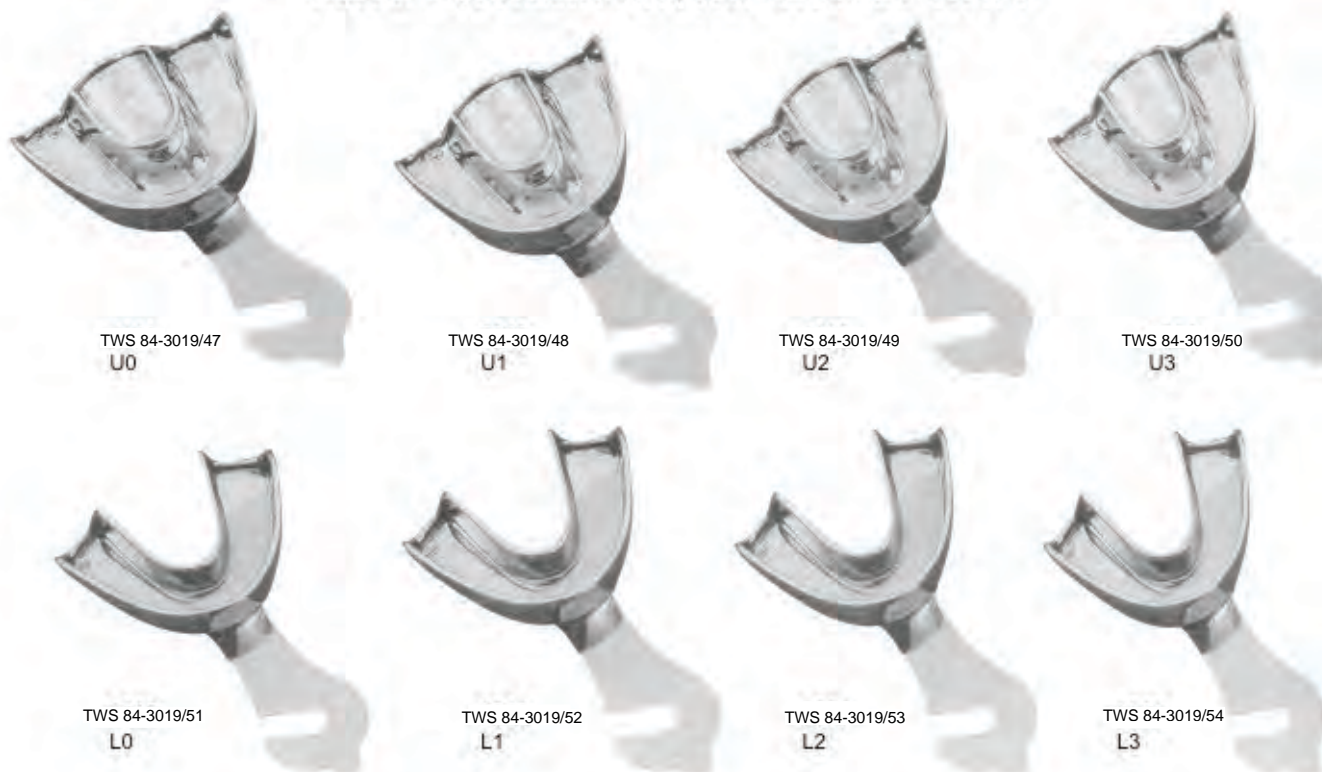

TWS 84-3019/47  
U0

TWS 84-3019/48  
U1

TWS 84-3019/49  
U2

TWS 84-3019/50  
U3

TWS 84-3019/51  
L0

TWS 84-3019/52  
L1

TWS 84-3019/53  
L2

TWS 84-3019/54  
L3

Upper Sizes: 0,1,2,3

Depth of Tray: 15,9 mm, Height of Plate: 12,5 mm

Lower Sizes: 0,1,2,3

Depth of Tray: 12,9 mm

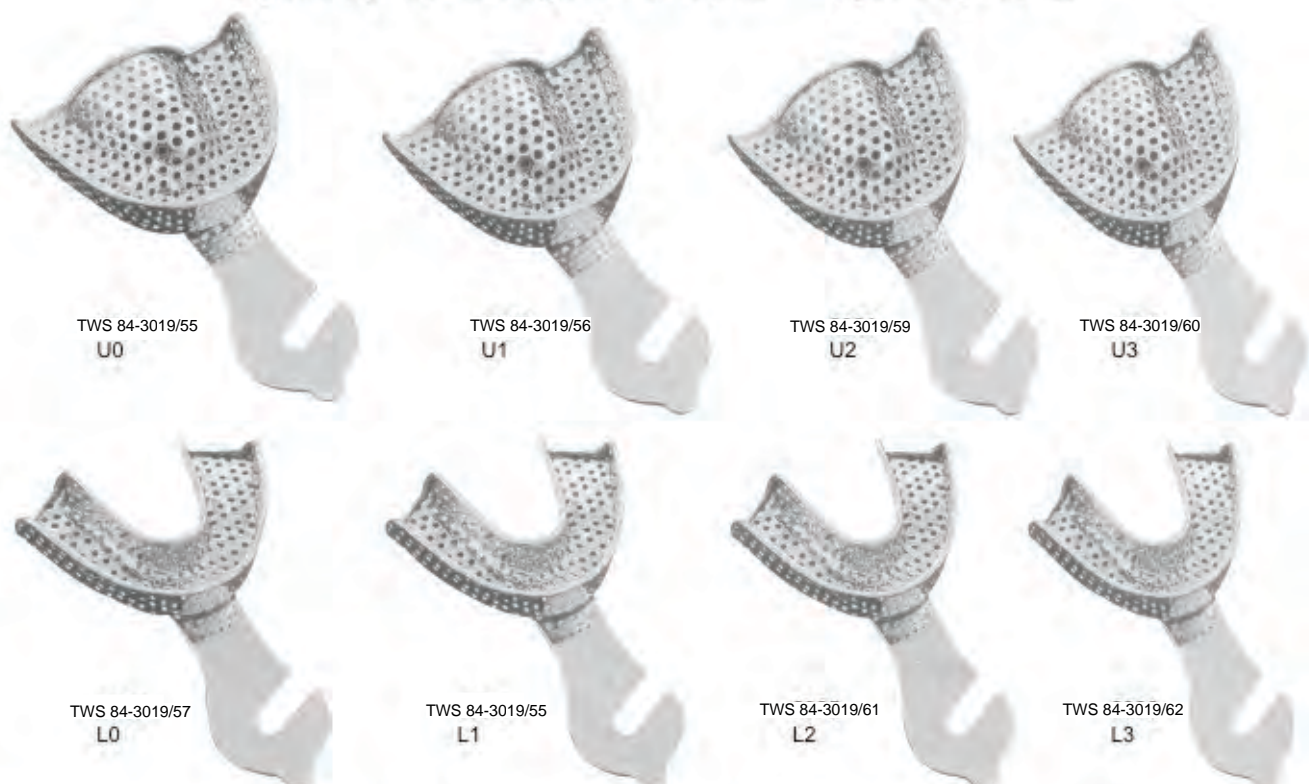

TWS 84-3019/55  
U0

TWS 84-3019/56  
U1

TWS 84-3019/59  
U2

TWS 84-3019/60  
U3

TWS 84-3019/57  
L0

TWS 84-3019/58  
L1

TWS 84-3019/61  
L2

TWS 84-3019/62  
L3

Made of 18/8 Stainless Steel, Perforated Full Denture Set of 8

Treasure Wright (U.K.) Ltd.

128-160 City Road, London, EC1V 2NX, United Kingdom  
info@twrightmedical.com



TW Surgical

# Impression Trays

## Impression Trays For Crown & Bridge Work



TWS 84-3019/63  
U1P



TWS 84-3019/64  
L1P



TWS 84-3019/65  
U1P



TWS 84-3019/66  
L1P

**SOLID**

**PERFORATED**



TWS 84-3019/67  
Adjustable  
Perforated



TWS 84-3019/68  
Adjustable  
Solid

**PERFORATED**

**SOLID**



TWS 84-3019/69

For upper right jaw  
For lower left jaw

TWS 84-3019/70

For upper left jaw  
For lower right jaw

**Available in 4 sizes**

- 1.....44 mm
- 2.....55 mm
- 3.....60 mm
- 4.....65 mm



TWS 84-3019/71

For upper right jaw  
For lower left jaw

TWS 84-3019/72

For upper left jaw  
For lower right jaw

**Available in 4 sizes**

- 1.....44 mm
- 2.....55 mm
- 3.....60 mm
- 4.....65 mm



TW Surgical

# Articulators



TWS 84-3019/74



TWS 84-3019/73



TWS 84-3019/75



TWS 84-3019/77



TWS 84-3019/76



TWS 84-3019/78

Treasure Wright (U.K.) Ltd.

128-160 City Road, London, EC1V 2NX, United Kingdom  
info@twrightmedical.com



TW Surgical

# Articulators



TWS 84-3019/79



TWS 84-3019/80



TWS 84-3019/81



TWS 84-3019/83



TWS 84-3019/85



TWS 84-3019/82



TWS 84-3019/84



TWS 84-3019/86

**Treasure Wright (U.K.) Ltd.**

128-160 City Road, London, EC1V 2NX, United Kingdom  
info@twrightmedical.com



TW Surgical

## Hollow Wares



TWS 84-3019/87  
Instruments Tray of 20 Pcs



TWS 84-3019/88  
Instruments Riddle



TWS 84-3019/89  
Instruments Tray of 7 Pcs



TWS 84-3019/90  
Instruments Tray of 10 Pcs



TWS 84-3019/91  
Instruments Tray of 5 Pcs



TWS 84-3019/92  
Instruments Tray of 5 Pcs



TWS 84-3019/93  
Instruments Tray



TWS 84-3019/94  
Instruments Tray  
Perforated



TWS 84-3019/95  
Instruments Tray  
Perforated Base



TWS 84-3019/96  
Instruments Tray  
Solid Base

Treasure Wright (U.K.) Ltd.

128-160 City Road, London, EC1V 2NX, United Kingdom  
info@twrightmedical.com



TW Surgical

# Hollowares



TWS 84-3019/97  
Pulpectomy Tray



TWS 84-3019/98  
Sterilizing Box  
Available Sizes:  
17x17x3 cm  
20x10x6 cm  
30x14x6 cm



TWS 84-3019/99  
Endo Tray Box



TWS 84-3020/00  
Finger Cup



TWS 84-3020/01  
Bur Box

TWS 84-3020/02  
Sterilizing Drum  
150x150mm  
175x175mm  
190x190mm  
200x140mm  
200x200mm  
240x120mm  
225x225mm  
240x240mm  
290x160mm



TWS 84-3020/03  
Sterilizing Drum  
280x240mm  
230x150mm  
300x250mm  
340x160mm  
350x250mm  
390x200mm  
380x300mm  
100x100mm  
150x120mm

Treasure Wright (U.K.) Ltd.

128-160 City Road, London, EC1V 2NX, United Kingdom  
info@twrightmedical.com



TW Surgical

## Sterilizing Boxes & Instruments Trays



TWS 84-3020/04  
Instruments Box



TWS 84-3020/05  
Instruments Box



TWS 84-3020/06  
Instruments Box



TWS 84-3020/07  
Instruments Sterilizer  
150x75 mm



TWS 84-3020/08  
Endodontic Box



TWS 84-3020/09  
Sterilizing Box  
320x120 mm



TWS 84-3020/10  
Instruments Tray



TWS 84-3020/11  
Instruments Tray



TWS 84-3020/12  
Instruments Tray  
(Perforated)



TWS 84-3020/13  
Instruments Tray  
Shallow(Mayo)



TWS 84-3020/14  
Scaler Tray  
20.0 x 10.0 x 1.5 cm



TWS 84-3020/15  
Scalers Tray



TWS 84-3020/16  
Scalers Tray

Treasure Wright (U.K.) Ltd.

128-160 City Road, London, EC1V 2NX, United Kingdom  
info@twrightmedical.com



TW Surgical

# Hollow Wares



TWS 84-3020/17

TWS 84-3020/18

TWS 84-3020/19

TWS 84-3020/20

Forcep and Thermometer Jars



TWS 84-3020/21

Cotton Holding Jar  
60x50 mm



TWS 84-3020/22  
Spitten Mug



TWS 84-3020/23  
Spirit Burner With Wick  
Stainless Steel 18/10  
Capacity: 150 ml, 60 ml



TWS 84-3020/24  
Spirit Burners With Wick  
Stainless Steel 18/10  
Capacity: 70ml



TWS 84-3020/25  
Dressing Jar



TWS 84-3020/26  
Dressing Jar



TWS 84-3020/27  
Irrigator (Douch Can)



TWS 84-3020/28  
Measuring Jug

Treasure Wright (U.K.) Ltd.

128-160 City Road, London, EC1V 2NX, United Kingdom  
info@twrightmedical.com



TW Surgical

# Hollow Wares



TWS 84-3020/29  
Sponge Bowl



TWS 84-3020/30  
Wash Basin  
300mm-350mm-400mm



TWS 84-3020/34  
Kick Bucket With Trolley



TWS 84-3020/31  
Sponge Bowl



TWS 84-3020/32  
Gallipot



TWS 84-3020/33  
Medicine Cup



TWS 84-3020/35  
Kidney Tray Shallow  
150mm-200mm-240mm-300mm



TWS 84-3020/36  
Kidney Tray Without Lid  
150mm-200mm-250mm-300mm



TWS 84-3020/37  
Kidney Tray With Lid  
150mm-200mm-250mm-300mm

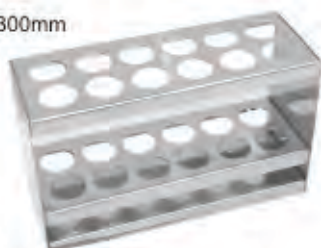

TWS 84-3020/38  
Tube Rack, Stainless Steel 18/10



TWS 84-3020/39  
Needle Case Rectangle  
Needle Case Round With Cover  
90x15



TWS 84-3020/40  
Dustbin Without Stand  
6-10-12 Ltr



TWS 84-3020/41  
Tube Rack, Round Model  
Stainless Steel 18/10



TWS 84-3020/42  
Dustbin Without Stand & Cap  
6-10-12 Ltr



TWS 84-3020/43  
Lotion Bowl With Lip  
40-60-80-100-120-150-180-200mm

Treasure Wright (U.K.) Ltd.

128-160 City Road, London, EC1V 2NX, United Kingdom  
info@twrightmedical.com



TW Surgical

## Scissors With Tungsten Carbide Inserts



TWS 84-3020/44  
Standard



14,5cm  
16,5cm  
18,5cm



TWS 84-3020/45  
Standard



14,5cm  
16,5cm  
18,5cm



TWS 84-3020/46  
Standard



14,5cm  
16,5cm  
18,5cm



TWS 84-3020/47  
Standard



14,5cm  
16,5cm  
18,5cm



TWS 84-3020/48  
Standard



14,5cm  
16,5cm  
18,5cm



TWS 84-3020/49  
Standard



14,5cm  
16,5cm  
18,5cm

Treasure Wright (U.K.) Ltd.

128-160 City Road, London, EC1V 2NX, United Kingdom  
info@twrightmedical.com



TW Surgical

# Scissors With Tungsten Carbide Inserts

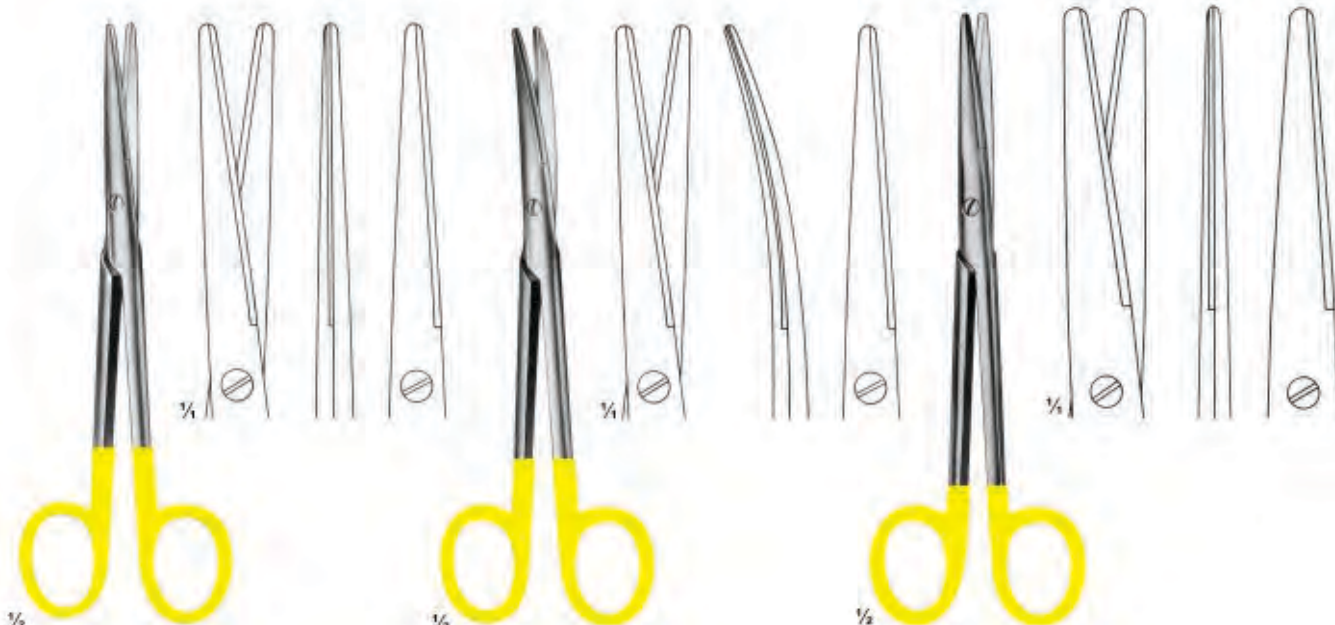

TWS 84-3020/50  
MAYO-LEXER  
Straight  
16 cm

TWS 84-3020/51  
MAYO-LEXER  
Curved  
16 cm

TWS 84-3020/52  
LEXER  
Straight  
16, 21 cm



TWS 84-3020/53  
LEXER  
Curved  
16, 21 cm

TWS 84-3020/54  
MAYO-STILLE  
Straight  
15, 17 cm

TWS 84-3020/55  
MAYO-STILLE  
Curved  
15, 17 cm

Treasure Wright (U.K.) Ltd.

128-160 City Road, London, EC1V 2NX, United Kingdom  
info@twrightmedical.com



TW Surgical

# Scissors With Tungsten Carbide Inserts



TWS 84-3020/56  
METZENBAUM  
Straight



TWS 84-3020/57  
METZENBAUM  
Curved

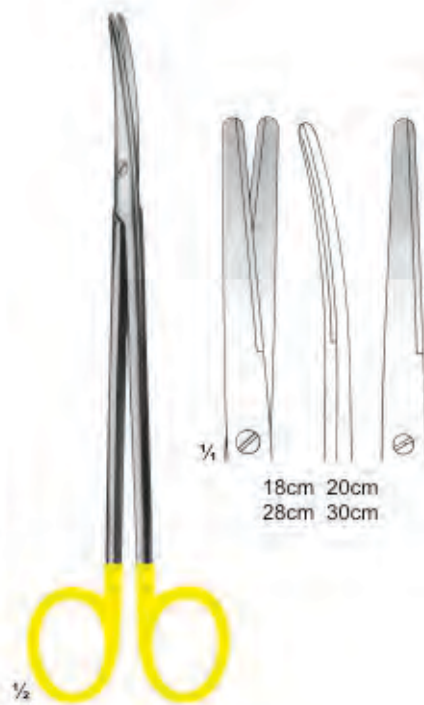

TWS 84-3020/58  
METZENBAUM  
Curved



TWS 84-3020/59  
METZENBAUM FINO  
Straight



TWS 84-3020/60  
METZENBAUM FINO  
Curved



TWS 84-3020/61  
METZENBAUM FINO  
Sharp



TWS 84-3020/62  
BRUNS  
235 mm

Treasure Wright (U.K.) Ltd.

128-160 City Road, London, EC1V 2NX, United Kingdom  
info@twrightmedical.com



TW Surgical

# Scissors With Tungsten Carbide Inserts

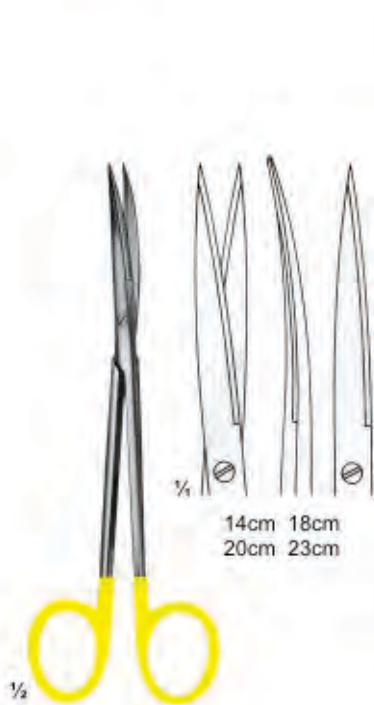

TWS 84-3020/63  
METZENBAUM FINO

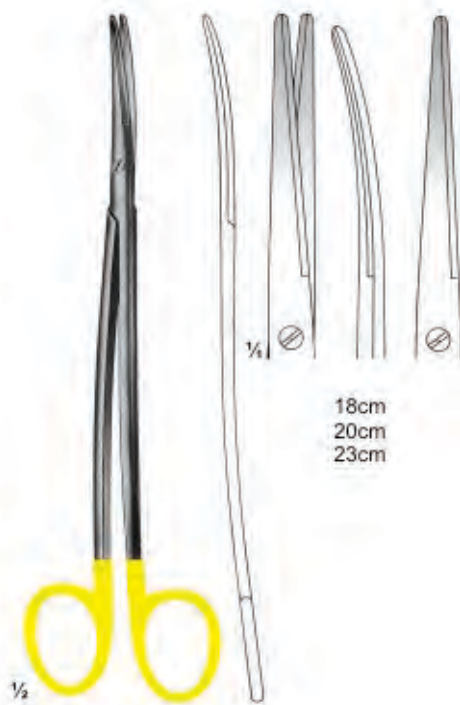

TWS 84-3020/64  
METZENBAUM FINO



TWS 84-3020/65  
METZENBAUM FINO

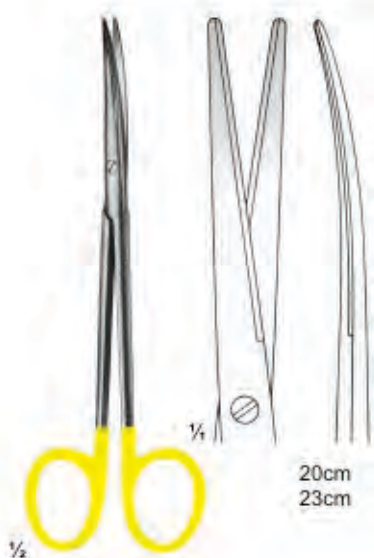

TWS 84-3020/66  
METZENBAUM FINO

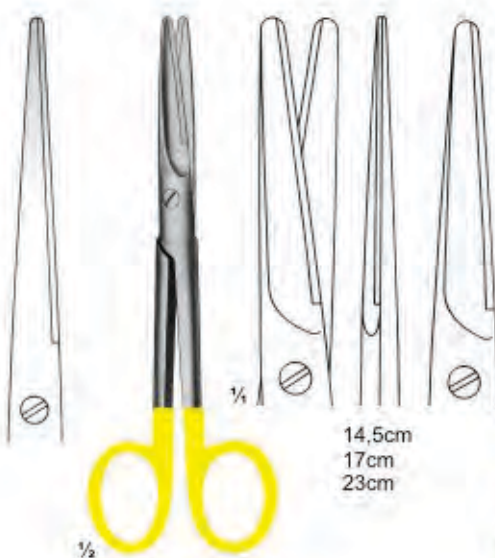

TWS 84-3020/67  
MAYO  
Straight



TWS 84-3020/68  
MAYO  
Curved

Treasure Wright (U.K.) Ltd.

128-160 City Road, London, EC1V 2NX, United Kingdom  
info@twrightmedical.com



TW Surgical

# Scissors With Tungsten Carbide Inserts



TWS 84-3020/71  
SIMS

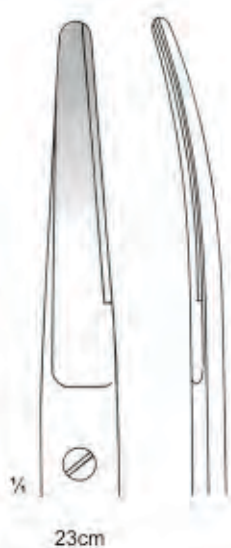

23cm

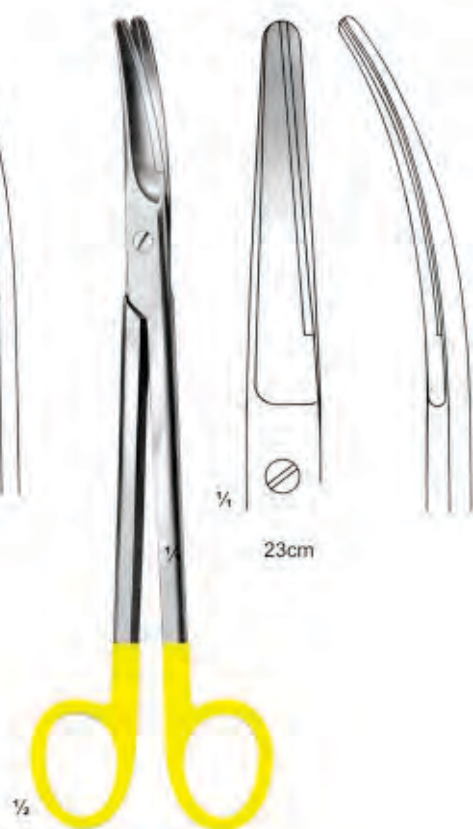

TWS 84-3020/69  
PARAMETRIUM

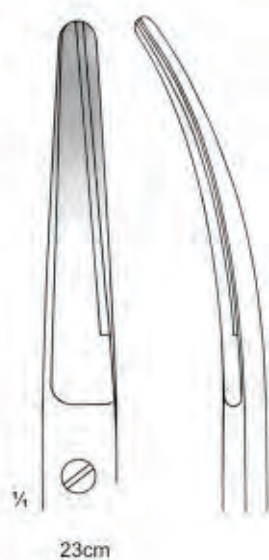

23cm

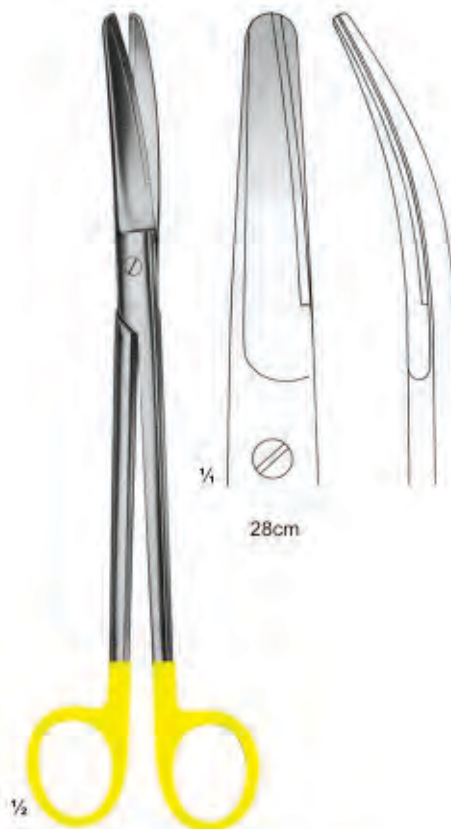

TWS 84-3020/70  
MAYO-HARRINGTON



28cm



TWS 84-3020/72  
KELLY  
Straight 16 cm



TWS 84-3020/73  
KELLY  
Curved 16 cm



TWS 84-3020/74  
DEAN  
17 cm



TWS 84-3020/75  
LAGRANGE  
Double-Curved  
11.5 cm

Treasure Wright (U.K.) Ltd.

128-160 City Road, London, EC1V 2NX, United Kingdom  
info@twrightmedical.com



TW Surgical

# Scissors With Tungsten Carbide Inserts

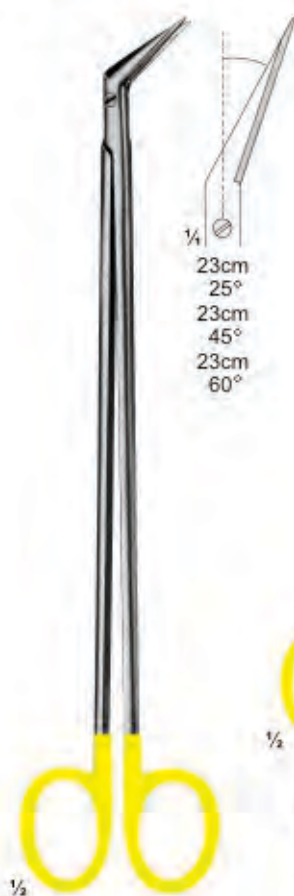

TWS 84-3020/80  
DE-BAKEY



TWS 84-3020/76  
DE-BAKEY

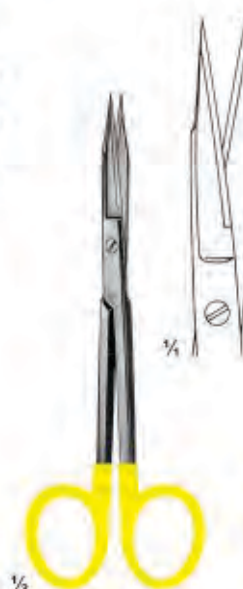

TWS 84-3020/77  
GOLDMAN FOX  
13 cm



TWS 84-3020/78  
GOLDMAN FOX  
Double-Curved  
13 cm

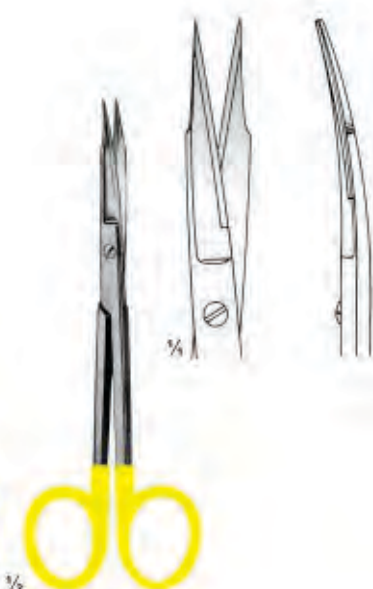

TWS 84-3020/79  
GOLDMAN FOX  
13 cm



TWS 84-3020/81  
Fine Scissors  
Straight  
11, 5 cm



TWS 84-3020/82  
Fine Scissors  
Curved  
11, 5 cm



TWS 84-3020/83  
Fine Scissors  
Angled  
11, 5 cm



TWS 84-3020/84  
RAGNELL  
Curved  
12 cm



TW Surgical

# Scissors & Dissecting Forceps With Tungsten Carbide Ins



TWS 84-3020/88  
UNIVERSAL  
12cm

TWS 84-3020/89  
Ligature Scissors  
1 Black & 1 Goldplated ring

TWS 84-3020/90  
MERIAM  
16 cm

TWS 84-3020/91  
ADSON

TWS 84-3020/92  
ADSON

TWS 84-3020/93  
CUSHING  
17,5 cm



TWS 84-3020/94  
DE BAKY  
17.5 cm

TWS 84-3020/95  
CASTROVIEJO  
Curved  
15 cm

TWS 84-3020/96  
CUSHING  
18 cm

TWS 84-3020/97  
CUSHING-  
TAYLOR  
18 cm

TWS 84-3020/98  
Dressing  
Forceps  
15 cm

TWS 84-3020/99  
SEMKEN  
15 cm

TWS 84-3020/999

Treasure Wright (U.K.) Ltd.

128-160 City Road, London, EC1V 2NX, United Kingdom  
info@twrightmedical.com



TW Surgical

# Dissecting Forceps & Needle Holders T.C Instrume

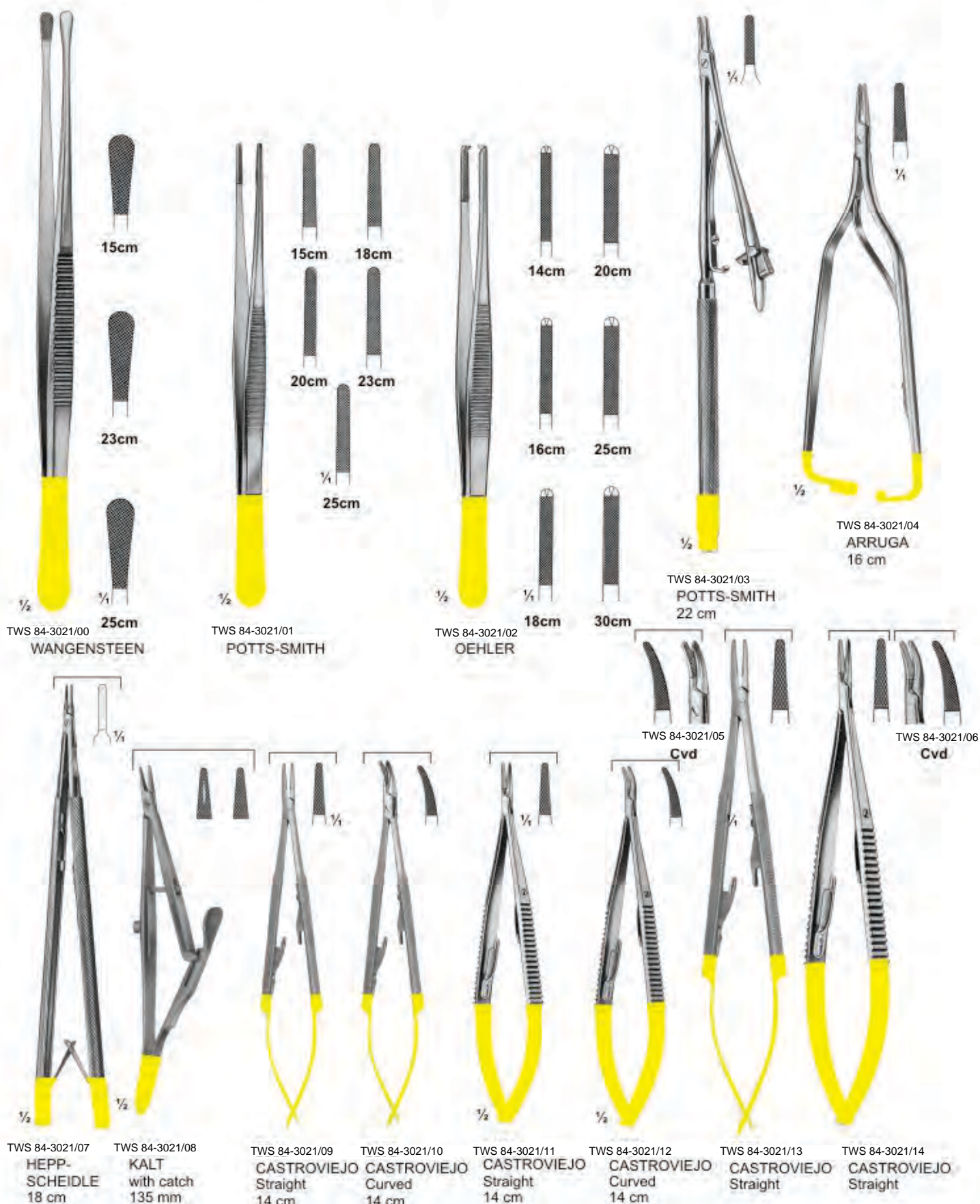

Treasure Wright (U.K.) Ltd.

128-160 City Road, London, EC1V 2NX, United Kingdom  
info@twrightmedical.com



TW Surgical

# Needle Holders With T.C. Inserts



TWS 84-3021/15  
ARRUGA  
Curved  
16 cm

TWS 84-3021/16  
CASTROVIEJO  
13 cm

TWS 84-3021/17  
HEGAR  
20,24 cm

TWS 84-3021/18  
SMOOTH TIP  
15 cm

TWS 84-3021/19  
HALSEY  
13,15 cm

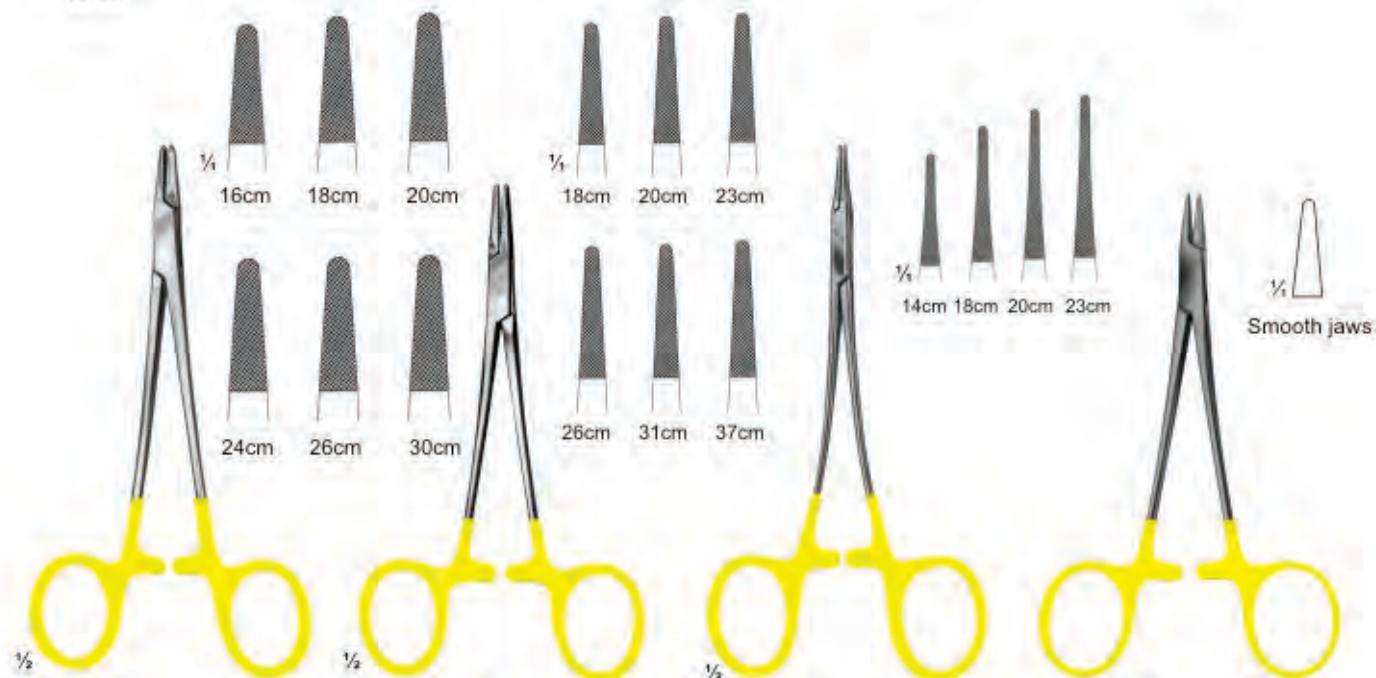

TWS 84-3021/20  
MAYO-HEGAR

TWS 84-3021/21  
DE BAKEY

TWS 84-3021/22  
HEGAR-VASCULAR

TWS 84-3021/23  
WEBSTER  
125 mm

Treasure Wright (U.K.) Ltd.

128-160 City Road, London, EC1V 2NX, United Kingdom  
info@twrightmedical.com



TW Surgical

# Needle Holders With Tungsten Carbide Inserts

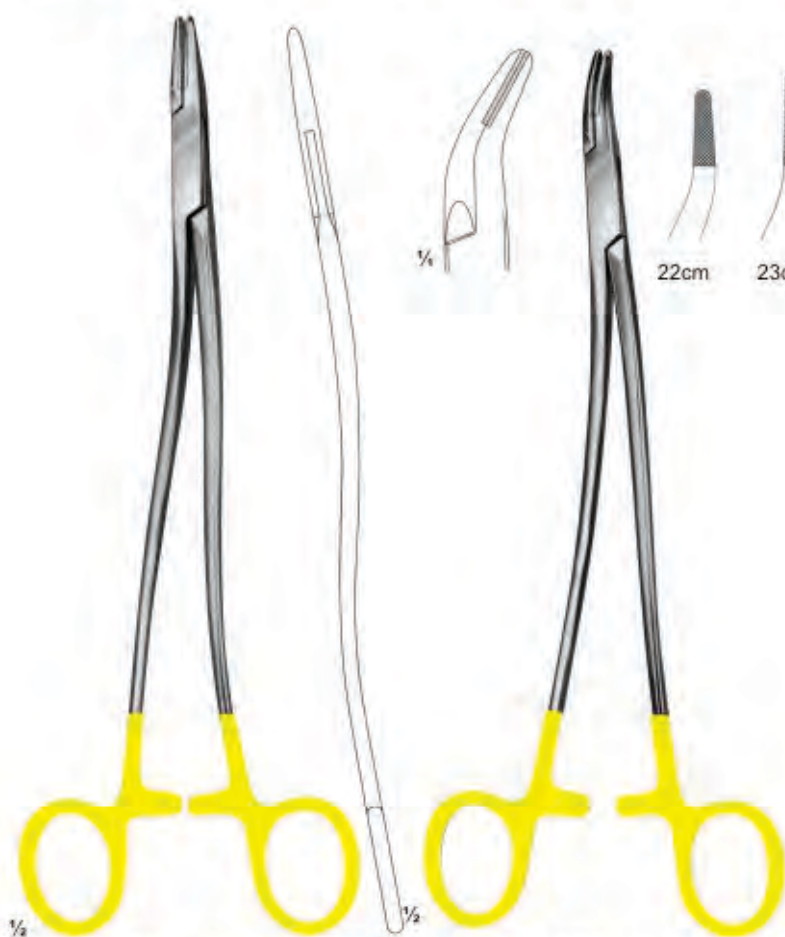

TWS 84-3021/24  
BOZEMANN-WERTHEIM  
20, 24, 26 cm

TWS 84-3021/25  
STRATTE

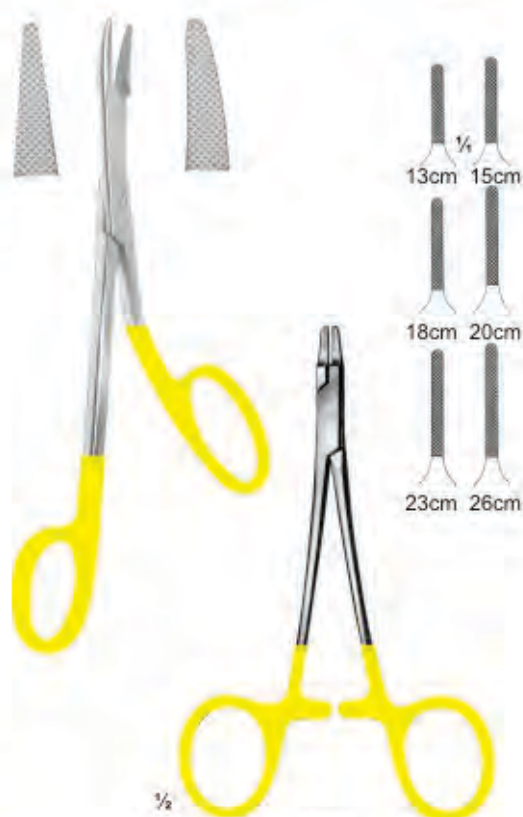

TWS 84-3021/26  
RYDER



TWS 84-3021/27  
RYDER-VASCULAR

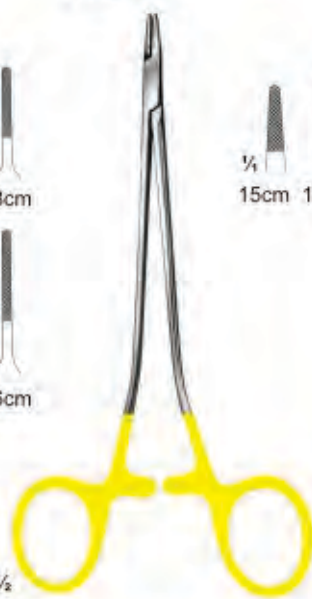

TWS 84-3021/28  
MARTIN



TWS 84-3021/29  
SAROT

Treasure Wright (U.K.) Ltd.

128-160 City Road, London, EC1V 2NX, United Kingdom  
info@twrightmedical.com



TW Surgical

# Needle Holders With Tungsten Carbide Inserts

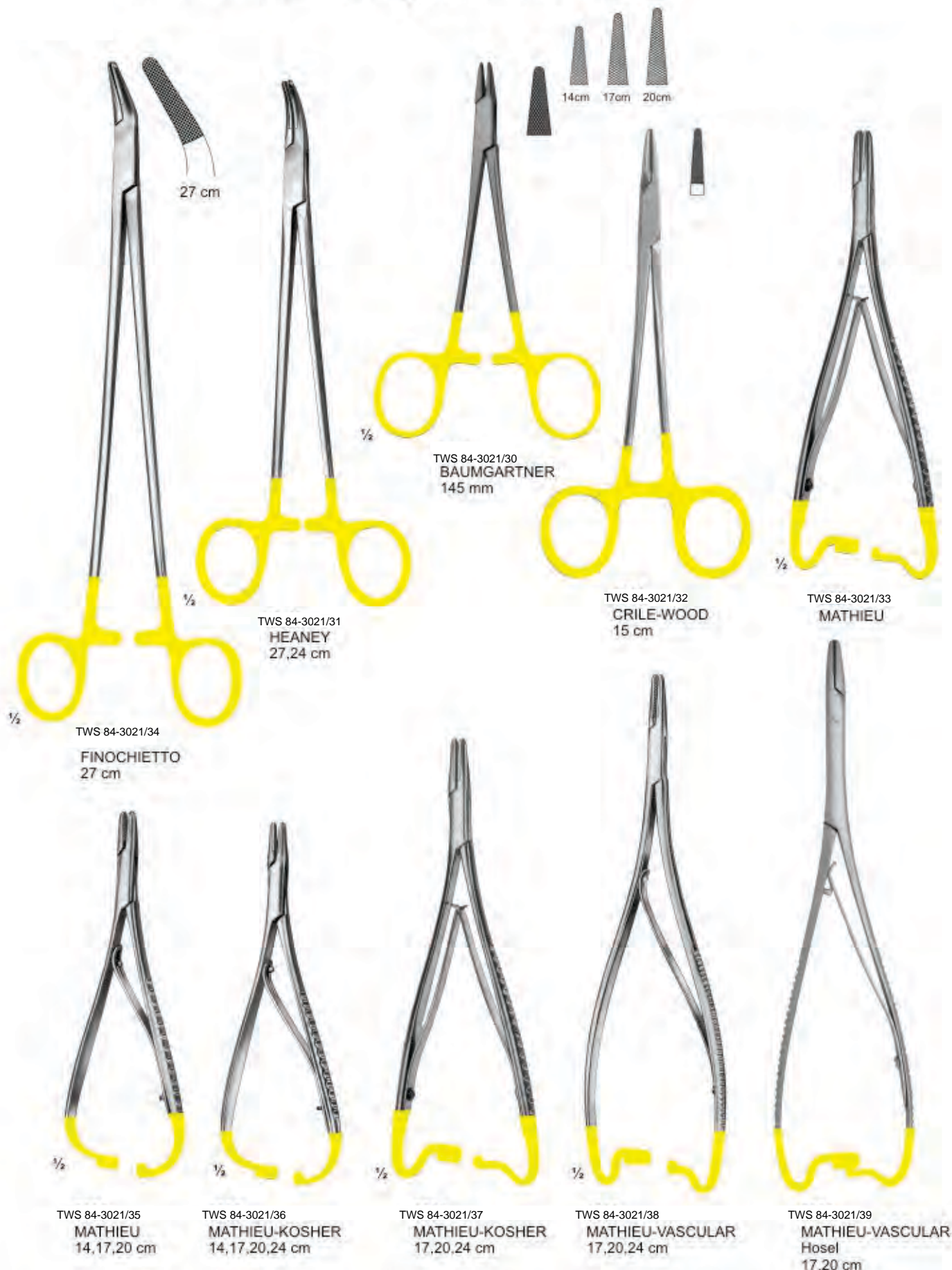

Treasure Wright (U.K.) Ltd.

128-160 City Road, London, EC1V 2NX, United Kingdom  
info@twrightmedical.com



TW Surgical

## Needle Holders With T.C. Inserts



TWS 84-3021/40  
MATHIEU-RYDER  
17,20,24 cm

TWS 84-3021/41  
**Hosel**  
Curved  
20 cm

TWS 84-3021/42  
LICHTENBERG  
20 cm

TWS 84-3021/43  
LANGHALS  
20,25 cm

TWS 84-3021/44  
LICHTENBERG  
20,25 cm



TWS 84-3021/45  
LUEHTY-BECK  
20,25 cm



TWS 84-3021/46  
LUEHTY-BECK  
20,25 cm



TWS 84-3021/47  
LANGENBECK  
18,20,23 cm



TWS 84-3021/48  
LANGENBECK  
18,20,23 cm

Treasure Wright (U.K.) Ltd.

128-160 City Road, London, EC1V 2NX, United Kingdom  
info@twrightmedical.com



TW Surgical

## Wire Cutting Plier With T.C. Inserts



TWS 84-3021/49  
**TOENNIS**  
Elastic pattern for  
dura-or intestinal suture  
180 mm



TWS 84-3021/50  
**Cutting Plier**  
12 cm

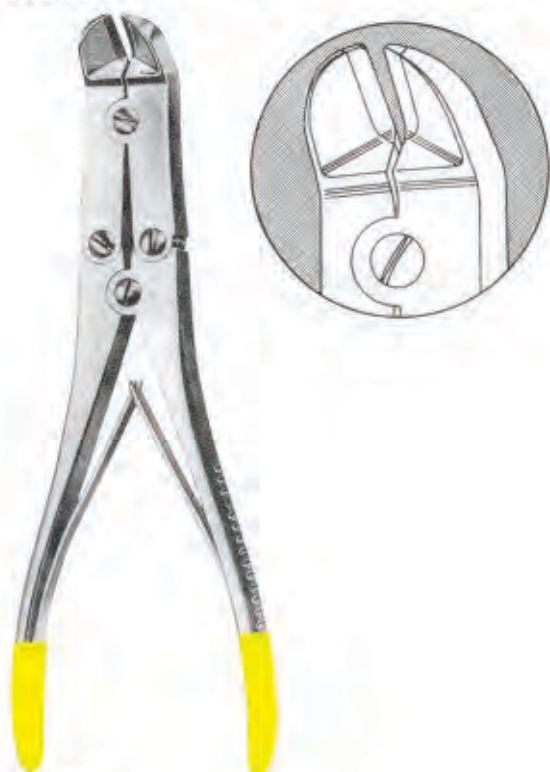

TWS 84-3021/51  
**MULLAR CLAUS**  
22 cm



TWS 84-3021/52  
**Plier**  
17.5 cm



**TW**  
Surgical

## Treasure Wright (U.K.) Ltd.

---

**Address: 128-160 , City Road,  
London EC1V 2NX. United Kingdom**

---

[www.twrightmedical.com](http://www.twrightmedical.com)

[info@twrightmedical.com](mailto:info@twrightmedical.com)



TW Surgical



**UK  
CA CE**